



Operation Manual

PRODUCT NAME

Ionizer Gun

MODEL / Series / Product Number

IZG10

SMC Corporation

Contents

Safety Instructions	3
1. How to Order	9
1-1. Ionizer	9
1-2. Accessories	9
1-3. Repair parts	10
2. How to Use	11
2-1. Procedures to operation	11
3. Wiring	12
3-1. AC adapter type/ IZG10-□01, 02	12
3-2. Power supply cable type/ IZG10-□03	12
4. Function	13
4-1. Name of parts	13
4-2. LED indication	13
4-3. Mode setting switch	14
4-4. Emitter maintenance (cleaning and replacement)	15
4-5. Alarm function	17
5. Performance	18
5-1. Installation distance and Discharge time (Discharge time of 1000V→100V)	18
5-2. Static neutralization range (Discharge time of 1000V→100V)	19
5-3. Pressure - Flow characteristics	20
6. Dimensions	20
7. Specifications	22
8. Troubleshooting	23



Safety Instructions

These safety instructions are intended to prevent hazardous situations and/or equipment damage. These instructions indicate the level of potential hazard with the labels of "Caution," "Warning" or "Danger." They are all important notes for safety and must be followed in addition to International Standards (ISO/IEC)*1), and other safety regulations.

*1) ISO 4414: Pneumatic fluid power -- General rules relating to systems.

ISO 4413: Hydraulic fluid power -- General rules relating to systems.

IEC 60204-1: Safety of machinery -- Electrical equipment of machines.(Part 1: General requirements)

ISO 10218: Manipulating industrial robots -Safety.
etc.

	Caution	Caution indicates a hazard with a low level of risk which, if not avoided, could result in minor or moderate injury.
	Warning	Warning indicates a hazard with a medium level of risk which, if not avoided, could result in death or serious injury.
	Danger	Danger indicates a hazard with a high level of risk which, if not avoided, will result in death or serious injury.

Warning

1. The compatibility of the product is the responsibility of the person who designs the equipment or decides its specifications.

Since the product specified here is used under various operating conditions, its compatibility with specific equipment must be decided by the person who designs the equipment or decides its specifications based on necessary analysis and test results.

The expected performance and safety assurance of the equipment will be the responsibility of the person who has determined its compatibility with the product.

This person should also continuously review all specifications of the product referring to its latest catalog information, with a view to giving due consideration to any possibility of equipment failure when configuring the equipment.

2. Only personnel with appropriate training should operate machinery and equipment.

The product specified here may become unsafe if handled incorrectly.

The assembly, operation and maintenance of machines or equipment including our products must be performed by an operator who is appropriately trained and experienced.

3. Do not service or attempt to remove product and machinery/equipment until safety is confirmed.

1.The inspection and maintenance of machinery/equipment should only be performed after measures to prevent falling or runaway of the driven objects have been confirmed.

2.When the product is to be removed, confirm that the safety measures as mentioned above are implemented and the power from any appropriate source is cut, and read and understand the specific product precautions of all relevant products carefully.

3. Before machinery/equipment is restarted, take measures to prevent unexpected operation and malfunction.

4. Contact SMC beforehand and take special consideration of safety measures if the product is to be used in any of the following conditions.

1. Conditions and environments outside of the given specifications, or use outdoors or in a place exposed to direct sunlight.

2. Installation on equipment in conjunction with atomic energy, railways, air navigation, space, shipping, vehicles, military, medical treatment, combustion and recreation, or equipment in contact with food and beverages, emergency stop circuits, clutch and brake circuits in press applications, safety equipment or other applications unsuitable for the standard specifications described in the product catalog.

3. An application which could have negative effects on people, property, or animals requiring special safety analysis.

4.Use in an interlock circuit, which requires the provision of double interlock for possible failure by using a mechanical protective function, and periodical checks to confirm proper operation.



Safety Instructions

Caution

The product is provided for use in manufacturing industries.

The product herein described is basically provided for peaceful use in manufacturing industries.

If considering using the product in other industries, consult SMC beforehand and exchange specifications or a contract if necessary.

If anything is unclear, contact your nearest sales branch.

Limited warranty and Disclaimer/Compliance Requirements

The product used is subject to the following “Limited warranty and Disclaimer” and “Compliance Requirements”. Read and accept them before using the product.

Limited warranty and Disclaimer

1. The warranty period of the product is 1 year in service or 1.5 years after the product is delivered, whichever is first.*2)

Also, the product may have specified durability, running distance or replacement parts. Please consult your nearest sales branch.

2. For any failure or damage reported within the warranty period which is clearly our responsibility, a replacement product or necessary parts will be provided.

This limited warranty applies only to our product independently, and not to any other damage incurred due to the failure of the product.

3. Prior to using SMC products, please read and understand the warranty terms and disclaimers noted in the specified catalog for the particular products.

*2) Vacuum pads are excluded from this 1 year warranty.

A vacuum pad is a consumable part, so it is warranted for a year after it is delivered.

Also, even within the warranty period, the wear of a product due to the use of the vacuum pad or failure due to the deterioration of rubber material are not covered by the limited warranty.

Compliance Requirements

1. The use of SMC products with production equipment for the manufacture of weapons of mass destruction(WMD) or any other weapon is strictly prohibited.

2. The exports of SMC products or technology from one country to another are governed by the relevant security laws and regulation of the countries involved in the transaction. Prior to the shipment of a SMC product to another country, assure that all local rules governing that export are known and followed.

Caution

SMC products are not intended for use as instruments for legal metrology.

Measurement instruments that SMC manufactures or sells have not been qualified by type approval tests relevant to the metrology (measurement) laws of each country.

Therefore, SMC products cannot be used for business or certification ordained by the metrology (measurement) laws of each country.

Selection

Warning

- 1) **This product is intended to eliminate static electricity from general factory automation equipment.**
If considering using the product for other applications (especially those indicated in (4) on page 3), please consult SMC beforehand.
- 2) **Do not operate beyond the specifications.**
If the product is used outside of the specifications, it may cause malfunction, failure or damage to the product, leading to an electric shock, explosion or fire.
- 3) **Use the product within the operating temperature, humidity and fluid temperature.**
Malfunction, failure, or damage to the product can result. Even within the specification range, freezing and condensation can cause malfunction, failure, or damage in environments where sudden temperature changes and temperature cycles are applied.
- 4) **Use within the specified voltage range.**
Operation with a voltage other than that specified can cause malfunction, damage to the product, electric shock or fire.
- 5) **Use clean compressed air as fluid. (Air quality Class 2.6.3 specified in ISO 8573-1: 2012 is recommended.)**
Never use flammable gas or an explosive gas as a fluid and never use this product in the presence of such gases. This may lead to fire or explosion. Please contact SMC if using for fluids other than compressed air.
- 6) **This product is not designed to be explosion proof.**
Never use in an atmosphere of potentially explosive dust, flammable gas or explosive gas. Fire or an explosion can result.

Caution

- 1) **Clean room specification is not available.**
When using in a clean room environment, confirm the required cleanliness before use.
Fine particles are generated due to wear of emitters and motor sliding during operation.

Wiring and Piping

Warning

- 1) **Before wiring, ensure that the power supply capacity meets the specification and that the voltage is within the specification. Product damage or malfunction can result.**
- 2) **To maintain product performance, the power supply should be UL Class 2 certified by National Electric Code (NEC) or evaluated as a limited power source according to UL60950.**
- 3) **The supply of power and compressed air must be stopped before wiring (including insertion and removal of the connector). Otherwise, an electrical shock or accident may occur.**
- 4) **To maintain the product performance, connect the product to ground with an earth cable or AC adapter ground terminal with a resistance of 100Ω or less. If the product is not grounded, it is not possible to secure the performance and may lead to product failure or malfunction.**
- 5) **If the power and high voltage cables are routed together, the product may malfunction due to noise. Route the Ionizer wires separately.**
- 6) **Flush the piping before connecting. Before piping this product, exercise caution to prevent particles, water drops, or oil contents from entering the piping.**
- 7) **If a valve is placed immediately before the product, instantaneous air release may occur when compressed air is supplied regardless of the trigger operation of the product.**
- 8) **Confirm that the wiring and piping are correct before supplying power and compressed air. Incorrect wiring and piping will lead to product damage or malfunction.**
- 9) **Ensure the safety of wiring and piping around the product before supplying power and compressed air.**

Handling

Warning

- 1) Mount the designated nozzle to the product.
- 2) Confirm that the nozzle is not loose or does not have play before supplying compressed air. When the nozzle is loose, tighten it by hand until it does not rotate (guideline of the tightening torque by hand: 0.1 to 0.2 N·m) Static neutralizing performance is deteriorated when the nozzle is loose.
- 3) Be sure to wear safety goggles to protect the eyes from splashed substances.
- 4) Do not direct the tip of the nozzle at the face or any other parts of the human body.
It may cause injury to personnel.
- 5) Do not use the product to clean or remove toxic substances or chemicals.
- 6) Do not drop, step on or hit the product. Otherwise, the product may be damaged.
- 7) If product is to be used in a public place, ensure product is not directed at people or used in a manner that could adversely affect the environment.
- 8) This product is not a toy.
- 9) After blowing, be sure to hang the product on a hook, etc.
- 10) Make sure that no twist, turn, tensile force or moment load is applied to the one-touch fitting, tube and power cable during use or storage. It may lead to damage or broken wire.
- 11) Do not allow foreign matter or tool to enter the ionizer nozzle.

The emitter is installed in the nozzle. If conductive objects such as metal tools or the human body either contacts or comes close to the emitter, reaction to electric shock can lead to further injuries due to collision with surrounding equipment. Also, if the tool damages the emitters, it may interfere with the specified function and performance, and may also cause operation failure or an accident.

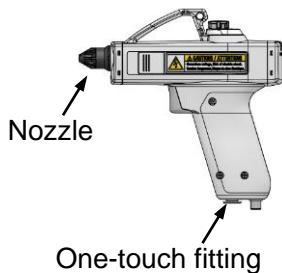

Danger High voltage

High voltage is applied to the emitters. Never touch the electrodes. Touching electrode may cause electrical shock and instantaneous rapid body motion to escape from the shock. Your body may then touch the equipment around you, causing injury.

- 12) If a valve is placed immediately before the product, instantaneous air release may occur when compressed air is supplied regardless of the trigger operation of the product.
- 13) If the supply pressure of compressed air is less than the product specification pressure (0.05MPa), the valve in the product may not open or close. Use the product with the supply pressure within the product specification value.

Operating / Storage Environment

Warning

- 1) Do not use this product in an enclosed space without ventilation.
This product utilizes the corona discharge phenomenon. A small amount of ozone and NOx will be generated. When the product is used in an enclosed space where ozone concentration increases, the smell of ozone may be uncomfortable or aggressive. Even when the room is not an enclosed space, ozone concentration increases when multiple products are used in a small space. The operating environment must always be ventilated.
- 2) Take prevention measures against ozone.
Check that all surrounding equipment have ozone protection measures in place. Perform periodic checks of the product for deterioration caused by ozone.
- 3) Supply compressed air when the product is in use.
Static neutralization is not possible without supplying compressed air. Without compressed air, the ozone or NOx generated by ion generation will stagnate and give adverse effects on the product or peripheral equipment.

4) Keep within the specified ambient temperature range.

Ambient temperature range is 0 to 40°C. Do not use the product in locations where the ambient temperature changes suddenly even within the specifications or if the temperature difference of the fluid relative to the ambient temperature is large condensation may occur.

5) Environments to avoid

Avoid using and storing this product in the following environments since they may cause damage to this product. These may cause an electric shock, fire, etc.

- a. Areas where ambient temperature exceeds the operating temperature range.
- b. Areas where ambient humidity exceeds the operating humidity range.
- c. Areas where abrupt temperature changes may cause condensation.
- d. Areas where corrosive gas, flammable gas or other volatile flammable substances are stored.
- e. Areas where the product may be exposed to conductive powder such as iron powder or dust, oil mist, salt, organic solvent, machining chips, particles or cutting oil (including water and any liquids), etc.
- f. Paths of direct air flow, such as air conditioners.
- g. Enclosed or poorly ventilated environment.
- h. Locations which are exposed to direct sunlight or heat radiation.
- i. Areas where strong electromagnetic noise is generated, such as strong electrical and magnetic fields or supply voltage spikes.
- j. Environment where static electricity is generated to the product.
- k. Locations where strong high frequency is generated.
- l. Locations which are subject to potential lightning strikes.
- m. In an area where the product may receive direct impact or vibration.
- n. Areas where the product may be subjected to forces or weight that could cause physical deformation.

6) Do not use air containing mist and/or dust.

Air containing mist and/or dust may cause performance deterioration, and reduce the maintenance cycle. Install a dryer (IDF series), air filter (AF/AFF series), and/or mist separator (AFM/AM series) to obtain clean compressed air (air quality of Class 2.4.3, 2.5.3, 2.6.3 or higher according to ISO 8573-1: 2010 (JIS B8392-1:2012) is recommended for operation.

7) The product and AC adapter are not resistant to lightning surge.**8) Influence on the implantable medical equipment.**

Electromagnetic waves emitted by this product may adversely affect implantable medical devices such as implantable cardiac pacemakers and implantable defibrillators, such as malfunctions. For precautions regarding the use of equipment or devices that may adversely affect performance, refer to the catalogue or instruction manual of the device or equipment, or contact the manufacturer directly.

Maintenance / Check

Warning

1) Perform maintenance regularly and clean the emitters.

- Check regularly that the product is not operating with undetected failures.
- The maintenance must be carried out by an operator who has sufficient knowledge and experience.
- If the product is used for an extended period of time with foreign matter on the emitters, the static neutralizing performance of the product will be reduced. Clean the product regularly. (Emitter contamination level is different depending on the installation environment and supply pressure.)
- Clean the emitter and check the static neutralizing performance when the maintenance LED is on.
- If the performance is not recovered after cleaning, it is possible that emitters are worn. Replace the emitter assembly.

2) Cleaning or replacing the emitters should never be performed while the power supply or compressed air supply are ON.

If the emitters are touched while the product is energized, this may cause an electric shock or accident.

3) Mount the emitter correctly.

If emitters are not correctly mounted, they may eject or release when compressed air is supplied.

**Danger High Voltage**

This product contains a high voltage generation circuit. When performing maintenance inspection, be sure to confirm that the power supply to the ionizer is turned off. Never disassemble or modify the product, as this can cause loss of product functionality, and there is also a risk of electric shock and earth leakage.

4) Do not directly touch the emitters.

Do not touch the end of the emitters. They have a sharp end and touching them directly with your fingers may cause injury.

5) Do not disassemble or modify the product.

Disassembling or modifying the product may cause product, electric shock or fire. The product will not be guaranteed if it is disassembled and/or modified.

6) Do not operate the product with wet hands.

It may cause electric shock or other accidents.

 **Caution**

1) Please check the following points in the regular maintenance, and replace the parts as necessary.

- a. Emitter is dirty or worn out
- b. Loosening or damage of the nozzle
- c. Squeezing or twisting of the tubing that is connected
- d. Hardening or deterioration of the tubing that is connected
- e. Air leakage

1. How to Order

1-1. Ionizer

IZG10 - 08 01 - 01

Ionizer Gun

One-touch fitting

Symbol	Applicable tube O.D.
08	ø8 (mm)
09	ø5/16" (inch)

AC adapter ^{Note 1)} / Power supply cable

Symbol	Type
01	AC adapter (with AC cord ^{Note2)})
02	AC adapter (without AC cord)
03	Power supply cable (24VDC)
N	None

Nozzle type

Symbol	Type
01	Standard nozzle
02	Bypass nozzle ^{Note3)}

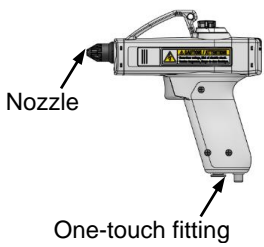
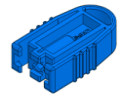
Removal tool ^{Note 4)}

Note 1) AC adapter and the power supply cable (AC adapter) are a set.

1-2. Refer to the drawing shown on the AC adapter included in the accessories.

Note 2) The AC cord is only for use in Japan. (Rated voltage 125V, plug JIS C8303, inlet IEC60320-C13)

Note 3) Comply with the statement "The requirements for dynamic flow are such that in the case when dead ending occurs a static pressure at the main orifice shall not exceed 30psi (0.21MPa)." of the OSHA 1910.242b "Hand and portable powered tools and equipment, general.". *Under supply pressure of 0.5MPa or below.
OSHA:Occupational Safety and Health Administration

Note 4) Removal tool for the emitter assembly is included in the same package.

⚠ Caution

The nozzle is specific for this product.Do not use other nozzles. Doing so will adversely affect static neutralizing performance.

1-2. Accessories

AC adapter

IZG10-CG 1

AC adapter ^{Note1)}

Symbol	Type
1	With AC cord ^{Note2)}
2	Without AC cord

Note 1) AC adapter and the power supply cable (AC adapter) are a set.

Note 2) The AC cord is only for use in Japan. (Rated voltage 125V, plug JIS C8303, inlet IEC60320-C13)

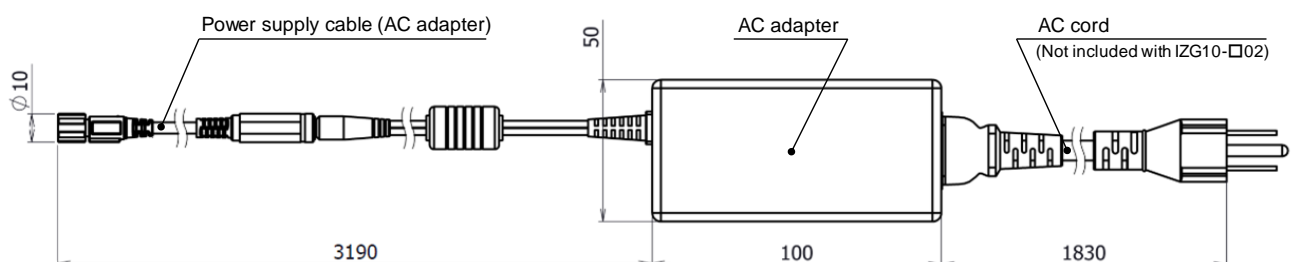

Power supply cable (24VDC)

IZG10-CP

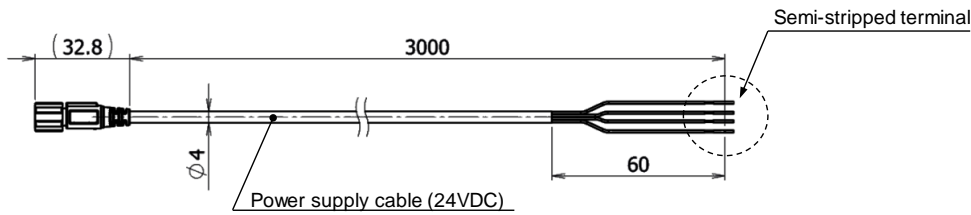

1-3. Repair parts

Emitter assembly

IZG10-NT

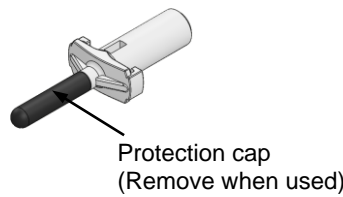

Nozzle assembly

IZG10-A001- 01

• Nozzle type

Symbol	Type
01	Standard nozzle
02	Bypass nozzle ^{Note 1)}

Note 1) Comply with the statement "The requirements for dynamic flow are such that in the case when dead ending occurs a static pressure at the main orifice shall not exceed 30psi (0.21MPa)." of the OSHA 1910.242b "Hand and portable powered tools and equipment, general."
*Under supply pressure of 0.5MPa or below.

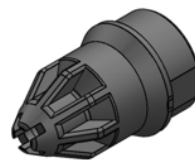

IZG10-A001-01
Standard nozzle

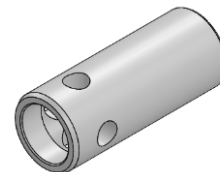

IZG10-A001-02
Bypass nozzle

Removal tool

IZG10-M1

Used when removing the emitter assembly.

This tool is included in the package. If a product is required independently, please order using the product numbers above.

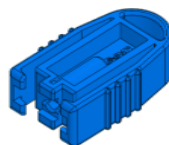

Cleaning kit

IZS30-M2

(Provided together with 1 felt pad grindstone, 1 rubber grindstone, and 2 replacement felt pads)



IZS30-A0201

(Provided together with 10 replacement felt pads)



IZS30-A0202

(Provided together with 1 replacement rubber grindstone)



2. How to Use

2-1. Procedures to operation

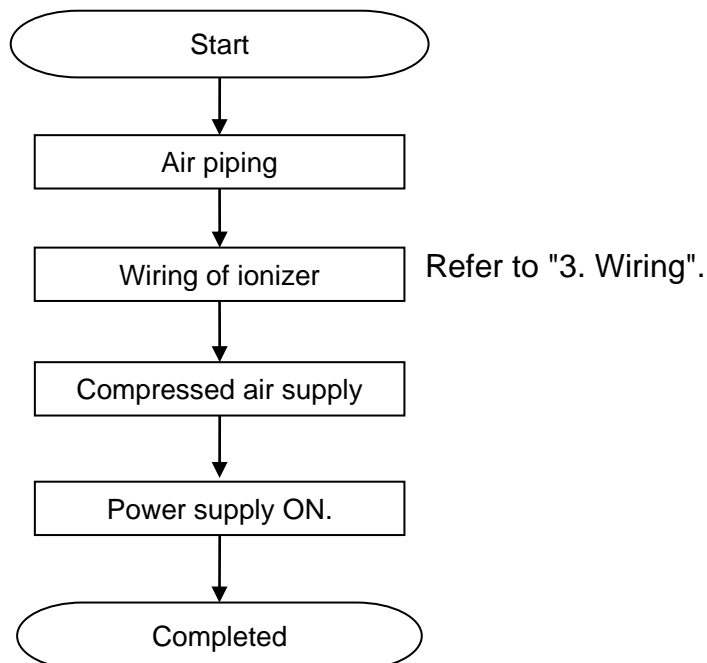

3. Wiring

3-1. AC adapter type/ IZG10-□01, 02

- Connect the M8 connector on the power cable for AC adapter to the power connector on the main unit. Connect the outlet plug with the grounding terminal of the AC cord ^{Note)} to a commercial power outlet with ground terminal (100 to 240VAC 50/60Hz).
- Connect the ground terminal correctly. The ground terminal is electrically connected to the frame ground (F.G.) of the product. The F.G. maintains the static neutralizing performance by keeping its potential the same as the reference potential.
- The input ground terminal and the output DC(-) terminal of the AC adapter (IZG10-CG1,2 ordered separately) are electrically connected. Do not connect any equipment other than this product. Otherwise, a failure or electric shock may result.

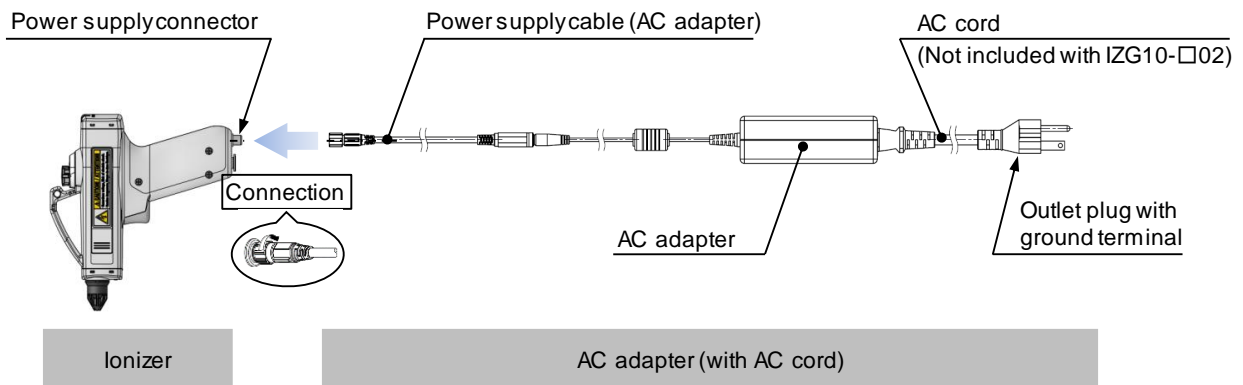

Note) The rated voltage of the AC cord supplied with IZG10-□01 is 125V, and the plug is JIS C8303 type B, which is for Japanese domestic use. If the product is used in an area other than rated voltage (220 or 240VAC), select IZG10-□02 without AC power cord and prepare an AC cord with ground terminal inlet IEC60320-C13 adapted to the power supply voltage.

3-2. Power supply cable type/ IZG10-□03

- Route the external equipment for the power supply and external switch signal input prepared by the customer according to the signal name on the power supply cable wiring table.
- Ground the green F.G. correctly. The static neutralizing performance is maintained by keeping its potential the same as the reference potential.

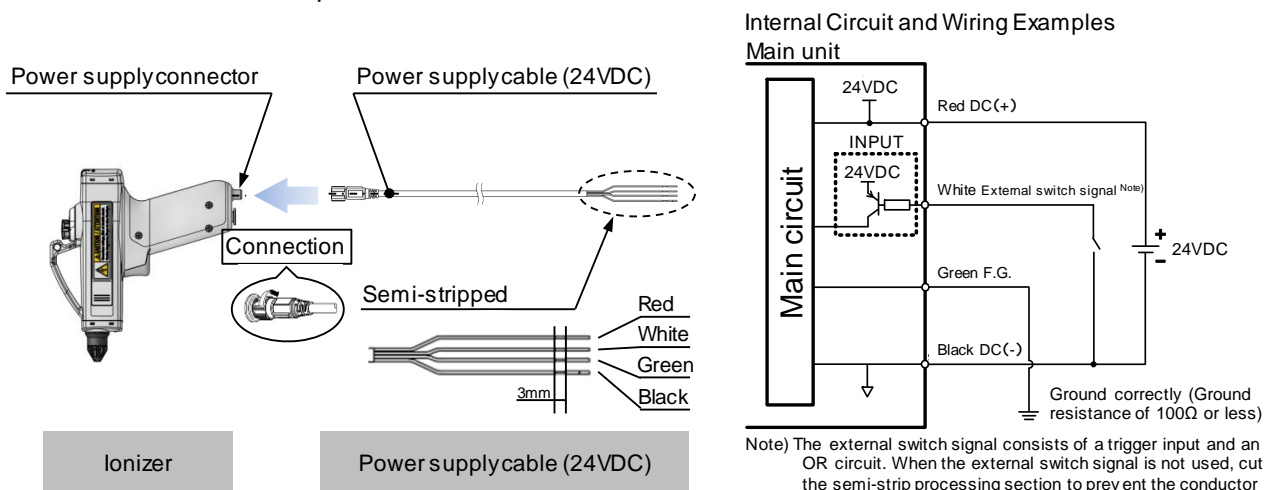

Note) The external switch signal consists of a trigger input and an OR circuit. When the external switch signal is not used, cut the semi-strip processing section to prevent the conductor from making contact.

Power supply cable wiring

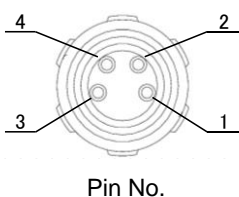

Pin No.	Signal name	Identification colour	Description
1	DC(+)	Red	Connect the power supply(+) of the product
2	External switch signal ^{Note)}	White	Blow starts by connecting with DC(-)
3	F.G.	Green	Frame ground of the product Ground resistance of 100Ω or less
4	DC(-)	Black	Connect the power supply(-) of the product

Note) The external switch signal consists of a trigger input and an OR circuit. When the external switch signal is not used, cut the semi-strip processing section to prevent the conductor from making contact.

4. Function

4-1. Name of parts

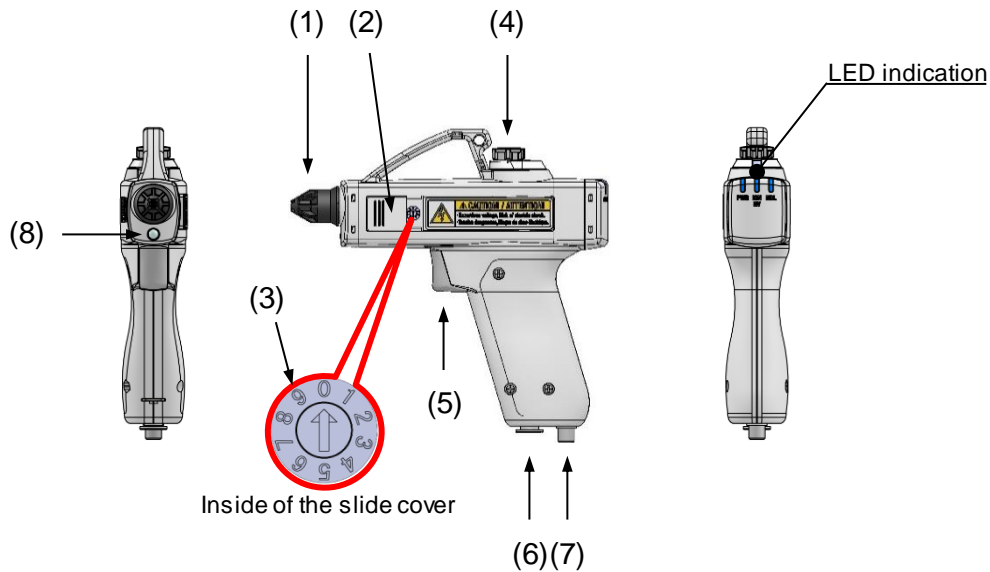

Name of parts

No.	Name	Description
(1)	Nozzle	Blows ionized air.
(2)	Slide cover	Protective cover for the mode setting switch.
(3)	Mode setting switch	Switch for setting blow and trigger. (Default setting: Setting No.0)
(4)	Flow rate adjustment handle	Adjust the flow by rotating the handle. Rotation is locked by pushing the handle.
(5)	Trigger	Switch to turn on and off static neutralization.
(6)	One-touch fitting	Compressed air supply port.
(7)	Power supply connector	Connector to input the signal for power supply, F.G. Grounding and external switch.
(8)	Operation LED	Illuminate the object during static neutralization.

4-2. LED indication

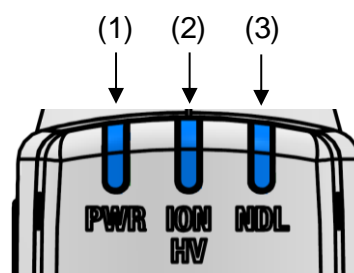

LED indication

No.	Indication	Colour	Name	Description
(1)	PWR	Green	Power supply indicator	Green LED turns ON when power is supplied, and the LED flashes when the voltage is outside of the specification range.
(2)	ION/HV	Green/Red	Ion emission/ high voltage error indicator	Green LED is ON during static neutralization. Red LED is ON when a high voltage abnormality is present.
(3)	NDL	Green	Emitter maintenance indicator	Green LED is ON when the static neutralization performance is reduced due to contamination or wear of emitters.

4-3. Mode setting switch

- Blow or trigger can be selected by switching the mode setting switch.
 - Open the slide cover over the mode setting switch and rotate the dial to the set number (No.0 to 9) ^{Note)} while referring to the table below.
 - Be sure to close the slide cover after the settings.
- Note) Default setting: Setting No.0

Table for mode setting switch

Setting No.	Blow setting	Trigger setting	
0	Continuous blow	Trigger linked	
1		Trigger locked	
2		OFF timer	3 sec
3			5 sec
4			7 sec
5	Pulse blow	Trigger linked	
6		Trigger locked	
7		OFF timer	3 sec
8			5 sec
9			7 sec

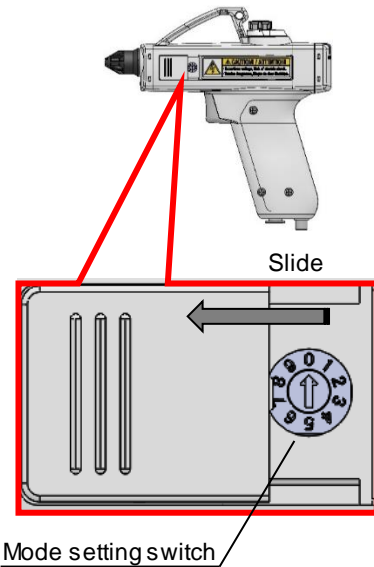

Blow setting

- Continuous blow (Set No.0 to No.4)
Blows ionized air continuously.
- Pulse blow (Set No.5 to No.9)
Blows ionized air intermittently.
Pulse frequency: 5 Hz

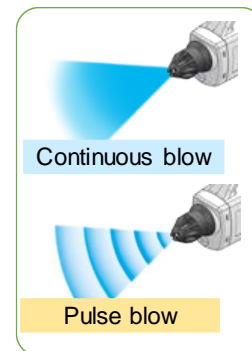

Trigger setting

Trigger ON is enabled by inputting either the main unit trigger or external switch signal.

- Trigger linked (Set No.0 and No.5)
Trigger ON/OFF and blow ON/OFF are linked.
- Trigger locked (Set No.1 and No.6)
Blow ON is maintained when trigger operation is ON
When the trigger operation is ON again, the blow is OFF.
- OFF timer (Set No.2 to No.4, No.7 to No.9)
Blow ON is maintained when trigger operation is ON
Blow is automatically OFF after the timer set time has elapsed.
Timer set time: 3 sec, 5 sec, 7 sec

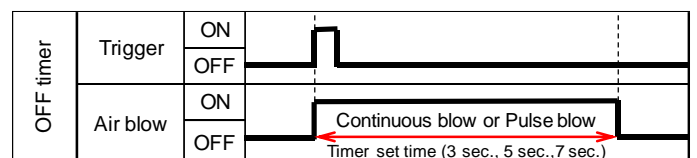
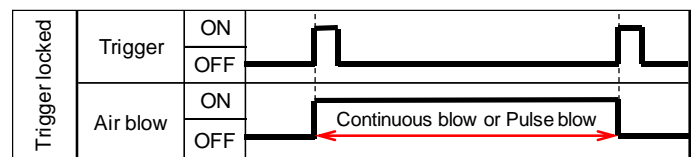
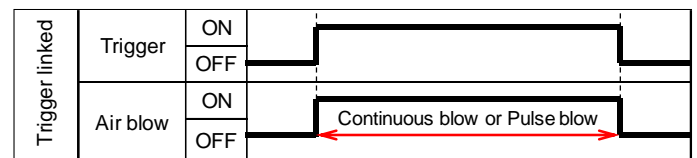

4-4. Emitter maintenance (cleaning and replacement)

- If the product is used for an extended period of time with foreign matter on the emitters, the static neutralizing performance of the product will be reduced. Clean the emitters regularly. (Emitter contamination level is different depending on the installation environment and supply pressure.)
- This product is equipped with a function that monitors the amount of discharge from the emitter and turns on the maintenance indicator LED when the amount of discharge decreases. Clean the emitter and check the static neutralizing performance when the maintenance LED is on.
- If the performance is not recovered after cleaning of the emitters, it is possible that emitters are worn. Replace the emitter assembly.
- Clean the emitters with the cleaning kit [IZS30-M2] or a cotton bud soaked in alcohol.
- Cleaning and replacement of the emitters should never be performed while the product power and compressed air are supplied. If the emitters are touched while the product is energized, this may cause an electric shock or accident.
- Since the tip of the emitter is pointed, there is a danger of injury if touched. When replacing the emitter assembly, use a tool such as pliers to avoid direct contact with the tip of the emitter.

— Cleaning of the emitter —

- Using the cleaning kit, saturate the felt with industrial alcohol, insert it into the emitters and rotate several times to clean.
- If the dirt does not come off, use the rubber grindstone to clean the emitters in the same way. After that, again use the felt saturated with industrial alcohol to finish the cleaning.
- If a cleaning kit is not available, saturate a cotton swab with alcohol ^{Note)} to clean the emitters.

Note) The industrial alcohol used should be reagent ethanol class 1 99.5vol% or greater.

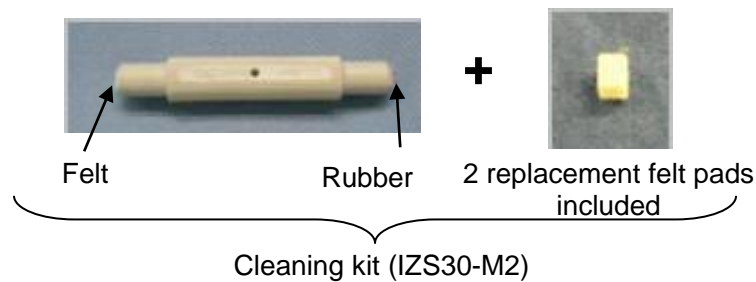

- The cleaning kit has a felt pad and a rubber grindstone. Choose the felt pad or rubber grindstone depending on the level of contamination to effectively clean the emitters. The felt and rubber grindstone can be replaced.

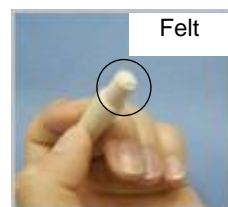

Use for normal cleaning



Use if dirt cannot be removed with felt.

— **Removing the nozzle and emitter assembly** —

- 1) Be sure to stop the power supply and compressed air supply to the product.
- 2) Remove the nozzle by turning it by hand in direction shown below.

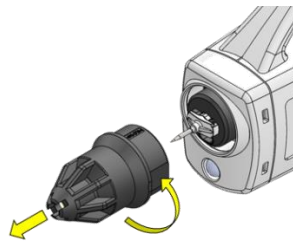

Nozzle removal

- 3) Set the removal tool to the emitter assembly, then rotate 90 degrees counterclockwise. Hold the emitter assembly and withdraw the emitter assembly towards the front.

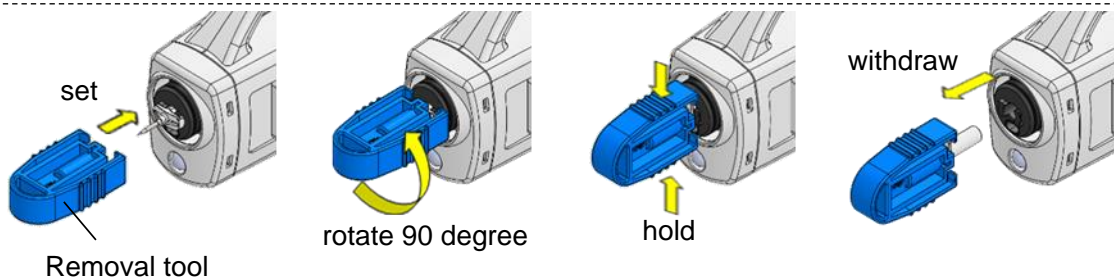

Emitter assembly removal

— **Mounting the nozzle and emitter assembly** —

- 1) Mount the replacement emitter assembly by rotating it as shown in the figure below with the protective cap attached.
- 2) Always remove the protective cap after mounting the emitter assembly.
(Be careful when removing the cap, as there is a danger of injury due to the emitter tip).
- 3) Hand-tighten the nozzle in the direction shown below until it does not turn any more.
(The recommended tightening torque by hand tightening is 0.1 to 0.2 N·m.)
Static neutralizing performance is deteriorated when the nozzle is loose.

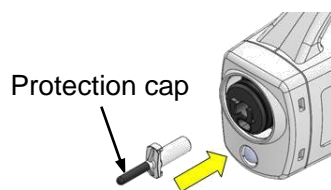

Mount the emitter assembly

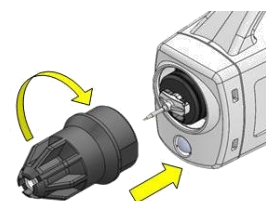

Mount the nozzle

4-5. Alarm function

If abnormal functioning occurs during operation, the user is alerted by the LED operation.

Note that ion generation may continue or stop depending on the type of abnormality.

Alarm name	Ions are generated	LED			Description	How to release error after recovery
		PWR	ION/HV	NDL		
Power supply failure	Stop	Green (flashing)	OFF	OFF	When the connected power supply voltage is outside of the specification.	Turn the power on again.
Incorrect high voltage	Stop	Green (ON)	Red (ON)	OFF	The high voltage output was reduced.	Turn the power on again.
CPU error	Stop	Green (flashing)	Red (flashing)	Green (flashing)	When CPU operates abnormally due to noise etc.	Turn the power on again.
Emitter maintenance indicator	Continue	Green (ON)	-	Green (ON)	When static neutralization performance is reduced due to contamination, wearing or breakage of emitters.	-

1) Power supply failure

- When the power supply connected to the product is not within the range of 24VDC +/-10%, the PWR LED (green) will flash to indicate the error.
- When the failure occurs, ion generation will be stopped.
- To resolve the abnormality, make sure that the power supply voltage is 24VDC +/-10%, and then turn the power back on.

2) Incorrect high voltage

- If the high-voltage output drops during operation, ION/HV LED (red) turns ON to notify the error.
- When the failure occurs, ion generation will be stopped.
- The decrease of high-voltage output could be caused by abnormal discharge due to condensation or dust on the emitters.
- In order to clear the alarm, remedy the cause of the abnormality, and supply power again.

3) CPU error

- When the CPU malfunctions due to noise, etc., the PWR (green), ION/HV (red), and NDL (green) LEDs will flash to notify the error.
- When the failure occurs, ion generation will be stopped.
- To resolve the error, supply power again after fixing the cause of the error.
- To prevent noise, perform the following actions and take countermeasures.
 1. Keep the product apart from the noise source.
 2. Route the power line and cable of the product separately.
 3. Install a noise filter to the power supply of the product.

4) Emitter maintenance indicator

- The maintenance signal is ON when static neutralization performance is decreased due to contamination, wear or damage of the emitters. The NDL LED (green) will turn ON to indicate that cleaning of the emitters or replacement needs to be performed.
- Ion generation continues even when the maintenance indicator LED is ON.
- If the emitter is worn or damaged, an alarm may be output continuously. In this case, replace the emitter assembly (IZG10-NT).

5. Performance

Performance given in this chapter is based on an electrified plate (dimensions: 150 x 150mm, electrostatic capacity: 20pF) defined by ANSI standard (ANSI/ESD STM3.1-2015). Use this data as a guideline for selection, as the performance data may vary depending on the material and size of the work piece.

5-1. Installation distance and Discharge time (Discharge time of 1000V→100V)

IZG10-□□-01, IZG10-□□-02

- Mode setting switch: Continuous blow

1) Flow rate adjustment indicator (2)

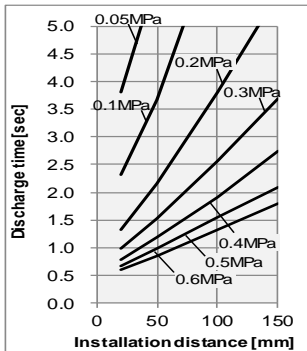

2) Flow rate adjustment indicator (4)

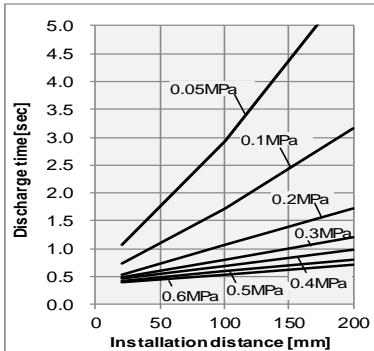

3) Flow rate adjustment indicator (6)

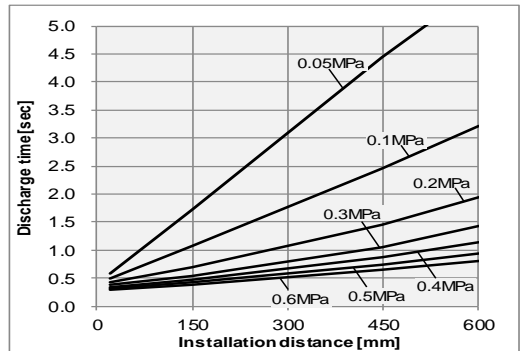

4) Flow rate adjustment indicator (maximum)

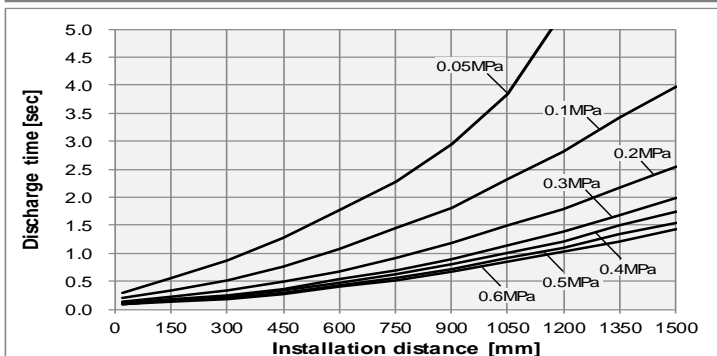

- Mode setting switch: Pulse blow

5) Flow rate adjustment indicator (2)

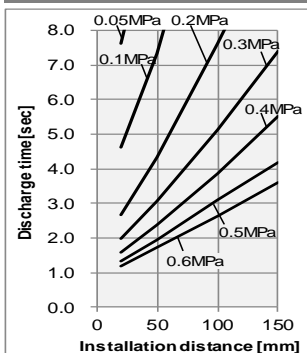

6) Flow rate adjustment indicator (4)

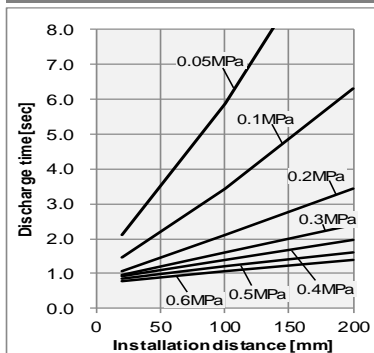

7) Flow rate adjustment indicator (6)

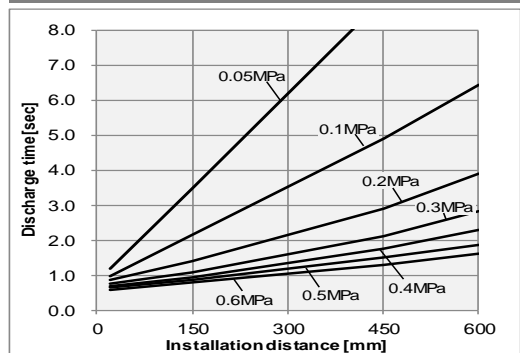

8) Flow rate adjustment indicator (maximum)

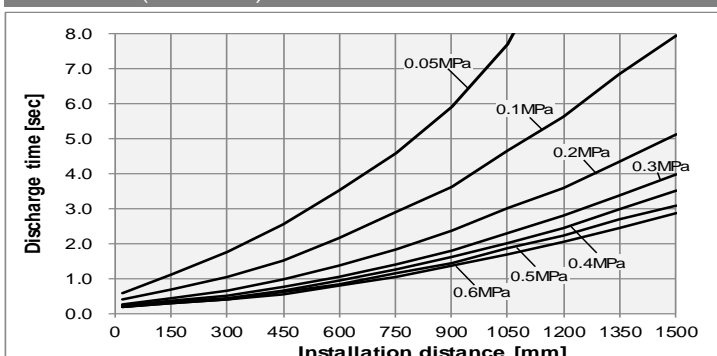

5-2. Static neutralization range (Discharge time of 1000V→100V)

IZG10-□□-01, IZG10-□□-02

- Mode setting switch: Continuous blow Flow rate adjustment indicator (maximum)

1) Supply pressure 0.05 MPa
Consumed flow rate 80 L/min (ANR)

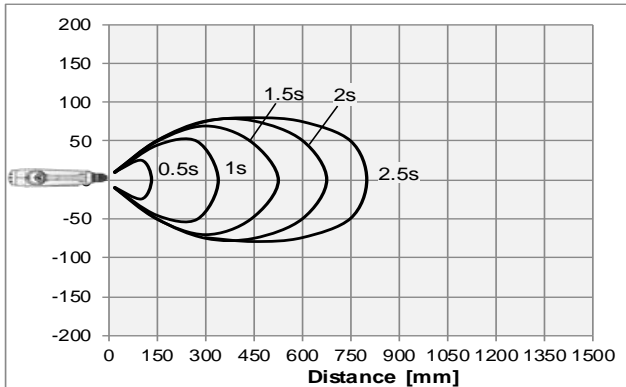

2) Supply pressure 0.1 MPa
Consumed flow rate 119 L/min (ANR)



3) Supply pressure 0.2 MPa
Consumed flow rate 188 L/min (ANR)

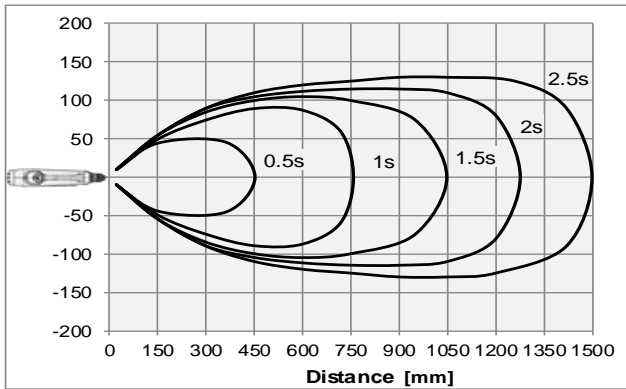

4) Supply pressure 0.3 MPa
Consumed flow rate 253 L/min (ANR)

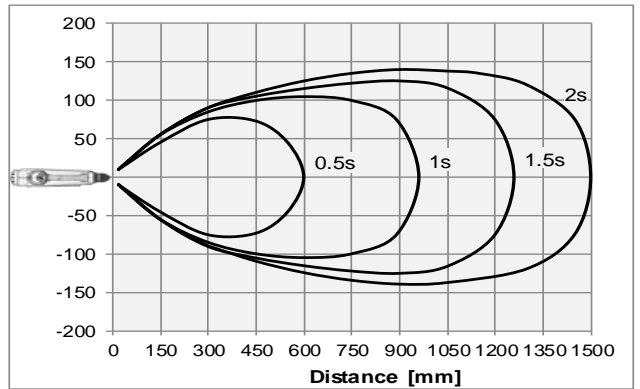

5) Supply pressure 0.4 MPa
Consumed flow rate 316 L/min (ANR)

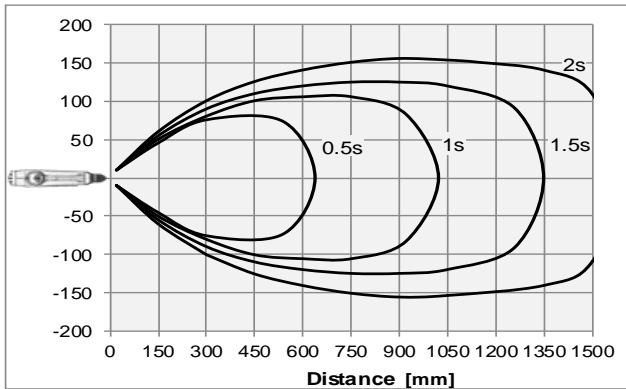

6) Supply pressure 0.5 MPa
Consumed flow rate 390 L/min (ANR)

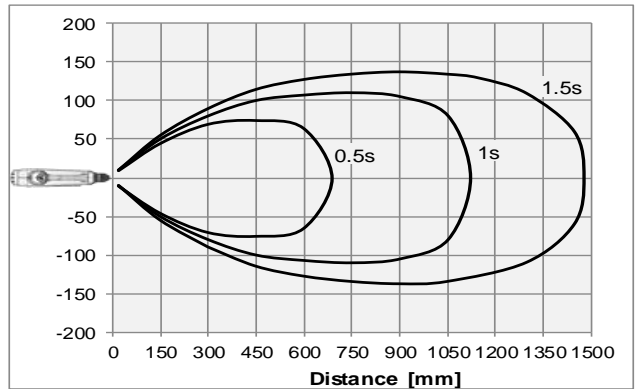

7) Supply pressure 0.6 MPa
Consumed flow rate 450 L/min (ANR)

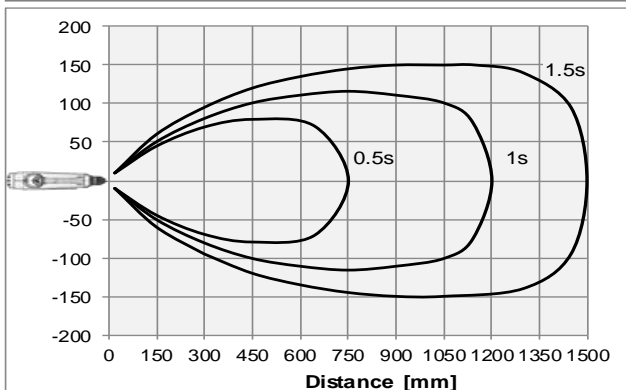

5-3. Pressure - Flow characteristics

IZG10-□□-01, IZG10-□□-02

- Mode setting switch: Continuous blow

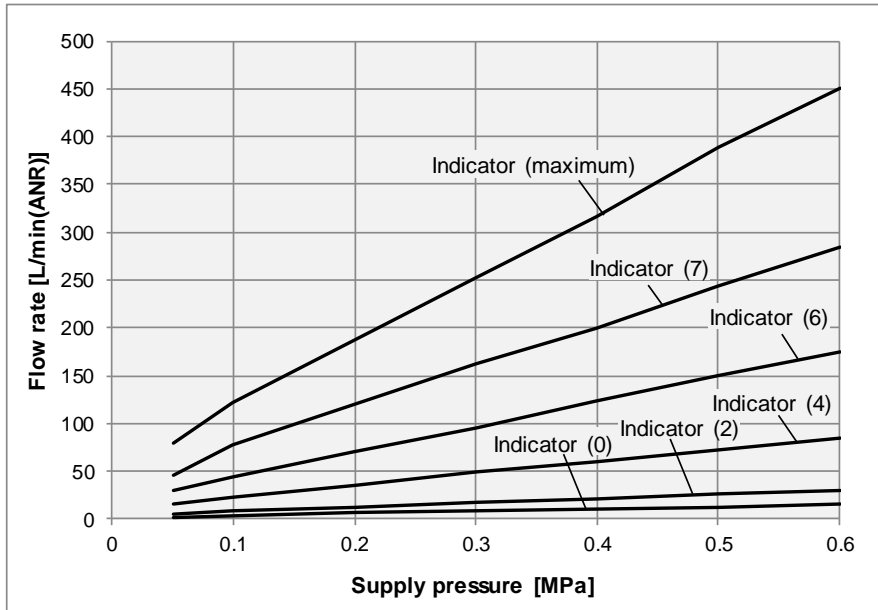

6. Dimensions

Ionizer (Standard nozzle) / IZG10-□□-01

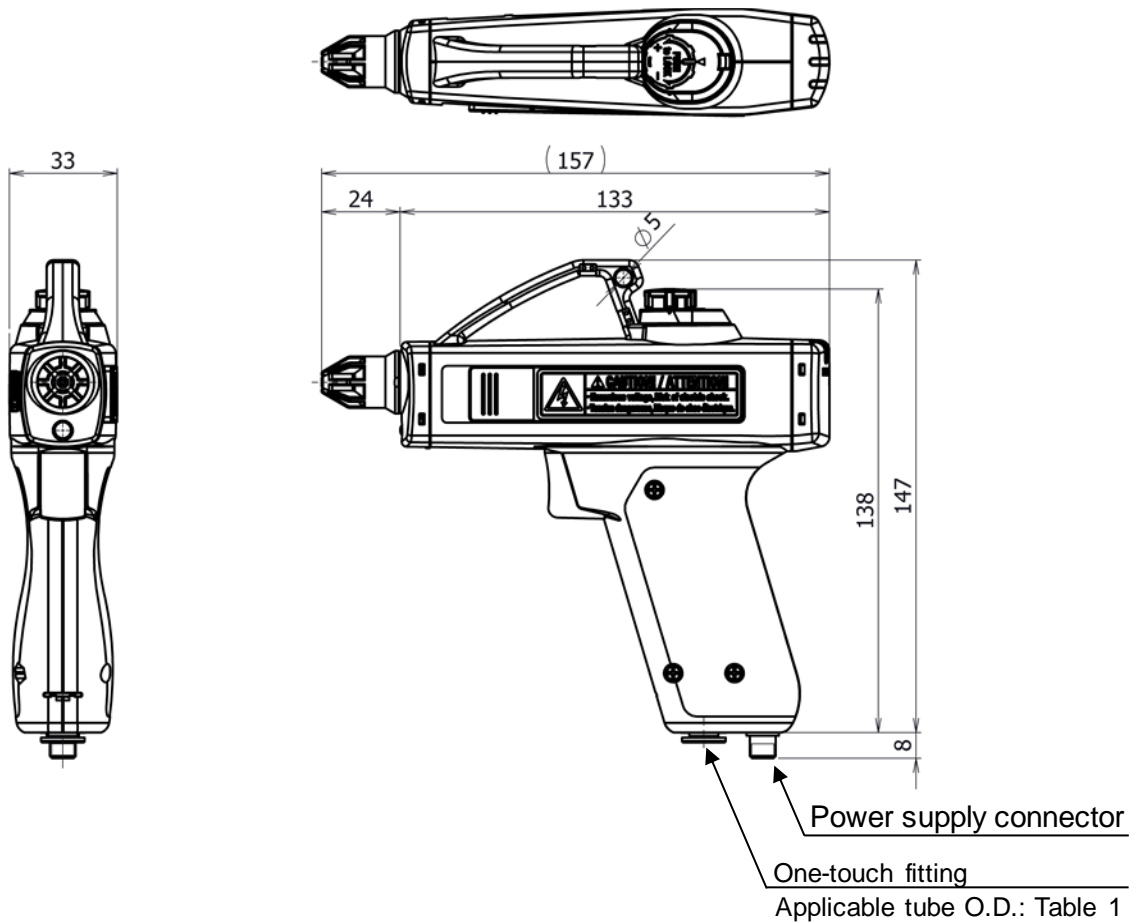
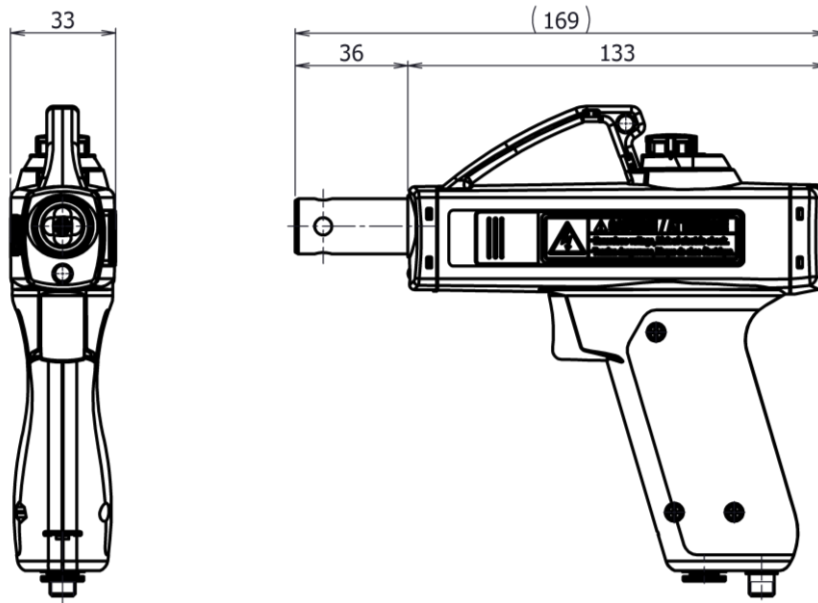

Table 1

Models	Applicable tube O.D.
IZG10-08□-01	$\phi 8$ (mm)
IZG10-09□-01	$\phi 5/16$ " (inch)

Ionizer(Bypass nozzle)/ IZG10-□□-02



AC adapter / IZG10-CG□

The AC adapter and power supply cable (AC adapter) are a set.

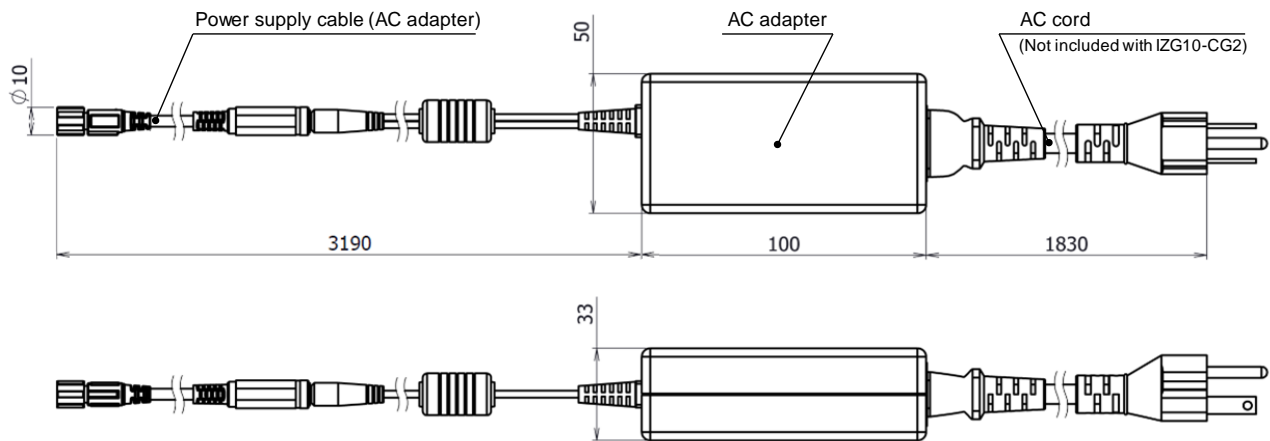

Models	AC cord
IZG10-CG1	Included
IZG10-CG2	Not included

Power supply cable (24VDC) / IZG10-CP

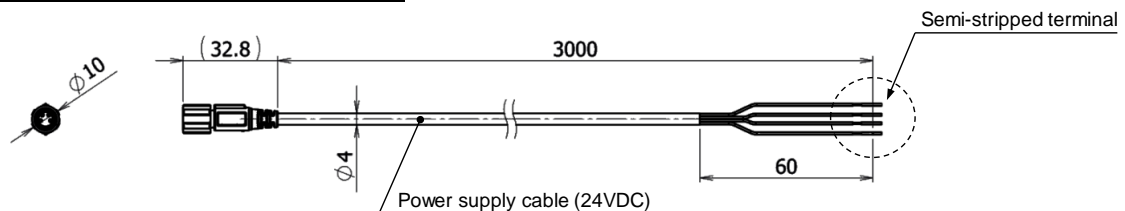

Cable specification

Number of cable wire / Size	4pcs. / AWG26
Nominal cross section of the conductor	0.15mm ²
Insulator outside diameter / Identification colour	0.85mm / Red,Black,White,Green
Sheath material	Lead-free PVC
O.D.	4mm

7. Specifications

Ionizer

Model		IZG10
Ion generation method		Corona discharge
Method of applying voltage		High frequency AC type
Applied voltage ^{Note 1)}		+/-2.5kV
Offset voltage ^{Note 2)}		Within +/-10V
Air purge ^{Note3)}	Fluid	Air (Clean dry air)
	Operating pressure	0.05 to 0.6MPa
	Connected tube O.D.	ø8(mm), ø5/16" (inch)
Power supply voltage		24VDC +/-10% (21.6 to 26.4V)
Current consumption		90mA (typ.)
Ambient temperature		0 to 40°C (No freezing)
Ambient humidity		35 to 65%Rh (No condensation)
Material		Case : PBT Emitter : Tungsten
Weight (Body)	Standard nozzle	200g
	Bypass nozzle	250g
Standard / Directive		CE

Note 1) Value measured with probe of 1,000MΩ and 5pF.

Note 2) Measurement values based on a charged plate (dimensions: 150 x 150 mm, electrostatic capacity: 20pF) defined by ANSI standard (ANSI/ESD STM3.1-2015). Distance between charged plate and ionizer: 150 mm, Air purge: 0.2 MPa.

Note 3) Static neutralization is not possible without supplying compressed air. Without compressed air, the ozone or NOx generated by ion generation will stagnate and give adverse affect on the product or peripheral equipment.

AC adapter

Model	IZG10-CG□
Input voltage ^{Note 1)}	100 to 240VAC, 50/60Hz
Output voltage	24VDC +/-5%
Output current	0.8A max
Ambient temperature	0 to 40°C
Ambient humidity	20 to 80%Rh
Applicable standard/directive	CE cUL

Note 1) AC cord for IZG10-CG1 is only for use in Japan (Rated voltage: 125V, Plug: JIS C8303, Inlet: IEC60320-C13).

8. Troubleshooting

Problem	Symptom	Check points	Possible causes	Measures
Blow does not start even when the trigger operation is turned ON.	Trigger electronic switch does not work (indicator LED is not ON)	Main unit LED display, power supply	The main power is not supplied.	Supply correct electrical power.
	Installed air operated valve does not work.	Main unit LED display, air source	Incorrect wiring	Check the wire is connected correctly referring to the wiring table.
	HV alarm stops functioning.	Main unit LED display, inside of the nozzle.	Air pressure shortage	Connect and supply air. Maintain the minimum operating pressure.
Blow does not stop even when the trigger operation is turned OFF.	External input switch signal is input	Wiring of cable	Operation stopped because HV alarm has been detected.	Solve the problem of the entry of foreign matter into the nozzle and turn on the power again.
	Continuous blow is set	Setting of the main unit (side rotary switch)	External input switch signal is connected	Cancel the input of the external switch
Pulse blow is not output	Continuous blow is set	Setting of the main unit (side rotary switch)	Continuous blow is set.	Check P13 of the operation manual and set pulse blow correctly.
	Installed air operated valve does not work.	Air source	Air pressure shortage	Ensure minimum specification pressure.
Difficult to neutralize or does not neutralize.	HV alarm stops functioning.	Main unit LED display	Operation stopped because HV alarm has been detected.	Solve the problem of the entry of foreign matter into the nozzle and turn on the power again.
	NDL alarm output	Main unit LED display	Discharge amount is reduced due to foreign matter adhering to the emitter or wear of the emitter.	Replace the emitter when repeatedly outputting an alarm, while performing maintenance on the emitter.
	Insufficient blow	Air source flow rate adjustment	Insufficient amount of blow against amount of charge	Open the flow adjustment valve to increase pressure.
	Blow is not reached	Air flow near the air source and workpiece	Ionized air does not reach the charged object due to downflow of the work environment, etc.	Open the flow adjustment valve to increase pressure.
	Interference of ionized air to the structure	Environment	Ionized air is not reached because ionized air is absorbed by a structure.	Work away from any structure
	Incomplete grounding of the frame ground.	Wiring, Ground	Potential difference is generated between the FG of the reference potential and the working environment, and ions do not reach the object properly, resulting in poor static neutralization.	Securely connect to earth with earth resistance of 100 Ω or less (earth)

Revision history

A_ Change of How to Order (addition of product number for AC adapter/ power supply cable "None" addition of the product number for nozzle type "Bypass nozzle").
Addition of the bypass nozzle and the removal tool.
B_ P1,9 Change product name (Ionizer Gun type→ Ionizer Gun).
P6 Add "without ventilation" to the end of Operating / Storage Environment section1.

SMC Corporation

4-14-1, Sotokanda, Chiyoda-ku, Tokyo 101-0021 JAPAN
Tel: + 81 3 5207 8249 Fax: +81 3 5298 5362
URL <https://www.smcworld.com>

Note: Specifications are subject to change without prior notice and any obligation on the part of the manufacturer.
© 2020 SMC Corporation All Rights Reserved