

Operation Manual

PRODUCT NAME

Teaching Box for Electric actuator

MODEL / Series/Product Number

LEC-T1 Series

Applicable models: For Series LECP6, LECPMJ
For Series LECA6
For Series LECPA (TB Ver2.1* or more)



SMC Corporation

Safety Instructions	6
Changes by teaching box version.....	8
1. Teaching Box Specifications	10
1.1 Outline and functions of the teaching box.....	10
(1)Parts descriptions and functions.....	10
(2)Keys and functions.....	11
1.2 Hardware specifications of the teaching box.....	12
(1)Hardware specifications.....	12
2. How-to-Order	13
3. Functions	14
3.1 Easy mode.....	14
(1)Functions in easy mode.....	14
(2)Tree structure of easy mode.....	15
3.2 Normal mode.....	16
(1) Functions in normal mode.....	16
(2)Tree structure of easy mode.....	18
4. System Structure.....	19
5. Procedures to Operation.....	20
5.1 Connection to teaching box.....	21
5.2 Change of display mode.....	22
(1) How to change from easy mode to normal mode.....	22
(2) How to change from normal mode to easy mode.....	22
5.3 Step data setting.....	23
(1) Setting example of step data in easy mode.....	24
(1-1) Setting example of positioning operation in easy mode (When connecting to LECP or LECA).....	25
(2) Setting example of step data in normal mode.....	26
(2-1) Setting example of step data in positioning operation (When connecting to LECP or LECA)	26
(2-1-a) TB Ver1.**	27
(2-1-b) TB Ver2.**	28
(2-2) Example of Setting step data in pushing operation (When connecting to LECP or LECA)	31
(2-2-a) TB Ver1.**	31

(2-2-b) TB ver2.**	34
(2-3) Details of “Position” setting (When connecting to LECP or LECA).....	37
(2-3-1) Number input.....	37
(2-3-2) JOG input	37
(2-3-3) Direct input	39
5.4 Operation Check.....	41
(1) Operation check by test drive	41
(2) Operation check with the monitor	41
5.4.1 Operation check by test drive.....	41
(1) Operation check by test drive in easy mode	41
(2) Operation check by test drive in normal mode.....	43
5.4.2 Operation check with monitor	45
(1) Operation check with monitor in easy mode	45
(2) Operation check with monitor in normal mode.....	46
6. Detail Functions.....	47
6.1 Step data.....	47
(1) Outline of step data	47
(2) Detail of step data setting items.....	49
(2-1) Step data setting items in positioning operation when connecting to LECP or LECA	49
(2-2) Step data setting items in pushing operation when connecting to LECP or LECA.....	50
(2-3) Step data setting items when connecting to LECPA.....	51
6.2 Detail easy mode functions.....	52
(1)Initial screen	52
(2) Easy mode “Menu”	52
(3) Easy mode “DATA”	53
(4) Easy mode “MONITOR”	56
(5) Easy mode “JOG”	56
(6) Easy mode “TEST”	58
(7) Easy mode “ALARM”	59
(8) Easy mode “SETTING”	60
6.3 Detail normal mode functions.....	62
(1) Initial screen	62
(2) Normal mode “Menu”	62
(2-1) Menu screen.....	62
(2-2) Menu items.....	62
(3) Normal mode “Step data”	63
(3-1) Step data setting screen.....	63
(3-1-a)TB Ver1.**.....	63

(3-1-b)TB Ver2.**	64
(3-2) Step data setting items	66
(3-3) Setting of "Position" (When connecting to LECP or LECA) ...	66
(3-3-1) Entry of the "position value" using number keys	67
(3-3-2) Entry of the "position value" using "JOG input"	68
(3-3-3) Entry of the "position value" using "Direct input"	70
(4) Normal mode "Parameter"	74
(4-1) Parameter group selecting screen	74
(4-2) Parameter group	74
(4-3) Parameter setting	75
(4-3-1) Parameter setting screens and how to set the parameter	75
(5) Normal mode "Test"	76
(5-1) Test selection screen	76
(5-2) Test items	76
(5-3) Test details	76
(5-3-1) "JOG/MOVE"	76
(5-3-2) "Return to origin"	78
(5-3-3) "Test drive"	80
(5-3-4) "Force output"	83
(6) Normal mode "Monitor"	86
(6-1) Monitor selecting screen	86
(6-2) Monitor items	86
(6-3) Monitor details	86
(6-3-1) "Drive" monitor	86
(6-3-2) "Output" monitor	88
(6-3-3) "Input" monitor	89
(6-3-4) "Output pin" monitor	91
(6-3-5) "Input pin" monitor	91
(7) Normal mode "Alarm"	92
(7-1) Alarm selecting screen	92
(7-2) Alarm selecting items	92
(7-3) Alarm function details	93
(7-3-1) "Active ALM"	93
(7-3-2) ALM log record	94
(7-3-3) TB alarm screen and how to reset the alarm	95
(8) Normal mode "File"	96
(8-1) File items screen	96
(8-2) File items	96
(8-3) File function details	96
(8-3-1) "Save to TB"	96
(8-3-2) "Load to Ctrl"	101
(8-3-3) "Delete"	108

(8-3-4) "Protect" (This function is only for TB Ver2.**)	108
(9) Normal mode "TB setting"	110
(9-1) TB setting screen and the setting procedure	110
(9-2) TB setting item	111
(9-3) TB setting item details	111
(10) Normal mode "Reconnect"	113
(10-1) Reconnect screen and the operating procedure	113
6.4 Common function details between normal mode and easy mode	114
(1) Axis change	114
(1-1) Axis change screen and the operating procedure	114
(2) Stop switch	115
(2-1) Stop screen and the operating procedure	115
(3) Enable switch	116
(3-1) Enable switch OFF screen and the operating procedure	116
7. Wiring of cables/Common precautions	118
8. Electric actuators/Common precautions	119
8.1 Design and selection	119
8.2 Mounting	120
8.3 Handling	121
8.4 Operating environment	122
8.5 Maintenance	123
8.6 Precautions for actuator with lock	123
9. Precautions:Controller and its peripheral devices Electric actuators/Common precautions	124
9.1 Design and selection	124
9.2 Handling	124
9.3 Installation	125
9.4 Wiring of cables/Common precautions	126
9.5 Power supply	126
9.6 Grounding	126
9.7 Maintenance	127
10. Troubleshooting	128
Appendix	130
How to change the language from Japanese to English	130

(1) TB Ver1.** 130
(2) TB Ver2.** 132



LEC-T1 Series/Teaching Box Safety Instructions

These safety instructions are intended to prevent hazardous situations and/or equipment damage. These instructions indicate the level of potential hazard with the labels of "Caution," "Warning" or "Danger." They are all important notes for safety and must be followed in addition to International Standards (ISO/IEC), Japan Industrial Standards (JIS)*1) and other safety regulations*2).

*1) ISO 4414: Pneumatic fluid power -- General rules relating to systems

ISO 4413: Hydraulic fluid power -- General rules relating to systems

IEC 60204-1: Safety of machinery -- Electrical equipment of machines (Part 1: General requirements)

ISO 10218-1992: Manipulating industrial robots -- Safety

JIS B 8370: General rules for pneumatic equipment.

JIS B 8361: General rules for hydraulic equipment.

JIS B 9960-1: Safety of machinery -- Electrical equipment for machines. (Part 1: General requirements)

JIS B 8433-1993: Manipulating industrial robots - Safety. etc.

*2) Labor Safety and Sanitation Law, etc.



Caution

Caution indicates a hazard with a low level of risk which, if not avoided, could result in minor or moderate injury.



Warning

Warning indicates a hazard with a medium level of risk which, if not avoided, could result in death or serious injury.



Danger

Danger indicates a hazard with a high level of risk which, if not avoided, will result in death or serious injury.

Warning

1. The compatibility of the product is the responsibility of the person who designs the equipment or decides its specifications.

Since the product specified here is used under various operating conditions, its compatibility with specific equipment must be decided by the person who designs the equipment or decides its specifications based on necessary analysis and test results.

The expected performance and safety assurance of the equipment will be the responsibility of the person who has determined its compatibility with the product.

This person should also continuously review all specifications of the product referring to its latest catalog information, with a view to giving due consideration to any possibility of equipment failure when configuring the equipment.

2. Only personnel with appropriate training should operate machinery and equipment.

The product specified here may become unsafe if handled incorrectly.

The assembly, operation and maintenance of machines or equipment including our products must be performed by an operator who is appropriately trained and experienced.

3. Do not service or attempt to remove product and machinery/equipment until safety is confirmed.

The inspection and maintenance of machinery/equipment should only be performed after measures to prevent falling or runaway of the driven objects have been confirmed.

When the product is to be removed, confirm that the safety measures as mentioned above are implemented and the power from any appropriate source is cut, and read and understand the specific product precautions of all relevant products carefully.

Before machinery/equipment is restarted, take measures to prevent unexpected operation and malfunction.

4. Contact SMC beforehand and take special consideration of safety measures if the product is to be used in any of the following conditions.

1) Conditions and environments outside of the given specifications, or use outdoors or in a place exposed to direct sunlight.

2) Installation on equipment in conjunction with atomic energy, railways, air navigation, space, shipping, vehicles, military, medical treatment, combustion and recreation, or equipment in contact with food and beverages, emergency stop circuits, clutch and brake circuits in press applications, safety equipment or other applications unsuitable for the standard specifications described in the product catalog.

3) An application which could have negative effects on people, property, or animals requiring special safety analysis.

4) Use in an interlock circuit, which requires the provision of double interlock for possible failure by using a mechanical protective function, and periodical checks to confirm proper operation.



LEC-T1 Series/Teaching Box Safety Instructions

Caution

The product is provided for use in manufacturing industries.

The product herein described is basically provided for peaceful use in manufacturing industries.

If considering using the product in other industries, consult SMC beforehand and exchange specifications or a contract if necessary.

If anything is unclear, contact your nearest sales branch.

Limited warranty and Disclaimer/Compliance Requirements

The product used is subject to the following “Limited warranty and Disclaimer” and “Compliance Requirements”.

Read and accept them before using the product.

Limited warranty and Disclaimer

**The warranty period of the product is 1 year in service or 1.5 years after the product is delivered.*3)
Also, the product may have specified durability, running distance or replacement parts. Please consult your nearest sales branch.**

For any failure or damage reported within the warranty period which is clearly our responsibility, a replacement product or necessary parts will be provided.

This limited warranty applies only to our product independently, and not to any other damage incurred due to the failure of the product.

Prior to using SMC products, please read and understand the warranty terms and disclaimers noted in the specified catalog for the particular products.

*3) Vacuum pads are excluded from this 1 year warranty.

A vacuum pad is a consumable part, so it is warranted for a year after it is delivered.

Also, even within the warranty period, the wear of a product due to the use of the vacuum pad or failure due to the deterioration of rubber material are not covered by the limited warranty.

Compliance Requirements

When the product is exported, strictly follow the laws required by the Ministry of Economy, Trade and Industry (Foreign Exchange and Foreign Trade Control Law).

Changes by teaching box version.

List of changes by teaching box version(TB Ver.).

*Refer to "5.1(1)" to confirm teaching box version (TB Ver.).

Change item		TB Ver2.**	TB Ver1.**
Easy mode	DATA (Step data)	<ul style="list-style-type: none"> The following item are added to data setting item of TB Ver1.** "MV MOD(Movement mode)", "InPosn(In-position)", "TrigLV(Trigger level)", "Pspeed(Pusing speed)", "Mforce(Moving force)", "Area1", "Area2" The setting item name "Force" in TB Ver1.** is changed to "Pfroce". *TB Ver2.1* or more: When connecting to LECPA, the displayed step data is No.0 only. 	Step data setting item are as following. "Posn(Position)", "Speed", "Force (Pushing force)", "Accel(Acceleration)" "Decel(Deceleration)"
	Test	When connecting to LECPA, the function "Test" cannot be used. *TB Ver2.1* or more: When connecting to LECPA, the icon "TEST" cannot be selected.	When connecting to LECPA, the function "TEST" cannot be used.
	SETTING	In "SETTING" function, the item "Reconnect" in TB Ver1.** is changed to "Language".	The item in function "SETTING" are as following. "Reconnect", "Disp", "Item"
Normal mode	Step data	<p>The editing method of step data is changed.</p> <p>It is possible to shift to another step No. easily.</p> <p>*Refer to "6.3 Detail normal mode functions (3) Normal mode "Step data"" for detail</p> <p>*TB Ver2.1* or more: When connecting to LECPA, the displayed step data is No.0 only.</p>	<p>In each step No. the step data item is set.</p> <p>*Refer to "6.3 Detail normal mode functions (3) Normal mode "Step data"" for detail</p>
	Test	<ul style="list-style-type: none"> In JOG/MOVE, when "JOG speed" and "Distance" is set, a set value is <u>not</u> registered in parameter of LEC*6 controller. In test driving, when "INP" output is turned ON only, the teaching box recognizes that the driving of tested data was finished. When connecting to LECPA, the function "Test drive" cannot be used. *TB Ver2.1* or more: When connecting to LECPA, the item "Test drive" is not displayed in "Test "menu. 	<ul style="list-style-type: none"> In JOG/MOVE, when "JOG speed" and "Distance" is set, a set value is registered in parameter of LEC*6 controller automatically. In test driving, when "BUSY" output is turned OFF and "INP" output is turned ON, the teaching box recognizes that the driving of tested data was finished. When connecting to LECPA, the function "Test drive" cannot be used.
	Monitor	TB Ver2.1* or more:	"Position" and "Speed" in "Drive"

		<ul style="list-style-type: none"> •When connecting to LECPA, the item "Input pulse" is added in "Drive" menu. •When connecting to LECPA, "Position" and "Speed" also by the unit of "pulse" and "pulse/sec" can be monitored. 	status is monitored only by the unit of "mm(or degree)" and "mm(or degree)/sec".
	File	<ul style="list-style-type: none"> •In "Load to CTRL", the loaded data depends on "parameter protect (BASIC para)" setting of the controller that data is loaded. •"Protect" function is added. *Refer to "6.3 Detail normal mode functions (8) Normal mode "File"" for detail 	•In "Load to CTRL", the loaded data doesn't depend on "parameter protect (BASIC para)" setting of the controller that data is loaded.
Common	Data Input	<p>When inputting the number/character, it is displayed as follows.</p> <p>Changing data :<u>Blink</u>.</p> <p>Final data :Not blink.</p>	<p>When inputting the number/character, it is displayed as follows.</p> <p>Changing data :Not blink.</p> <p>Final data :Not blink.</p>

1. Teaching Box Specifications

1.1 Outline and functions of the teaching box

- This teaching box is a device to input/change the setting of the connected controller.

Applicable controllers: LECP Series , LECA Series ,

LECPA Series (Teaching Box of TB Ver. 2.1* or more)

- This teaching box has two indication modes, which are “easy mode” and “normal mode”. It can be switched to the preferable mode according to the customer’s application.

Easy mode: The mode in which the minimum functions can be used. The functions can be selected from the icon. The setting of minimum operation, test drive and monitoring of the operation can be done.

Normal mode: The mode in which all the functions can be used. The functions can be selected from the displayed list. Detail setting, test drive and monitoring of the operation/signal can be done.

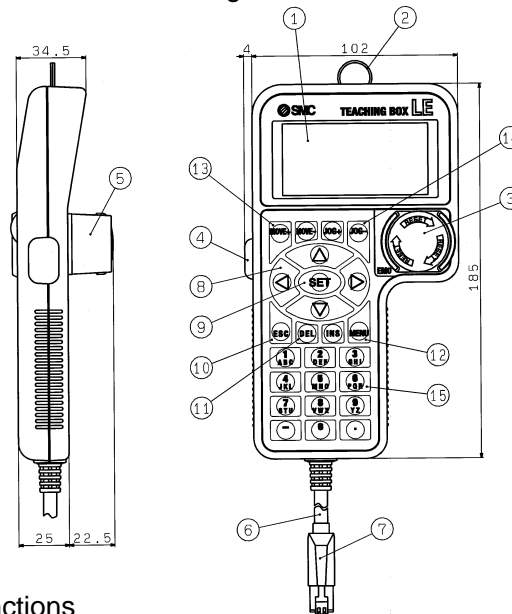

(1)Parts descriptions and functions

No.	Description	Function
①	LCD	A screen of crystal liquid display with back light (Automatically lights off after no operation for 2 minutes, returns by key input)
②	Ring	A ring for hanging the teaching box.
③	Stop switch	Locks and stops operation when this switch is pressed. The lock is released when it is turned to the right.
④	Enable switch (Option) <u>□The parameter setting of the controller is necessary to activate the enable switch.</u> <u>Refer to “6.4 (3) Enable switch” for detail.</u>	A 3-position switch conforming to the robot standard. It permits the motor operation instruction from the teaching box only when it is ON in the intermediate position of the switch. (The servo OFF is maintained when the switch is in the OFF position.) The enable switch is the switch that allows the actuator to move only when Test drive or JOG/MOVE function is executed by teaching box.
⑤	Stop switch guard	A guard which prevents malfunction of the stop switch
⑥	Cable	Length: 3 meters
⑦	Connector	A connector connected to CN4 of the controller.

(2)Keys and functions

No.	Description	Function
⑧	Up and down, right and left key	Changes the selected item.
⑨	SET key	Decides the selected item or value (letter) and register. It is necessary to press this key to determine the input value/letter otherwise it will be cancelled and not registered to the controller.
⑩	MENU key	Jumps to the menu screen.
⑪	ESC key	Changes the axis or goes back to the last screen.
⑫	DEL key	Deletes one number (letter) on the cursor.
⑬	MOVE+, MOVE- key	The key is enabled when: <ul style="list-style-type: none"> { Normal mode/ step data/ position/ Jog input { Normal mode/ test/ JOG MOVE, and instructs to move when it is pressed. MOVE+: Moves at the set speed for the set distance when pressed once. MOVE-: Moves at the set speed for the set distance x (-1) when pressed once.
⑭	JOG+, JOG- key	The key becomes valid when: <ul style="list-style-type: none"> { Normal mode / Step data / Position / Jog input { Normal mode / Test / JOG MOVE { Easy mode / JOG, and instructs to move while it is pressed. JOG+: Moves continuously at the set speed while being pressed. JOG-: Moves continuously in the opposite direction at the set speed while being pressed.
⑮	Alpha / number key "0 to 9" "A to Z" "_" "."	Allows entry using the keypad. Eg) "-12.3" → "1", "2", ".", "3", "-" Entry of alpha character: To enter a character which is printed on the key by pressing the key for multiple times until it is displayed on the screen or Shifts to the next letter by pressing the left or right key. It is used when entering parameter or step data for which characters can be entered and for names of the parameter files. Eg1) When the numerical keys "1 _{ABC} " is pressed: once → "1" is displayed. twice → "A" is displayed. for 3 times → "B" is displayed. for 4 times → "C" is displayed. for 5 times → "a" is displayed. for 6 times → "b" is displayed. for 7 times → "c" is displayed. for 8 times → "1" is displayed. (Repeats.) Eg2) "SMC" → "S" is displayed when "7 _{STU} " is pressed twice. → Press "▷" to shift it to the right for one letter. → Press "5 _{MNO} " twice to display M. → Press "▷" to shift it to the right for one letter. → Press "1 _{ABC} " for four times to display "C". → Press "SET" to register.

1.2 Hardware specifications of the teaching box

(1)Hardware specifications

Item	Description
Applicable controller	LECP series,LECA series,LECPMJ series LECPA Series(Teaching Box of TB Ver. 2.1* or more) •Communication settings for controller Note1) Communication speed(bps): 38400 or 115200 Silent interval: x1 Communication delay time(ms): 5ms
Switch	Stop switch, enable switch (option)
Cable length	3 meters
Enclosure	IP64
Weight	350g (excluding the cable)
Operating temperature range	5 to 50 deg.C.
Operating humidity range	90%RH or less (no condensation)
Storage temp. range	-10 to 60 deg.C. (no condensation and freezing)
Storage humidity range	90%RH or less (no condensation)

Note1) Controller initial communication settings

Communication speed (bps): 38400

Silent interval: x1

Communication delay time (ms): 5ms

Teaching box is automatically recognize the communication speed.

2. How-to-Order

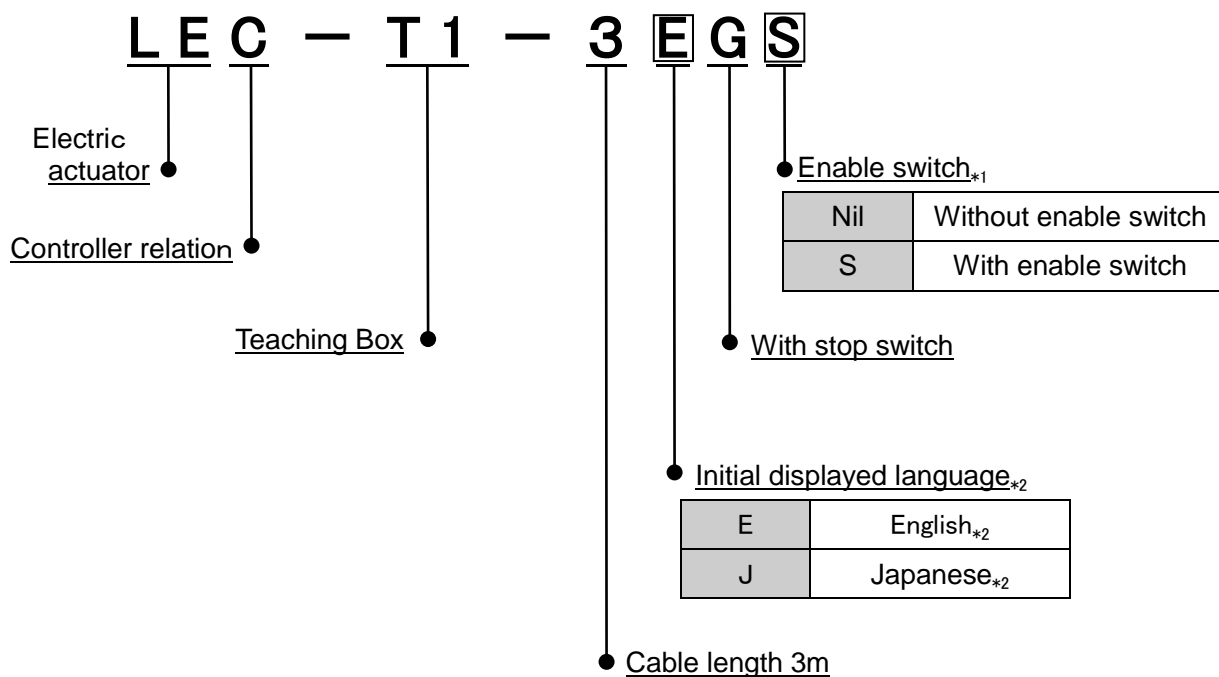

*1 When a teaching box with enable switch is selected, **it is necessary to activate the enable switch to change the default parameter setting of the controller.**

In the default setting, the enable switch is disabled for initial setting. Refer to "6.4 (3) Enable switch" for detail.

*2 Displayed language can be changed to "English" or "Japanese" by parameter settings of teaching box. Refer to "6.3 (9) Normal mode "TB setting" for details.

3. Functions

3.1 Easy mode

- This is the mode in which the minimum functions can be used. The functions can be selected with the icons. Setting of the minimum operation (step data), easy test drive and monitoring of the operation can be done.

(1) Functions in easy mode

*Some functions are different depending on teaching box version (TB Ver.). Refer to "5.1(1)" to confirm TB Ver.

Function	Description
Data	<ul style="list-style-type: none">▪ Setting of step data *TB Ver2.1* or more: When connecting to LECPA, the displayed step data is No.0 only.
Jog	<ul style="list-style-type: none">▪ JOG/MOVE operation and return to origin
Test	<ul style="list-style-type: none">▪ 1 step operation▪ Return to origin *When connecting to LECPA, the function "TEST" cannot be used. *TB Ver2.1* or more: When connecting to LECPA, the item "TEST" cannot be selected.
Monitor	<ul style="list-style-type: none">▪ Display of the step no.▪ Display of "position" and one more item (to be selected from position, speed, and force)
Alarm	<ul style="list-style-type: none">▪ Display of the active alarm▪ Alarm reset
Setting	<ul style="list-style-type: none">▪ TB Ver1.** : Reconnection of the axis.▪ TB Ver2.**: Display in English / Japanese.▪ Setting of easy mode/normal mode▪ Setting of the step data and selection of the item for the monitoring function.

(2)Tree structure of easy mode

* Some functions are different depending on teaching box version (TB Ver.). Refer to "5.1(1)" to confirm TB Ver.

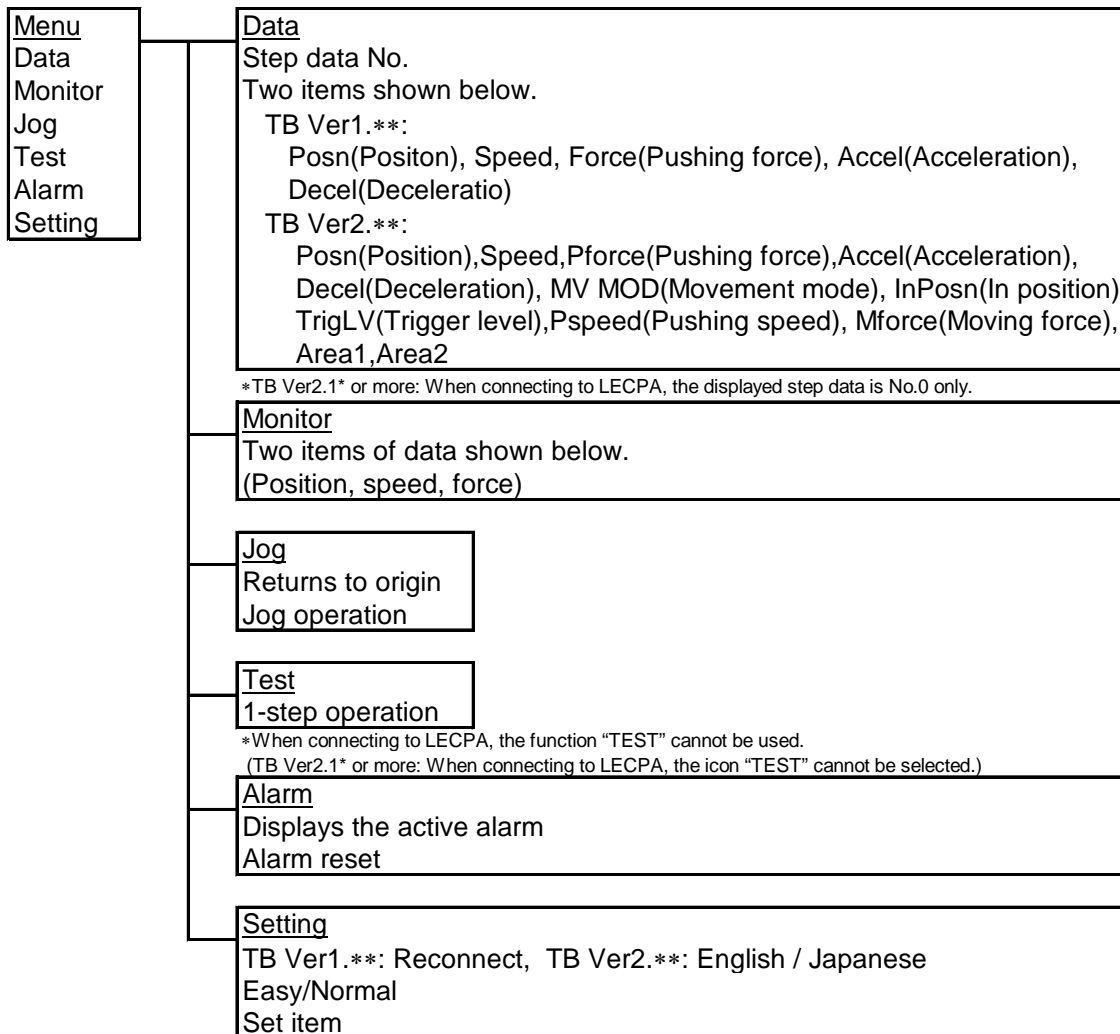

3.2 Normal mode

● This is the mode in which all the functions can be used. Functions can be selected from the list which is displayed. Detail setting of the operation (step data), setting of parameter, high level test drive and monitoring of the operation and input/output signal can be done.

(1) Functions in normal mode

*Some functions are different depending on teaching box version (TB Ver.). Refer to “5.1(1)” to confirm TB Ver.

Function	Description
Step data setting	<ul style="list-style-type: none"> Setting of the step data (positioning data) *TB Ver2.1* or more: When connecting to LECPA, the displayed step data is No.0 only.
Parameter setting	<ul style="list-style-type: none"> Setting of parameters
Test	<ul style="list-style-type: none"> Jog/Move Return to origin Test drive Specify five step data at maximum and operate. Output signal Output signal (It forces the pin ON/OFF according to the signal) Output pin (It forces the pin ON/OFF according to the pin number.) *When connecting to LECPA, the function “Test drive” cannot be used. *TB Ver2.1* or more: When connecting to LECPA, the item “Test drive” is not displayed in “Test “menu.
Monitor	<ul style="list-style-type: none"> Drive monitor Displays the status of position, speed, force, step no., last step no., Input pulse (When TB Ver2.1* or more teaching box is connected with LECPA). Output signal monitor TB Ver1.**: Displays the status of BUSY, SVRE, SETON, ALARM, INP, AREA, JOG-, JOG+, MODE and WREND. TB Ver2.**: Displays the output signals as shown previously with TB Ver1.** and now also the unit name and the version of the controller software. Input signal monitor Displays the status of SVON, DRV, SETUP, RST, JOG-, JOG+, FLGTH, MODE and WRST. Input/output pin monitor Displays the status of output pin and input pin.
Alarm	<ul style="list-style-type: none"> Active alarm display It can be reset if the alarm can be released. Alarm log record display
File	<ul style="list-style-type: none"> Data saving Saves the step data and parameter of the controller which is being used for communication. Load to controller Loads the data which is saved in the teaching box to the controller which is being used for communication. Delete the saved file Protect (Only TB Ver 2.**) Protects the saved file from overwriting, deletion and changing of the file name.

TB setting	<ul style="list-style-type: none">▪ Display setting (Easy mode/Normal mode)▪ Language setting (Japanese or English)▪ Backlight setting▪ LCD contrast setting▪ Beep sound setting▪ Max. ID number▪ Password
Reconnect	<ul style="list-style-type: none">▪ Reconnection of the axis

(2) Tree structure of easy mode

*Some functions are different depending on teaching box version (TB Ver.). Refer to “5.1 (1)” to confirm TB Ver.

*In the case of the “Parameter protect” set value in the basic parameter is “2”, the “Step data” is not displayed in the menu.

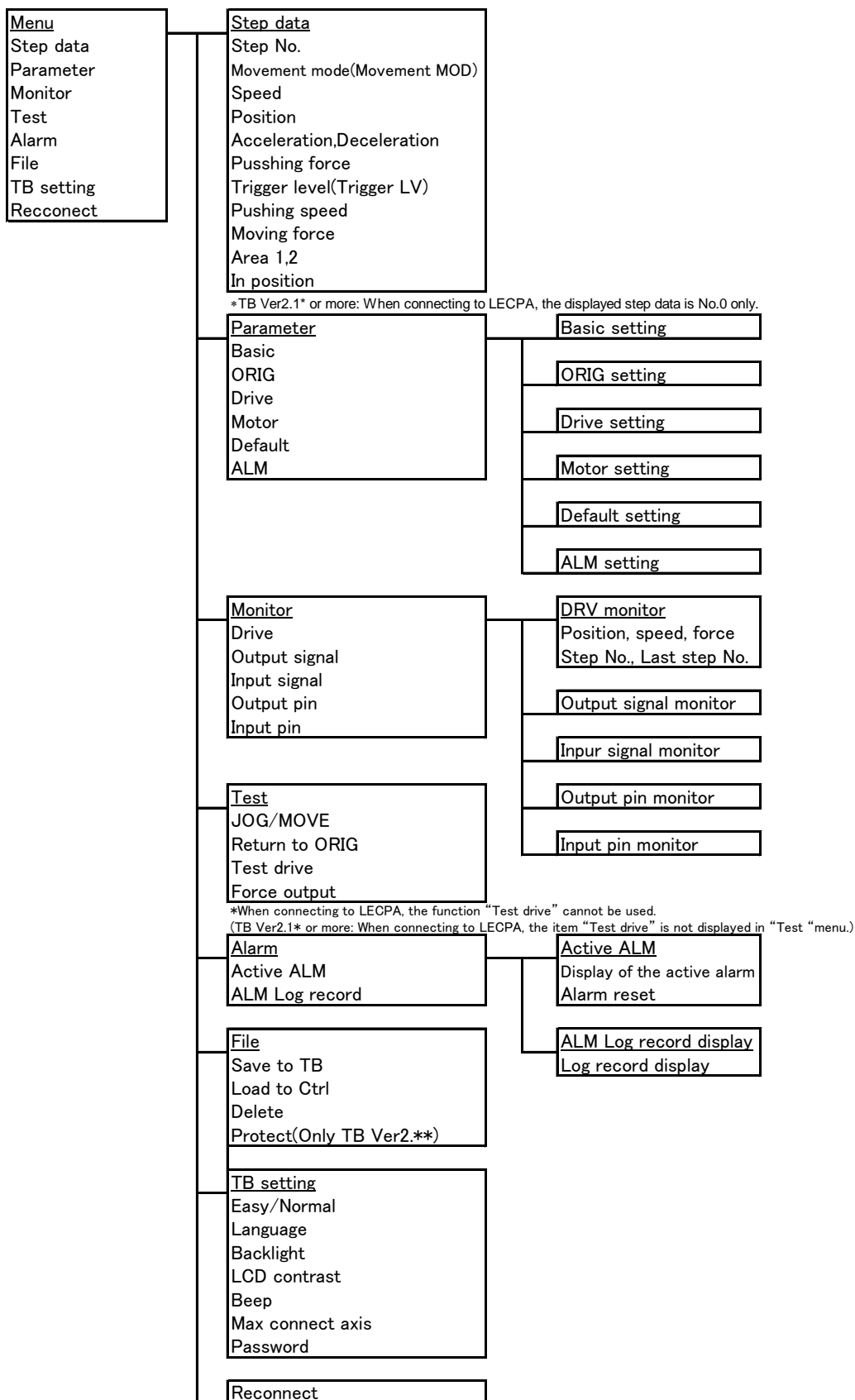

4. System Structure

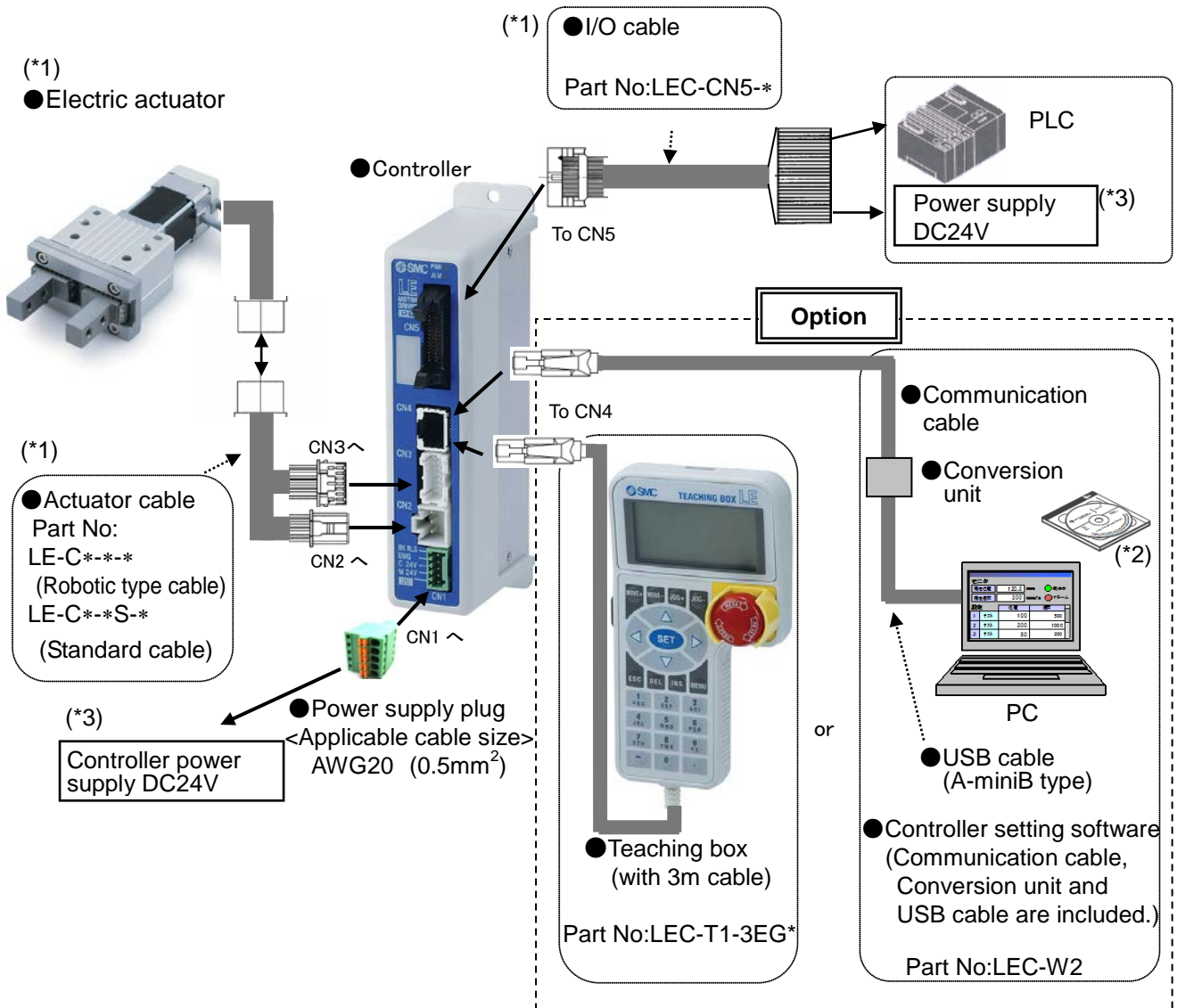

(*)1) These items are included when it is selected by ordering code.

(*)2) When the controller setting software/version is earlier than V1.2, please upgrade the controller setting software. Upgrade software be able to download on SMC website. <http://www.smcworld.com/>

(*)3) When conformity to UL is required, the electric actuator and controller should be used with a UL1310 Class 2 power supply.

Warning

Refer to "Operation manual of the controller" for wiring.
See 5 on p.32 for the caution of "Wiring of cables".

Communication cable is to be connected to the personal computer by USB cable through conversion unit.

Do not connect the teaching box directly to the personal computer.

Do not use LAN cable to connect to the controller, it will cause damage to the personal computer.

5. Procedures to Operation

* The procedure is shown below on the assumption that the electric actuator, applicable controller, switches and power supply are properly wired and connected.

Refer to the operation manual of the controller for how to connect of the above-mentioned equipment.

(1) Power supply to the controller



(2) Connect the teaching box to the applicable controller.

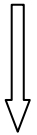

Connect the connector of the teaching box to the CN4 connector of the controller.

Refer to "5.1 Connection to teaching box"

(3) Change the display mode.

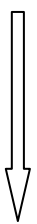

Select the display mode by setting with the teaching box. Refer to "5.2 Change of display mode".

The initial display mode is set to "Easy mode".

Easy mode: The minimum functions can be used. Select the function with the icon.

Normal mode: All the functions can be used. Select the function from the displayed list.

(4) Set the step data (positioning data).

*The step data for LECPA is the setting that concerns the operating.



Setting in easy mode: Refer to "5.3 (1) Setting example of step data in easy mode".

Setting in normal mode: Refer to "5.3 (2) Setting example of step data in normal mode".

(5) Check the operation.

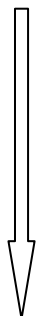

Operation check by test drive (When connecting to LECPA, "Test drive" cannot be used.)

In easy mode: Refer to "5.4.1 (1) Operation check by test drive in easy mode".

In normal mode: Refer to "5.4.1 (2) Operation check by test drive in normal mode".

Operation check by monitoring

In easy mode: Refer to "5.4.2 (1) Operation check with monitor in easy mode".

In normal mode: Refer to "5.4.2 (2) Operation check with monitor in normal mode".

(6) Drive the actuator.

Refer to the operation manual of the controller.

5.1 Connection to teaching box

* The procedure is shown below on the assumption that the electric actuator, applicable controller, switches and power supply are properly wired and connected.

Refer to the operation manual of the connectors for how to connect of the above mentioned equipment.

(1) Supply power to the controller and connect the teaching box to it.

The initial screen will be displayed and it confirms communication with the controller.

Wait for a few seconds until it shows the menu screen after the communication with the controller is confirmed.

*The version of the teaching box is displayed in the initial screen.

*Some functions are different depending on the teaching box version ("TB Ver", hereafter).

Image of the initial screen

```

SMC*****
Teaching Box
Hello!
*****Ver2.00
    
```

Menu screen in easy mode

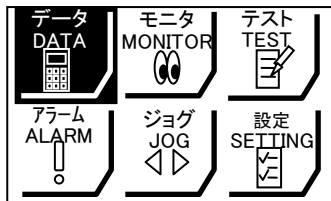

This screen will be displayed at the first power supply after shipping out of SMC factory.

Menu screen in normal mode

Menu	AX IS.	1
Step data		▲
Parameter		
Test		▼

5.2 Change of display mode

(1) How to change from easy mode to normal mode

① Select the function.

Press the “MENU” key to shift it to the menu screen.

Display the “SETTING” in the black highlight by pressing the “△▽ ◀▶” key.

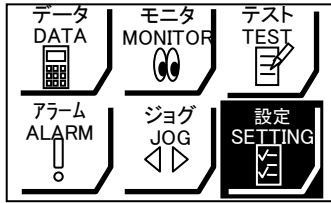

↓ Press the “SET” key.

② Select the display mode. (The screen depends on TB Ver. Refer to “5.1(1)” to confirm TB Ver.)

Display the choice of “Disp” in the black highlight by pressing the “△▽” key, and select “Normal” by pressing the “◀▶” key.

TB Ver1.**

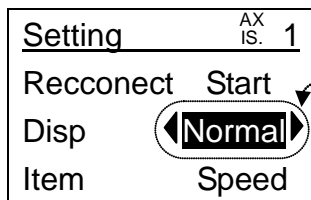

Select “Normal”
by pressing
the “◀▶” key.

↓ Press the “SET” key.

TB Ver2.**

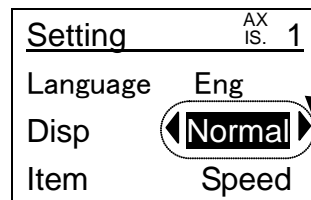

Select “Normal”
by pressing
the “◀▶” key.

③ Mode change completed.

The screen is changed to the initial screen, and then displays the menu in normal mode.

(2) How to change from normal mode to easy mode

① Select the TB setting function.

Press the “MENU” key to shift it to the menu screen.

Display the item “TB setting” in the black highlight by pressing the “△▽” key.

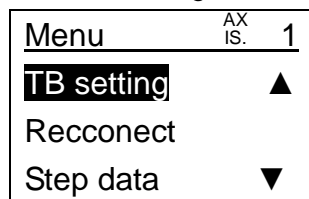

↓ Press the “SET” key.

② Select the display mode.

Select “Easy” by pressing the “◀▶” key.

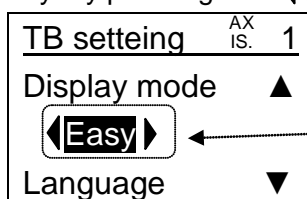

Select “EASY” by pressing the “◀▶” key, and press
“SET” key to determine.

↓ Press the “SET” key.

③ Mode change completed.

The screen is changed to the initial screen, and then displays the menu in easy mode.

5.3 Step data setting

The actuator system of using LECP or LECA is controlled by predefined step data stored in the controller. A step number in the form of digital code connected to the controller by external PLC can take charge of the actuator.

*The step data for LECSA is the setting that is not determined by pulse signal input such as positioning width.

External equipment

PLC, manual switch, etc.

Step data

When connecting to LECP or LECA:

Data which includes information such as “position”, “speed”, “acceleration” etc which are used for positioning of the actuator. One step data is needed for the positioning at one point.

When connecting to LECPA:

The step data for LECSA is the setting that is not determined by pulse signal input such as positioning width.

It can be set with the teaching box or the controller setup software.

When connecting to LECP or LECA, refer to “6.1 Step data” for detail of positioning and pushing operation.

(a) Positioning operation (When connecting to LECP or LECA)

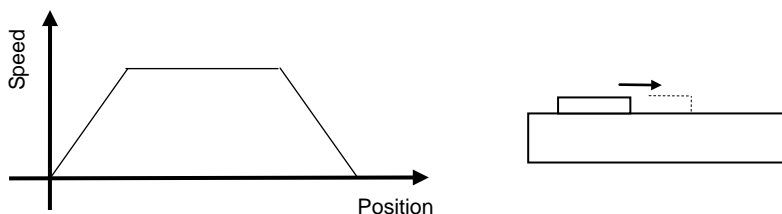

Operation, which moves to the specified position at the specified speed and acceleration.
(Example: Moving from the original position to 100mm from the original position by sliding actuator)

(b) Pushing operation (When connecting to LECP or LECA)

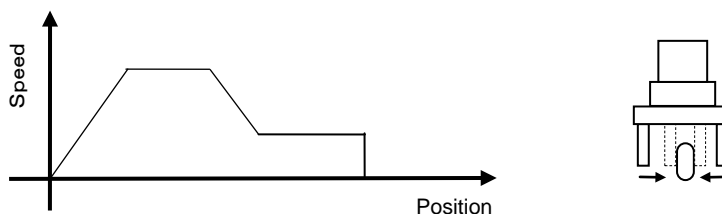

It makes positioning operation to the specified position, and moves for the specified distance at the specified speed after the positioning operation. If there is something such as workpiece during the operation, it keeps pushing with the specified force at maximum. (Ex: Holding a workpiece with a gripper.)

(1) Setting example of step data in easy mode

The items shown below of the step data can be set in easy mode "DATA".

The items of step data, which can be set, are different depending on the TB Ver. (Refer to "5.1(1)" to confirm TB Ver.)

TB Ver1.**:

"Posn (Position)", "Speed", "Force (Pushing force)", "Accel(Acceleration)" and "Decel(Deceleration)"

TB Ver2.**:

"Posn(Position)", "Speed", "Pforce (Pushing force)", "Accel(Acceleration)", "Decel(Deceleration)", "MV MOD(Movement mode)", "InPosn(In-position)", "TrigLV(Trigger level)", "Pspeed(Pusing speed)", "Mforce(Moving force)", "Area1" and "Area2"

TB Ver2.1 or more: When connecting to LECPA, "Pforce (Pushing force)", "InPosn(In-position)", "TrigLV(Trigger level)", "Pspeed(Pusing speed)", "Mforce(Moving force)", "Area1" and "Area2".

Only two items can be displayed and set in "Easy mode / DATA".

The displayed Items in "Easy mode / DATA" can be changed by changing the choice of "Easy mode / SETTING". Refer to "6.2 (3) ④ Change of the set item" for detail.

If the teaching box TB Ver1.** is used, "Movement mode", "Trigger level", "Pushing force", "In position" and "Area 1, 2" at easy mode. These items refer to the set values when the contents of the same step data No. are displayed with normal mode. They can be changed in normal mode "Step data".

Step data setting items in positioning operation (When connecting to LECP or LECA)

Force (Pushing Force : In normal mode) ⇒ Set "0".

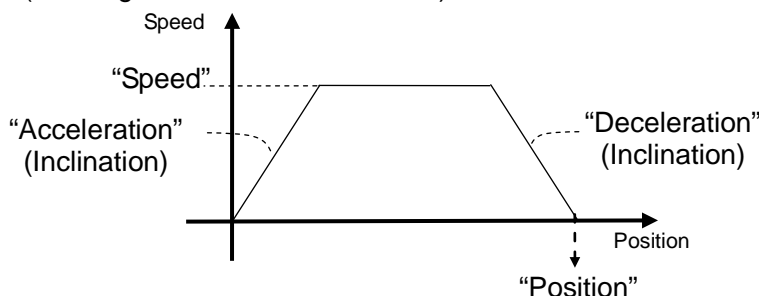

Step data setting items in pushing operation (When connecting to LECP or LECA)

Force (Pushing Force : In normal mode) ⇒ Set value more than minimum moving force of the actuator used.

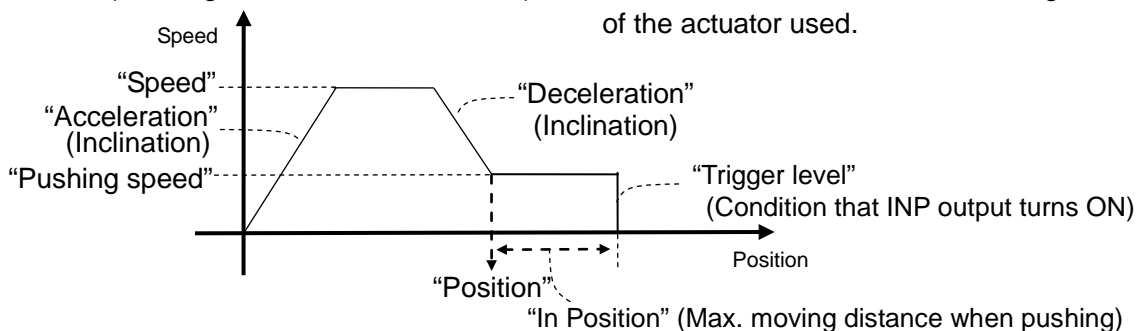

* Refer to "5.2 (2) How to change from normal mode to easy mode" for how to change from normal mode to easy mode.
 * Refer to "6.1 Step data" for the detail of the set items for step data.

(1-1) Setting example of positioning operation in easy mode (When connecting to LECP or LECA)

* The description below is given on the assumption that “0” (instruction for positioning) is set to the below item of the step data.

TB Ver1.**: “Force (In normal mode: Pushing force)”

TB Ver2.**: “Pforce(In normal mode: Push force)”

*Refer to "5.1(1)" to confirm TB Ver.).

- ① Display the “DATA” in the black highlight in the menu screen by pressing the “△▽◀▶” key, and press the “SET” key.

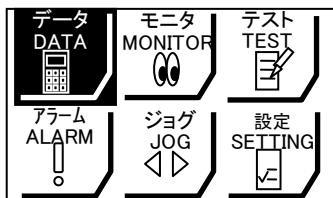

↓ Press the “SET” key.

- ② Press the number keys to input the step number to be set to “Step No.”, and press the “SET” key.

* The input vale will be cancelled off if “△▽” key is pressed before pressing the “SET” key.

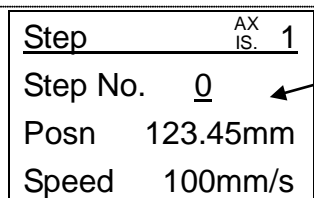

← Cursor (blinks)

} The set item will be changed depending on the kind of the actuator to be connected and “TB setting (default)”.

↓ Press the “▽” key.

- ③ Press number keys to input the target position for positioning in “Posn”, and press the “SET” key.

* TB Ver1.**:

To the movement mode of the step data which is set in easy mode, the “Movement MOD” of the same step number in normal mode is applied. The setting can be changed in “Normal mode / STEP DATA / Movement MOD”.

* TB Ver2.**:

All of the step data items can be set in easy mode. The item displayed in “DATA” function can be changed in “Easy mode / SETTING”.

*Default of “MV MOD(Movement mode)” is set as the following.

Step data No.0 & No.1: “Absolute (Origin standard)”

The other step data: ” Disable”

If the step data that ”MV MOD” is set as “Disable” is commanded to drive, The alarm “Step data error” occurs.

↓ Press the “▽” key.

- ④ Press the number keys to input the speed when positioning to “Speed”, and press the “SET” key. The input range will be varied depending on the actuator to be used.

↓

- ⑤ Complete. Return to the menu screen by pressing either the “MENU” key once or the “ESC” key twice.

* TB Ver1.**:

The example of the procedure shown above is for set items “Posn” and “Speed”. The set item can be changed to “Accel”, “Decel”, “Force (Pushing force)” depending on the set value in “Easy mode / SETTING” and “Normal mode / Parameter / Default”.

* TB Ver2.**:

The example of the procedure shown above is for set items “Posn” and “Speed”. The set item can be changed to “Accel”, “Decel”, “Pforce (Pushing force)”, “MV MOD(Movement mode)”, “InPosn(In-position)”, “TrigLV(Trigger level)”, “Pspeed(Pushing speed)”, “Mforce(Moving force)”, “Area1” and “Area2” depending on the set value in “Easy mode / SETTING” and “Normal mode / Parameter / Default”.

* Refer to “6.2 (3) ④ Change of the set item” for detail.

(2) Setting example of step data in normal mode

All items of the step data can be set in "Normal mode / Step data"

The setting operation is different depending on TB Ver. (Refer to “5.1(1)” to confirm TB Ver.)

All items of the step data:

“Accel(Acceleration)”, “Decel(Deceleration)”, “Pforce (Pushing force)”, “MV MOD(Movement mode)”, “InPosn(In position)”, “TrigLV(Trigger level)”, “Pspeed(Pusing speed)”, “Mforce(Moving force)”, “Area1” and “Area2”

* Refer to “5.2 (1) How to change from easy mode to normal mode” for how to change from easy mode to normal mode.

* Refer to “6.1 Step data” for detail of the step data set items.

*TB Ver2.1*or more: When connecting to LECPA, “Pforce (Pushing force)”, “InPosn(In-position)”, “TrigLV(Trigger level)”, “Pspeed(Pusing speed)”, “Mforce(Moving force)”, “Area1” and “Area2”.

(2-1) Setting example of step data in positioning operation (When connecting to LECP or LECA)

Step data setting items in positioning operation

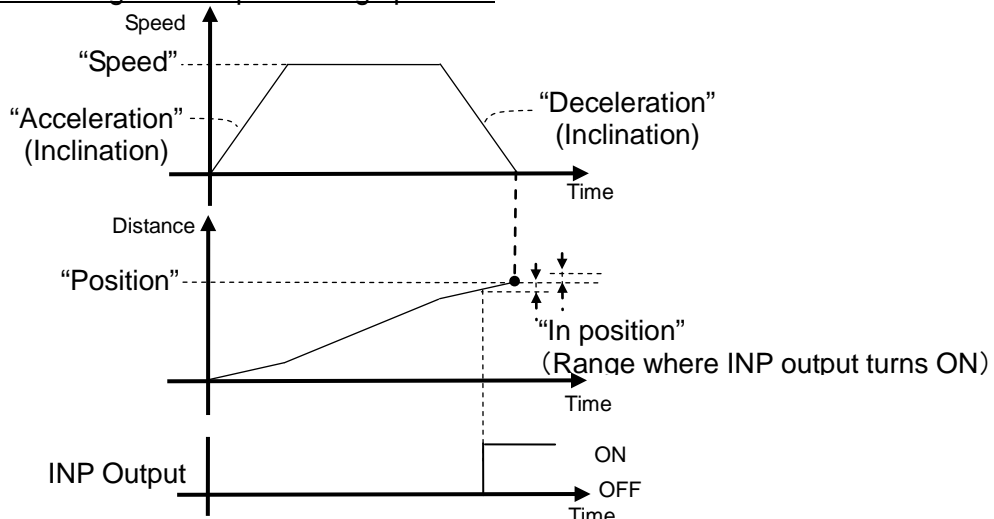

(2-1-a) TB Ver1.**

*Refer to "5.1(1)" to confirm TB Ver.

① Shift to the step data setting

Display the "Step data" in the black highlight in the menu screen by pressing the "△▽" key, and press the "SET" key.



The background color is black when the item is selected for setting.

↓ Press the "SET" key.

② Specify the step number to be set.

Show the "Step No." in the second line on the screen, and press the number keys of the step number to be set, and press the "SET" key.

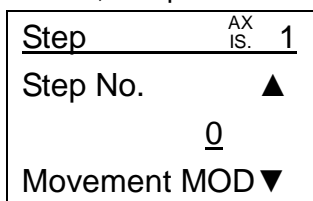

↓ Press the "▽" key.

③ Set "Movement MOD(Movement mode)".

Show "Movement MOD(Movement mode)" in the second line on the screen, and select the choice with "◀▶" key, and press the "SET" key to register.

Movement MOD(Movement mode)

When "Absolute" is selected : Target position is set on the absolute position with reference to the origin.
When "Relative" is selected : Target position is set on the relative position with reference to the current position.
When "Disable" is selected : The step data of the set step number is disabled.

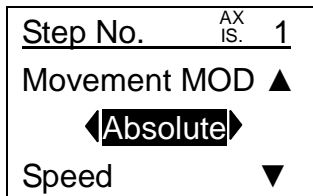

↓ Press the "▽" key.

④ Set "Speed".

Show "Speed" in the second line on the screen, and input the speed when positioning with the number keys, and press the "SET" key to register.

The input range will vary depending on the actuator used.

↓ Press the "▽" key.

⑤ Set "Position".

Show "Position" in the second line on the screen.

The position can be set by the preferable way of the three shown below.

- "Key pad entry" : Inputting of the position by the number keys.

⇒ Refer to "5.3 (2-3-1)"

- "JOG input" : Entering the stopping position, after the actuator is moved by JOG/MOVE.

⇒ Refer to "5.3 (2-3-2)"

- "Direct input" : Entering the stopping position, after the actuator has been moved manually.

⇒ Refer to "5.3 (2-3-3)"

↓ Press the "▽" key.

⑥ Set "Acceleration" and "Deceleration".

Show "Acceleration" in the second line on the screen, and enter the acceleration when positioning with the number keys, and press the "SET" key to register.

The input range will be dependent on the actuator used.

↓ Press the "▽" key.

Show "Deceleration" and enter it by following the above procedure.

↓ Press the "▽" key.

⑦ Set "Pushing force".

Show "Pushing force" in the second line on the screen, and enter "0".

The step data for which "Pushing force" is "0" is always used for positioning.

↓ Press the "▽" key for several times.

⑧ Complete.

Return to the menu screen by pressing either the "MENU" key once or the "ESC" key twice.

- * "Moving force" and "In-position" should not be changed from the default value.
- * Setting of "Area 1 and 2" is omitted in this description. Refer to "6.1 Step data" when setting.
- * "Trigger LV" and "Pushing speed" do not need to be set because they are disable.

(2-1-b) TB Ver2.**

*Refer to "5.1(1)" to confirm TB Ver.

① Shift to the step data setting

Display the "Step data" in the black highlight in the menu screen by pressing the "△▽" key, and press the "SET" key.

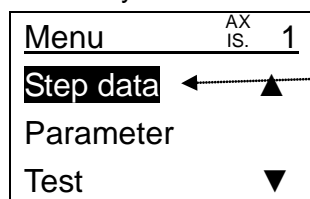

The background color is black when the item is selected for setting.

↓ Press the "SET" key.

②Set " Move mode (Movement mode)"

Show the "Move mode(Movement MOD)" in the second line on the screen by pressing the "◀▶" key.

Step	AX IS.	1
No.	◀ Move mode ▶	
000	Absolute	
001	Relative	

↓ Press the "SET" key.

(The setting of the item is selected in the 3rd or the 4th line on the screen)

Display the set content of "Move mode(Movement MOD)" of the step No. which is set in the black highlight by pressing the "△▽" key.

Select the choice with "◀▶" key, and press the "SET" key.

Move mode(Movement MOD)	
When "Absolute" is selected :	Target position is set on the absolute position with reference to the origin.
When "Relative" is selected :	Target position is set on the relative position with reference to the current position.
When "Disable" is selected :	The step data of the set step number is disabled.

Step	AX IS.	1
No.	Move mode	
000	◀ Absolute ▶	
001	Relative	

↓ Press the "ESC" key. It returns to the second line (the item) on the screen.

③Set "Speed"

Show the "Speed" in the second line on the screen by pressing "◀▶" key.

↓ Press the "SET" key.

(The setting is selected in the 3rd or 4th line on the screen.)

Select the set value of "Speed" of the step No. which is set by pressing "△▽" key, and enter the speed when positioning with the number keys, and press the "SET" key to register.

The input range will be different depending on the actuator used.

↓ Press the "ESC" key. It returns to the second line (the item) on the screen.

④Set "Position"

Show the "Position" in the second line on the screen by pressing "◀▶" key.

↓ Press the "SET" key.

(The set value is selected in the 3rd or 4th line on the screen.)

Display the set value of "Position" of the step No. which is set in the black highlight by pressing the "△▽" key.

The position can be set by the preferable way of the three shown below. It is selected by pressing "◀▶" key.

● "Key pad entry" : Inputting of the position by the number keys.

⇒ Refer to "5.3 (2-3-1)"

● "JOG input" : Entering the stopping position, after the actuator is moved by JOG/MOVE.

⇒ Refer to "5.3 (2-3-2)"

● "Direct input" : Entering the stopping position, after the actuator has been moved manually.

⇒ Refer to "5.3 (2-3-3)"

↓ Press the "ESC" key. It returns to the second line (the item) on the screen.

⑤ Set "Accelerate(Acceleration)" and "Decelerate(Deceleration)"

Show the "Accelerate(Acceleration)" in the second line on the screen by pressing "◀▶" key.

↓ Press the "SET" key.

(The setting is selected in the 3rd or 4th line on the screen.)

Select the set value of "Accelerate(Acceleration)" of the step No. which is set by pressing "△▽" key, and enter the Acceleration when positioning with the number keys, and press the "SET" key to register.

The input range will be different depending on the actuator used.

↓ Press the "ESC" key. It returns to the second line (the item) on the screen

Show "Deceleration(Decelerate)" and enter it.

The setting procedure is same as "Acceleration (Accelerate)" shown above

↓ Press the "ESC" key. It returns to the second line (the item) on the screen

⑥ Set "Pushing force(Push force)"

Show the "Pushing force(Push force)" in the second line on the screen by pressing "◀▶" key.

↓ Press the "SET" key.

(The setting is selected in the 3rd or 4th line on the screen.)

Select the set value of "Pushing force(Push force)" of the step No. which is set by pressing "△▽" key, and enter "0" with the number keys, and press the "SET" key to register.

The step data for which "Pushing force(Push force)" is "0" is always used for positioning.

↓ Press the "ESC" key. It returns to the second line (the item) on the screen

⑦ Complete.

Return to the menu screen by pressing either the "MENU" key once or the "ESC" key three times.

- * "Moving force(Move force)" and "InPosition" should not be changed from the default value.
- * Setting of "Area 1 and 2" is omitted in this description. Refer to "6.1 Step data" when setting.
- * "Trigger LV" and "Pushing speed(Pspeed)" do not need to be set because they are disable.

(2-2) Example of Setting step data in pushing operation(When connecting to LECP or LECA)

Step data setting items in pushing operation

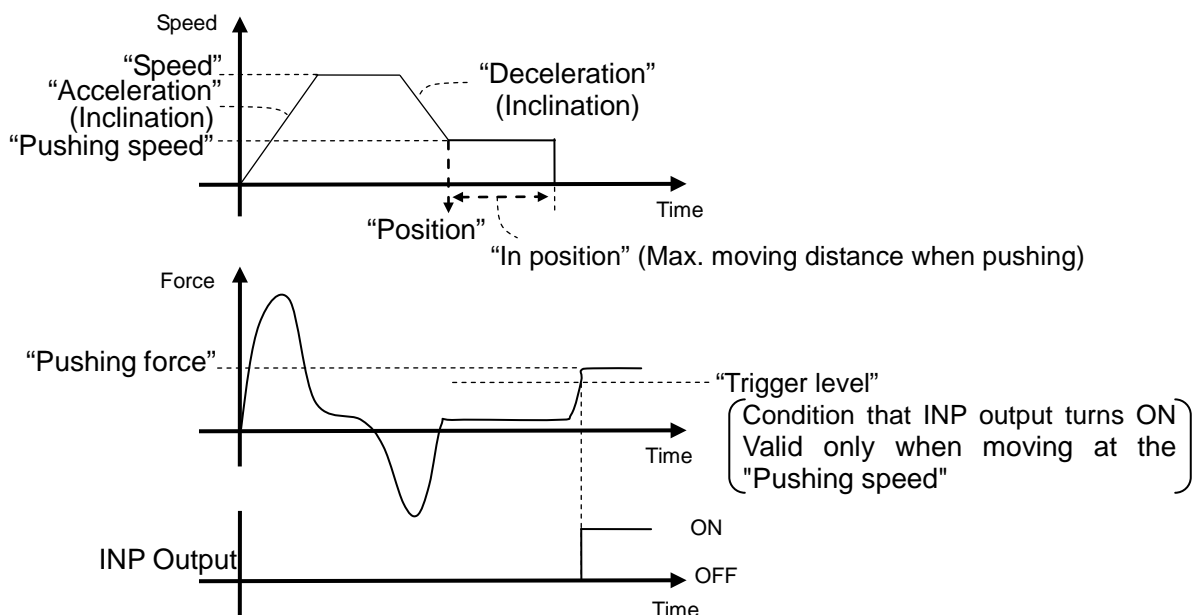

(2-2-a) TB Ver1.**

*Refer to "5.1(1)" to confirm TB Ver.

① Shift to the step data setting

Display the "Step data" in the black highlight in the menu screen by pressing the "Δ▽" key, and press the "SET" key.

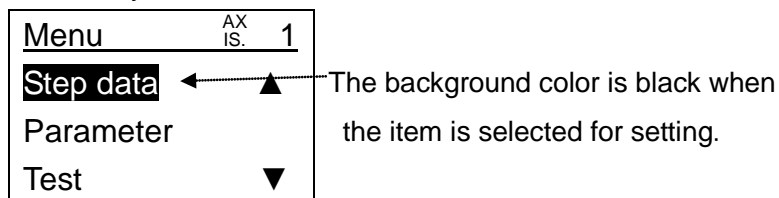

↓ Press the "SET" key.

② Specify the step number to be set.

Show the "Step No." in the second line on the screen, and press the number keys of the step number to be set, and press the "SET" key.

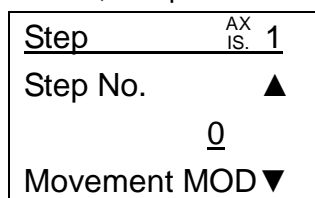

↓ Press the "▽" key.

③ Set "Movement MOD(Movement mode)".

Show "Movement MOD(Movement mode)" in the second line on the screen, and select the choice with "◀ ▶" key and press the "SET" key to register.

Movement MOD(Movement mode)	
When "Absolute" is selected	: Target position is set on the absolute position with reference to the origin.
When "Relative" is selected	: Target position is set on the relative position with reference to the current position.
When "Disable" is selected	: The step data of the set step number is disable

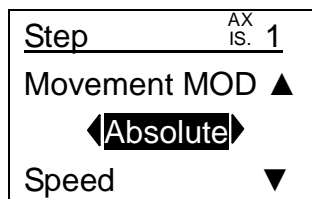

↓ Press the "▽" key.

④ Set "Speed".

Show "Speed" in the second line on the screen, and input the speed when positioning with the number keys, and press the "SET" key to register.

The input range will be different depending on the actuator to be used.

↓ Press the "▽" key.

⑤ Set "Position".

Show "Position" in the second line on the screen.

The position can be set by the preferable way of the three shown below.

- "Key pad entry" : Entering of the position by the number keys.
⇒ Refer to "5.3 (2-3-1)"
- "JOG input" : Entering the stopping position, after the actuator is moved by JOG/MOVE.
⇒ Refer to "5.3 (2-3-2)"
- "Direct input" : Entering the stopping position, after the actuator has been moved manually.
⇒ Refer to "5.3 (2-3-3)"

↓ Press the "▽" key.

⑥ Set "Acceleration" and "Deceleration".

Show "Acceleration" in the second line on the screen, and enter the acceleration when positioning with the number keys, and press the "SET" key to register.

The input range will be different depending on the actuator to be used.

↓ Press the "▽" key.

Show "Deceleration" and enter it.

The setting procedure is same as "Acceleration" shown above.

↓ Press the "▽" key.

⑦ Set "Pushing force"

Show "Pushing force" in the second line on the screen, and set the value within the range in specification of actuator used, and press the "SET" key to register.

The step data which "Pushing force" is "1" or more makes it a pushing operation.

↓ Press the "▽" key.

⑧ Set "Trigger LV(Trigger level)"

INP output is turned ON when the force exceeds the value which is set as "Trigger LV (Trigger level)" during the actuator is moving from "Position" at "Pushing speed".

Show "Trigger LV" in the second line on the screen, and press number keys to make it as "Pushing force \geq Trigger LV(Trigger level)", and press the "SET" key to register.

The step data which is set under out of the above mentioned conditions generates an alarm of "abnormal step data" when an operation is instructed.

↓ Press the "▽" key.

⑨ Set "Pushing speed"

Set the speed when pushing.

Set the value within the range between the lowest speed of the actuator used and 20mm/s, and press "SET" key to register..

↓ Press the "▽" key for three times.

⑩ Set "In position"

When "Pushing force" of the step data is set to "1" or more and a pushing operation is set, "In position" is the setting of the maximum moving distance for pushing.

Show "In position" in the second line on the screen, and set the maximum moving distance for using the number keys, and press the "SET" key to register.

↓ Press the "▽" key.

⑪ Complete.

Return to the menu screen by pressing either the "MENU" key once or the "ESC" key twice.

- * "Moving force" should not be changed from the default value.
- * Setting of "Area 1 and 2" is omitted in this description. Refer to "6.1 Step data" when setting.
- * "Trigger LV(Trigger level)" and "Pushing speed" do not need to be set because they are invalid when "Pushing force" is set to 1 or more.

(2-2-b) TB ver2.**

* Refer to "5.1(1)" to confirm TB Ver.

① Shift to the step data setting

Display the "Step data" in the black highlight in the menu screen by pressing the "△▽" key, and press the "SET" key.

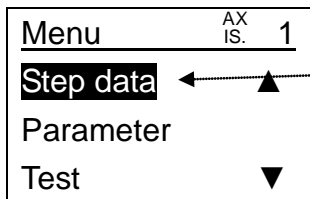

The background color is black when the item is selected for setting.

↓ Press the "SET" key.

② Set " Move mode(Movement MOD)"

Show "Move mode (Movement MOD)" in the second line on the screen, and select the choice with "◀▶" key

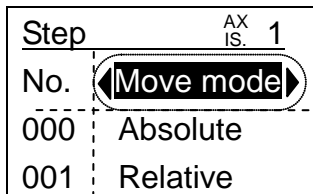

↓ Press the "SET" key.

(The set value is selected in the 3rd or 4th line on the screen.)

Display the setting content of "Move mode(Movement MOD)" of the step No. which is set in the black highlight by pressing the "△▽" key. Select the choice with "◀▶" key, and press the "SET" key to register.

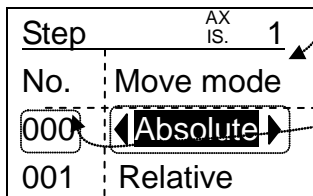
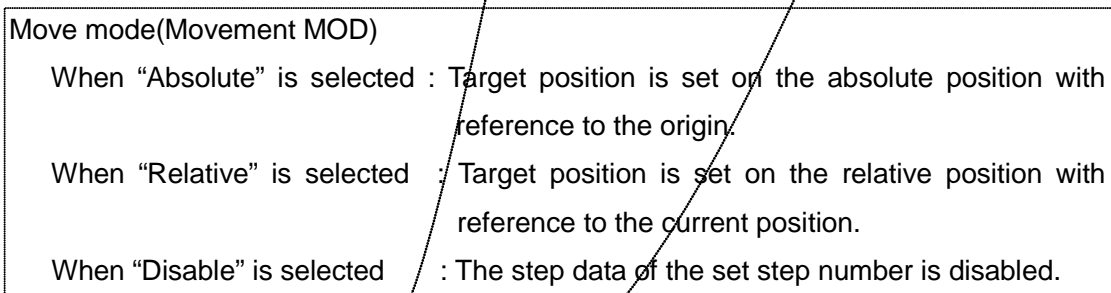

↓ Press the "ESC" key. It returns to the second line (the item) on the screen.

③ Set "Speed"

Show the "Speed" in the second line on the screen by pressing "◀▶" key.

↓ Press the "SET" key.

(The setting is selected in the 3rd or 4th line on the screen.)

Select the set value of "Speed" of the step No. which is set by pressing "△▽" key, and enter the speed when positioning with the number keys, and press the "SET" key to register.

The input range will be different depending on the actuator used.

↓ Press the "ESC" key. It returns to the second line (the item) on the screen.

④Set "Position"

Show the "Position" in the second line on the screen by pressing "◀▶" key.

↓ Press the "SET" key.

(The setting is selected in the 3rd or 4th line on the screen.)

Display the set value of "Position" of the step No. which is set in the black highlight by pressing the "△▽" key.

The position can be set by the preferable way of the three shown below. It is selected by pressing "◀▶" key.

● "Key pad entry" : Inputting of the position by the number keys.

⇒ Refer to "5.3 (2-3-1)"

● "JOG input" : Entering the stopping position, after the actuator is moved by JOG/MOVE.

⇒ Refer to "5.3 (2-3-2)"

● "Direct input" : Entering the stopping position, after the actuator has been moved manually.

⇒ Refer to "5.3 (2-3-3)"

↓ Press the "ESC" key. It returns to the second line (the item) on the screen.

⑤Set "Accelerate (Acceleration)" and "Decelerate(Deceleration)"

Show the "Accelerate(Acceleration)" in the second line on the screen by pressing "◀▶" key.

↓ Press the "SET" key.

(The setting is selected in the 3rd or 4th line on the screen.)

Select the set value of "Accelerate(Acceleration)" of the step No. which is set by pressing "△▽" key, and enter the Acceleration when positioning with the number keys, and press the "SET" key to register.

The input range will be different depending on the actuator used.

↓ Press the "ESC" key. It returns to the second line (the item) on the screen

Show "Decelerate(Decelerate)" and enter it.

The setting procedure is same as "Acceleration (Accelerate)" shown above.

↓ Press the "ESC" key. It returns to the second line (the item) on the screen

⑥Set "Push force(Pushing force)"

Show the "Push force(Pushing force)" in the second line on the screen by pressing "◀▶" key.

↓ Press the "SET" key.

(The setting is selected in the 3rd or 4th line on the screen.)

Select the set value of "Push force(Pushing force)" of the step No. which is set by pressing "△▽" key, and set the value within the range in specification of actuator used with the number keys, and press the "SET" key to register.

The step data which "Push force (Pushing force)" is "1" or more makes it a pushing operation.

↓ Press the "ESC" key. It returns to the second line (the item) on the screen

⑦Set "Trigger LV(Trigger level)"

INP output is turned ON when the force exceeds the value which is set as "Trigger LV (Trigger level)" during the actuator is moving from "Position" at "Pushing speed".

Show "Trigger LV(Trigger level)" in the second line on the screen by pressing " $\triangleleft \triangleright$ " key.

↓ Press the "SET" key.

(The setting is selected in the 3rd or 4th line on the screen.)

Select the set value of "Trigger LV(Trigger level)" of the step No. which is set by pressing " $\triangle \nabla$ " key, and press number keys to make it as "Push force(Pushing force) \geq Trigger LV(Trigger level)", and press the "SET" key to register.

The step data which is set under out of the above mentioned conditions generates an alarm of "abnormal step data" when an operation is instructed.

↓ Press the "ESC" key. It returns to the second line (the item) on the screen

⑧Set "Push speed(Pushing speed)"

Show "Push speed(Pushing speed)" in the second line on the screen by pressing " $\triangleleft \triangleright$ " key.

↓ Press the "SET" key.

(The setting is selected in the 3rd or 4th line on the screen.)

Select the set value of "Push speed(Pushing speed)" of the step No. which is set by pressing " $\triangle \nabla$ " key, and set the value within the range between the lowest speed of the actuator used and 20mm/s with the number keys, and press the "SET" key to register.

↓ Press the "ESC" key. It returns to the second line (the item) on the screen

⑨Set "InPosition"

When "Push force(Pushing force)" of the step data is set to "1" or more and a pushing operation is set, "InPosition" is the setting of the maximum moving distance for pushing.

Show "InPosition" in the second line on the screen by pressing " $\triangleleft \triangleright$ " key.

↓ Press the "SET" key.

(The setting is selected in the 3rd or 4th line on the screen.)

Select the set value of "InPosition" of the step No. which is set by pressing " $\triangle \nabla$ " key, and set the maximum moving distance for pushing by using the number keys, and press the "SET" key to register.

↓

⑩Complete.

Return to the menu screen by pressing either the "MENU" key once or the "ESC" key three times.

- * "Move force(Moving force)" should not be changed from the default value.
- * Setting of "Area 1 and 2" is omitted in this description. Refer to "6.1 Step data" when setting.
- * "Trigger LV(Trigger level)" and "Push speed(Pushing speed)" do not need to be set because they are invalid when "Push force(Pushing force)" is set to 1 or more.

(2-3) Details of “Position” setting (When connecting to LECP or LECA)

* Refer to “5.1(1)” to confirm TB Ver.

Show “Position” which is the step data setting item on the second line on the screen

Cursor is shown under the numerical value.

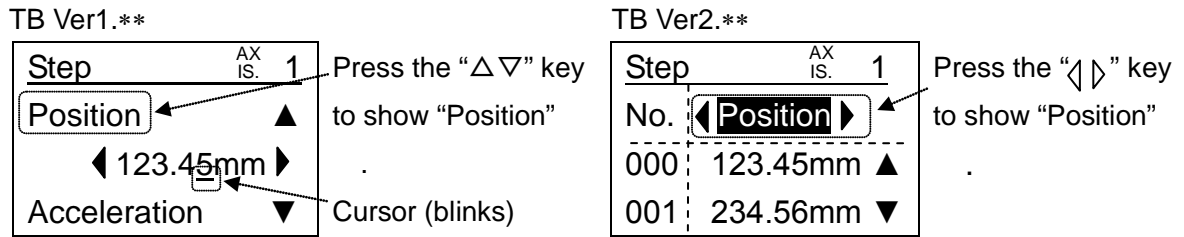

(2-3-1) Number input (When connecting to LECP or LECA)

* Refer to “5.1(1)” to confirm TB Ver.

① Enter the numerical value for position with number keys, and press the “SET” key to register.

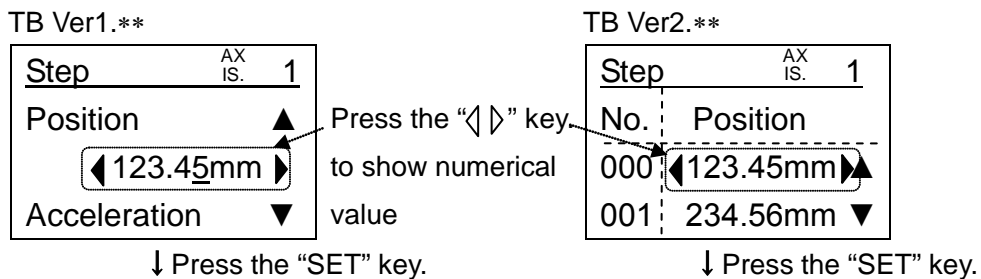

② Registration of position completed.

(2-3-2) JOG input (When connecting to LECP or LECA)

* Refer to “5.1(1)” to confirm TB Ver.

① Selection of “Jog input”.

Select the choice to “Jog input” with the “◀▶” key, and press the “SET” key.

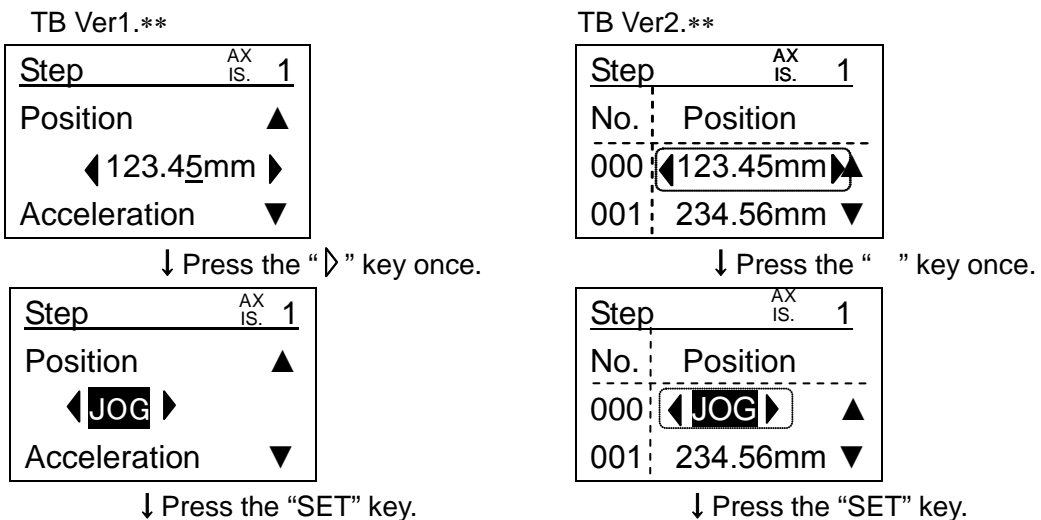

② EXT Inp OFF: To confirm whether to disable the input from external equipment such as PLC. It is necessary to be disable the input from outside to do “JOG input” operation.

↓ Select “YES” and press the “SET” key.

③ Servo ON, Ready?: To confirm whether to turn the servo ON only when the motor power is OFF.

↓ Select "YES" and press the "SET" key.

④ Return to origin?: To confirm whether to return to origin. If previously not referenced.

↓ Select "YES" and press the "SET" key.

⑤ JOG speed setting

Input the jog speed with the number keys, and press the "SET" key.

Posn(JOG)	^{AX} IS.	1
Speed		
		100mm/s
Move distance		▼

↓ Press the "▽" key.

⑥ MOVE distance setting

Input the distance for moving with the number keys, and press the "SET" key.

Posn(JOG)	^{AX} IS.	1
Move distance		▲
		5.00mm
JOG/MOVE		▼

↓ Press the "SET" key.

⑦ Registration of position (JOG, MOVE)

"JOG+", "JOG-", "MOVE+" and "MOVE-" keys are valid. Operate the actuator to the preferable position with these keys and determine the position, and register it by pressing the "SET" key.

Posn(JOG)	^{AX} IS.	1
JOG/MOVE		
Posn		12.34mm
"SET":Save Posn		

↓ Press the "SET" key.

⑧ EXT Inp ON: To confirm whether to be enable the input from external equipment such as PLC.

⚠ Warning
Confirm safety when recovering of input before pressing the SET key to determine "OK". The actuator may operate suddenly when the input from outside equipment such as PLC is recovered.

↓ Press the "SET" key after confirming safety.

⑨ Completion of position registration

The position will be registered to the step data of the specified number by pressing the "SET" key.
It will automatically shift to the setup screen of step data.

(2-3-3) Direct input (When connecting to LECP or LECA)

*Refer to "5.1(1)" to confirm TB Ver.

- ① Select "Direct input".

Select "Direct input" with the "◀▶" key, and press the "SET" key.

TB Ver1.**

Step	AX IS. 1
Position	▲
◀123.45mm▶	
Acceleration	▼

↓ Press the "▶" key once.

Step	AX IS. 1
Position	▲
◀Direct▶	
Acceleration	▼

↓ Press the "SET" key.

TB Ver2.**

Step	AX IS. 1
No. Position	
000	◀123.45mm▶
001	234.56mm ▼

↓ Press the "▶" key once.

Step	AX IS. 1
No. Position	
000	◀Direct▶ ▲
001	234.56mm ▼

↓ Press the "SET" key.

- ② EXT Inp OFF: To confirm whether to disable the input from outside equipment such as PLC. It is necessary to be disable the input from outside to do "JOG input" operation.

↓ Select "YES" and press the "SET" key.

- ③ Servo ON, Ready?: To confirm whether to turn the servo ON only when the motor power is OFF.

↓ Select "YES" and press the "SET" key.

- ④ Return to origin?: To confirm whether to return to origin. If previously not referenced.

↓ Select "YES" and press the "SET" key.

- ⑤ Servo OFF

Select "Servo OFF" in "Status", and press the "SET" key.

↓ Press the "SET" key.

- ⑥ Execute?: To confirm whether to turn the motor power OFF (servo OFF).

After confirming safety, select "YES", and press the "SET" key to execute.

⚠ Warning
Actuators with brake: It maintains the brake even if the servo OFF is executed, and it will not accept direct input. Confirm safety and release the brake with the "BK RLS" terminal of the controller CN1 to execute the direct input.

Check	AX IS. 1
Execute?	
Yes No	

↓ Select "YES" and press the "SET" key.

⑦ Select the "Position".

Display the data of "Posn" in the black highlight by pressing the "△▽" key.

* It displays the current position in synchronization with the moving part of the actuator only when "Posn" is selected (with black highlight).

Posn(JOG)	^{AX} IS. 1
Status	ServoOFF
Posn	23.45 mm
"SET":Save Posn	



⑧ Resister the position.

Move the moving part of the actuator such as table by hand to determine the position.

↓ Press the "SET" key.

⑨ EXT Inp ON: To confirm whether to be enable the input from external equipment such as PLC.

 Warning
Confirm safety when recovering of input before pressing the SET key to determine "OK". The actuator may operate suddenly when the input from outside external equipment such as PLC is recovered.

↓ Press the "SET" key after confirming safety.

⑩ Completion of position registration

The position will be registered to the step data of the specified number by pressing the "SET" key.

It will automatically shift to the setup screen of step data.

5.4 Operation Check

Either of the two methods can be used for checking the operation.

(1) Operation check by test drive (When connecting to LECPA, test drive cannot be used.)

It makes test drive to check if it is positioned to the arbitrary position.

(Refer to “5.4.1 Operation check by test drive”.)

(2) Operation check with the monitor

Operation instruction with the manual switch or outside equipment such as PLC checks if it is positioned to the arbitrary positions with the monitor of the teaching box.

(Refer to “5.4.2 Operation check by monitor”.)

* Refer to the operation manual of the applicable controller for how to instruct the operation from the manual switch or outside equipment such as PLC.

* Refer to the following for how to change the modes, easy mode and normal mode:

In easy mode: Refer to “5.2(1) How to change from easy mode to normal mode”.

In normal mode: Refer to “5.2(2) How to change from normal mode to easy mode”.

5.4.1 Operation check by test drive

(1) Operation check by test drive in easy mode

*When connecting to LECPA, the function “TEST” cannot be used.

TB Ver2.1 or more: When connecting to LECPA, the icon “TEST” cannot be selected.

① Select the test function

Press the “MENU” key to shift to the menu screen.

Display the “TEST” in the black highlight in the menu screen by pressing the “ $\Delta \nabla \triangleleft \triangleright$ ” key, and press the “SET” key.

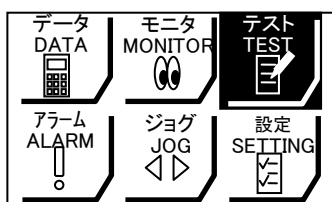

↓ Press the “SET” key.

② EXT Inp OFF: To confirm whether to disable the input from external equipment such as PLC. It is necessary to be disable the input from outside to do “JOG input” operation.

↓ Select “YES” and press the “SET” key.

③ Servo ON, Ready?: To confirm whether to turn the servo ON only when the motor power is OFF.

↓ Select “YES” and press the “SET” key.

④ Return to origin?: To confirm whether to return to origin. If previously not referenced.

↓ Select “YES” and press the “SET” key.

⑤ Specify the step number.

Input the step number to be tested to "Step No." with the number keys, and press the "SET" key.

Test	AX IS. 1
Step No.	20
Test	Start
Posn	123.45mm

↓ Press the "▽" key.

⑥ Start test drive.

Select "Start" in the line of "Test", and press the "SET" key.

It turns from "Start" to "Stop" after starting operation of the actuator, and it compulsorily stops operation when the "SET" key is pressed while it displays "Stop".

It is changed from "Stop" to "Complete" when the test drive is completed.

Test	AX IS. 1
Step No.	20
Test	Start
Posn	123.45mm

↓ After operation is completed.

⑦ Operation check

Check if it has moved to the programmed position while checking the displayed position and the actual position of the moving part.

↓ Without problem

⑧ Test completed.

Press the "MENU" key or press the "ESC" key twice to return to the menu screen.

(2) Operation check by test drive in normal mode

*When connecting to LECPA, the function "Test drive" cannot be used.

TB Ver2.1 or more: When connecting to LECPA, the item "Test drive" is not displayed in "Test" menu.

① Select the test function

Press the "MENU" key to shift to the menu screen.

Display the item "Test" in the black highlight in the menu screen by pressing the "Δ▽" key, and press the "SET" key.

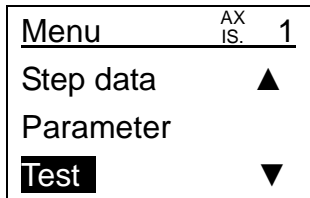

↓ Press "SET" key.

Display the item "Test drive" in the black highlight in the test screen by pressing the "Δ▽" key, and press the "SET" key.

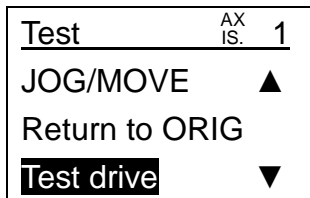

↓ Press the "SET" key.

② EXT Inp OFF: To confirm whether to disable the input from outside equipment such as PLC. It is necessary to be disable the input from outside to do "Test drive" operation.

↓ Select "YES" and press the "SET" key.

③ Servo ON, Ready?: To confirm whether to turn the servo ON only when the motor power is OFF.

↓ Select "YES" and press the "SET" key.

④ Return to origin?: To confirm whether to return to origin. If previously not referenced.

↓ Select "YES" and press the "SET" key.

⑤ Set the safety speed "Enable" / "Disable".

Select "Enable" or "Disable" for "Safety speed", and press the "SET" key.

Safety speed

When "Enable": When the set step data speed is faster than the "safety speed limitation (operation parameter)", it makes test drive with the speed limited to the "Safety speed limitation" as maximum.

When "Disable": It makes test drive with the set step data speed.

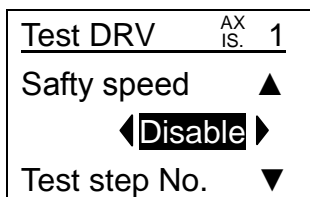

↓ Press the "▽" key.

- ⑥ Specify the step number to be used for the test drive.

Press the “◀▶” key to change the choice "None" to numerical value.

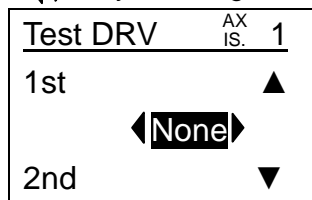

Select the first test step number.

Input the step number to be used for the test drive with number keys, and press the “SET” key.

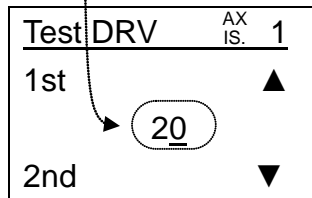

↓ Press the “▽” key for five times.

- ⑦ Set the number of cycles.

It will be recognized as one cycle with the continuous operation of the step data from first data to the fifth data. Set it either completing with one cycle or have continuous cycles.

Set it to complete with one cycle, and select “1”, then press the “SET” key.

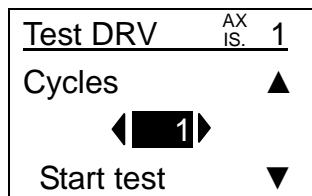

↓ Press the “▽” key.

- ⑧ Start test drive.

Display the item “Start test” in the black highlight by pressing the “△▽” key, and press the “SET” key to start test drive.

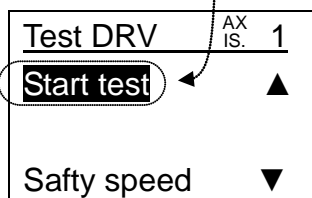

↓ Press the "SET" key and test drive is started.

- ⑨ Operation check

Check if it is moved to the preferable position while checking the displayed position and the actual position of the moving part.

It will be compulsorily stopped by pressing the “SET” key when the background color of “STOP” is turned to black.

It will be changed from “Stop” to “Complete” when the test operation is completed.

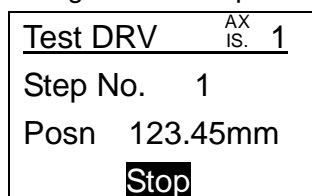

↓ When no problem is found, press the “SET” key after operation is completed.

- ⑩ Test completed.

Press the “MENU” key or press the “ESC” key for several times to return to the menu screen.

5.4.2 Operation check with monitor

(1) Operation check with monitor in easy mode

- ① Select the MONITOR function.

Press the “MENU” key to shift to the menu screen.

Display the “MONITOR” in the black highlight in the menu screen by pressing the “ Δ ∇ \rightarrow \leftarrow ” key, and press the “SET” key.

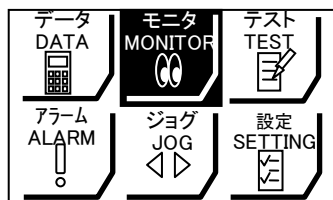

↓ Press the “SET” key.

- ② Specify the step number to be set by outside equipment.

Instruct the input of “IN*” of the controller by turning ON/OFF the manual switch or the outside equipment such as PLC.

(Refer to the operation manual of the connected controller.)

↓

- ③ Start driving by instruction from the outside equipment.

Turn the input “DRIVE” ON of the controller by a manual switch or outside equipment such as PLC and turn it off after positioning is completed.

(Refer to the operation manual of the connected controller.)

↓

- ④ Check operation.

Confirm if it is moved to the specified position by looking at the displayed position on the monitor screen and the actual position that the actuator moved to.

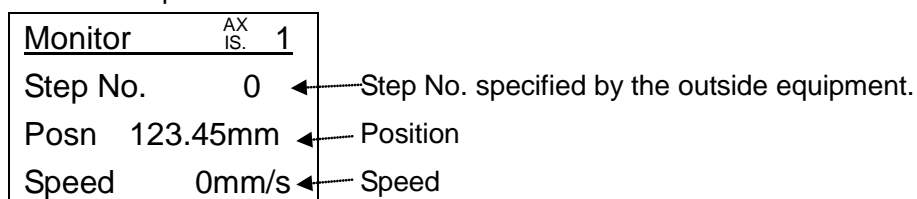

- ⑤ Operation check completed.

Press the “MENU” key or press the “ESC” key for several times to return to the menu screen.

(2) Operation check with monitor in normal mode

- ① Select the “Monitor” function.

Press the “MENU” key to shift to the menu screen.

Change the background color of “Monitor” to black by pressing the “ Δ ” key.

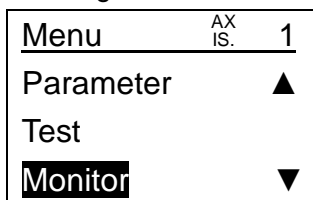

↓ Press the “SET” key.

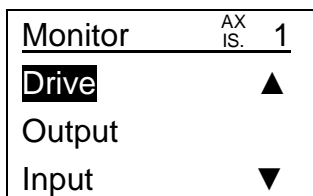

↓ Change the background color of “Drive” to black, and press the “SET” key.

- ② Specify the step number to be set by outside equipment.

Instruct the input of “IN*” of the controller by turning ON/OFF the manual switch or the outside equipment such as PLC.

(Refer to the operation manual of the connected controller.)

↓

- ③ Start driving by instruction from the outside equipment.

Turn ON the input “DRIVE” of the controller by a manual switch or outside equipment such as PLC and turn it off after positioning is completed.

(Refer to the operation manual of the connected controller.)

↓

- ④ Check operation.

Confirm if it is moved to the specified position by looking at the displayed position on the monitor screen and the actual position that the actuator moved to.

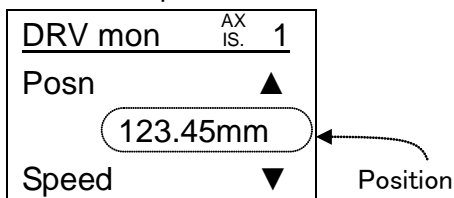

↓ Without problem

- ⑤ Operation check completed.

Press the “MENU” key or press the “ESC” key for several times to return to the menu screen.

6. Detail Functions

6.1 Step data

(1) Outline of step data

This actuator system is controlled by predefined step data stored in the controller. A step number in the form of digital code connected to the controller by external PLC can take charge of the actuator.

In normal mode: All items of the step data can be set.

In easy mode :

TB Ver1.**: Only "Posn(position)", "Speed", "Accel(Acceleration)", "Decel(Deceleration)" of the step data can be set in easy mode. However, it is possible to display only the items whose setting needs to be changed in easy mode if the items which cannot be set in easy mode are set in normal mode in advance.

TB Ver2.**: All items of the step data can be set.

Only two items can be displayed and set in "Easy mode / DATA"

The set item in "Easy mode / DATA" can be changed by changing the choice of "Easy mode / SETTING". Refer to "6.2 (3) ④ Change of the set item" for detail.

*Refer to "5.1(1)" to confirm TB Ver.

*The step data for LECSA is the setting that is not determined by pulse signal input such as positioning width.

External equipment

PLC, manual switch, etc.

Step data

When connecting to LECP or LECA:

Data which includes information such as "position", "speed", "acceleration" etc which are used for positioning of the actuator. One step data is needed for the positioning at one point.

When connecting to LECPA:

The step data for LECSA is the setting that is not determined by pulse signal input such as positioning width.

It can be set with the teaching box or the controller setup software.

When connecting to LECP or LECA, refer to "6.1 Step data" for detail of positioning and pushing operation.

(a) Positioning operation (When connecting to LECP or LECA)

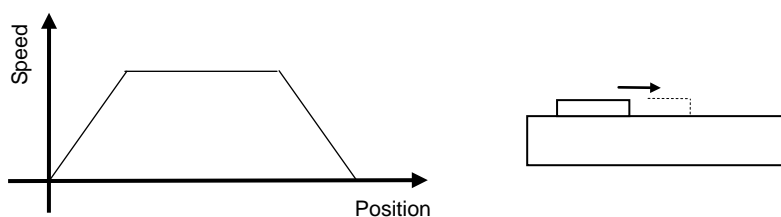

Operation, which moves to the specified position at the specified speed and acceleration. (Example: Moving from the original position to 100mm from the original position by sliding actuator)

(b) Pushing operation (When connecting to LECP or LECA)

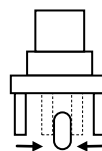
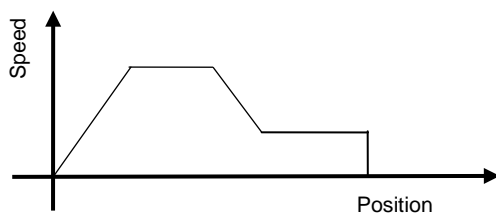

It makes positioning operation to the specified position, and moves for the specified distance at the specified speed after the positioning operation. If there is something such as workpiece during the operation, it keeps pushing with the specified force at maximum. (Ex: Holding a workpiece with a gripper.)

(2) Detail of step data setting items

(2-1) Step data setting items in positioning operation when connecting to LECP or LECA

Step data setting items in positioning operation

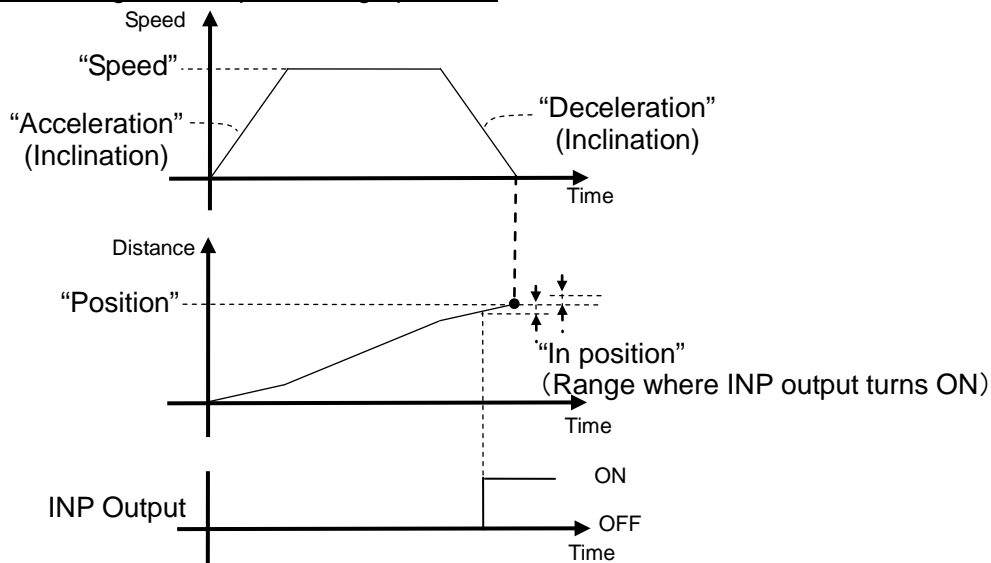

Set item	Description
Step No.	Number of the objective step data
Movement mode	Setting of movement to target position in absolute or relative (incremental) method. Absolute: Target position is set on the absolute position with the standard at the origin. Relative: Target position is set on the relative position with the current position. Disable : The step data of the set step number is disabled. *If the step data that "Movement mode(MV MOD)" is set to "Disable" is commanded to drive, the alarm "Step data ALM1" occurs.
Speed	Moving speed to the target position
Position	Target position which is used for positioning
Acceleration	Acceleration when accelerating
Deceleration	Deceleration when decelerating
Pushing force	Set to "0" for positioning operation. "0" : Positioning operation "1 to 100": Pushing operation
Trigger level	Disabled when positioning operation is specified.
Pushing speed	Disabled when pushing operation is specified.
Moving force	Maximum force during positioning operation No need to change the setting.
Area 1	It is the condition that AREA output turns ON AREA output turns ON when the current position is within the range between "AREA 1" and "AREA 2".
Area 2	AREA 2 must be greater than AREA 1. If it is instructed to operate under the conditions other than shown above, the alarm "Step data ALM1" occurs.
In position	It is the range where the INP output turns ON when the positioning operation is specified. INP output turns ON when the current position of the actuator is within the range of "In position" of the target position. * No need to change the setting.

(2-2) Step data setting items in pushing operation when connecting to LECP or LECA

Step data setting items in pushing operation

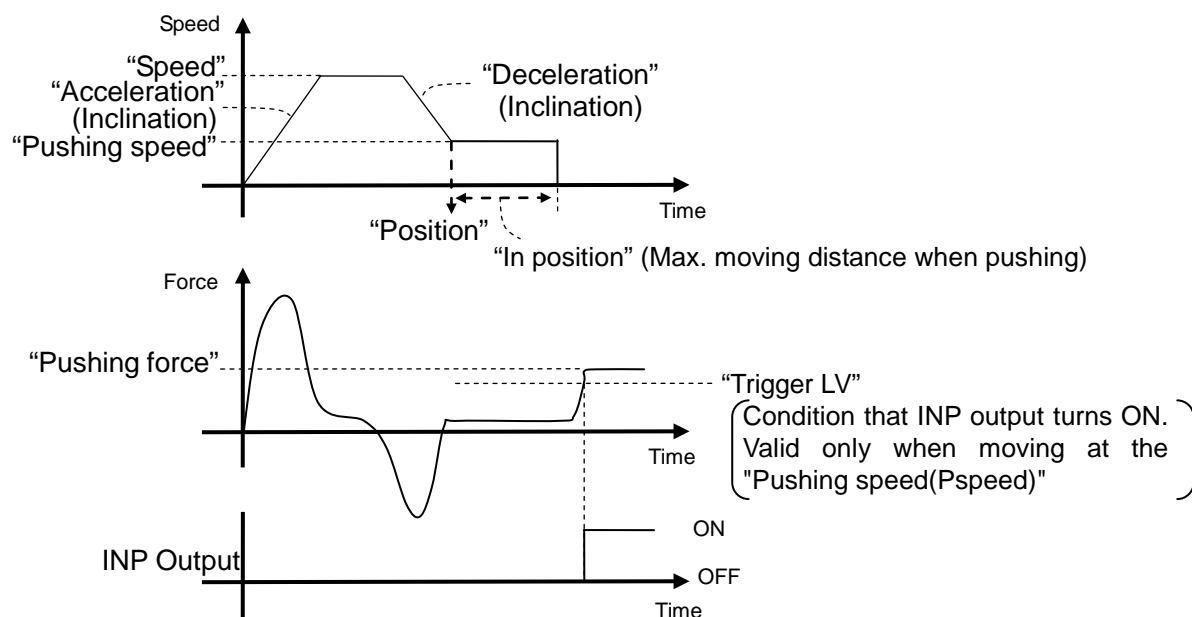

Set item	Description
Step No.	Number of the objective step data
Movement mode	Setting of movement to target position in absolute or relative (incremental) method. Absolute: Target position is set on the absolute position with the standard at the origin. Relative: Target position is set on the relative position with the current position. Disable : The step data of the set step number is disabled. *If the step data that "Movement mode(MV MOD)" is set to "Disable" is commanded to drive, the alarm "Step data ALM1" occurs.
Speed	Moving speed to the starting position of pushing
Position	Starting position of pushing
Acceleration	Acceleration when accelerating
Deceleration	Deceleration when decelerating
Pushing force	<u>Set value "From the minimum% operating force to 100%"</u> <u>(Refer to the actuator operation manual for the specification of the minimum operating force.)</u> "0" : To specify the positioning operation "1 to 100": To specify the pushing operation First, It moves to the position by the positioning operation, next, it moves the "In position" distance in the maximum at the speed by the pushing operation
Trigger level	Enable when pushing operation is specified. (Enable when "Pushing force" is set to 1% or more.) And, enable while the actuator is moving from the position of "Position" at the speed of "Pushing speed". It is the condition that INP output turns ON. INP output turns ON, when the pushing force is greater than the trigger LV. <u>"Pushing force" must be greater than "Trigger LV".</u> If it is instructed to operate under the conditions other than shown above, the alarm "Step data ALM1" occurs.

Pushing speed	Enable when pushing operation is specified. (Enable when "Pushing force" is set to 1% or more.) During pushing operation the "pushing speed" is applied from the pushing starting position. It damages the actuator if "pushing speed" is set to high speed.
Moving force	Maximum force during positioning operation (Movement to the position of "Position") No need to change the setting.
Area 1	It is the condition that AREA output turns ON. AREA output turns ON when the current position is within the range between "AREA 1" and "AREA 2".
Area 2	<u>AREA 2 must be greater than AREA 1.</u> If instructed to operate under the conditions other than shown above, the alarm "Step data ALM1" occurs.
In position	"InPosition" is the setting of the maximum moving distance for pushing when "Pushing force(Push force)" of the step data is set to "1" or more and a pushing operation is set. The INP output does not turn ON if object is not found and the actuator stops after moving the distance of "position". The INP output turns ON when the pushing force is "Trigger LV" or more if object is clamped within distance of "In position".

(2-3) Step data setting items when connecting to LECPA

Set item	Description
Step No.	Only step No. 0 is used.
Movement mode	Disabled when connecting to LECPA. However, set to "Absolute" or "Relative". *If the step data that "Movement mode(MV MOD)" is set to "Disable" is commanded to drive, the alarm "Step data ALM1" occurs.
Speed	Disabled when connecting to LECPA.
Position	Disabled when connecting to LECPA.
Acceleration	Disabled when connecting to LECPA.
Deceleration	Disabled when connecting to LECPA.
Pushing force	The maximum pushing force in the pushing operation. *For the set value, refer to the operation manual of the actuator used. *If "Pushing force" is set to "0", the alarm "Step data ALM1" occurs.
Trigger level	The condition that INP output turns ON in the pushing operation. INP output turns ON, when the pushing force is greater than the trigger LV. *For the set value, refer to the operation manual of the actuator used.
Pushing speed	The moving speed during pushing operation. *For the set value, refer to the operation manual of the actuator used.
Moving force	Maximum force during positioning operation No need to change the setting.
Area 1	The condition that AREA output turns ON. AREA output turns ON when the current position is within the range between "AREA 1" and "AREA 2".
Area 2	
In position	The condition that INP output turns ON in the positioning operation. INP output turns ON, when the deviation to the pulse signal from PLC is within "In position" range. *If the set value is too small, INP output turns ON during operation.

6.2 Detail easy mode functions

(1) Initial screen

① Display of the initial screen

It displays the initial screen when a controller is connected to the teaching box after the controller is supplied with power regardless of easy mode or normal mode.

*The version of the teaching box is displayed in the initial screen.

*Some functions are different depending on the teaching box version ("TB Ver").

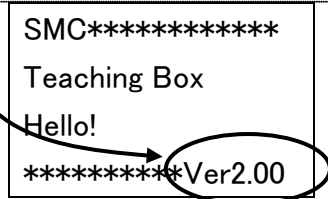

↓ After a few seconds

② Confirmation of the connection

Confirms automatically the controller connection after the initial screen is displayed.

*The time required for connection confirmation is varied depending on the set value of the maximum ID number of TB setting.

It takes ("Max. ID No." times 2[sec.]) at maximum.

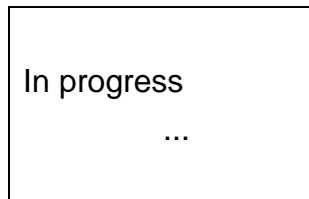

↓ After "Max. ID No." times 2[sec.]

③ Shifting to the menu screen.

(2) Easy mode "Menu"

● Every function can be executed by selecting the icons.

*When connecting to LECPA, the function "TEST" cannot be used.

TB Ver2.1 or more: When connecting to LECPA, the icon "TEST" cannot be selected.

The item with background color black is selected.

The function of the selected item is executed by pressing the "SET" key.

The teaching box powers up in easy mode when delivered from the factory, and the following screen is displayed when powered for the first time.

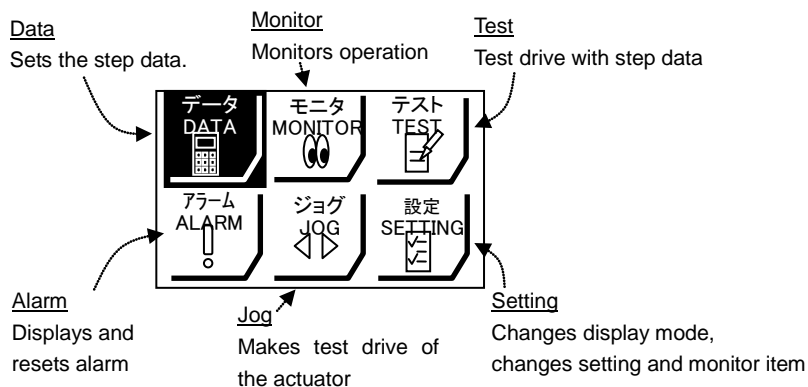

(3) Easy mode “DATA”

- Basic setting of the step data can be performed.
- The set items can be changed.

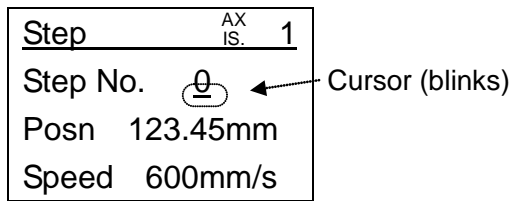

The item in the line with which the cursor blinks is selected for setting.

Move the cursor to the line of the item to be set by pressing the “Δ▽” key.

Input the set value with the number keys, and press the “SET” key to register.

- * The input value will be cancelled, if “Δ▽” key is pressed before pressing "SET" key,
- * Refer to “6.1 Step data” for the detail of step data setting items.
- * TB Ver1.**, the item to be set can be changed to “Position”, “Speed”, “Force(Pushing force)”, “Accel(Acceleration)” or “Decel(Deceleration)”. Refer to “6.2 (3) ④ Change of the set item” for detail.
It is not possible to set "Movement mode", “Pushing force”, “Trigger level”, “Pushing speed”, “Moving force”, “AREA 1 and 2” and “In position” in easy mode. The setting of these items applies the setting of the same step data number in normal mode. And the setting of these items is possible to be changed only in normal mode using the same step data number.
The default (factory set) is as follows.
“Movement MOD”: Stepdata No.0 & No.1→“Absolute”, Other stepdata→“Disable”
“Pushing force”, “Trigger LV”, “Pushing speed”, “Positioning force”, “AREA 1 and 2”, “In position” :Dependent on the actuator
To change the setting, follow these procedures.
a) In “Normal mode / Step data / Step No.”
Set it to the Step No. which is set in easy mode.
↓
b) Change the setting in “Normal mode/Step data/Set item.
- * TB Ver2.**, the item to be set can be changed to “Position”, “Speed”, “Force”, “Acceleration”, “Deceleration”, "Movement MOD", “Pushing force”, “Trigger LV”, “Pushing speed”, “Moving force”, “AREA 1 and 2” and “In position”. Refer to “6.2 (3) ④ Change of the set item” for detail.
- * TB Ver2.**, “Caution! Para protect” is displayed on the screen and the step data cannot be changed when “normal mode / Parameter / Basic / Para protect” setting is “2”. Refer to the operation manual of the controller.
- * TB Ver2.1* or more: When connecting to LECPA, the displayed step data is No.0 only.
- * If the step data that “Movement mode(MV MOD)” is set to “Disable” is commanded to drive, The alarm “Step data ALM1” occurs.
- * Refer to “5.1(1)” to confirm TB Ver.

① Setting of "Step No." (in the second line on the screen)

Specify the step No. to be set with the number keys, and press the "SET key".

② Setting of the item 1 (in the third line on the screen) ("Position" in the above example)

Input the set value with the number keys, and press the "SET" key to determine.

* The set item can be changed. Refer to "6.2 (3) ④ Change of the set item" for detail.

③ Setting of the item 2 (in the fourth line on the screen) ("Speed" in the above example)

Input the set value with the number keys, and press the "SET" key to determine.

* The set item can be changed to. Refer to "6.2 (3) ④ Change of the set item" for detail.

④ Change of the set item

TB Ver1.**, the set item 1 and 2 in the third line and the fourth line on the screen can be changed to "Position", "Speed", "Force (Pushing force)", "Accel(Acceleration)" or "Decel(Deceleration)".

TB Ver2.**, the set item 1 and 2 in the third line and the fourth line on the screen can be changed to "Position", "Speed", "Pforce(Pushing force)", "Accel(Acceleration)", "Decel(Deceleration)", "MV MOD(Movement mode)", "TrigLV(Trigger level)", "Pspeed(Pushing speed)", "Mforce(Moving force)", "Area1", "Area2" and "InPosn(In position)".

* Refer to "5.1(1)" to confirm TB Ver.

* The set items which can be changed are different in easy mode from in normal mode.

* The set item 1 is monitored in the "Test drive" and "JOG/MOVE".

Item	Easy mode	Normal mode
Set item 1 (in 3 rd line on the screen)	Cannot be changed	Can be changed
Set item 2 (in 4th line on the screen)	Can be changed	Can be changed

a) How to change the set item 1 (in the 3rd line on the screen) in easy mode

Refer to "6.2 (8) ③ Setting of "Set item"" for how to change.

b) How to change the set item in normal mode

Set it in "Normal mode / Parameter / Default / TB setting".

Change it into normal mode when it is in easy mode.

Refer to "5.2 (1) How to change from easy mode to normal mode".



Change the background color of "Parameter" to black on the menu screen, and press the "SET" key.

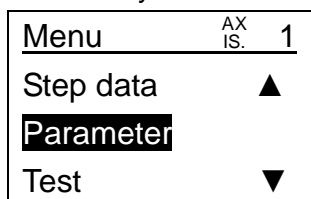

↓ Press the "SET" key.

Change the background color of the default parameter to black, and press the “SET” key.

* "Default parameter" cannot be changed depending on the registered value of the default parameter "Parameter protect". Refer to the operation manual of the controller.

2nd digit: Setting of the set item1 in easy mode
1st digit: Setting of the set item2 in easy mode

Set value	Easy mode data and monitor display	
	TB Ver	
	Ver1.**	Ver2.**
1	Position	Position
2	Speed	Speed
3	Force (Pushing force)	PForce (Pushing force)
4	Accel	Accel
5	Decel	Decel
6	—	MV MOD (Movement mode)
7	—	InPosn (In position)
8	—	TrigLV (Trigger level)
9	—	Pspeed (Pushing speed)
A	—	Mforce (Moving force)
B	—	Area1
C	—	Area2

↓ Press “SET” key.
Setting completed.

*Refer to “5.1(1)” to confirm TB Ver.

“—”: Invalid set value

(4) Easy mode “MONITOR”

- Possible to check the real time “Position”, “Speed”, etc.
- Display items can be changed.

The display items can be changed to “Posn (Position)”, “Speed”, “Force (Pushing force)”, “Accel (Acceleration)” or “Decel (Deceleration)”. Refer to “6.2 (3) ④ Change of the set item” for detail.

The displayed items of the display item 1 (in the 3rd line) and display item 2 (in the fourth line) and the “DATA” in easy mode are the same.

Monitor	AX IS.	1
Step No.	0	
Posn	123.45mm	
Speed	600mm/s	

(5) Easy mode “JOG”

- The actuator can be operated at the speed set with the parameter while “JOG+” and “JOG-“ keys are pressed.

① When “JOG” function is selected

“EXT Inp OFF” and “Servo ON, Ready?” are confirmed when pressing the “SET” key after “JOG” function is selected from the MENU.

a) “EXT Inp OFF”

It is to confirm whether to disable the input from outside equipment such as PLC to CN5 terminal of the controller.

It is necessary to disable external input in order to have “JOG” operation.

Display the “YES” in black highlight by pressing the “◀▶” key and press the “SET” key to disable the input.

Check	AX IS.	1
EXT Inp OFF		
Yes No		
Check safety!!!		

↓ Select “Yes” and press the “SET” key.

b) “Servo ON, Ready?”

It is to confirm the motor power to be turned ON (servo ON).

It is confirmed only when the motor power is OFF (servo OFF).

It is possible to have JOG operation only when the motor power is ON.

Display the “YES” in black highlight by pressing the “◀▶” key and press the “SET” key to turn the motor power ON.

Check	AX IS.	1
Servo ON,Ready?		
Yes No		
Status:ServoOFF		

↓ Select “YES” and press the “SET” key.

c) JOG screen

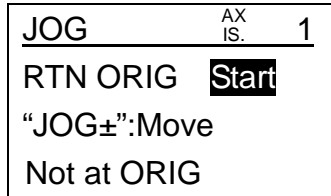

② “Return to ORIG” (in the second line on the screen)

If returning to origin has not been executed, it shows “Not at ORIG” in the fourth line on the screen.

a) Execution of return to origin

Display the “Start” in the line of the “Return to ORIG” in the black highlight by pressing the “△▽” key, and press the “SET” key to start returning to origin.

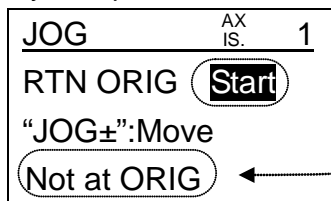

↓ Select “START” and press the “SET” key.

b) Return to origin completed.

It displays “Start” and then “Stop” when returning to origin, and then displays “Stop” and then “Complete” when completed.

It discontinues returning to origin and stops if the “SET” key is pressed while it displays “Stop”.

It is necessary to start returning to origin again and operate until it displays “Complete” to complete returning to origin.

The position will be displayed in the fourth line on the screen after it is completed.

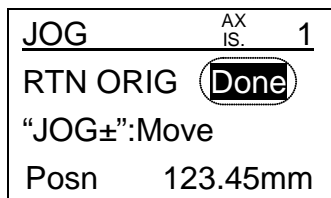

↓ Press the “▽” key.

③ “MOVE” (in the 3rd line on the screen)

JOG/Move operation is possible by pressing either “JOG+” key or “JOG-“ key after changing the background color of “JOG±:MOVE” (in the 3rd line on the screen) to black.

The position is displayed in the 4th line on the screen.

* The operation speed when "JOG+" key or "JOG-" key is pressed is according to the set value of the “JOG speed (operation parameter)”. This parameter (JOG speed) can be changed in normal mode.

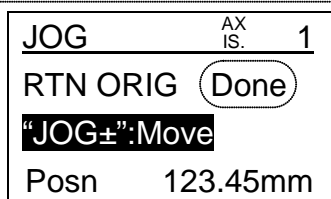

(6) Easy mode “TEST”

● Test drive of the arbitrary step data can be done.

*When connecting to LECPA, the function “TEST” cannot be used.

TB Ver2.1 or more: When connecting to LECPA, the icon “TEST” cannot be selected.

① When “TEST” function is selected

“EXT Inp OFF” “Servo ON, Ready?” and “Return to origin” are confirmed when pressing the “SET” key after “TEST” function is selected from the MENU.

a) “EXT Inp OFF”

It is to confirm whether to disable the input from outside equipment such as PLC to CN5 terminal of the controller.

It is necessary to disable the input from outside to do “Test drive” operation.

Display the “YES” in black highlight by pressing the “ $\leftarrow \rightarrow$ ” key and press the “SET” key to disable the input.

Check	AX IS.	1
EXT Inp OFF		
Yes	No	
Check safety!!!		

↓ Select “Yes” and press the “SET” key.

b) “Servo ON, Ready”

It is to confirm the motor power to be turned ON (servo ON).

It is confirmed only when the motor power is OFF (servo OFF).

It is possible to have test drive operation only when the motor power is ON.

Display the “YES” in black highlight by pressing the “ $\leftarrow \rightarrow$ ” key and press the “SET” key to turn the motor power ON.

Check	AX IS.	1
Servo ON,Ready?		
Yes	No	
Status:ServoOFF		

↓ Select “YES” and press the “SET” key.

c) “Return to origin”

To confirm whether to return to origin.

It is displayed only when returning to origin has not been executed after switching the power supply of controller on.

Display the “YES” in black highlight by pressing the “ $\leftarrow \rightarrow$ ” key and press the “SET” key to return to origin.

RTN ORIG	AX IS.	1
Return to ORIG		
Yes	No	
Not at ORIG		

↓ After returning to origin is completed.

② Setting of "STEP No." (in the 2nd line on the screen)

Input the step number for test drive with the number keys, and press "SET" key.

Test	AX IS.	1
Step No.	20	
Test	Start	
Posn	123.45mm	

↓ Press the "▽" key.

③ "Test drive" (in the 3rd line on the screen)

Display the "Start" in the line of "Test" in the black highlight in the test screen by pressing the "△▽" key, and press the "SET" key to start the test drive of the data of the set step number.

The display "Start" will be changed to "Stop" after the test drive is started, and it displays "Stop" and then "Complete" when it is completed.

It will be compulsorily stopped if "SET" key is pressed while "Stop" is displayed.

Test	AX IS.	1
Step No.	20	
Test	Start	
Posn	123.45mm	

(7) Easy mode "ALARM"

- The active alarm can be confirmed and reset.

(It is automatically displayed when alarm is generated.)

- * Refer to the operation manual of the connected controller for the description of the alarm.
- * Reset the alarm when the alarm particular to TB is generated. (Refer to 6.3 (7-3-4) for detail.)

① Active alarm

Content of the alarm can be displayed up to two.

ALM	AX IS.	1
1.	Over speed	
2.		
"SET":	ALM reset	

② Alarm reset

The alarm can be reset when "SET" key is pressed while alarm is displayed.

However, some alarm cannot be reset unless the cause of the alarm is removed and the power supply of the controller is turned on.

(Refer to the operation manual of the controller.)

(8) Easy mode “SETTING”

● TB Ver1.**:

Reconnect of the axis, selection of easy mode / normal mode, and display item setting in easy mode can be set.

● TB Ver2.**:

Selection of the display language that is English or Japanese, selection of easy mode or normal mode, and display item setting in easy mode can be set.

*Refer to “5.1(1)” to confirm TB Ver.

①-1 TB ver1.**: “Reconnect” (in the 2nd line on the screen)

Display the “Start” in the line of “Reconnect” in the black highlight in the test screen by pressing the “△▽” key, and press the “SET” key to reconfirm the controller in connection.

TB Ver1.**

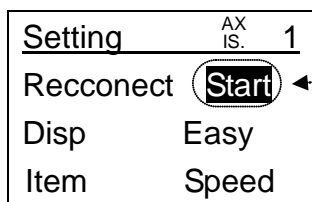

Change the background color of “START” to black and press the “SET” key.

①-2 TB ver2.**: “Language” (in the 2nd line on the screen)

Change the language displayed of the teaching box to English or Japanese.

Select either “Eng” or “Jpn” in the line of “Language” with the “◀▶” key, and press the “SET” key to determine.

TB Ver2.**

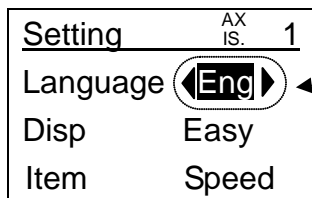

Select with the “◀▶” key and press the “SET” key to determine.

② Setting of “Disp” (in the 3rd line on the screen)

Change the display mode setting of the teaching box to easy mode or normal mode.

Select either “Easy” or “Normal” in the line of “Disp” with the “◀▶” key, and press the “SET” key to determine.

* It restarts from the initial screen (refer to 5.1 (1)) when the “SET” key is pressed.

TB Ver1.**

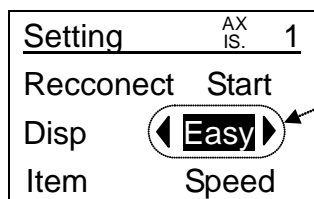

Select with the “◀▶” key and press the “SET” key To determine.

TB Ver2.**

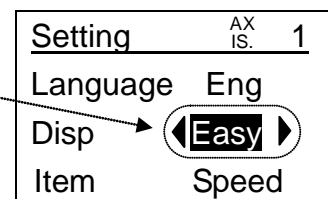

③ Setting of "Item" (in the 4th line on the screen)

Select the item to be displayed in the 4th line on the screen when "DATA" and "MONITOR" are selected in easy mode from "Posn (Position)", "SPEED", "Force(Pushing force)", "Accel(Acceleration)" and "Decel(Deceleration)", and press the "SET" key to determine.

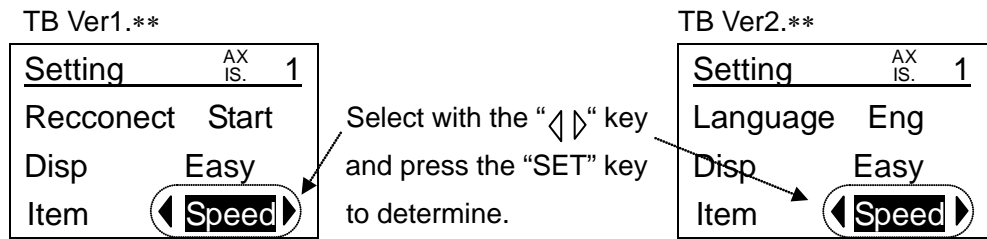

6.3 Detail normal mode functions

(1) Initial screen

Regardless of normal mode or easy mode, the following items are checked once the power supply is applied to the controller and the teaching box is connected to it.

(Refer to “6.2 (1) Initial screen” for details.)

1. Initial screen
 - ↓ After a few seconds
2. Connection is checked.

* The time to check connection is dependent on the TB settings “Max ID No.”
 The time to check the ID number is calculated from the following equation.
 (“Max ID No.” x 2 [sec].)

(2) Normal mode “Menu”

● It is possible to select and execute the functions.

* Note that step data may not be set depending on the “Parameter protect” registered value in the basic parameter. Refer to the “Controller operation manual” for details.

(2-1) Menu screen

The selected item is shown in black highlight.

The function of the selected item is executed by pressing the “SET” key.

Menu	AX IS. 1
Step data	▲
Parameter	
Test	▼

(2-2) Menu items

The menu items in normal mode are changed as follows.

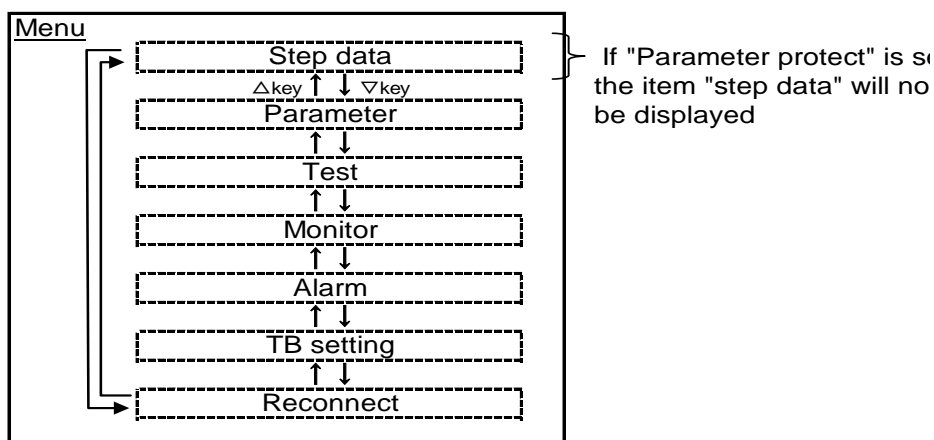

(3) Normal mode “Step data”

● All the step data entries can be set in detail.

TB Ver2.1 or more: When connecting to LECPA, the displayed step data is No.0 only.

(3-1) Step data setting screen

* Refer to “6.1 Step data” for the detailed content of the step data setting items.

(3-1-a)TB Ver1.**

*Refer to “5.1(1)” to confirm TB Ver.

① Selection and setting of the item “Step data No.”.

When setting the step data, select the item “Step No.” first and decide the step data No. to be set.

The item that is currently selected is shown in the second line of the screen.

The setting content of the selected item is shown in the third line of the screen.

When the item “Step No.” is selected with the “Δ▽” keys, the cursor under the setting content of the step data No. flashes.

After entering the step data No. with number keys, press the “SET” key.

* If the “Δ▽” key is pressed without pressing the “SET” key, the input values and changed choice are cancelled.

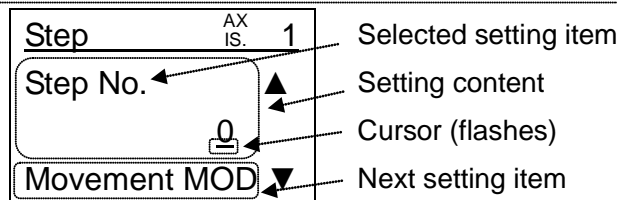

↓ Press the “▽” key for several times.

② Setting of the step data content.

The items to be set can be selected with the “Δ▽” key.

When there are some choices for setting: Displayed with black highlight
 When numbers are used for setting: Pointed by cursor.

In each setting, the number is input with number keys and the choices are changed with the “◀ ▶” key, and those values and choices are set with the “SET” key.

* If the “Δ▽” key is pressed without pressing the “SET” key, the input values and changed choices are cancelled.
 * Refer to “Controller operation manual” of the connected controller for the content of the step data set items.

Step data screen (When there are some choices for setting.)

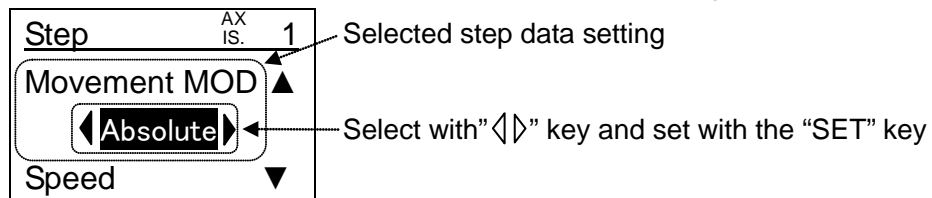

Step data screen (When numbers are used for setting.)

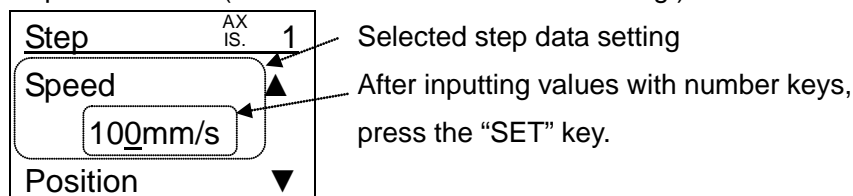

(3-1-b)TB Ver2.**

*Refer to “5.1(1)” to confirm TB Ver.

① Selection and setting of the step data item

When setting the step data, select the step data item at first.

The item displayed in the second line on the screen is the step data item selected currently.

The step data No. is displayed in the left side of vertical dotted line on the screen.

The setting content corresponding to the step data No. is displayed in the right side of vertical dotted line on the screen.

Select the item with the “◀▶” key.

The step data No. and the setting content corresponding to the step data No. can be changed with the “△▽” key.

The setting content of 2 step data can be displayed on the screen.

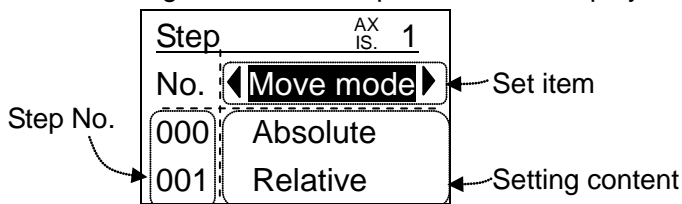

② Setting of the content of the step data item.

a) Selection of the setting content

When the set item is selected, press the “SET” key, and the setting content is selected.

(Refer to the figure below)

When there are some choices for setting: Displayed with black highlight
 When numbers are used for setting: Pointed by cursor.

When the setting content is selected, press the “ESC” key, and the set item is selected.

(Refer to the figure below)

When the setting content is the choice.

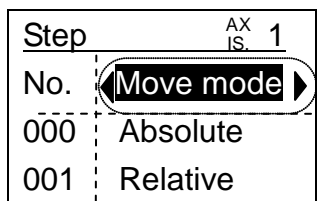

ESC key ↑ ↓ SET key

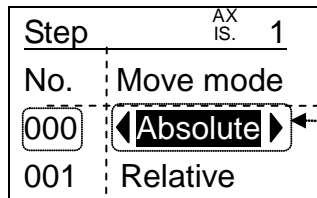

When the setting content is the numerical value.

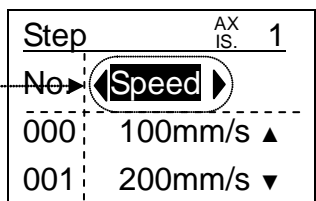

ESC key ↑ ↓ SET key

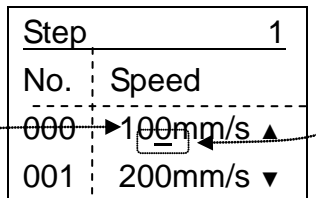

b) Setting of the step data content

In each setting, the number is input with number keys and the choices are changed with the “◀▶” key, and those values and choices are set with the “SET” key.

Refer to “Controller operation manual” of the connected controller for the content of the step data set items

When the setting content is the choice.

Step	AX IS.	1
No.	◀ Move mode ▶	
000	Absolute	
001	Relative	

Select with “◀▶” key and set with the “SET” key

When the setting content is the numerical value.

Step	AX IS.	1
No.	◀ Speed ▶	
000	300mm/s ▲	
001	200mm/s ▼	

Input values with number keys, and set with the “SET” key.

(3-2) Step data setting items

The step data setting items in normal mode are changed as follows.

*Refer to “5.1(1)” to confirm TB Ver.

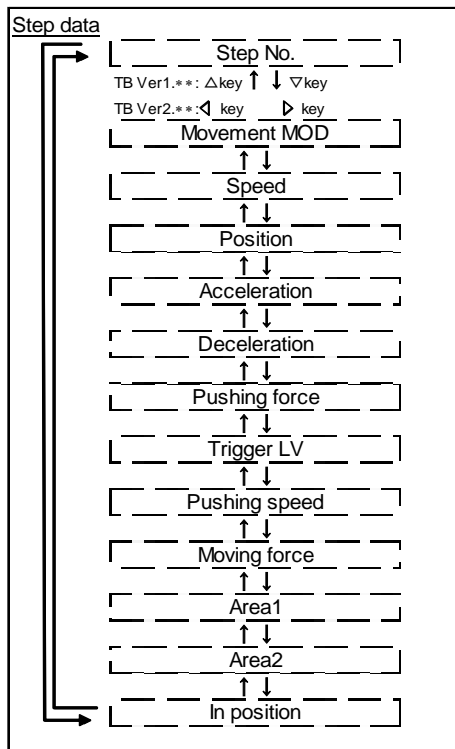

(3-3) Setting of “Position” (When connecting to LECP or LECA)

When setting the position, input method and selected from “number”, “JOG” and “direct” and specified position can be registered.

- “Key pad entry” : Entering of the position by the numeric keys.
⇒ Refer to “6.3 (3-3-1)”
- “JOG input” : Entering the stopping position, after the actuator is moved by JOG/MOVE.
⇒ Refer to “6.3 (3-3-2)”
- “Direct input” : Entering the stopping position, after the actuator has been moved manually.
⇒ Refer to “6.3 (3-3-3)”

(3-3-1) Entry of the "position value" using number keys (When connecting to LECP or LECA)

*Refer to "5.1(1)" to confirm TB Ver.

① Selection of "Position" setting.

Show "Position" which is the step data setting item on the second line on the screen.

TB Ver1.** : When "Position" is shown, the set data is selected. (Cursor flashes)

TB Ver2.** : When the SET key is pressed, the set data is selected. (Cursor flashes) TB

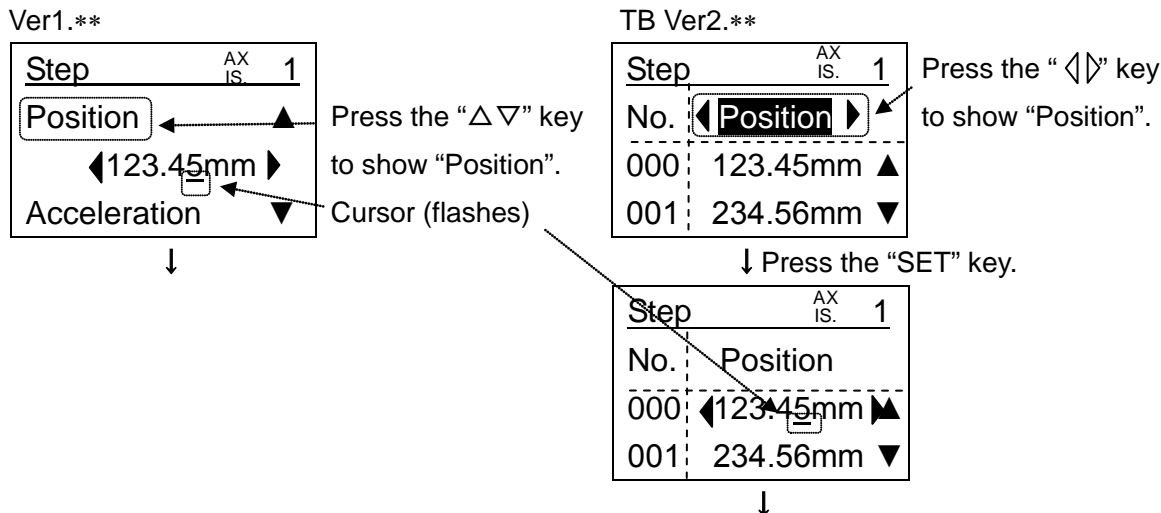

② Selection of the number input.

Press "◀▶" key to show numerical value.

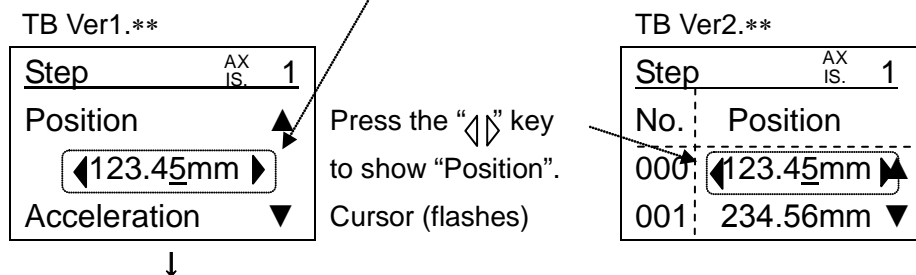

③ Registration of position

Input the position with number keys and register the value by pressing the "SET" key.

The input "Position" is registered to the specified step data No. by pressing the "SET" key.

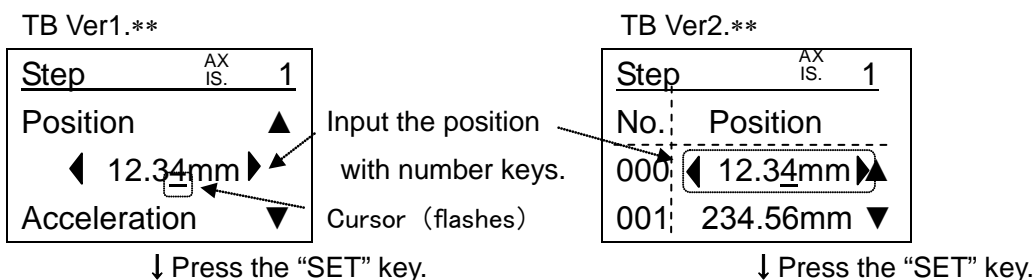

④ Completed.

(3-3-2) Entry of the "position value" using "JOG input" (When connecting to LECP or LECA)

① Selection of "Position" setting.

Show "Position" which is the step data setting item on the second line on the screen

TB Ver1.** : When "Position" is shown, the set data is selected. (Cursor flashes)

TB Ver2.** : When the SET key is pressed, the set data is selected. (Cursor flashes)

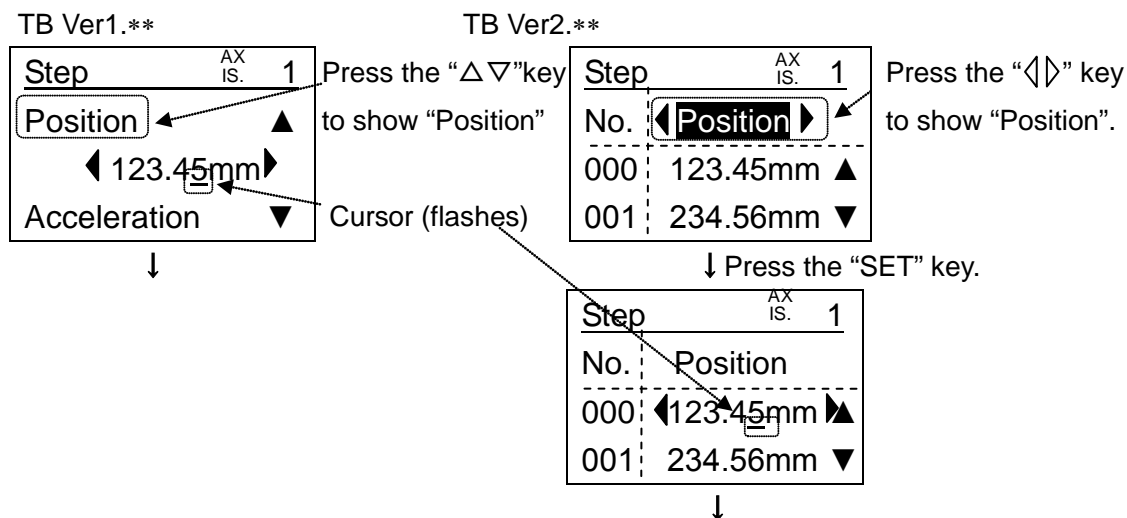

② Selection of the JOG input.

After selecting "JOG" with "◀▶" key, press the "SET" key.

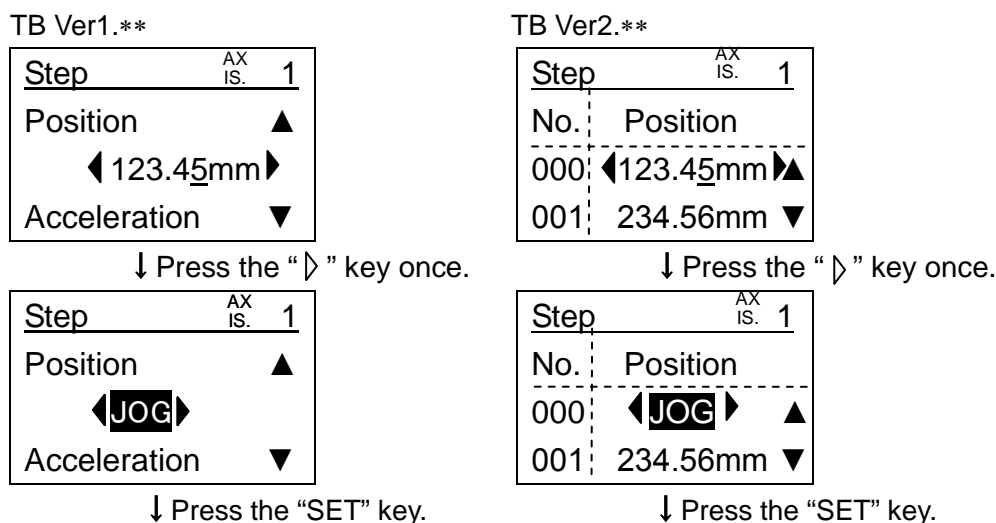

③ "EXT Inp OFF"

It is to confirm whether to disable the input from external equipment such as PLC to CN5 terminal of the controller.

It is necessary to disable the input from external "JOG input" operation.

Display the "YES" in black highlight by pressing the "◀▶" key and press the "SET" key to disable the input.

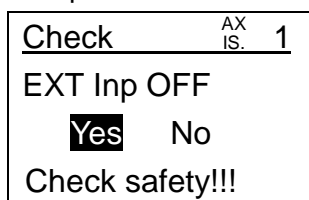

↓ Select "Yes" and press "SET" key.

④ “Servo ON, Ready”

It is to confirm the motor power to be turned ON (servo ON).

It is confirmed only when the motor power is OFF (servo OFF).

It is possible to have “JOG input” operation only when the motor power is ON.

Display the “YES” in black highlight by pressing the “◀▶” key and press the “SET” key to turn the motor power ON.

Check	AX	1
IS.		
Servo ON,Ready?		
Yes	No	
Status:ServoOFF		

↓ Select “Yes” and press “SET” key.

⑤ ”Return to origin”

To confirm whether to return to origin.

It is displayed only when returning to origin has not been executed after switching the-power supply of controller on.

Display the “YES” in black highlight by pressing the “◀▶” key and press the “SET” key to return to origin.

RTN ORIG	AX	1
IS.		
Return to ORIG		
Yes	No	
Not at ORIG		

↓ After return to origin position is completed.

⑥JOG speed setting

After inputting the JOG speed with number keys, press the “SET” key.

Posn(JOG)	AX	1
IS.		
Speed	▲	
100mm/s		
Move distance	▼	

↓ Press the “▽” key.

⑦Move distance setting

After inputting the move distance with number keys, press the “SET” key.

Posn(JOG)	AX	1
IS.		
Move distance	▲	
5.00mm		
JOG/MOVE	▼	

↓ After inputting the move distance with number keys, press the “Set” key.

⑧ Registration of position

“JOG+”, “JOG-”, “MOVE+”, “MOVE-” keys become active, then move the actuator by those keys.

The stop position is registered to the specified step data No. by pressing the “SET” key.

Posn(JOG)	AX IS.	1
JOG/MOVE		
Posn	12.34mm	
“JOG/MOVE”:Mov		
e		

↓ Press the “SET” key.

⑨ “EXT Inp ON”

To confirm whether to enable the input from external equipment such as PLC to CN5 terminal of the controller.

The actuator operates according to the input from outside equipment such as PLC when the input from external equipment is enabled.

Press the “SET” key after checking that safety is well secured.

Warning
<p>Confirm safety when recovering of input before pressing the SET key to determine “OK”. The actuator may operate suddenly when the input from external equipment such as PLC is received.</p>

↓ After Checking safety, press the “SET” key.

⑩ Completed.

The step data setting screen is automatically displayed.

(3-3-3) Entry of the “position value” using “Direct input” (When connecting to LECP or LECA)

① Selection of “Position” setting.

Show “Position” which is the step data setting item on the second line on the screen.

TB Ver1.**: When “Position” is shown, the set data is selected. (Cursor flashes)

TB Ver2.**: When the SET key is pressed, the set data is selected. (Cursor flashes)

TB Ver1.**		TB Ver2.**																								
<table border="1"> <tr> <td>Step</td> <td>AX IS.</td> <td>1</td> </tr> <tr> <td>Position</td> <td></td> <td></td> </tr> <tr> <td>◀ 123.45mm ▶</td> <td></td> <td></td> </tr> <tr> <td>Acceleration</td> <td></td> <td></td> </tr> </table>	Step	AX IS.	1	Position			◀ 123.45mm ▶			Acceleration			<p>Press the “△▽”key to show “Position”</p> <p>Cursor (flashes)</p>	<table border="1"> <tr> <td>Step</td> <td>AX IS.</td> <td>1</td> </tr> <tr> <td>No.</td> <td>Position</td> <td></td> </tr> <tr> <td>000</td> <td>123.45mm ▲</td> <td></td> </tr> <tr> <td>001</td> <td>234.56mm ▼</td> <td></td> </tr> </table> <p>Press the “◀▶” key to show “Position”.</p>	Step	AX IS.	1	No.	Position		000	123.45mm ▲		001	234.56mm ▼	
Step	AX IS.	1																								
Position																										
◀ 123.45mm ▶																										
Acceleration																										
Step	AX IS.	1																								
No.	Position																									
000	123.45mm ▲																									
001	234.56mm ▼																									
↓		↓ Press the “SET” key.																								
		<table border="1"> <tr> <td>Step</td> <td>AX IS.</td> <td>1</td> </tr> <tr> <td>No.</td> <td>Position</td> <td></td> </tr> <tr> <td>000</td> <td>◀ 123.45mm ▶</td> <td></td> </tr> <tr> <td>001</td> <td>234.56mm ▼</td> <td></td> </tr> </table>	Step	AX IS.	1	No.	Position		000	◀ 123.45mm ▶		001	234.56mm ▼													
Step	AX IS.	1																								
No.	Position																									
000	◀ 123.45mm ▶																									
001	234.56mm ▼																									
		↓																								

② Selection of the direct input.

After selecting "Direct" with "◀▶" key, press the "SET" key.

Step	AX IS. 1
Position	▲
◀123.45mm▶	
Acceleration	▼

↓ Press the "▶" key twice.

Step	AX IS. 1
Position	▲
◀Direct▶	
Acceleration	▼

↓ Press the "SET" key.

Step	AX IS. 1
No.	Position
000	◀123.45mm▶▲
001	234.56mm ▼

↓ Press the "▶" key twice.

Step	AX IS. 1
No.	Position
000	◀Direct▶▲
001	234.56mm ▼

↓ Press the "SET" key.

③ "EXT Inp OFF"

To confirm whether to disable the input from external equipment such as PLC to CN5 terminal of the controller.

It is necessary to disable the input from external to do "Direct input" operation.

Display the "YES" in black highlight by pressing the "◀▶" key and press the "SET" key to disable the input.

Check	AX IS. 1
EXT Inp OFF	
Yes No	
Check safety!!!	

↓ Select "Yes" and press "SET" key.

④ "Servo ON, Ready"

To confirm the motor power to be turned ON (servo ON).

It is confirmed only when the motor power is OFF (servo OFF).

It is possible to have "JOG input" operation only when the motor power is ON.

Display the "YES" in black highlight by pressing the "◀▶" key and press the "SET" key to turn the motor power ON.

Check	AX IS. 1
Servo ON,Ready?	
Yes No	
Status:ServoOFF	

↓ Select "Yes" and press "SET" key.

⑤ "Return to origin"

To confirm whether to return to origin.

It is displayed only when returning to origin has not been executed after switching the power supply of controller on.

Display the "YES" in black highlight by pressing the "◀▶" key and press the "SET" key to return to origin.

RTN ORIG	AX IS.	1
Return to ORIG		
Yes	No	
Not at ORIG		

↓ After return to origin position is completed.

⑥ Servo OFF

After "Status" is selected to "ServoOFF", press "SET" key.

Posn (DIR)	AX IS.	1
Status	◀ ServoOFF ▶	
Posn	12.34mm	
"SET": Save Posn		

↓ Press "SET" key

⑦ "Execute?"

To confirm whether to turn the servo OFF.

After confirming safety, select "YES" and press the "SET" key to execute.

 Warning
Actuators with brake: It maintains the brake even if the servo OFF is executed, and it will not accept direct input. Confirm safety and release the brake with the "BK RLS" pin of the controller CN1 to execute the direct input.

Check	AX IS.	1
Execute?		
Yes	No	

↓ Select "YES" and press the "SET" key.

⑧ Select the "Posn" data

Display the current position data in the line of "Posn" in the black highlight by pressing the "△▽" keys.

*It keeps displaying (without change) the position data when servo OFF was executed if the position is not selected.

Posn(DIR)	AX	1
Status	ServoOFF	
Posn	23.45	mm
"SET":Save Posn		



⑨ Registration of the position

Move the moving part of the actuator such as table by hand to determine the position.

The position is registered to the specified step data No. by pressing the "SET" key.

↓ Press the "SET" key.

⑩ "EXT Inp ON"

To confirm whether to enable the input from external equipment such as PLC to CN5 terminal of the controller.

The actuator operates according to the input from external equipment such as PLC when the input from external equipment is enabled.

Press the "SET" key after checking that safety is well secured.

 **Warning**

Confirm safety when recovering of input before pressing the SET key to determine "OK".

The actuator may operate suddenly when the input from external equipment such as PLC is recovered.

↓ After Checking safety, press the "SET" key.

⑪ Completed

The step data setting screen automatically displayed.

(4) Normal mode "Parameter"

- Parameters can be set.

The available parameter groups are changed by the "parameter protect" registered value in the basic parameter. Refer to the "Controller operation manual" for details.

(4-1) Parameter group selecting screen

The items to be selected can be changed with the "Δ▽" key.

The selected item is shown in black highlight.

The parameters in the parameter group can be set with the "SET" key.

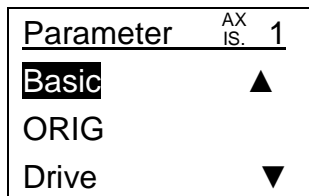

(4-2) Parameter group

The items in the parameter group are changed as follows.

Note that those are changed with the "parameter protect" registered value in the basic parameter.

Refer to the "Controller operation manual" for detail.

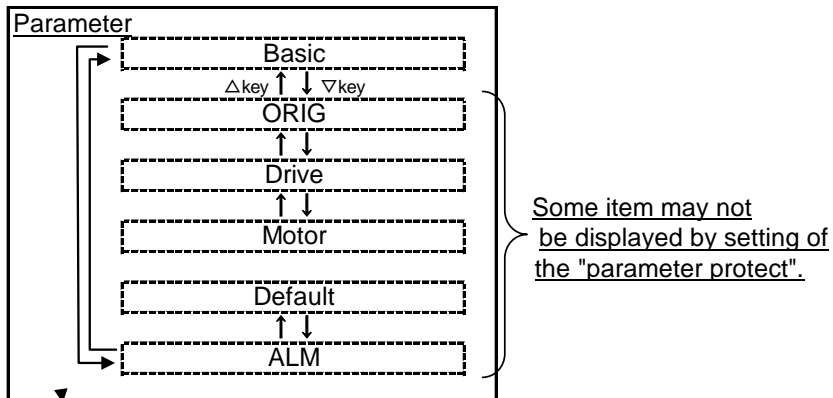

(4-3) Parameter setting

(4-3-1) Parameter setting screens and how to set the parameter

① Parameter item selection

Select the item to be set with the “△▽” key.

When there are some choices for the setting: Displayed in black highlight
 When numbers are used for setting : Indicated by cursor.

The item that is displayed in the second line of the screen is the item that is selected currently.

The setting (numbers or choices) is displayed in the third line of the screen.

Parameter setting screen (When numbers are used for setting.)

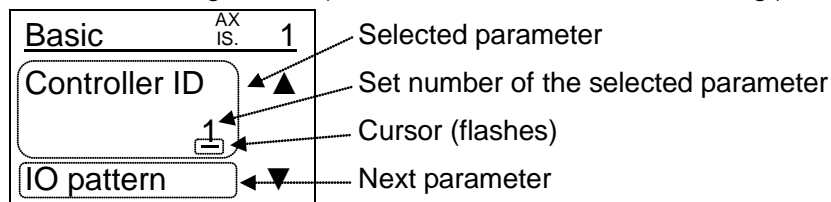

Parameter setting screen (When there are some choices for the setting.)

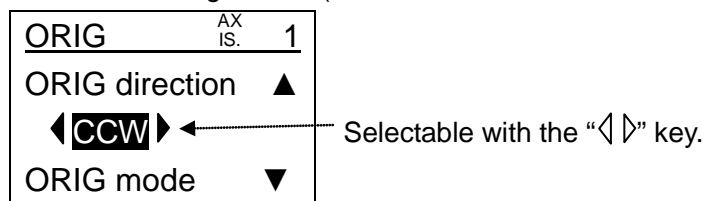

② Parameter setting

With each setting, the number is input with number keys and the choices are changed with the “◀▶” key, and those values and choices are registered with the “SET” key.

- * If the “△▽” key is pressed without pressing the “SET” key, the input values and changed choices are cancelled.
- * Refer to the “Controller operation manual” for the content of each parameter.

Parameter setting screen (When numbers are used for setting.)

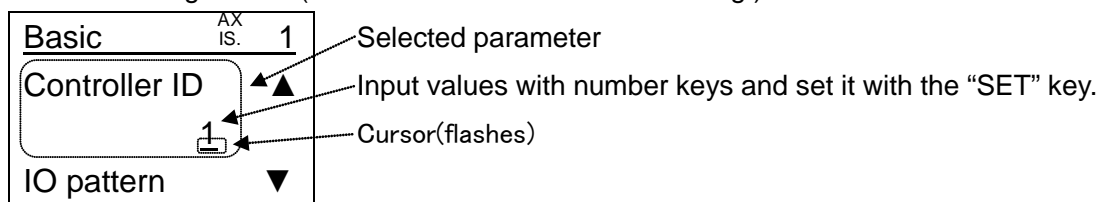

Parameter setting screen (When there are some choices.)

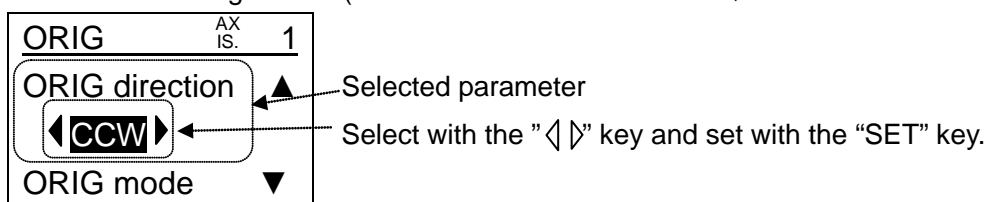

(5) Normal mode “Test”

●The test of “JOG/MOVE”, “Return to origin”, “Test drive” and “Force output” is possible.

*When connecting to LECPA, the function “Test drive” cannot be used.

TB Ver2.1 or more: When connecting to LECPA, the item “Test drive” is not displayed in “Test “ menu.

(5-1) Test selection screen

Items to be selected can be changed with the “Δ▽” key.

The selected item is shown in black highlight.

When the item is set with the “SET” key, the selected item is tested.

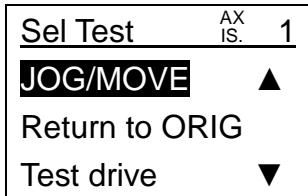

(5-2) Test items

The test items are changed as follows.

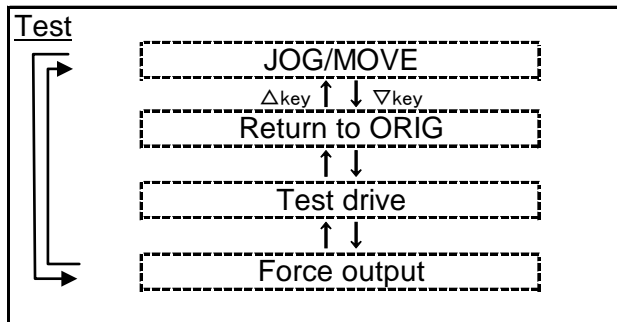

(5-3) Test details

(5-3-1) “JOG/MOVE”

●The JOG and MOVE operation is possible with the “JOG+”, “JOG-“, “MOVE+” and “MOVE-“ key.

(5-3-1-1) JOG/MOVE screen and the operating procedure

①Select the item “JOG/MOVE”.

Display “JOG/MOVE” in black highlight in the test selecting screen by pressing the “Δ▽” key and press the “SET” key.

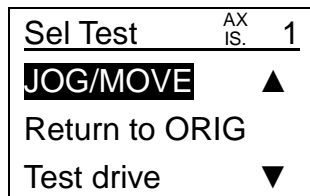

↓ Press the “SET” key.

②“EXT Inp OFF”

To confirm whether to disable the input from external equipment such as PLC to CN5 terminal of the controller.

It is necessary to disable the input from external to do “JOG/MOVE” operation.

Display the “YES” in black highlight by pressing the “◀▶” key and press the “SET” key to disable the input.

Check	AX IS.	1
EXT Inp OFF		
Yes	No	
Check safety!!!		

↓ Select “Yes” and press “SET” key.

③“Servo ON, Ready”

To confirm the motor power to be turned ON (servo ON).

It is confirmed only when the motor power is OFF (servo OFF).

It is possible to have “JOG/MOVE” operation only when the motor power is ON.

Display the “YES” in black highlight by pressing the “◀▶” key and press the “SET” key to turn the motor power ON.

Check	AX IS.	1
Servo ON,Ready?		
Yes	No	
Status:ServoOFF		

↓ Select “Yes” and press “SET” key.

④“Return to origin”

To confirm whether to return to origin.

It is displayed only when returning to origin has not been executed after switching the-power supply of controller on.

Display the “YES” in black highlight by pressing the “◀▶” key and press the “SET” key to return to origin.

RTN ORIG	AX IS.	1
Return to ORIG		
Yes	No	
Not at ORIG		

↓ After return to origin position is completed.

⑤“JOG speed” setting

Input the speed of the jog and move operation with number keys and press the “SET” key.

JOG	1
Speed	
100mm/s	
Move distance	▼

↓ Press the “▽” key.

⑥“Move distance” setting

Input the distance at the move operation with number keys and press the “SET” key.

JOG	1
Move distance	▲
1.00mm	
JOG/MOVE	▼

↓ Press the “▽” key.

⑦ JOG/MOVE operation

The JOG/MOVE operation is possible with the “JOG+”, “JOG-“, “MOVE+” and “MOVE-“ key by displaying the “JOG/MOVE operation” in black highlight.

Current position is displayed in the third line of the screen.

“JOG+”	: Operate with the set “JOG speed” while the “JOG+” key is being pressed.
“JOG-“	: Operate in the opposite direction of “JOG+” with the set “JOG speed” while the “JOG-“ key is being pressed.
“MOVE+”	: Move the set “Move distance” from the current position with the set “JOG speed” when the “MOVE+” key is pressed once.
“MOVE-“	: Move the set “Move distance” from the current position in the opposite direction of “MOVE+” with the set “JOG speed” when the “MOVE-“ key is pressed once.

JOG	AX	1
IS.		
JOG/MOVE		
Posn	123.45mm	
“JOG/MOVE”:Move		

(5-3-1-2) JOG/MOVE items

The JOG/MOVE items are changed as follows.

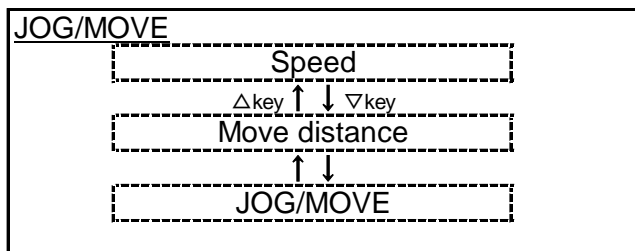

(5-3-2) “Return to origin”

- The return to origin is forcibly started.

(5-3-2-1) Return to origin screen and the operating procedure

- ① Select the item “Return to ORIG”.

Display the “Return to ORIG” in black highlight in the test selecting screen by pressing the “Δ▽” key and press the “SET” key.

Sel Test	AX	1
IS.		
JOG/MOVE	▲	
Return to ORIG		
Test drive	▼	

↓ Press the “SET” key.

② "EXT Inp OFF"

It is to confirm whether to disable the input from external equipment such as PLC to CN5 terminal of the controller.

It is necessary to disable the input from external equipment to perform "Return to ORIG" operation.

Display the "YES" in black highlight by pressing the "◀▶" key and press the "SET" key to disable the input.

Check	AX IS.	1
EXT Inp OFF		
Yes	No	
Check safety!!!		

↓ Select "Yes" and press "SET" key.

③ "Servo ON, Ready"

It is to confirm the motor power to be turned ON (servo ON).

It is confirmed only when the motor power is OFF (servo OFF).

It is possible to have "Return to ORIG" operation only when the motor power is ON.

Display the "YES" in black highlight by pressing the "◀▶" key and press the "SET" key to turn the motor power ON.

Check	AX IS.	1
Servo ON,Ready?		
Yes	No	
Status:ServoOFF		

↓ Select "Yes" and press "SET" key.

④ "Return to origin" operation

Display the "YES" in black highlight by pressing the "◀▶" key and press the "SET" key to return to origin.

When the operation of return to origin is completed, the fourth line is changed to "Completed".

When the operation of return to origin is completed once, the fourth line is displayed as "Completed".

RTN ORIG	AX IS.	1
Return to ORIG		
Yes	No	
Not at ORIG		

(5-3-3) "Test drive"

●The test drive of the optional step data is possible.

*When connecting to LECPA, the function "Test drive" cannot be used.

TB Ver2.1 or more: When connecting to LECPA, the item "Test drive" is not displayed in "Test" menu.

(5-3-3-1) Test drive screen and the operating procedure

① Select the item "Test drive"

Display the item "test drive" in the test selecting screen in black highlight with the "△▽" key.

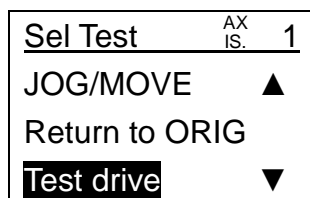

↓ Press the "SET" key.

② "EXT Inp OFF"

It is to confirm whether to disable the input from outside equipment such as PLC to CN5 terminal of the controller.

It is necessary to disable the input from outside to do "Test drive" operation.

Display the "YES" in black highlight by pressing the "◀▶" key and press the "SET" key to disable the input.

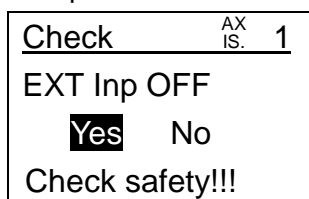

↓ Select "Yes" and press "SET" key.

③ "Servo ON, Ready"

It is to confirm the motor power to be turned ON (servo ON).

It is confirmed only when the motor power is OFF (servo OFF).

It is possible to have "Test drive" operation only when the motor power is ON.

Display the "YES" in black highlight by pressing the "◀▶" key and press the "SET" key to turn the motor power ON.

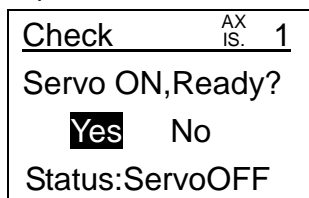

↓ Select "Yes" and press "SET" key.

④ "Return to origin"

It is to confirm whether to return to origin.

It is confirmed only when returning to origin is not executed even once after turning on the power supply of controller.

Display the "YES" in black highlight by pressing the "◀▶" key and press the "SET" key to return to origin.

RTN ORIG	AX IS.	1
Return to ORIG		
Yes No		
Not at ORIG		

↓ After return to origin is completed.

⑤ "Safety speed" setting

Whether or not speed should be restricted during test drive is set to secure safety.

Select the choices "Enable" or "Disable" with the "◀ ▶" key and set it with the "SET" key.

"Enable": Test drive speed is restricted with setting "safety speed (operation parameter)" as upper limit.
 "Disable": Test drive is executed with step data set speed.

Test DRV	AX IS.	1
Safety speed	▲	
◀ Disable ▶		
Test step No.	▼	

↓ Press the "▽" key.

⑥ Test drive step data setting

Step data No. for the test drive is set.

When step data is not set, select "None" and set it with the "SET" key.

When step data is set, change "None" to numbers with the "◀ ▶" key. Then input the step data No. with number keys and set it with the "SET" key.

It is possible to set the step data from 1st to 5th.

When test drive is executed, the operation is tested by the step data in a number order from No.1 to 5.

Test DRV	AX IS.	1
1st	▲	
◀ None ▶		
2nd	▼	

↓ Press the "◀ ▶" key.

Test DRV	AX IS.	1
1st	▲	
0		
2nd	▼	

Input No. of step data for testing.

↓ Press the "▽" key several times.

⑦ Setting of test cycle

Set cycles of test drive to “1” or “Continuous”.

1st to 5th step data that set in ⑥ is 1 cycle.

Select the choices “1” or “Continuous” with the “◀▶” key and set it with the “SET” key.

“1” : Operate only one cycle and stop the operation.
 “Continuous” : Operate with continuous cycles.

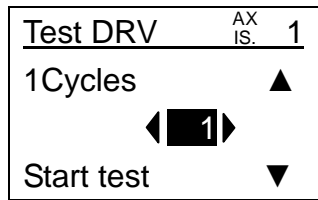

↓ Press the “SET” key.

⑧ Test drive start

When displaying “Start test” in black highlight and pressing the “SET” key, the test drive is started.

However, note that if all of the test step data is set as “None” in ⑥, the item “test drive start” is not displayed in black highlight and the test drive can’t start.

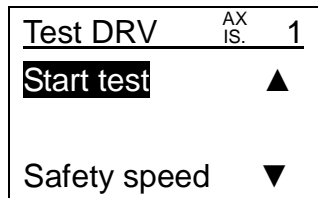

↓ Press the “SET” key.

“Stop” is displayed in black highlight during the test drive.

When the “SET” key is pressed, the test drive is cancelled.

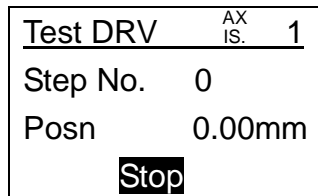

↓ Press the “SET” key.

When the test drive is cancelled or when one cycle is completed, the screen is changed to the one stated below and “Return” is displayed in black highlight.

When pressing the “SET” key, the screen is returned to the test drive set screen.

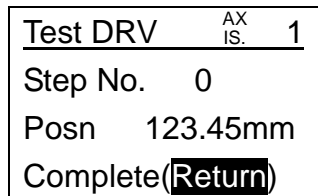

(5-3-4) "Force output"

- Optional output terminals of the controller can be turned ON or OFF forcibly by terminal No. or signal name.

(5-3-4-1) Force output selecting screen

Item to be selected are changed with the "Δ▽" key.

The selected items are shown in black highlight.

The item that is selected by the "SET" key can be forcibly output.

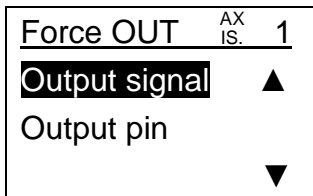

(5-3-4-2) Force output items

Force output items are changed as follow.

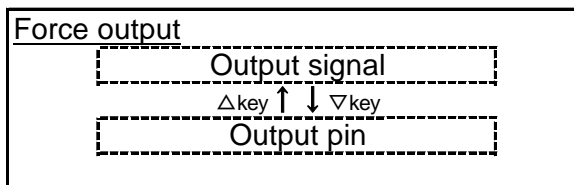

(5-3-4-3) Force output details.

(a) Output signal

- Optional output terminals of the controller can be turned ON or OFF forcibly by signal name.

* Right after the item "Output signal" is selected and the "SET" key is pressed, the output signal remains the status when the "SET" key is pressed. Then forcible ON and OFF is available.
Note that even though the signal is forcibly turned ON/OFF, it doesn't affect the controller.

(a-1) Output signal screen and the operating procedure

- ① Select the item "Output signal".

Display the item "Output signal" in the force output selecting screen by pressing the "Δ▽" key and press the "SET" key.

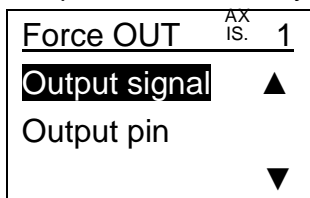

↓ Press the "SET" key.

②How to output the signal forcibly.

Display the output signal that needs to be forcibly turned ON and OFF in black highlight by pressing the “△▽” key and press the “SET” key.

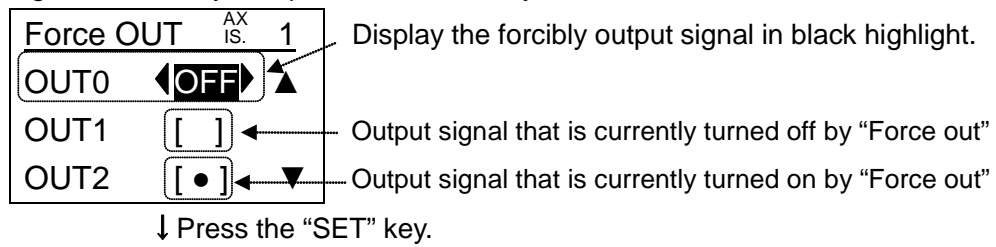

Select the required output between “ON” and “OFF” with the “◀▶” key and press the “SET” key. The signal or terminal status just before the forcible output was executed is displayed in the meantime.

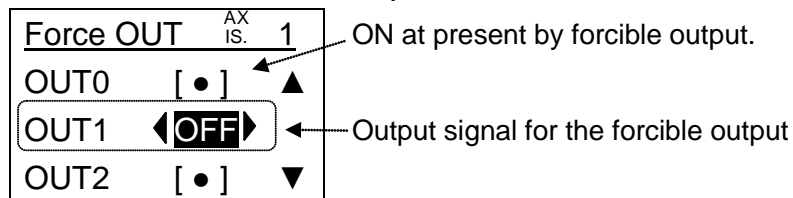
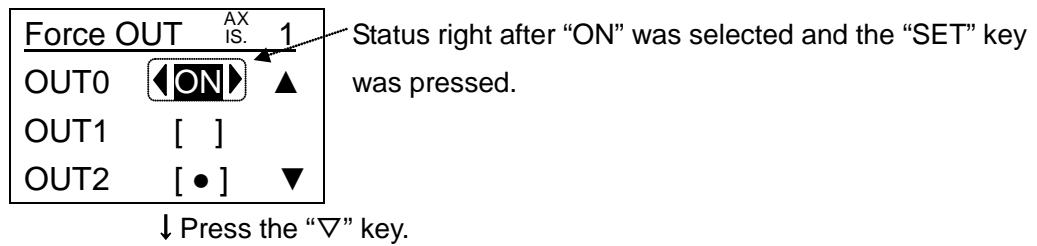

(a-2) Output signal items

Test items are changed as follows.

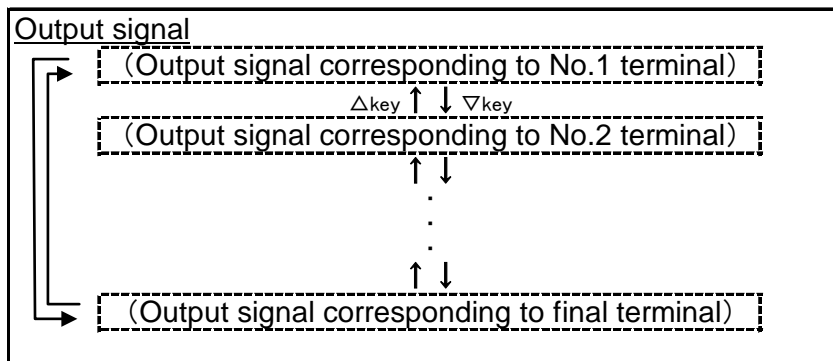

(b) Output pin

- It is possible to forcibly control output pin on and off the optional controller output pin by pin number.

* Right after the item “Output pin” is selected and the “SET” key is pressed, the output terminal remains the status when the “SET” key is pressed. Then forcible ON and OFF is available. Note that even though the terminal is forcibly turned ON/OFF, it doesn't affect the controller.

(b-1) Output pin screen and the operating procedure

① Select the item "Output pin".

Display "Output pin" in the "Force output" selecting screen in black highlight with the "Δ▽" key and press the "SET" key.

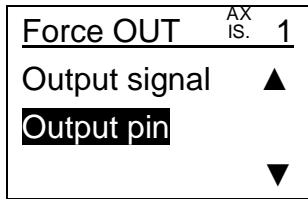

↓ Press the "SET" key.

② How to output the pin (terminal) forcibly.

Display the output pin No. that needs to be forcibly turned ON or OFF in black highlight with the "Δ▽" key and press the "SET" key.

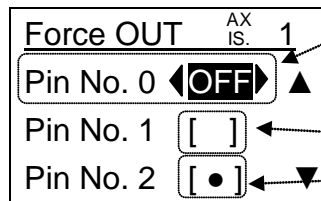

Display the pin No. that forcibly output.

Output pin that is currently turned OFF by "Force output"

Output pin that is currently turned ON by "Force output"

↓ Press the "SET" key.

Select the required output between "ON" and "OFF" with the "◀▶" key and press the "SET" key. The signal or terminal status just before the forcible output was executed is displayed in the meantime.

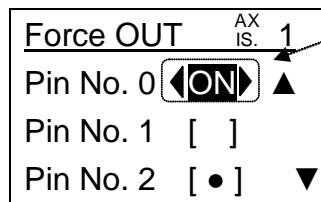

Status right after "ON" was selected and the "SET" key was pressed.

↓ Press the "▽" key.

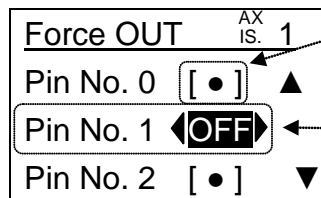

ON at present by "Force output".

Output pin for the forcible output

(b-2) Output pin items

The test items are changed as follows.

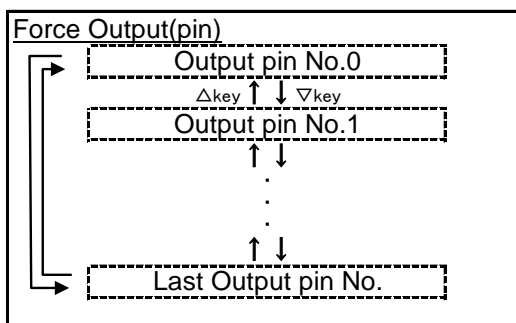

(6) Normal mode “Monitor”

- The status of “Drive”, “Output signal”, “Input signal”, “Output pin” and “Input pin” can be monitored.
- TB Ver2.1* or more: When connecting to LECPA, “Input pulse” can be monitored in “Drive” status.

(6-1) Monitor selecting screen

The items to be selected are changed with the “Δ▽” key.
 The selected item is shown in black highlight.
 The selected item can be monitored by pressing the “SET” key.

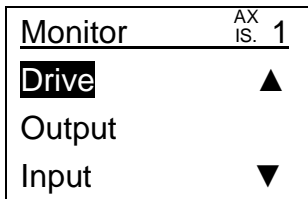

(6-2) Monitor items

The monitor items are changed as follows.

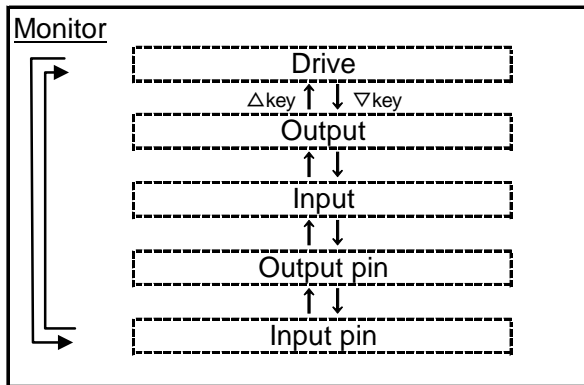

(6-3) Monitor details

(6-3-1) “Drive” monitor

- Items related to the actuator drive such as “Position”, “Speed”, “Pushing force” and others can be monitored.
- TB Ver2.1* or more: When connecting to LECPA, “Input pulse” can be monitored in “Drive” status.
- TB Ver2.1* or more: When connecting to LECPA, “Position” and “Speed” also by the unit of “pulse” and “pulse/sec ” can be monitored.

(6-3-1-1) Drive monitoring screen and the operating procedure

① Select the “Drive” monitor

Display the item “Drive” in the monitor selecting screen in black highlight with the “Δ▽” key and press the “SET” key.

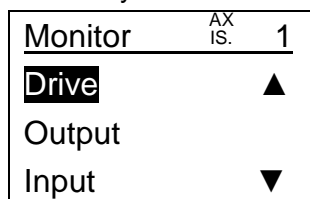

↓ Press the “SET” key.

②How to monitor

Display the items to be monitored with the “△▽” key.

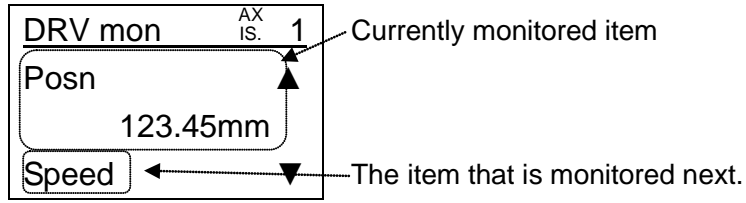

(6-3-1-2) Drive monitoring items

The drive monitoring items are changed as follows.

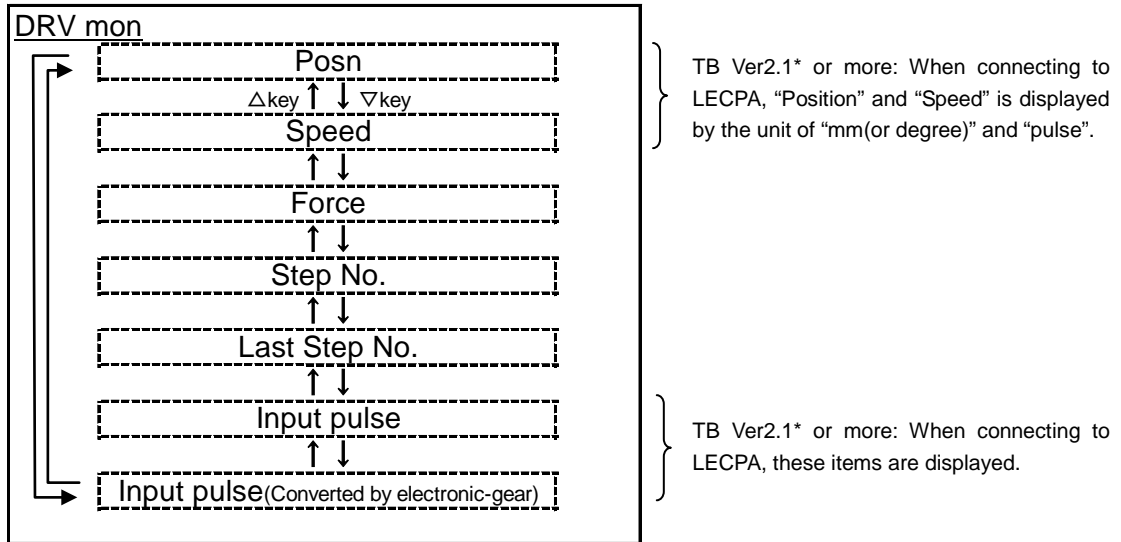

(6-3-2) "Output" monitor

●TB Ver1.**:

Output signal such as "BUSY" and "SVRE" and items "Serial No.", "Type No." and "Version" can be monitored.

●TB Ver2.**:

Output signal such as "BUSY" and "SVRE" and items "Serial No.", "Unit name" and "Version" can be monitored.

*Refer to "5.1 (1)" to confirm TB Ver.

(6-3-2-1) Output signal monitoring screen and the operating procedure

①Select "Output" from the monitor selecting screen.

Display the item "Output" in the monitor selecting screen in black highlight with the "Δ▽" key and press the "SET" key.

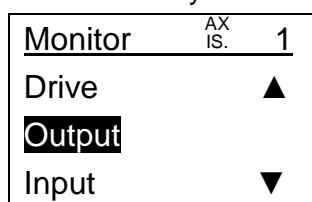

↓ Press the "SET" key.

②How to monitor

When the output signal is being monitored :

Display the output signal that needs to be monitored with the "Δ▽" key.

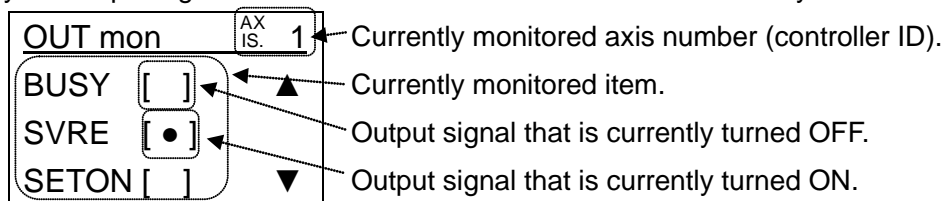

↓ Press the "Δ▽" key several times.

When "Serial No.", "Type No.(TB Ver1.**)" or "Unit name(TB Ver2.**)" and "Version" are being monitored :

Display the item to be monitored with the "Δ▽" key.

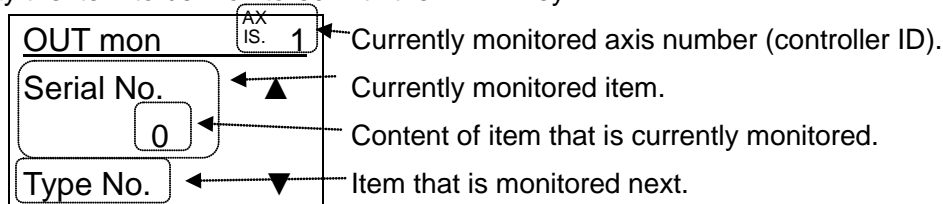

(6-3-2-2) Output signal monitor items

The output signal monitoring items are changed as follows.

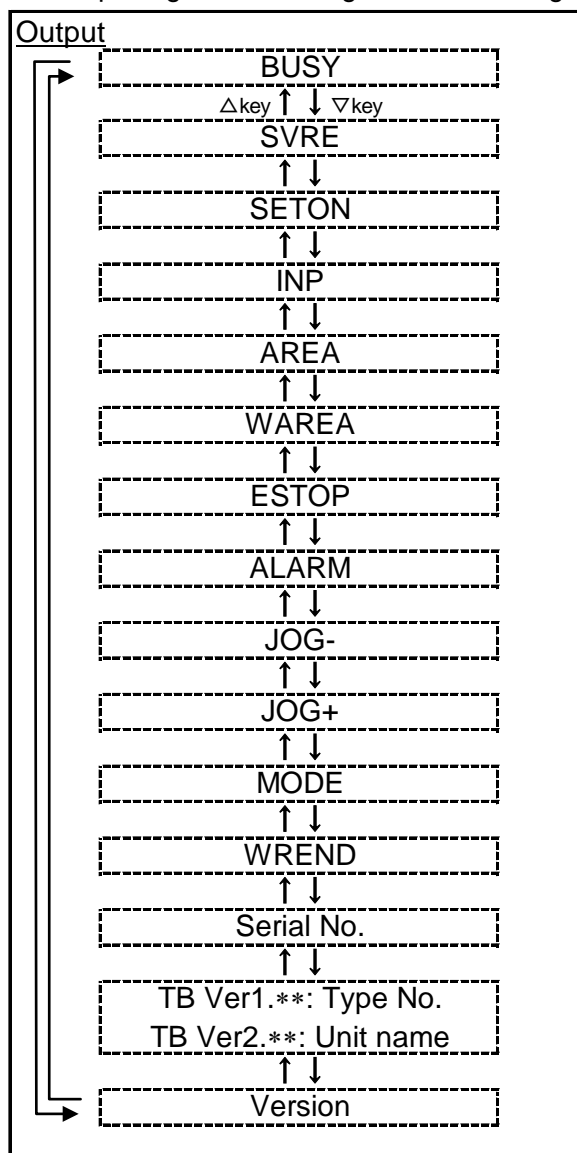

*Parallel I/O only in connecting controller can be monitored. In Output signal monitor items, the signal that is not in connecting controller is displayed but cannot be monitored.

(6-3-3) "Input" monitor

● It is possible to monitor input signal items such as "HOLD", "SVON" and "DRIVE".

(6-3-3-1) Input signal monitor screen and the operating procedure

① "Input" selection.

Display the "Input" in the monitor selecting screen in black highlight with the "Δ▽" key and press the "SET" key.

Monitor	AX IS.	1
Drive		▲
Output		
Input		▼

↓ Press the "SET" key.

②How to monitor

Display the output signal that needs to be monitored with the “△▽” key.

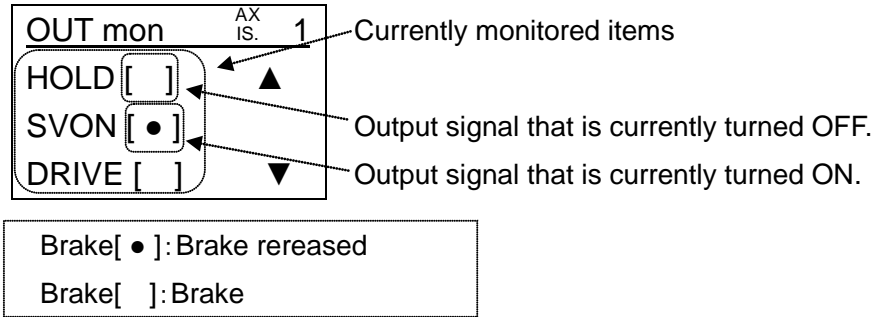

(6-3-1-2) Input signal monitoring item

The input signal monitoring items are changed as follows.

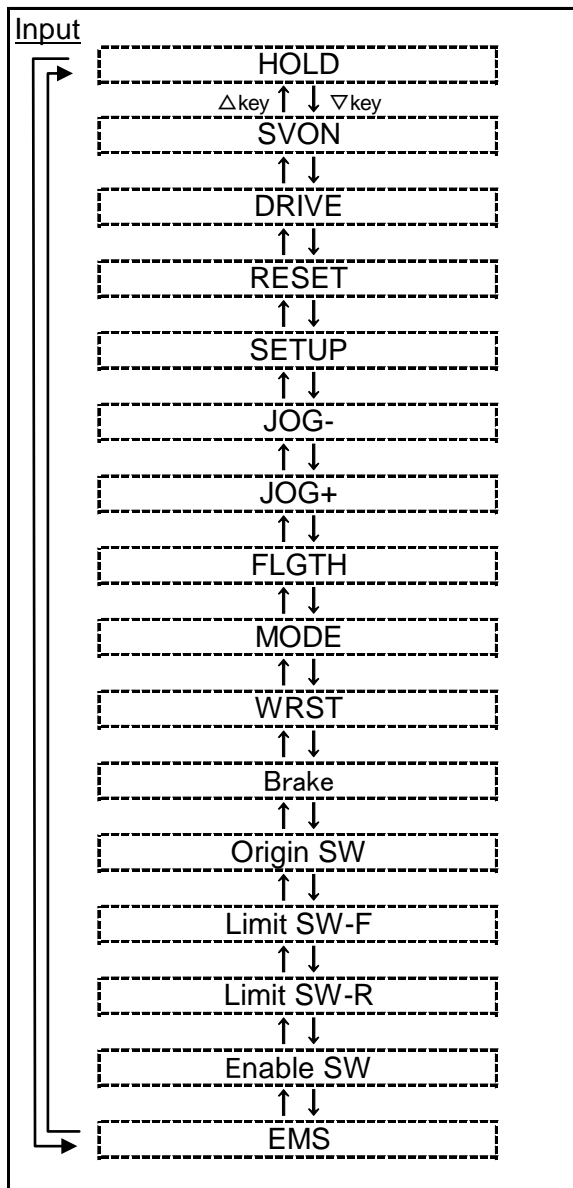

*Parallel I/O only in connecting controller can be monitored. In loutput signal monitor items, the signal that is not in connecting controller is displayed but cannot be monitored.

Origin SW: Origin switch
Limit SW-F: Limit switch F side
Limit SW-R: Limit switch R side
EMS: Stop (Normal close)
 { EMS [] → Stop
 { EMS [●] → Stop cancelled

(6-3-4) “Output pin” monitor

- It is possible to monitor the output pin of the controller with the pin number.

(6-3-4-1) Output pin monitoring screen and the operating procedure

① “Output pin” selection.

Display the “Output pin” in the monitor selecting screen in black highlight with the “Δ▽” key and press the “SET” key.

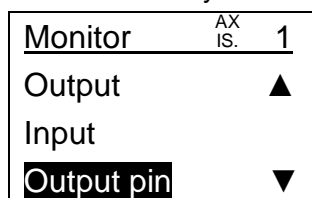

↓ Press the “SET” key.

② How to monitor

Display the output signal that needs to be monitored with the “Δ▽” key.

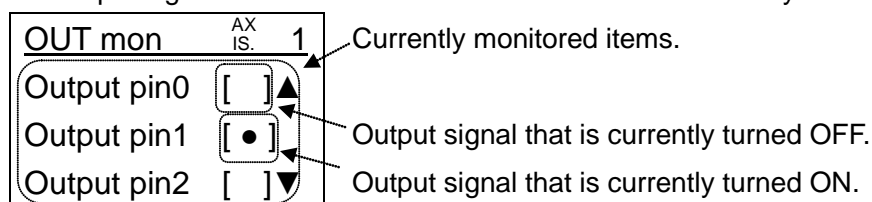

(6-3-4-2) Output pin monitoring items.

The output pin monitoring items are changed as follows.

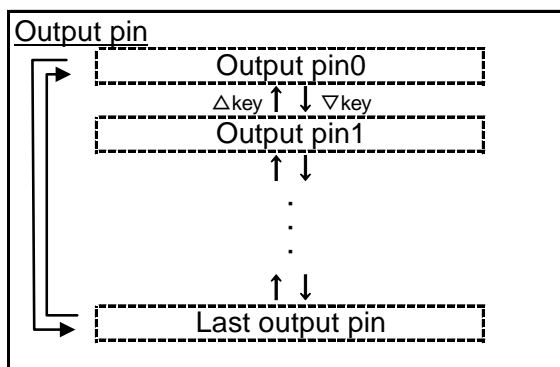

Displayed item name in teaching box	Connected controller's corresponded CN5 pin No.	
	LECP,LECA	LECPA
Output pin0	B1	12
Output pin1	B2	13
Output pin2	B3	14
Output pin3	B4	15
Output pin4	B5	16
Output pin5	B6	17
Output pin6	B7	18
Output pin7	B8	19
Output pin8	B9	20
Output pin9	B10	–
Output pin10	B11	–
Output pin11	B12	–
Output pin12	B13	–

(6-3-5) “Input pin” monitor

- It is possible to monitor the input pin of the controller with the pin number.

(6-3-5-1) Input pin monitoring screen and the operating procedure

① “Input pin” selection

Display the “Input pin” in the monitor selecting screen in black highlight with the “Δ▽” key and press the “SET” key.

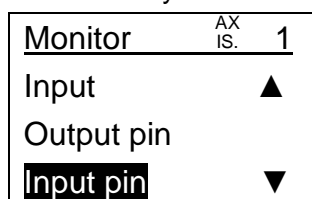

↓ Press the “SET” key.

②How to monitor

Display the input signal that needs to be monitored with the “△▽” key.

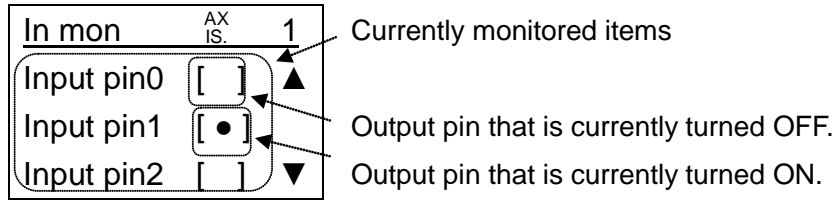

(6-3-5-2) Input pin monitoring item

The inputpin monitoring items are changed as follows.

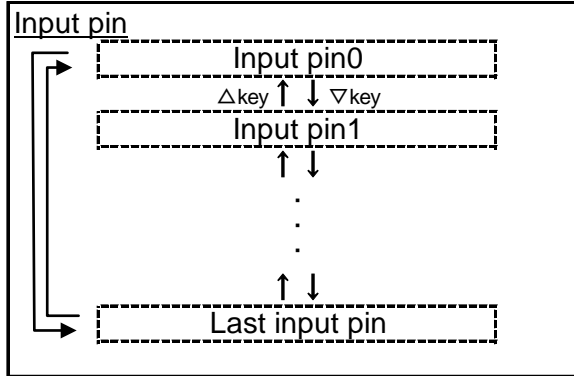

Displayed item name in teaching box	Connected controller's corresponded CN5 pin No.	
	LECP,LECA	LECPA
Input pin0	A3	7
Input pin1	A4	8
Input pin2	A5	9
Input pin3	A6	10
Input pin4	A7	-
Input pin5	A8	-
Input pin6	A9	11
Input pin7	A10	-
Input pin8	A11	-
Input pin9	A12	-
Input pin10	A13	-

(7) Normal mode “Alarm”

● It is possible to check and reset the current alarms and also possible to check the past alarms.

(7-1) Alarm selecting screen

The items to be selected are changed with the “△▽” key.

The selected item is shown in black highlight.

The selected item can be executed with the “SET” key.

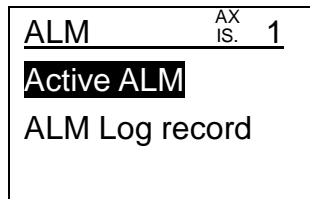

(7-2) Alarm selecting items

The alarm selecting items are changed as follows.

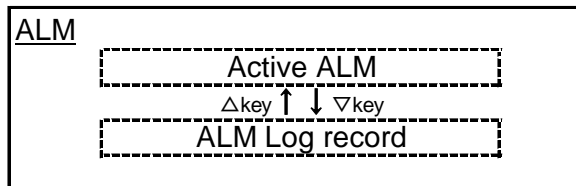

(7-3) Alarm function details

(7-3-1) "Active ALM"

- It is possible to check and reset the current alarms.
- When an alarm is generated, it will be displayed automatically.

(7-3-1-1) Active alarm screen and how to reset the alarm

① "Active ALM" selection

Display the "Active alarm" in the alarm selecting screen in black highlight with the "△▽" key and press the "SET" key.

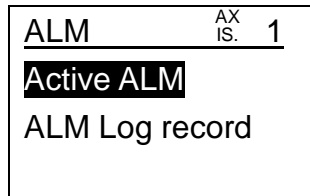

↓ Press the "SET" key.

② Check of the active alarm that is attributed to the connected controller

In the active alarm selection, no alarm is displayed on the screen when the alarm that is attributed to the connected controller is not generated.

When four or more of alarms are generated, the fourth or later alarms can be checked with the "△▽" key.

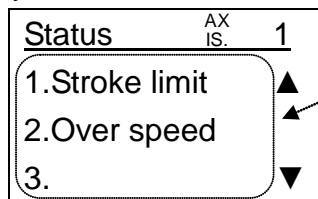

Currently generated alarm (up to 8 alarms)

↓ Press the "SET" key or "△▽" key several times.

③ Alarm reset

When alarms are generated, it is possible to reset them on this screen.

Select "Yes" with the "◀▶" key and press the "SET" key to reset alarm.

Note that depending on the alarm types, the cause of the alarm should be eliminated and the power supply of the controller needs to be applied to cancel the alarm.

In that case, even though the alarm is reset, the alarm remains on the screen and also the controller keeps its alarm status.

Refer to "Controller operation manual" for the detailed alarm types.

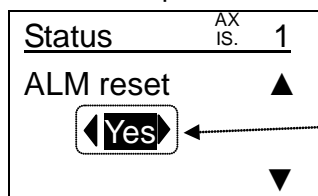

Select "Yes" and press the "SET" key to reset the alarm.
(*Some alarms cannot be reset on this screen.)

(7-3-1-3) Active alarm items

The active alarm items are changed as follows.

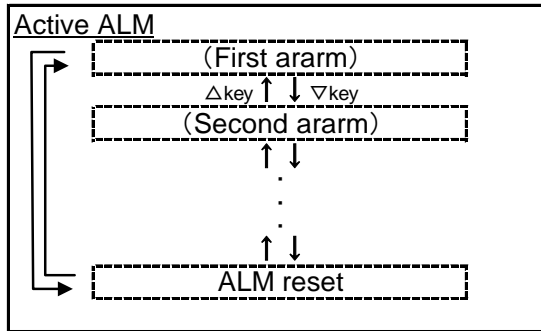

(7-3-2) ALM log record

● It is possible to check the past alarms.

* The alarm that is specific to the teaching box (TB alarm) is not left in the record.

(7-3-2-1) Alarm log record screen and the operating procedure

① Select the item “ALM log record”.

Display the “ALM log revcord” in the alarm selecting screen in black highlight with the “Δ▽” key and press the “SET” key.

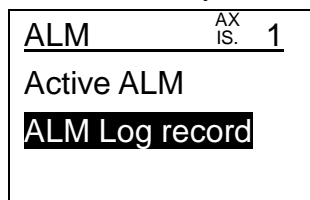

↓ Press the “SET” key.

② Alarm log selection

Select the number of the alarm logs (where 1 is the most recent alarm logs, 2 is the next most recent, and so on) with the “◀▶” key and press the “SET” key.

It is possible to go back to the 8th alarm logs before.

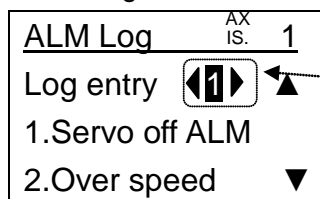

Select the number of the alarm that was generated in the past with the “◀▶” key and press the “SET” key. (up to the 8th alarm logs before can be set.)

↓ Press the “▽” key.

③ Past alarms check

If three or more of alarms occur, the third or later alarms can be checked with the “Δ▽” key.

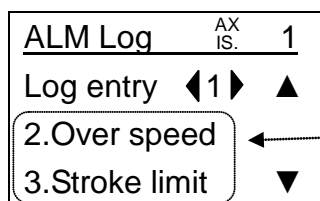

Alarm that occurred last time.

(7-3-2-2) Alarm record items

The alarm record items are changed as follows.

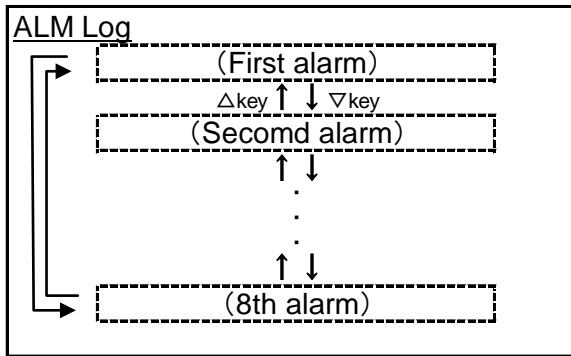

(7-3-3) TB alarm screen and how to reset the alarm

When the alarm that is specific to the teaching box is generated, the screen “TB ALM” is displayed automatically.

①Active alarm check

When TB alarms are generated, TB alarm is displayed on the screen automatically.

When four or more of alarms are generated, fourth or later alarms can be checked with “Δ▽” key.

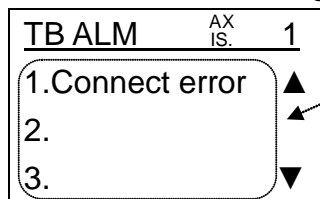

Currently generated alarm (up to 8 letters)

↓ Press the “SET” key or “Δ▽” key several times.

②Alarm reset

When alarms are generated, it is possible to reset them on this screen.

Select “Yes” with the “◀▶” key and press the “SET” key to reset alarm.

Note that depending on the alarm types, the cause of the alarm should be eliminated and the power supply of the controller needs to be applied to cancel the alarm.

In that case, even though the alarm is reset, the alarm remains on the screen and also the controller keeps its alarm status.

Refer to “8. Troubleshooting” for the detailed alarm types.

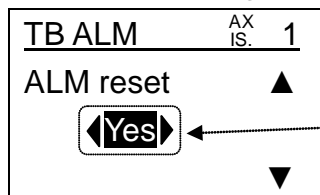

Select “Yes” and press the “SET” key to reset the alarm.
(*Some alarms cannot be reset on this screen.)

(8) Normal mode “File”

- Data can be composed as one file by reading it from the controller and it is possible to save four files in the teaching box at maximum.

* Data is read from the controller with which the teaching box is communicating and saved in the teaching box.

- The files that are saved in the teaching box can be transferred to the controller by selecting it as “Step data” or “Parameter” only or “all”.
- The files that are saved in the teaching box can be deleted.
- Even though several controllers are connected, files can be saved and transferred to the specified controller from one teaching box.
- TB Ver2.**, the files that are saved in the teaching box can be protected from overwriting, the deletion and changing of the file name. (TB Ver1.**, the saved file cannot be protected.)

*Refer to “5.1 (1)” to confirm TB Ver.

(8-1) File items screen

The items to be selected are changed with the “ $\Delta \nabla$ ” key.

The selected item is shown in black highlight.

The selected item can be executed with the “SET” key.

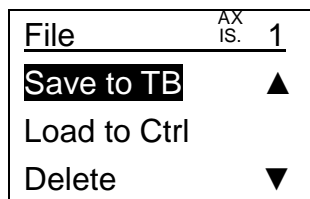

(8-2) File items

The file items are changed as follows.

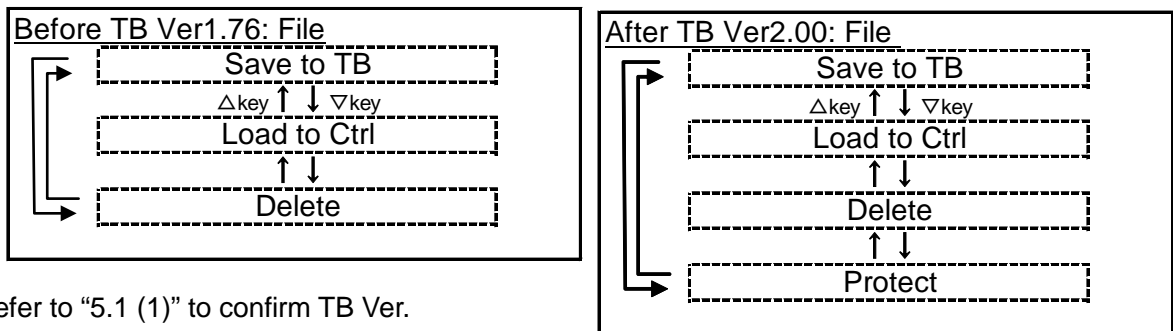

*Refer to “5.1 (1)” to confirm TB Ver.

(8-3) File function details

(8-3-1) “Save to TB”

- Compose one file by reading out step data and parameters from the controller and it is possible to save four files in the teaching box at maximum.

* Data is read out from the controller with which the teaching box is communicating and saved in the teaching box.

- The file name of the data file that is saved to the teaching box can be changed.
- Even though controllers are connected, data can be read out from the specified controller with one teaching box and it can be saved to the teaching box.

(8-3-1-1) "Save to TB" screen and the operating procedure

(a) Save to TB

(a-1) TB Ver1.**

*Refer to "5.1 (1)" to confirm TB Ver.

① Check of the currently accessed axis (controller ID) number.

Check that the number (controller ID) of the currently accessed axis (controller) is correct.

* In the following case, the data is being read from the axis 1 (controller whose ID is "1".) and saved to the teaching box.
 * The axis number is identical to the basic parameter of the controller "controller ID" (Refer to the "Controller operation manual").
 * Refer to "6.4 (1) Axis change" when changing the axis.

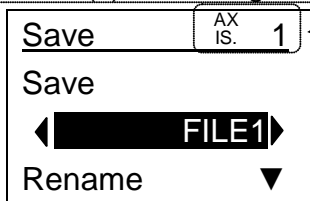

Check the number (controller ID) of the axis (controller) to where data is read from teaching box.

↓ When the axis number (controller ID) of currently accessed axis (controller) is correct.

② Selection of Save to TB file

Select the file to where the data from the controller is saved with the "◀▶" key and press the "SET" key.

It is possible to save four files at maximum.

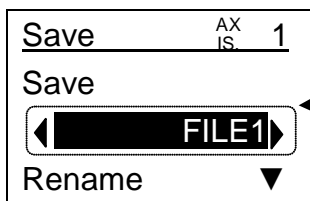

Select the file with the "◀▶" key and press the "SET" key.

↓ Press the "SET" key."

③ "Save" execution check

Check that saving the data from controller to teaching box is executed.

Display "Yes" in black highlight and press the "SET" key to save the controller data.

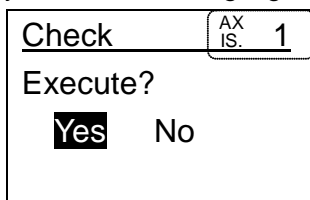

Check the currently accessed axis (controller ID) to where data is read from teaching box.

↓ Select "Yes" and press the "SET" key.

④ Save to TB

While data is being saved, the display "In progress..." is displayed in the fourth line of the screen.

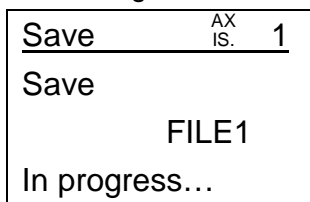

↓ After Save to TB is completed.

⑤ Saving completed

Once the Save to TB is completed, "Completed" is displayed in the fourth line of the screen.

When the "SET" key is pressed, the screen goes back to item ① screen.

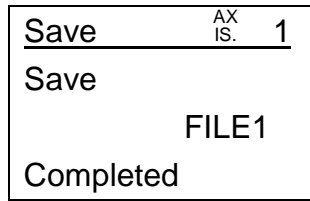

↓ Press the "SET" key.

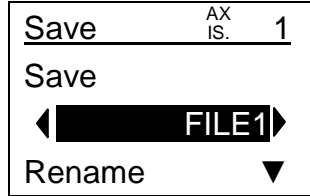

(a-2) TB Ver2.**

*Refer to "5.1 (1)" to confirm TB Ver.

① Check of the currently accessed axis (controller ID) number.

Check that the number (controller ID) of the currently accessed axis (controller) is correct.

- * In the following case, the data is being read from the axis 1 (controller whose ID is "1".) and saved to the teaching box.
- * The axis number is identical to the basic parameter of the controller "controller ID" (Refer to the "Controller operation manual").
- * Refer to "6.4 (1) Axis change" when changing the axis.

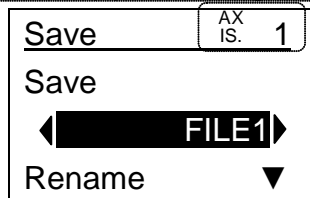

Check the number (controller ID) of the axis (controller) to where data is read from teaching box.

↓ When the axis number (controller ID) of currently accessed axis (controller) is correct.

② Selection of Save to TB file

Select the file to where the data from the controller is saved with the "◀▶" key and press the "SET" key.

It is possible to save four files at maximum.

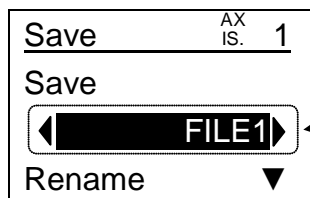

Select the file with the "◀▶" key and press the "SET" key.

↓ Press the "SET" key."

* When the file that is protected in the "Protect" function is selected and the "SET" key is pressed, "Protected file" is displayed on the filename and the data cannot be saved to the file.
 Select the file that is not protected or reset the protection of the file in the "Protect" function.

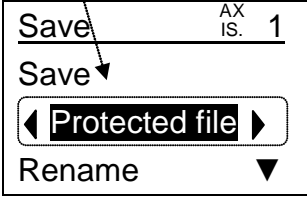

Select the file with the "◀ ▶" key and press the "SET" key.

③ Save file check

When the data is saved to the file, it checks the file which is overwritten.

After it checked the file which is over written, press the "SET" key.

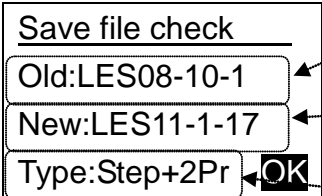

The setting content of "Basic/Unit name" in the file that is overwritten (the file that was saved in the teaching box).
 The setting content of "Basic / Unit name" of the connected controller.
 The setting content of "Basic / Para protect" of the connected controller. (Refer to the table below)

Table a.1 Details of the content displayed in "Type"

Type	Registered value of "Para protect" of the connected controller	Content
Step+2Pr	1	Step data, Basic and ORIG parameter can be set.
2Pr only	2	Only Basic and ORIG parameter can be set.

↓ Press the "SET" key."

④ "Save" execution check

Check that saving the data from controller to teaching box is executed.

Display "Yes" in black highlight and press the "SET" key to save the controller data.

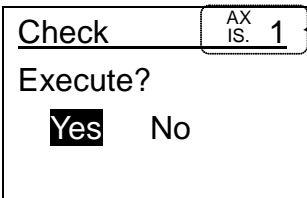

Check the currently accessed axis (controller ID) .
to where data is read from teaching box.

↓ Select "Yes" and press the "SET" key.

⑤ Save to TB

While data is being saved, the display "In progress..." is displayed in the fourth line of the screen.

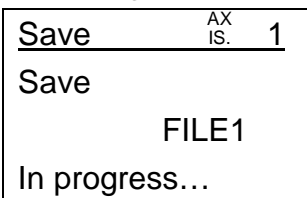

↓ After Save to TB is completed.

⑥ Saving completed

Once the Save to TB is completed, "Completed" is displayed in the fourth line of the screen.

When the "SET" key is pressed, the screen goes back to item ① screen.

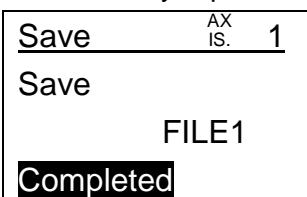

↓ Press the “SET” key.

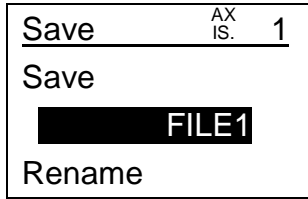

(b) File name change

① Select the item “Rename”.

Display “Save to TB” in the file item in black highlight and press the “SET” key.

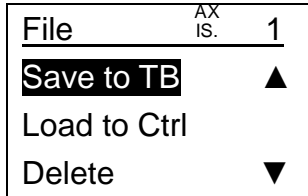

↓ Press the “SET” key.

Select the file whose file name is changed with the “◀ ▶” key (Do not press the “SET” key).

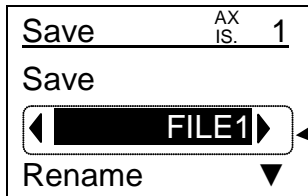

← Select the file with the “◀ ▶” key.

Do not press the “SET” key.

↓ Press the “▽” key.

Display “Rename” in black highlight and press the “SET” key.

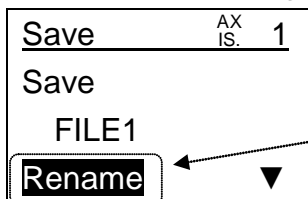

← Display in black highlight and press the “SET” key.

↓ Press the “SET” key.

*TB Ver2.**, when the file that is protected in the "Protect" function is selected and the "SET" key is pressed, "Protected file" is displayed on the filename and the filename cannot be changed. (Refer to the figure below)

Select the file that is not protected or change the protected file to the non-protected file in the "Protect" function.

(TB ver1.**, the display in the figure below does not appear because the “Protect” function is not included.)

*Refer to “5.1 (1)” to confirm TB Ver.

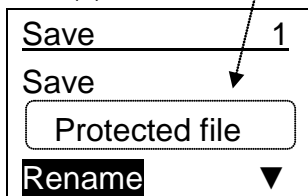

② Rename

The cursor appears under the last character of the file name and characters can be entered. Refer to “1.1 (2) ⑭ Number (character) keys” for how to enter characters.

When the “SET” key is pressed, the input file name is saved and the screen goes back to item ①.

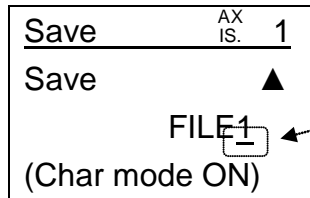

Cursor

Press the “SET” key after entering characters.

↓ Press the “SET” key.

“Save to TB” and “Rename” are completed.

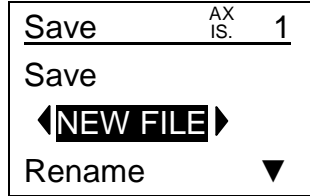

(8-3-1-2) “Save to TB” items

The “Save to TB” items are changed as follows.

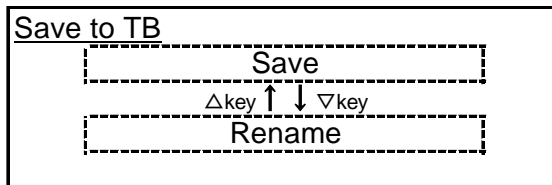

(8-3-2) “Load to Ctrl”

- It is possible to transfer the file that is saved to the teaching box to the controller by selecting it from “Step data” or “Parameter” only or “All” (step data and parameter).
- Even though several controllers are connected, “Step data” or “Parameter” can be load to the specified controller from one teaching box. With this function, the same “Step data” or “Parameter” can be copied to other controllers.

(8-3-2-1) “Load to Ctrl” screen and the operating procedure

(a) TB Ver1.**

*Refer to "5.1(1)" to confirm TB Ver.

① Check of the file loaded axis number (controller ID).

Check that the axis number (controller ID) to where file data is loaded and registered is correct.

- * In the following case, the file data is loaded to the axis 1 (controller whose ID is “1”).
- * The axis number is identical to the basic parameter of the controller “controller ID” (Refer to the “Controller operation manual”).
- * Refer to “6.4 (1) Axis change” when changing the axis.

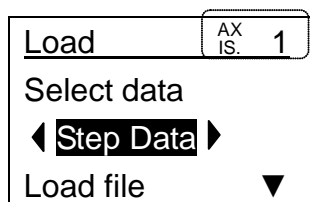

Check that the axis number (controller ID) to where file data is loaded.

↓ When the number of file loaded axis (controller ID) is correct.

② Selection of the load data

Select the load data with the “◀▶” key and press the “SET” key.

When “Step data” is selected: Only step data is loaded to the controller from the save file.
When “Parameter” is selected: Only parameters are loaded to the controller from the save file.
When “All” is selected: All data (step data and parameters) in the save file is loaded to the controller.

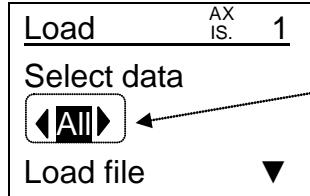

Select the load data with the “◀▶” key and press the “SET” key.

↓ Select the load file, press the “SET” key and then the “▽” key.

③ Selection of load file

Select the load file with the “◀▶” key and press the “SET” key.

If the model of the transferred file and that of the controller to where the file is transferred is different, the file data cannot be transferred.

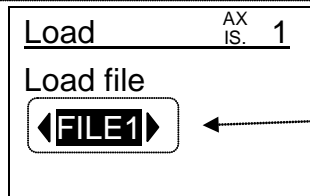

Select the transferred file with the “◀▶” key and press the “SET” key.

↓ Press the “SET” key.

④ “Load file” execution check

Check that loading the file from teaching box to controller is executed.

Display “Yes” in black highlight and press the “SET” key to transfer the file.

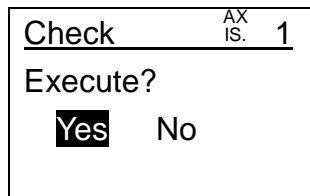

↓ Select “Yes” and press the “SET” key.

⑤ “EXT Inp OFF”

It is to confirm whether to disable the input from external equipment such as PLC to CN5 terminal of the controller.

It is necessary to disable the input from external equipment to do “Load to Ctrl” operation.

Display the “YES” in black highlight by pressing the “◀▶” key and press the “SET” key to disable the input.

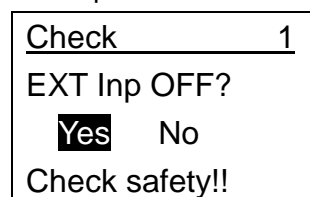

↓ Select “Yes” and press the “SET” key.

⑥ Load file

While the file is being transferred, the message “Load file...” is displayed in the fourth line of the screen.

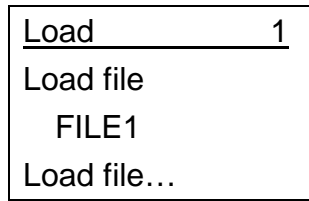

↓ After file loading is completed.

⑦ “EXT Inp ON”

To confirm whether to enable the input from outside equipment such as PLC to CN5 terminal of the controller.

The actuator operates according to the input from external equipment such as PLC when the input from external equipment is enabled.

Press the “SET” key after checking that safety is well secured.

⚠ Warning
Confirm safety when recovering of input before pressing the SET key to determine “OK”. The actuator may operate suddenly when the input from external equipment such as PLC is recovered.

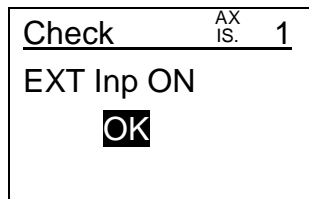

↓ After Checking safety, press the “SET” key.

⑧ File loading is completed

Once the file loading is completed, the display “Completed” is displayed in the fourth line of the screen.

When the “SET” key is pressed, the screen goes back to item ① screen.

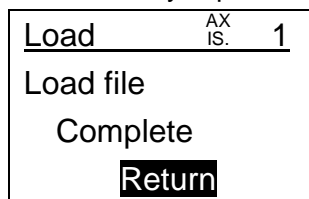

↓ Press the “SET” key.

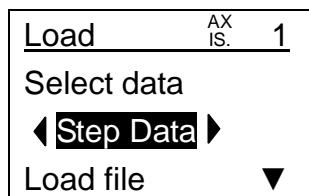

(b) TB Ver2.**

*Refer to "5.1(1)" to confirm TB Ver.

①Check of the file loaded axis number (controller ID).

Check that the axis number (controller ID) to where file data is loaded and registered is correct.

* In the following case, the file data is loaded to the axis 1 (controller whose ID is "1").

* The axis number is identical to the basic parameter of the controller "controller ID" (Refer to the "Controller operation manual").

* Refer to "6.4 (1) Axis change" when changing the axis.

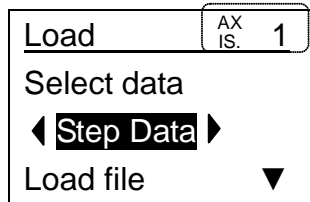

Check that the axis number (controller ID) to where file data is loaded.

↓ When the number of file loaded axis (controller ID) is correct.

② Selection of the load data

Select the load data with the “◀▶” key and press the “SET” key.

When “Step data” is selected : Only step data is loaded to the controller from the save file.
 When “Parameter” is selected : Only parameters are loaded to the controller from the save file
 When “All” is selected : All data (step data and parameters) in the save file is loaded to the controller.

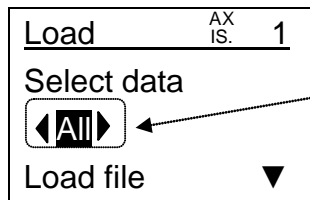

Select the load data with the “◀▶” key and press the “SET” key.

↓ Select the load file, press the “SET” key and then the “▽” key.

③ Selection of load file

Select the load file with the “◀▶” key and press the “SET” key.

If the model of the transferred file and that of the controller to where the file is transferred is different, the file data cannot be transferred.

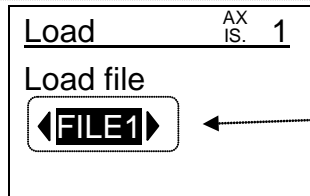

Select the transferred file with the “◀▶” key and press the “SET” key.

↓ Press the “SET” key.

④ Load file check

When the file is loaded to the controller, it checks the file which is loaded.

After it checked the file which is loaded, press the “SET” key.

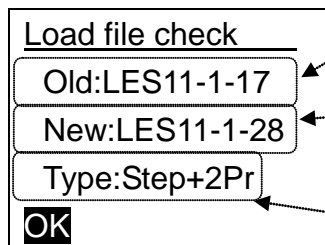

The setting content of “Basic / Unit name” of the connected controller.

The setting content of “Basic / Unit name” in the file that is loaded (the file that was saved in the teaching box).

The setting content of “Basic / Para protect” in the file that is loaded (the file that was saved in the teaching box). (Refer to the table below.)

Table b.1 Details of the content displayed in "Type"

Type	The set value of "Para protect" in the loaded file	Content
Step +2Pr	1	Step data, Basic and ORIG parameter can be set.
2Pr only	2	Only Basic and ORIG parameter can be set.

↓ Press the “SET” key.

* If the "Caution!" is displayed on the screen, the data of the file is not be loaded because the "Para protect" setting is working.

To load the file, set "Basic / Para protect" of the connected controller so that the following condition is "YES".

Table b.2 Condition that the file can be loaded

The caution screen, when the file cannot be loaded.

Type	"Select data"	Registered value of "Para protect" of the connected controller	Loading Yes/No
Step +2Pr	Step data	1	Yes
		2	No
	Parameter	1	Yes
		2	Yes
	All	1	Yes
		2	No
2Pr only	Step data	1	Yes
		2	No
	Parameter	1	Yes
		2	Yes
	All	1	Yes
		2	No

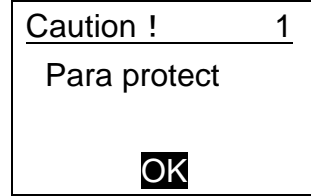

*After loading, the registered value of "Para protect" in the connected controller is set to"1", and Step data, Basic and ORIG parameter can be set.

*After loading, the registered value of "Para protect" in the connected controller is set to"2", and only Basic and ORIG parameter can be set.

④ "Load file" execution check

Check that loading the file from teaching box to controller is executed.

Display "Yes" in black highlight and press the "SET" key to transfer the file.

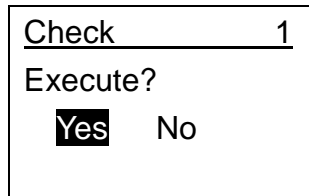

↓ Select "Yes" and press the "SET" key.

⑤ "EXT Inp OFF"

It is to confirm whether to disable the input from external equipment such as PLC to CN5 terminal of the controller.

It is necessary to disable the input from external equipment to do "Load to Ctrl" operation.

Display the "YES" in black highlight by pressing the "◁▷" key and press the "SET" key to disable the input.

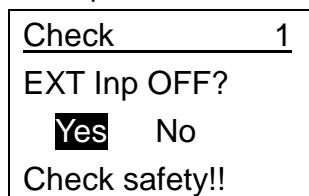

↓ Select "Yes" and press the "SET" key.

⑥ Load file

While the file is being transferred, the message “Load file...” is displayed in the fourth line of the screen.

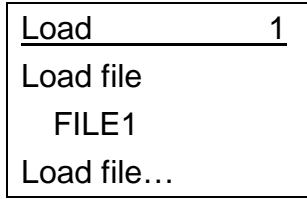

↓ After file loading is completed.

⑦ “EXT Inp ON”

To confirm whether to enable the input from outside equipment such as PLC to CN5 terminal of the controller.

The actuator operates according to the input from external equipment such as PLC when the input from external equipment is enabled.

Press the “SET” key after checking that safety is well secured.

⚠ Warning

Confirm safety when recovering of input before pressing the SET key to determine “OK”.
The actuator may operate suddenly when the input from external equipment such as PLC is recovered.

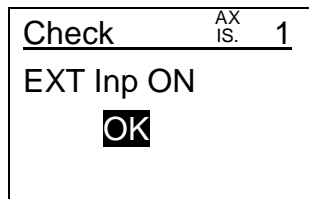

↓ After Checking safety, press the “SET” key.

⑧ File loading is completed

Once the file loading is completed, the display “Completed” is displayed in the fourth line of the screen. When the “SET” key is pressed, the screen goes back to item ① screen.

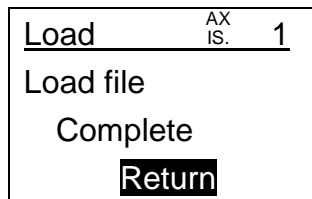

↓ Press the “SET” key.

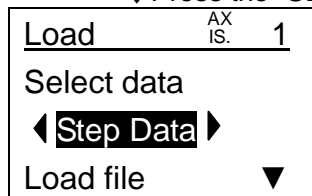

(8-3-2-2) “Load to Ctrl” items

The load to ctrl items are changed as follows.

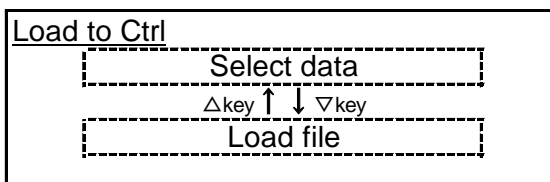

(8-3-3) "Delete"

- It is possible to delete the file data that is saved in the teaching box.

(8-3-3-1) "Delete" screen and the operating procedure

① Selection of file to be deleted.

Select the file to be deleted with the "◀ ▶" key and press the "SET" key.

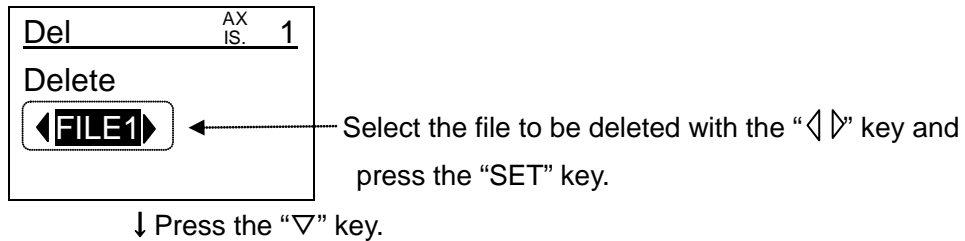

② Execution confirmation

Whether or not the file delete is executed is confirmed.

Display "Yes" in black highlight and press the "SET" key to delete the file.

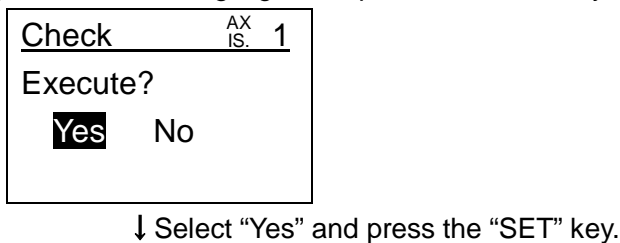

③ File delete is completed

The name of the deleted file becomes "FILE*(NODATA)" and the file data is deleted.

"*" shows numbers from 1 to 4.

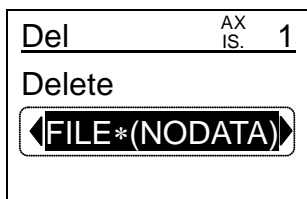

(8-3-4) "Protect" (This function is only for TB Ver2.**)

- TB Ver2.**, the file that are saved in the teaching box can be protected from overwriting, deletion and changing of the file name. (TB Ver1.**, the saved file cannot be protected.)

*Refer to "5.1(1)" to confirm TB Ver.

(8-3-4-1) "Protect" screen and the operating procedure

(a) Protect the file data.

① Select the file to be protected

Select the file to be protected with the "◀ ▶" key.

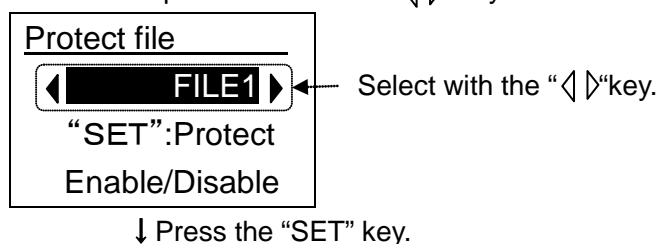

②Protect

When the "SET" key is pressed, the selected file is protected.

When the file is protected, "(filename)" and "Protected file" are alternately displayed in the file name.

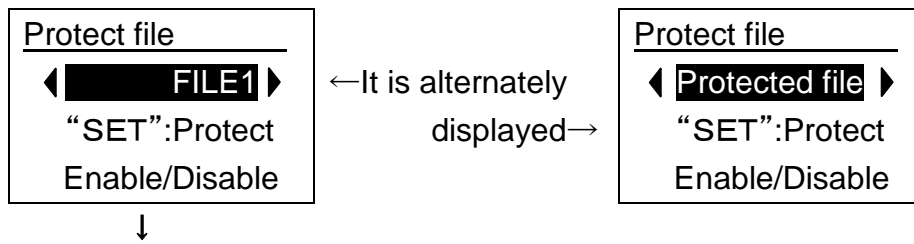

③The protection of the file is completed.

(b)Reset of the protection.

①Select the protected file to be reset.

Select the protected file to be reset with the "◀▶" key.

When the protected file is selected, "(filename)" and "Protected file" are alternately displayed in the file name.

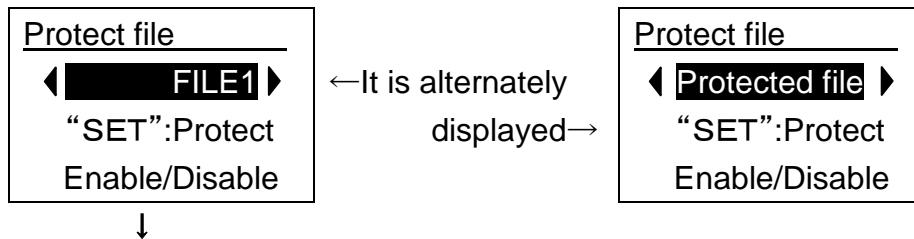

②Reset of the protection.

Press the "SET" key, and the protection of the file is reset.

After the protection of the file is reset, "(file name)" is only displayed.

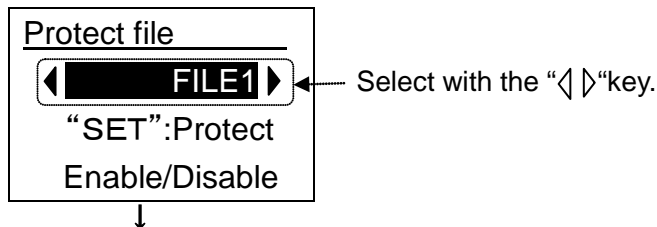

③Reset of the protection is completed.

(9) Normal mode “TB setting”

- It is possible to change the setting of the teaching box itself.

(9-1) TB setting screen and the setting procedure

- ① Select the item “TB setting” in the menu screen.

Select the item to be set with the “△▽” key.

When choices of the setting item are selected : The choice is displayed in black highlight.
 When numbers of the setting item are selected : A cursor is indicated under the numbers.

The item that is displayed in the second line of the screen is currently selected.

The setting content (number or choice) is displayed in the third line of the screen.

TB setting screen (When the setting content is choices.)

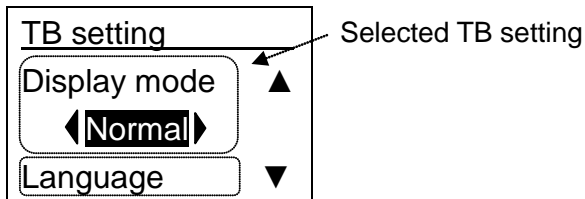

TB setting screen (When the setting content is numbers.)

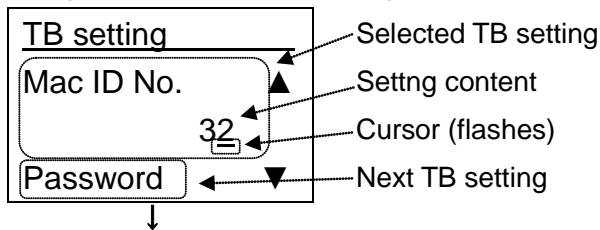

- ② Input and set of the numbers

In each setting, when the setting value is numbers, input values with number keys, and when the setting value is an choice, change the choice with the “◀▶” key and set it with the “SET” key.

* If the “△▽” key is pressed without pressing the “SET” key, input values and changed choices will be cancelled.

TB setting screen (When the setting value is an choice.)

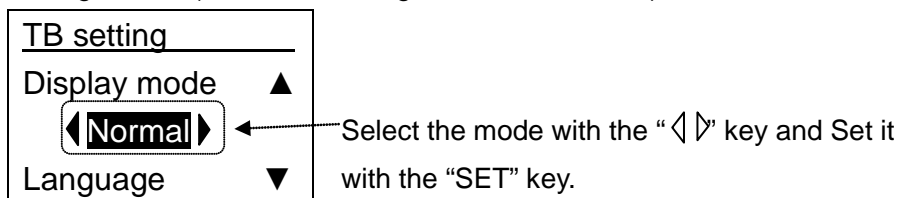

TB setting screen (When the setting content is numbers.)

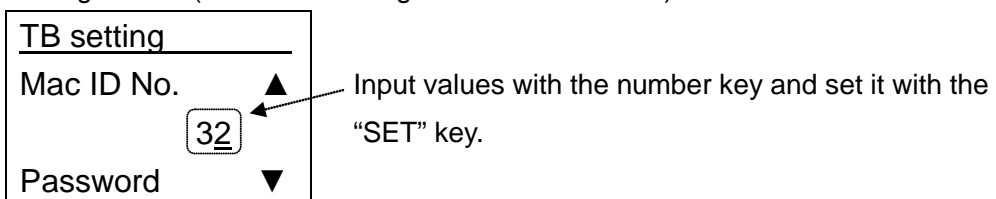

(9-2) TB setting item

The TB setting items are changed as follows.

* When the display mode (easy / normal) is changed, the screen will start from the initial screen.

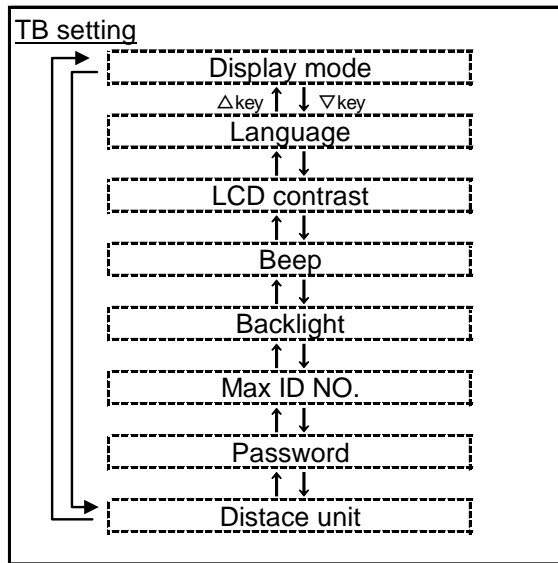

(9-3) TB setting item details

① "Display mode"

The display mode of the teaching box is set between easy mode and normal mode.

Easy : Easy mode. This display mode has minimum functions and allows users to select those functions by icons. It is easy to operate actuators with jog and test functions.

Normal: Normal mode. All functions can be used with this display mode. This mode is for system designers.

② "Language"

The display language of the teaching box is set.

English : The teaching box screen is displayed in English.

Japanese: The teaching box screen is displayed in Japanese.

③ "LCD contrast"

The contrast of the liquid crystal display is set between 1 and 5 (The higher the number becomes, the brighter the contrast will be.).

④ "Beep"

The buzzer volume is set between OFF and numbers (1 to 4 : The higher the number becomes, the louder the volume will be).

If "OFF" is selected, the volume is muted.

⑤“Back light”

The back light of the liquid crystal screen is set between OFF and numbers (1 to 5) (The higher the number becomes, the brighter the back light will be.).

If “OFF” is selected, the back light always goes out.

⑥“Max ID No.”

In this function, the maximum ID number of the controller to which the teaching box is connected is set within the range from 1 to 32. The teaching box checks the ID number of the controller which can communicate from 1 to “Max ID No.” in the initial screen.

When this number is small, the time to check the ID number of controller in the initial screen becomes shorter.

The maximum time to check the ID number is calculated from the following equation.

$$\text{“Max ID No.”} \times 2 \text{ [sec]}$$

Note that if the controller whose ID number is more than the “Max ID number”, the teaching box cannot recognize the controller.

e.g.) In the case when the teaching box whose set “Max ID No.” is “3” is connected to two controllers whose set ID numbers are “3” and “5” respectively.

In the initial screen, since the teaching box searches the controller whose set ID number is from 1 to 3, the controller that is set by “3” is recognized by the teaching box and therefore the communication between the teaching box and controller is possible. However, since the controller that is set by “5” is not recognized by the teaching box, the communication between them is not possible.

⑦“Password”

It is not possible to input password.

(10) Normal mode “Reconnect”

- It is possible to reconfirm the connected axis (controller).

* If there are several axes (controllers) that are recognized by the teaching box, the axis (controller) with which the teaching box is communicating can be changed. Refer to “6.4 (1) Axis change”.

(10-1) Reconnect screen and the operating procedure

① Reconnection of the connected controller

Select the item “Reconnect” in the menu screen.

Display “Yes” in black highlight by pressing the $\leftarrow \rightarrow$ key and press the “SET” key to reconfirm the connected controller.

* In this function, the axis number (controller ID) of the connected controller is confirmed and recognized.

* If several controllers are connected and the controller IDs are overlapped, that leads to the alarm of the teaching box and the communication is not possible.

* The controller ID can be set in the parameter of the controller “Controller ID (Basic parameter)”.

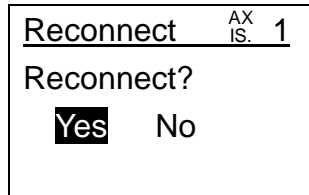

↓ Select “Yes” and press the “SET” key.

② Completed

The screen goes back to the menu and the setting is completed.

After reconnection, the communication with the axis number (controller ID) that is recognized by the teaching box at reconfirmation is possible.

6.4 Common function details between normal mode and easy mode

(1) Axis change

- When several axes (controllers) are connected, it is possible to communicate with each axis (controller) with one teaching box.
- On almost all screens, the axis can be changed.

* It is possible to communicate with any axis (controller) that is recognized by the teaching box when it is first connected to the axis (controller) or at reconfirmation of the connected axis.

* If only one axis (controller) is recognized, it cannot be changed.

(1-1) Axis change screen and the operating procedure

① Axis change selection

Press the “ESC” key on the screen where “AXIS” is displayed on the upper right of the screen, and display the axis number (controller ID) in black highlight.

Axis number: Controller ID. This number can be set in the basic parameter “Controller ID”.

e.g.) Menu

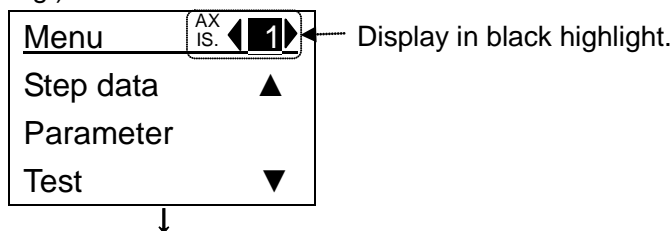

② Axis change

Any axis number (controller ID) that is recognized when the teaching box is first connected or at “Reconnect” in easy mode or normal mode can be selected with the “ ” key (number keys).

When the “SET” key is pressed after selecting the axis number (controller ID), the teaching box starts communicating with the controller whose controller ID is selected. After that, it is possible to execute the setting, test, monitor and file for the selected axis (controller).

* Among the axis (controllers) that are recognized by the teaching box when it is first connected or at reconfirmation of the reconnected axis, it is possible to change the axis that communicates with the teaching box.

* When only one axis controller is recognized, the axis cannot be changed.

* If an axis number (controller ID) that is not recognized by the teaching box is input with number keys and the “SET” key is pressed, the input is automatically cancelled and the teaching box communicates with the axis with which it was communicating immediately before the change.

e.g.) Menu

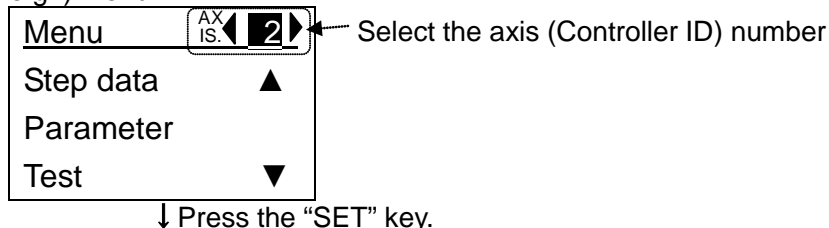

After that, it is possible to execute the setting, test, monitor and file for the selected axis (controller).

(2) Stop switch

- It is possible to stop by the stop switch of the teaching box.

(2-1) Stop screen and the operating procedure

① Screen of when the stop switch is being activated.

When the stop switch is pushed and locked, the screen that displays the "Stop-SW activated" appears. While this screen is displaying, the keys of the teaching box don't work at all.

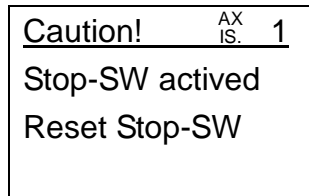

② How to use the stop switch

Once the stop switch is reset, normal operation of the communicating axis (controller) is available.

When the stop switch is pushed (activated), the communicating axis (controller) is stopped.

In the instance where the stop switch is activated, resetting of this switch is performed by rotating the reset button lightly clockwise.

The detailed operation is described as follows.

* When the stop switch is pushed (activated) :

The actuator that is connected to the controller with the teaching box is stopped.

After the actuator stops, the motor power of the actuator may be turned off (servo OFF).

Even though the motor power is ON (servo ON) when the actuator is in the process of stopping, if the stop switch is pushed (activated, the motor power of the actuator may be turned off (servo OFF).

In addition, while the stop switch is pushed (activated), the controller that is connected to the teaching box cannot receive any operation commands from any external device such as the PLC.

* When the stop switch is reset :

When the stop switch is reset, The teaching box reverts to the menu screen.

In the case that the motor power of the actuator is OFF (servo OFF), even When the stop switch is reset, the motor power remains turned off (servo OFF).

If operation command from an external device such as PLC is required, it is necessary to turn on (servo ON) the motor.

*Even if the stop switch of the teaching box is reset, when "EMG" input of the controller is OFF (Negative-true logic), the stop screen appears. Only if "EMG" input of the controller is ON and the stop switch of the teaching box is reset, teaching box can be operated.

(3) Enable switch

- The teaching box can operate controller (actuator) only when the enable switch is turned ON.
- * The enable switch is the switch that allows the actuator to move only when Test drive or JOG/MOVE function is executed by teaching box.

(3-1) Enable switch OFF screen and the operating procedure

*Refer to "5.1(1)" to confirm TB Ver.

When a teaching box with an enable switch (LEC-T1-***S) is purchased, it is necessary to activate the enable switch with the parameter of the controller.

In the parameter of the controller, the initial value of the enable switch is disabled.

Please set the parameter of the controller as follows.

Parameter group	Parameter name	Setting	(Initial setting)
Basic parameter	Enable switch	TB Ver1.**: "Enable" TB Ver2.**: "2"	TB Ver1.**: "Disable" TB Ver2.**: "1"

If the controller setting and the specifications of the teaching box do not match, the following problems will occur.

* If the enable switch setting of the controller is "Disabled" and a teaching box with an enable switch (LEC-T1-***S) is connecting to the controller :

Regardless of whether or not the enable switch is turned on or off on the teaching box, the actuator is always allowed to be operated from the teaching box.

* If the enable switch setting of the controller is "Enabled" and a teaching box without enable switch (LEC-T1-***S) is connecting to the controller :

The command from the teaching box is not allowed at all.

① Enable switch OFF screen

When the enable switch is switched OFF from ON status, the enable switch OFF screen appears.

While this screen is displaying, the keys of the teaching box do not work at all.

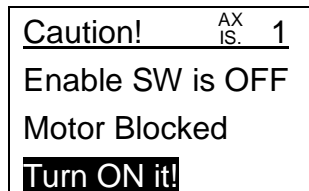

②How to use the enable switch

For the teaching box with an enable switch, the enable switch is a three position switch. The ON/OFF status is changed by pressing the enable switch as follows.

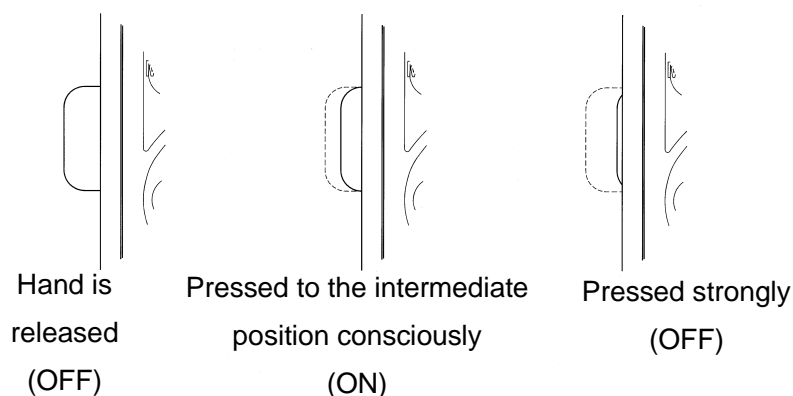

During the manual operation, if an unexpected actuator motion occurs, releasing or strongly pressing enable switch on the teaching box stops the actuator motion and the motor power turns off (servo OFF)

The detailed operating procedure is stated below.

* When the enable switch is turned ON:

It is possible to direct the commands to the actuator from the teaching box that is connected to the controller.

* When the enable switch is turned OFF:

In the instance when an actuator that is controlled by the teaching box is in motion, the actuator will stop and motor power turned off (servo OFF).

While the enable switch is OFF, the controller cannot receive any further operation commands from the teaching box.

7. Wiring of cables/Common precautions

Warning

1. **Adjusting, mounting or wiring change should never be done before shutting off the power supply to the product.**
Electrical shock, malfunction and damaged can result.
2. **Never disassemble the cable. Use only specified cables.**
3. **Never connect or disconnect the cable or connector with power on.**

Caution

1. **Wire the connector securely. Do not apply any voltage to the terminals other than those specified in the product manual.**
2. **Wire the connector securely.**
Check for correct connector wiring and polarity.
3. **Take appropriate measures against noise.**
Noise in a signal line may cause malfunction. As a countermeasure, separate high voltage and low voltage cables, and shorten wiring lengths, etc.
4. **Do not route wires and cables together with power or high voltage cables.**
The product can malfunction due to interference of noise and surge voltage from power and high voltage cables to the signal line. Route the wires of the product separately from power or high voltage cables.
5. **Take care that actuator movement does not catch cables.**
6. **Operate with cables secured. Avoid bending cables at sharp angles where they enter the product.**
7. **Avoid twisting, folding, rotating or applying an external force to the cable.**
Risk of electric shock, wire break, contact failure and lost of control for the product can happen.

8. **Fix the cable protruding from the product in place before using.**

The motor and lock cables are not robotic type cables and can be damaged when moved. Therefore fix the cables and the connectors (part "A" in figure below) when setting up.

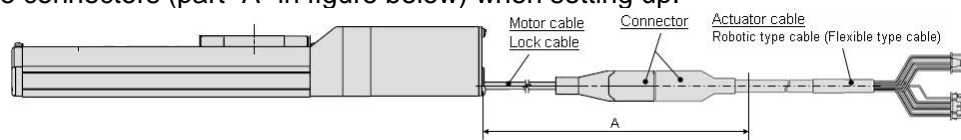

9. **Select "Robotic type cables" in case of bending the actuator-cable repeatedly and do not put cables into a flexible moving tube with a radius smaller than the specified value. (Min. 50mm).**

Risk of electric shock, wire break, contact failure and loss of control for the product can happen if "Standard cables" are used in case of inflecting the cables repeatedly.

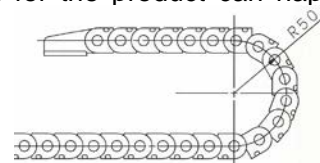

10. **Confirm proper wiring of the product.**

Poor insulation (interference with other circuits, poor insulation between terminals and etc.) can apply excessive voltage or current to the product causing damage.

11. **The Speed / pushing force may vary, depending on the cable length, load and mounting conditions etc..**

If the cable length exceeds 5m, the speed / pushing force will be reduced 10% per 5m as the maximum.
(If cable length is 15m: 20% reduction as the maximum.)

[Transportation]

Caution

1. **Do not carry or swing the product by the motor or the cable.**

8. Electric actuators/Common precautions

8.1 Design and selection

Warning

- 1. Be sure to read the Operation Manual (this manual and the one for the controller: LEC series).**

Handling or usage/operation other than that specified in the Operation Manual may lead to breakage and operation failure of the product.

Any damage attributed to the use beyond the specifications is not guaranteed.
- 2. There is a possibility of dangerous sudden action by the product if sliding parts of machinery are twisted due to external forces, etc.**

In such cases, human injury may occur, such as by catching hands or feet in the machinery, or damage to the machinery itself may occur. Design the machinery should be designed to avoid such dangers.
- 3. A protective cover is recommended to minimize the risk of personal injury.**

If a driven object and moving parts of the product are in close proximity, personal injury may occur. Design the system to avoid contact with the human body.
- 4. Securely tighten all stationary parts and connected parts so that they will not become loose.**

When the product operates with high frequency or is installed where there is a lot of vibration, ensure that all parts remain secure.
- 5. Consider a possible loss of power source.**

Take measures to prevent injury and equipment damage even in the case of a power source failure.
- 6. Consider behavior of emergency stop of whole system.**

Design the system so that human injury and/or damage to machinery and equipment will not be caused, when it is stopped by a safety device for abnormal conditions such as a power outage or a manual emergency stop of whole system.
- 7. Consider the action when operation is restarted after an emergency stop or abnormal stop of whole system.**

Design the system so that human injury or equipment damage will not occur upon restart of operation of whole system.
- 8. Disassembly and modification prohibited**

Do not modify or reconstruct (including additional machining) the product. An injury or failure can result.
- 9. Do not use stop signal, "EMG" of the controller and stop switch on the teaching box as the emergency stop of system.**

The stop signal, "EMG" of controller and the stop switch on the teaching box are for decelerating and stopping the actuator. Design the system with an emergency stop circuit which is applied relevant safety standard separately.
- 10. When using it for vertical application, it is necessary to build in a safety device.**

The table may fall due to the weight of work. The safety device should not interfere with normal operation of the machine.

Caution

- 1. Operate within the limits of the maximum usable stroke.**

The product will be damaged if it is used with the stroke which is over the maximum stroke. Refer to the specifications of the product.
- 2. When the product repeatedly cycles with partial strokes, operate it at a full stroke at least once a day or every 1000 strokes.**

Otherwise, lubrication can run out.

3. **Do not use the product in applications where excessive external force or impact force is applied to it.**

The product can be damaged. Each component that includes motor is made with accurate tolerance. So even slightly deformed or miss-alignment of component may lead operation failure of the product.

4. **Rerutting to origin cannot be done during the operation.**

It cannot be done during positioning operation, pushing operation and pushing.

5. **Refer to a common auto switch /matter (Best Pneumatics No 2) when an auto switch is built in and used.**
6. **When conformity to UL is required, the electric actuator and controller should be used with a UL1310 Class 2 power supply.**

8.2 Mounting

Warning

1. **Install and operate the product only after reading the Operation Manual carefully and understanding its contents. Keep the manual in a safe place future reference.**

2. **Observe the tightening torque for screws.**

Tighten the screws to the recommended torque for mounting the product.

3. **Do not make any alterations to this product.**

Alterations made to this product may lead to a loss of durability and damage to the product, which can lead to human injury and damage to other equipment and machinery.

4. **When using external guide, the guide axis should be parallel to the actuator axis.**

There will be damage/excessive wear on the lead screw if the external guide is not parallel.

5. **When an external guide is used, connect the moving parts of the product and the load in such a way that there is no interference at any point within the stroke.**

Do not scratch or dent the sliding parts of the slideways or finger assemblies etc., by striking or grasping them with other objects. Components are manufactured to precise tolerances, so that even a slight deformation may cause faulty operation.

6. **Prevent the seizure of rotating parts.**

Prevent the seizure of rotating parts (pins, etc.) by applying grease.

7. **Do not use the product until you verify that the equipment can operate properly.**

After mounting or repair, connect the power supply to the product and perform appropriate functional inspections to check it is mounted properly.

8. **Cantilever**

When the actuator is operated at high speed while it is fixed at one end and free at the other end (flange type, foot type, double clevis type, direct mount type), a bending moment may act on the actuator due to vibration generated at the stroke end, which can damage the actuator. In such a case, install a support bracket to suppress the vibration of the actuator body or reduce the speed so that the actuator does not vibrate. Use a support bracket also when moving the actuator body or when a long stroke actuator is mounted horizontally and fixed at one end.

9. **When mounting the actuator or attaching to the work piece, do not apply strong impact or large moment.**

If an external force over the allowable moment is applied, it may cause looseness in the guide unit, an increase in sliding resistance or other problems.

10. **Maintenance space**

Allow sufficient space for maintenance and inspection.

8.3 Handling

Warning

- 1. Do not touch the motor while in operation.**

The surface temperature of the motor can increase to approx. 90oC to 100oC due to operating conditions. This temperature increase may also be caused by energizing alone. As it may cause burns, do not touch the motor when in operation.
- 2. If abnormal heating, smoking or fire, etc., occurs in the product, immediately shut off the power supply.**
- 3. Immediately stop operation if abnormal operation noise or vibration occurs.**

In case abnormal operation noise or vibration occurs, the product may have been improperly mounted. Unless operation is stopped for inspection, machinery can be seriously damaged.
- 4. Never touch the rotating part of the motor while in operation.**
- 5. When installing, adjusting, inspecting or performing maintenance on the product, controller and related equipment, be sure to shut off the power supply to each of them. Then, lock it so that no one other than the person working can turn the power on, or implement measures such as a safety plug.**
- 6. In the case of the actuator that has a servo motor (24VDC), the “motor phase detection step” is done by inputting the servo on signal just after the controller power is turned on. The “motor phase detection step” moves the table/rod for the distance of the one screw-lead as the maximum. (The motor rotates in the reverse direction if the table hits an obstacle such as the end stop damper.) Take the “motor phase detection step” into consideration for the installation and operation of this actuator.**

Caution

- 1. Keep the controller and product combined as delivered for use.**

The product is set in parameters for shipment. If it is combined with a different parameter, failure can result.
- 2. Check the product for the following points before operation.**
 - a) Damage to electric driving line and signal lines
 - b) Looseness of the connector to each power line and signal line
 - c) Looseness of the actuator/cylinder and controller/driver mounting
 - d) Abnormal operation
 - e) Emergency stop of the total system
- 3. When more than one person is performing work, decide on the procedures, signals, measures and resolution for abnormal conditions before beginning the work. Also, designate a person to supervise work other than those performing work.**
- 4. The product can operate at a different speed from the set speed depending on load and resistance.**

When selecting a product, check the catalog for the instructions regarding selection and specifications.
- 5. Do not apply a load, impact or resistance in addition to a transferred load during return to origin.**

The product is made return to origin by pushing force, which causes the displacement of origin.
- 6. Do not remove the name plate.**
- 7. Operation test should be done by low speed. Start operation by predefined speed after confirming there is no trouble.**

[Earth]

Warning

- 1. Please give the earth to the actuator.**
- 2. The earth should be exclusive use. (Less than 100Ω)**
- 3. The earth cable length should be as short as possible.**

[Unpackaging]

Caution

1. Check the received product is as ordered.

If a different product is installed from the one ordered, injury or damage can result.

8.4 Operating environment

Warning

1. Avoid use in the following environments.

- a. Locations where a large amount of dusts and cutting chips are airborne.
- b. Locations where the ambient temperature is outside the range of the temperature specification (refer to specifications).
- c. Locations where the ambient humidity is outside the range of the humidity specification (refer to specifications).
- d. Locations where corrosive gas, flammable gas, sea water, water and steam are present.
- e. Locations where strong magnetic or electric fields are generated.
- f. Locations where direct vibration or impact is applied to the product.
- g. Areas that are dusty, or are exposed to splashes of water and oil drops.
- h. Areas exposed to direct sunlight (ultraviolet ray).

2. Do not use in an environment where the product is directly exposed to liquid, such as cutting oils.

If cutting oils, coolant or oil mist contaminates the product, failure or increased sliding resistance can result.

3. Install a protective cover when the product is used in an environment directly exposed to foreign matters such as dust, cutting chips and spatter.

Play or increased sliding resistance can result.

4. Shade the sunlight in the place where the product is applied with direct sunshine.

5. Shield the valve from radiated heat generated by nearby heat sources.

When there is a heat source surrounding the product, the radiated heat from the heat source can increase the temperature of the product beyond the operating temperature range. Protect it with a cover, etc.

6. Grease oil can be decreased due to external environment and operating conditions, and it deteriorates lubrication performance to shorten the life of the product.

[Storage]

Warning

1. Do not store the product in a place in direct contact with rain or water drops or is exposed to harmful gas or liquid.

2. Store in an area that is shaded from direct sunlight and has a temperature and humidity within the specified range (-10oC to 60oC and 35 to 90% no freezing or icing).

3. Do not apply vibration and impact to the product during storage.

8.5 Maintenance

Warning

- 1. Do not disassemble or repair the product.**
Fire or electric shock can result.
- 2. Before modifying or checking the wiring, the voltage should be checked with a tester 5 minutes after the power supply is turned off.**
Electrical shock can result.

Caution

- 1. Maintenance should be performed according to the procedure indicated in the Operating Manual.**
Improper handling can cause injury, damage or malfunction of equipment and machinery.
- 2. Removal of product.**
When equipment is serviced, first confirm that measures are in place to prevent dropping of work pieces and run-away of equipment, etc, and then cut the power supply to the system. When machinery is restarted, check that operation is normal with actuators in the proper positions.

[Lubrication]

Caution

- 1. The product has been lubricated for life at manufacturer, and does not require lubrication in service.**
When lubrication is applied, a special grease must be used.
Please read the maintenance manual of each actuator.

8.6 Precautions for actuator with lock

Warning

- 1. Do not use the lock as a safety lock or a control that requires a locking force.**
The lock used for the product with a lock is designed to prevent dropping of work piece.
- 2. For vertical mounting, use the product with a lock.**
If the product is not equipped with a lock, the product will move and drop the work piece when the power is removed.
- 3. "Measures against drops" means preventing a work piece from dropping due to its weight when the product operation is stopped and the power supply is turned off.**
- 4. Do not apply an impact load or strong vibration while the lock is activated.**
If an external impact load or strong vibration is applied to the product, the lock will lose its pushing force and damage to the sliding part of the lock or shortening of lifespan can result. The same situations will happen when the lock slips due to a force over the thrust of the product, as this accelerates the wear to the lock.
- 5. Do not apply liquid or oil and grease to the lock or its surrounding.**
When liquid or oil and grease is applied to the sliding part of the lock, its pushing force will reduce significantly.
- 6. Take measures against drops and check that safety is assured before mounting, adjustment and inspection of the product.**
If the lock is released with the product mounted vertically, a work piece can drop due to its weight.
- 7. When the actuator is operated manually (when SVRE output signal is off), supply 24DCV to the [BK RLS] terminal of the power supply connector.**
If the product is operated without releasing the lock, wearing of the lock sliding surface will be accelerated, causing reduction in the holding force and the life of the locking mechanism.
- 8. Do not supply 24VDC power supply constantly to the [BK RLS(Lock release)] terminal.**
Stop supplying 24VDC power supply to the [BK RLS(Lock release) terminal during normal operation. If power is supplied to the [BK RLS] terminal continuously, the lock will be released, and workpieces may be dropped at stop (EMG).

/Refer to the operation manual of LEC (controller) for details of wiring.

9. Precautions: Controller and its peripheral devices Electric actuators/Common precautions

9.1 Design and selection

Warning

1. Be sure to apply the specified voltage.

Otherwise, a malfunction and breakage of the controller may be caused.

If the applied voltage is lower than the specified, it is possible that the load cannot be moved due to an internal voltage drop. Please check the operating voltage before use.

2. Do not operate beyond the specifications.

It may cause a fire, malfunction or actuator damage can result. Please check the specifications before use.

3. Install an emergency stop circuit.

Please install an emergency stop outside of the enclosure so that it can stop the system operation immediately and intercept the power supply.

4. In order to prevent danger and damage due to the breakdown and the malfunction of this product, which may occur at a certain probability, a backup system should be established previously by giving a multiple-layered structure or a fail-safe design to the equipment, etc.

5. If a fire or danger against the personnel is expected due to an abnormal heat generation, ignition, smoking of the product, etc., cut off the power supply for this product and the system immediately.

9.2 Handling

Warning

1. The inside of the controller and its connector should not be touched.

It may cause an electric shock or damage to the controller.

2. Do not perform the operation or setting of this equipment with wet hands.

It may cause an electric shock.

3. Product with damage or the one lacking of any components should not be used.

It may cause an electric shock, fire, or injury.

4. Use only the specified combination between the controller and electric actuator.

It may cause damage to the controller or the actuator.

5. Be careful not to be caught or hit by the workpiece while the actuator is moving.

It may cause an injury.

6. Do not connect the power supply or power on the product before confirming the area where the work moves is safe.

The movement of the work may cause accident.

7. Do not touch the product when it is energized and for some time after power has been disconnected, as it is very hot.

It may lead to a burn due to the high temperature.

8. Check the voltage using a tester for more than 5 minute after power-off in case of installation, wiring and maintenance.

There is a possibility of getting electric shock, fire and injury.

9. **Do not use in an area where dust, powder dust, water or oil is in the air.**
It will cause failure or malfunction.
10. **Do not use in an area where a magnetic field is generated.**
It will cause failure or malfunction.
11. **Do not install in the environment of flammable gas, corrosive gas and explosive gas.**
It could lead to fire, explosion and corrosion.
12. **Radiant heat from strong heat sources such as a furnace, direct sunlight, etc. should not be applied to the product.**
It will cause failure of the controller or its peripheral devices.
13. **Do not use the product in an environment subject to a temperature cycle.**
It will cause failure of the controller or its peripheral devices.
14. **Do not use in a place where surges are generated.**
When there are units that generate a large amount of surge around the product (e.g., solenoid type lifters, high frequency induction furnaces, motors, etc.), this may cause deterioration or damage to the product's internal circuit. Avoid sources of surge generation and crossed lines.
15. **Do not install this product in an environment under the effect of vibrations and impacts.**
It will cause failure or malfunction.
16. **If this product is used with a relay or solenoid valve, they should be the surge absorbing element built-in type.**
17. **After the screen has switched completely, operate the teaching-box according to the instruction on the screen.**
It will cause malfunction or accident.

9.3 Installation

Warning

1. **The controller and its peripheral devices should be installed on a fire-proof material.**
A direct installation on or near a flammable material may cause fire.
2. **Do not install this product in a place subject to vibrations and impacts.**
It may cause an electric shock, fire, or injury.
3. **Take measure so that the operating temperature of this controller and its peripheral devices are within the range of the specifications. Also, this controller should be installed with 50mm or larger spaces between each side of it and the other structures or components.**
It may cause a malfunction of the controller and its peripheral devices and a fire.
4. **Do not mount this controller and its peripheral devices together with a large-sized electromagnetic contactor or no-fuse breaker, which generates vibration, on the same panel. Mount them on different panels, or keep the controller and its peripheral devices away from such a vibration source.**
5. **This controller and its peripheral devices should be installed on a flat surface.**
If the mounting surface is distorted or not flat, an unacceptable force may be added to the housing, etc. to cause troubles.

9.4 Wiring of cables/Common precautions

Warning

- 1. Do not apply any excessive force to cables by repeated bending, tensioning or placing a heavy object on the cables.**

It may cause an electric shock, fire, or breaking of wire.
- 2. Connect wires and cables correctly.**

Incorrect wiring could break the controller or its peripheral devices depending on the seriousness.
- 3. Do not connect wires while the power is supplied.**

It can break the controller or its peripheral devices could be damaged to cause a malfunction.
- 4. Do not carry this product by holding its cables.**

It may cause an injury or damage to the product.
- 5. Do not connect power cable or high-voltage cable in the same wiring route as the unit.**

The wires to the controller or its peripheral devices can be interrupted with noise or induced surge voltage from power lines or high-voltage lines and malfunction could be caused.
Separate the wiring of the controller and its peripheral device from that of power line and high voltage line.
- 6. Verify the insulation of wiring.**

Insulation failure (interference with other circuit, poor insulation between terminals and etc.) could introduce excessive voltage or current to the controller or its peripheral devices and damage them.

9.5 Power supply

Caution

- 1. Use a power supply that has low noise between lines and between power and ground.**

In cases where noise is high, an isolation transformer should be used.
- 2. The power supplies should be separated between the controller power and the I/O signal power and both of them should be the instantaneous output type.**

If the power supplies are not the instantaneous output type, a voltage drop may be caused during the acceleration of the actuator.
- 3. To prevent surges from lightning, an appropriate measure should be taken. Ground the surge absorber for lightning separately from the grounding of the controller and its peripheral devices.**

9.6 Grounding

Warning

- 1. Be sure to carry out grounding in order to ensure the noise tolerance of the controller.**

It may cause an electric shock or fire.
- 2. Dedicated grounding should be used.**

Grounding should be to a D-class ground (Ground resistance of 100Ω or less.)

3. **Grounding should be performed near the unit as much as possible to shorten the grounding distance.**
4. **In the unlikely event that malfunction is caused by the ground, it may be disconnected.**

9.7 Maintenance

Warning

1. **Perform a maintenance check periodically**

Confirm wiring and screws are not loose.

Loose screws or wires may cause unintentional malfunction.

2. **Conduct an appropriate functional inspection after completing the maintenance.**

In case of any abnormalities (in the case that the actuator does not move, etc.), stop the operation of the system. Otherwise, an unexpected malfunction may occur and it will become impossible to secure the safety.

3. **Do not disassemble, modify or repair this controller and the peripheral equipment.**

4. **Do not put anything conductive or flammable inside of this controller.**

It may cause a fire and explosion.

5. **Do not conduct an insulation resistance test and withstand voltage test on this product.**

6. **Ensure sufficient space for maintenance activities. Provide space required for maintenance.**

Design the system that allows required space for maintenance.

10. Troubleshooting

For alarms, descriptions and countermeasures refer to the troubleshooting of the “Controller operation manual” for the connected controller.

The alarms, descriptions and countermeasures that are specific to the teaching box are stated below.

No.	TB alarm	Descriptions	Countermeasures
1	Connect error	Communication error when the connected axis is reconfirmed.	<p>The cause is assumed to be one of the following. Solve the problems and connect the teaching box again. If the teaching box doesn't return to normal operation, please contact the SMC sales representatives.</p> <ol style="list-style-type: none"> 1. The value set in the “TB setting” and “MAX ID No.” of the teaching box normal mode is less than the ID number of the controller. 2. The silent interval set value of the connected controller is other than “1”. 3. The connector is not properly inserted into the teaching box. 4. The cable of the teaching box is broken. 5. CN4 connector of the controller has a problem. 6. Noise
2	CRC error	Communication error	<p>The cause is assumed to be one of the following. Solve the problems and connect the teaching box again.</p> <p>If the teaching box doesn't return to normal operation, please contact the SMC sales representatives.</p> <ol style="list-style-type: none"> 1. The connector is not properly inserted into the teaching box 2. The cable of the teaching box is broken. 3. Noise 4. Power supply voltage error
3	Missing func		
4	ID not found		
5	Number over		
6	Point over		
7	Short data		
8	Echo error	Communication error when the connected axis is reconfirmed.	<p>The cause is assumed to be one of the following. Solve the problems and connect the teaching box again. If the teaching box doesn't return to normal operation, please contact the SMC sales representatives.</p> <ol style="list-style-type: none"> 1. IDs of the connected controllers are overlapping. 2. The connector is not properly inserted into the teaching box 3. The cable of the teaching box is broken 4. Noise 5. Power supply voltage error

9	ExFlash error	There are some problems in the teaching box.	The cause is assumed to be one of the following. Reset the alarm, and If the teaching box doesn't return to normal operation, please contact the SMC sales representatives. 1. Noise 2. Failure of the internal parts of the teaching box.
10	DFlash error		
11	Resp timeout	Communication is not available.	The cause is assumed to be one of the following. Solve the problems and connect the teaching box again. If the teaching box doesn't return to normal operation, please contact the SMC sales representatives. 1. When the teaching box is connected to several controllers, the controller to which the teaching box is intended to communicate with is disconnected. 2. The silent interval set value of the connected controller is other than "1". 3. The connector is not properly inserted into the teaching box 4. The cable of the teaching box is broken 5. CN4 connector of the controller has a problem. 6. Noise

Directions of the teaching box

- (1) life-cycle of back light of the liquid crystal display (LCD) is about 10,000 hours in under normal conditions.
- (2) Avoid using or exposing the teaching box for a long periods of time under direct sunshine or the ultraviolet rays. The life-cycle of the liquid crystal display (LCD) is shortened remarkably by ultraviolet rays.
- (3) Avoid using organic solvent when cleaning the teaching box. The resin of the teaching box can react with organic solvent.
- (4) After the screen has switched completely, operate the teaching-box according to the instruction on the screen. It will cause malfunction or accident.

Appendix

How to change the language from Japanese to English

- * TB Ver1.**: The language can change only in normal mode.
- * TB Ver2.**: The language can change in normal mode and easy mode
- * Refer to "5.1(1)" to confirm TB Ver.

(1) TB Ver1.**

*Refer to "5.1(1)" to confirm TB Ver.

In easy mode: After the mode is changed from easy mode to normal mode, the language is changed from Japanese to English in the "TBsetting" of normal mode. (Refer to "Appendix(2-1)")

In normal mode: The language is changed from Japanese to English in the "TBsetting" of normal mode. (Refer to "Appendix(1-2)")

(1-1) Change from easy mode to normal mode

① Select the "SETTING".

Press the "MENU" key to shift it to the menu screen.

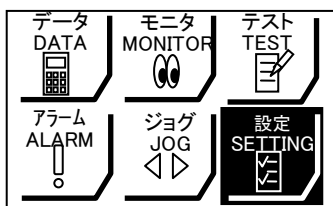

↓ Press the "SET" key.

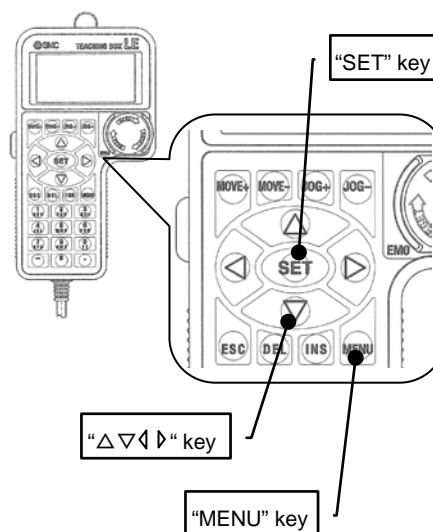

② Change to easy mode.

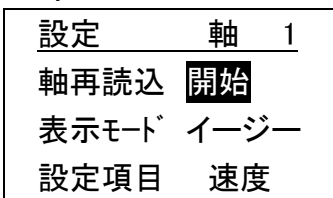

↓ Press the "▽" key once to select the choice of the item "表示モード".

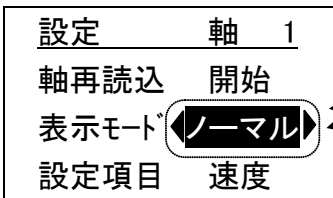

Select "ノーマル" by pressing the "◀▶" key, and press "SET" key to determine.

↓ Press the "SET" key.

③ Mode change completed.

The screen is changed to the initial screen, and then displays the menu in normal mode in Japanese.



(1-2) Change the language from Japanese to English in normal mode.

① Select the item “TB 設定”.

Press the “MENU” key to shift it to the menu screen.

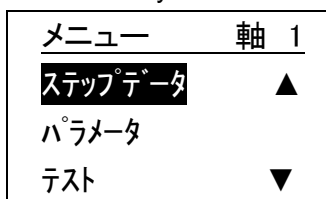

↓ Press the “△” key twice or “▽” key 6 times to select the item “TB 設定”.

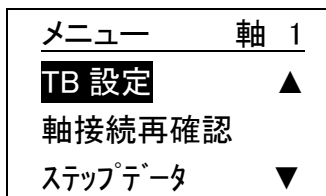

↓ Press the “SET” key.

② Change the language.

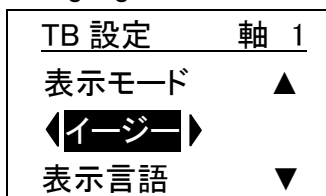

↓ Press the “▽” key once to select the choice of the item “表示言語”.

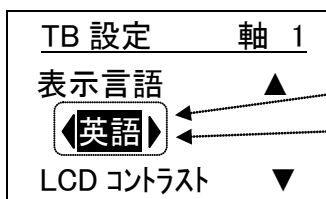

Select “英語” by pressing the “◀▶” key, and press “SET” key to determine.

↓ Press the “SET” key.

③ The language change completed.

The language is displayed in English.

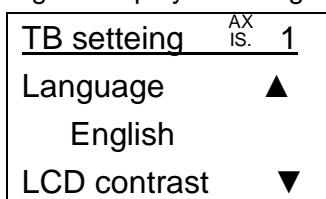

↓ Press the “SET” key.

When the operation of the teaching box is continued in normal mode :

Press the “MENU” key to go back to the menu screen, and then, operate other function.

When the operation of the teaching box is changed to easy mode :

Change to easy mode referring to ”5.3 (2) How to change from normal mode to easy mode”, and then, operate other function.

(2) TB Ver2.**

*Refer to "5.1(1)" to confirm TB Ver.

In easy mode: The language is changed from Japanese to English in the "SETTING" of easy mode. (Refer to "Appendix(2-1)")

In normal mode: The language is changed from Japanese to English in the "TBsetting" of normal mode. (Refer to "Appendix(1-2)").

(2-1) Change the language from Japanese to English in easy mode

① Select the "SETTING".

Press the "MENU" key to shift it to the menu screen.

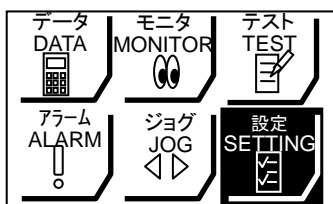

↓ Select "SETTING",
and press the "SET" key.

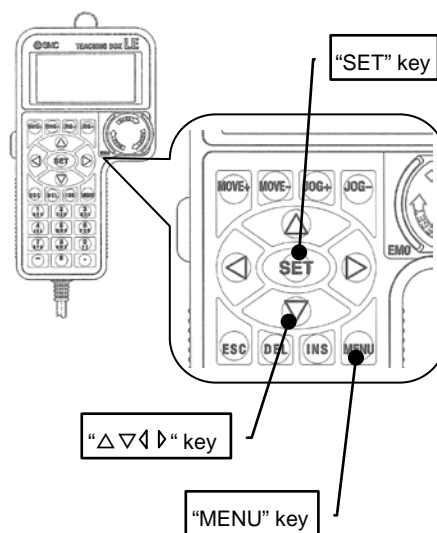

② Change the language

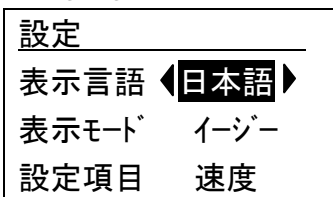

↓ Press the "▶" key once to select the choice "Eng"



↓ Press the "SET" key.

③ The language change completed.

The language is displayed in English.

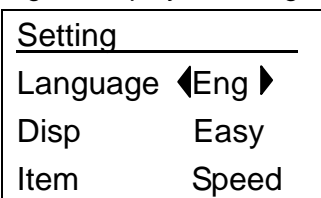

Press the "MENU" key to go back to the menu screen, and then, operate other function.

Revision history

No.LEC-OM00501

Sep/2008 1st printing

TB Ver. : 1.**

No.LEC-OM00503

Jun/2011 Revision

TB Ver. : 1.**, 2.**

- Addition / Operation for TB ver. 2.**

No.LEC-OM00504

Apr/2012 Revision

- Addition / Notes about UL recognition.

No.LEC-OM00505

Dec/2012 Revision

- Addition / Operation for TB ver. 2.1* or more
(Corresponds of connecting to LECPA.)

No.LEC-OM00506

Apr/2015 Revision

- Addition / Communication settings
- Addition / LECPMJ

SMC Corporation

4-14-1, Sotokanda, Chiyoda-ku, Tokyo 101-0021 JAPAN

Tel: + 81 3 5207 8249 Fax: +81 3 5298 5362

URL <http://www.smcworld.com>

Note: Specifications are subject to change without prior notice and any obligation on the part of the manufacturer.

© 2012 SMC Corporation All Rights Reserved.