



Operation Manual

PRODUCT NAME

Sensor Monitor

MODEL / Series / Product Number

PSE3##A

SMC Corporation

Table of Contents

Safety Instructions	2
Model Indication and How to Order	8
Summary of Product parts	9
Definition and terminology	10
Mounting and Installation	13
Installation	13
Wiring	15
Pressure Setting	19
Outline of Settings	20
Initial Setting	21
3 Step Setting Mode	24
Simple Setting Mode	26
Function Selection Mode	28
Function selection mode	28
Default setting	28
F 0 Units selection function	30
F 1 Setting of OUT1	34
F 2 Setting of OUT2	37
F 3 Digital filter setting	39
F 4 Auto-preset function	40
F 5 FUNC terminal setting	42
F 6 Fine adjustment of display value	46
F10 Sub display setting	47
F11 Display resolution setting	53
F80 Power saving mode	54
F81 Security code	55
F82 Input of line name	57
F90 Setting of all functions	58
F96 Input signal check	60
F97 Selection of copy check	61
F98 Output check	63
F99 Reset to default settings	65
Other Settings	66
Maintenance	70
Forgotten the security code	70
Troubleshooting	71
Specifications	78
Dimensions	80



Safety Instructions

These safety instructions are intended to prevent hazardous situations and/or equipment damage. These instructions indicate the level of potential hazard with the labels of "Caution", "Warning" or "Danger". They are all important notes for safety and must be followed in addition to International Standards (ISO/IEC)*1), and other safety regulations.

*1) ISO 4414: Pneumatic fluid power -- General rules relating to systems.

ISO 4413: Hydraulic fluid power -- General rules relating to systems.

IEC 60204-1: Safety of machinery -- Electrical equipment of machines .(Part 1: General requirements)

ISO 10218: Manipulating industrial robots -Safety.

etc.



Caution

Caution indicates a hazard with a low level of risk which, if not avoided, could result in minor or moderate injury.



Warning

Warning indicates a hazard with a medium level of risk which, if not avoided, could result in death or serious injury.



Danger

Danger indicates a hazard with a high level of risk which, if not avoided, will result in death or serious injury.

Warning

1. The compatibility of the product is the responsibility of the person who designs the equipment or decides its specifications.

Since the product specified here is used under various operating conditions, its compatibility with specific equipment must be decided by the person who designs the equipment or decides its specifications based on necessary analysis and test results.

The expected performance and safety assurance of the equipment will be the responsibility of the person who has determined its compatibility with the product.

This person should also continuously review all specifications of the product referring to its latest catalog information, with a view to giving due consideration to any possibility of equipment failure when configuring the equipment.

2. Only personnel with appropriate training should operate machinery and equipment.

The product specified here may become unsafe if handled incorrectly.

The assembly, operation and maintenance of machines or equipment including our products must be performed by an operator who is appropriately trained and experienced.

3. Do not service or attempt to remove product and machinery/equipment until safety is confirmed.

1. The inspection and maintenance of machinery/equipment should only be performed after measures to prevent falling or runaway of the driven objects have been confirmed.

2. When the product is to be removed, confirm that the safety measures as mentioned above are implemented and the power from any appropriate source is cut, and read and understand the specific product precautions of all relevant products carefully.

3. Before machinery/equipment is restarted, take measures to prevent unexpected operation and malfunction.

4. Contact SMC beforehand and take special consideration of safety measures if the product is to be used in any of the following conditions.

1. Conditions and environments outside of the given specifications, or use outdoors or in a place exposed to direct sunlight.

2. Installation on equipment in conjunction with atomic energy, railways, air navigation, space, shipping, vehicles, military, medical treatment, combustion and recreation, or equipment in contact with food and beverages, emergency stop circuits, clutch and brake circuits in press applications, safety equipment or other applications unsuitable for the standard specifications described in the product catalog.

3. An application which could have negative effects on people, property, or animals requiring special safety analysis.

4. Use in an interlock circuit, which requires the provision of double interlock for possible failure by using a mechanical protective function, and periodical checks to confirm proper operation.



Safety Instructions

Caution

1. The product is provided for use in manufacturing industries.

The product herein described is basically provided for peaceful use in manufacturing industries. If considering using the product in other industries, consult SMC beforehand and exchange specifications or a contract if necessary. If anything is unclear, contact your nearest sales branch.

Limited warranty and Disclaimer/Compliance Requirements

The product used is subject to the following "Limited warranty and Disclaimer" and "Compliance Requirements".

Read and accept them before using the product.

Limited warranty and Disclaimer

1. The warranty period of the product is 1 year in service or 1.5 years after the product is delivered, whichever is first.*2)

Also, the product may have specified durability, running distance or replacement parts. Please consult your nearest sales branch.

2. For any failure or damage reported within the warranty period which is clearly our responsibility, a replacement product or necessary parts will be provided.

This limited warranty applies only to our product independently, and not to any other damage incurred due to the failure of the product.

3. Prior to using SMC products, please read and understand the warranty terms and disclaimers noted in the specified catalog for the particular products.

***2) Vacuum pads are excluded from this 1 year warranty.**

A vacuum pad is a consumable part, so it is warranted for a year after it is delivered.

Also, even within the warranty period, the wear of a product due to the use of the vacuum pad or failure due to the deterioration of rubber material are not covered by the limited warranty.

Compliance Requirements

1. The use of SMC products with production equipment for the manufacture of weapons of mass destruction (WMD) or any other weapon is strictly prohibited.

2. The exports of SMC products or technology from one country to another are governed by the relevant security laws and regulation of the countries involved in the transaction. Prior to the shipment of a SMC product to another country, assure that all local rules governing that export are known and followed.

Caution

SMC products are not intended for use as instruments for legal metrology.

Products that SMC manufactures or sells are not measurement instruments that are qualified by pattern approval tests relating to the measurement laws of each country.

Therefore, SMC products cannot be used for business or certification ordained by the measurement laws of each country.

Operator

- ◆ This operation manual is intended for those who have knowledge of machinery using pneumatic equipment, and have sufficient knowledge of assembly, operation and maintenance of such equipment. Only those persons are allowed to perform assembly, operation and maintenance.
- ◆ Read and understand this operation manual carefully before assembling, operating or providing maintenance to the product.

■ Safety Instructions

Warning

- Do not disassemble, modify (including changing the printed circuit board) or repair.
An injury or failure can result.
- Do not operate the product outside of the specifications.
Do not use for flammable or harmful fluids.
Fire, malfunction, or damage to the product can result.
Verify the specifications before use.
- Do not operate in an atmosphere containing flammable or explosive gases.
Fire or an explosion can result.
This product is not designed to be explosion proof.
- Do not use the product in a place where static electricity is a problem.
Otherwise it can cause failure or malfunction of the system.
- If using the product in an interlocking circuit:
 - Provide a double interlocking system, for example a mechanical system
 - Check the product regularly for proper operationOtherwise malfunction can result, causing an accident.
- The following instructions must be followed during maintenance:
 - Turn off the power supply
 - Stop the air supply, exhaust the residual pressure and verify that the air is released before performing maintenanceOtherwise an injury can result.

Caution

- Do not touch the terminals and connectors while the power is on.
Otherwise electric shock, malfunction or damage to the product can result.
- After maintenance is complete, perform appropriate functional inspections and leak tests.
Stop operation if the equipment does not function properly or there is a leakage of fluid.
When leakage occurs from parts other than the piping, the product might be faulty.
Disconnect the power supply and stop the fluid supply.
Do not apply fluid under leaking conditions.
Safety cannot be assured in the case of unexpected malfunction.

■ NOTE

- Follow the instructions given below when designing, selecting and handling the product.
 - The instructions on design and selection (installation, wiring, environment, adjustment, operation, maintenance, etc.) described below must also be followed.
 - *Product specifications
 - Use the specified voltage.
Otherwise failure or malfunction can result.
 - Use the specified pressure sensor.
Otherwise the product may be broken and it will not be able to perform proper measurement.
 - Do not exceed the specified maximum allowable load.
Otherwise it can cause damage or shorten the lifetime of the product.
 - Design the product to prevent reverse current when the circuit is opened or the product is forced to operate for operational check.
Reverse current can cause malfunction or damage to the product.
 - Input data to the product is not deleted, even if the power supply is cut off.
(Writing time: 10,000 times, Data duration: 20 years after power off)
 - Reserve a space for maintenance.
Allow sufficient space for maintenance when designing the system.

●Product handling

*Installation

- Tighten to the specified tightening torque.

If the tightening torque is exceeded the mounting screws and brackets may be broken.

If the tightening torque is insufficient, the product can be displaced and loosen the mounting screws.

- Be sure to ground terminal FG when using a commercially available switch-mode power supply.
- Do not drop, hit or apply shock to the product.

Otherwise damage to the internal parts can result, causing malfunction.

- Do not pull the lead wire forcefully, not lift the product by pulling the lead wire.

(Tensile strength: 35 N maximum for lead wire with connector, 25 N maximum for sensor lead wire with connector.)

Hold the body when handling to avoid the damage of the product which lead to cause the failure and malfunction.

*Wiring

- Do not pull the lead wires. In particular, do not lift or carry the product by holding the cables once they are connected to the product.

Otherwise damage to the internal parts can result, causing malfunction or to be off the connector.

- Avoid repeatedly bending or stretching the lead wire, or placing heavy load on them.

If the lead wire can move, fix it near the body of the product.

The recommended bend radius of the lead wire is 6 times the outside diameter of the sheath, or 33 times the outside diameter of the insulation material, whichever is larger.

Replace the damaged lead wire with a new one.

- Wire correctly.

Incorrect wiring can break the product.

- Do not perform wiring while the power is on.

Otherwise damage to the internal parts can result, causing malfunction.

- Do not route wires and cables together with power or high voltage cables.

Otherwise the product can malfunction due to interference of noise and surge voltage from power and high voltage cables to the signal line. Route the wires (piping) of the product separately from power or high voltage cables.

- Confirm proper insulation of wiring.

Poor insulation (interference from another circuit, poor insulation between terminals, etc.) can lead to excess voltage or current being applied to the product, causing damage.

- Design the system to prevent reverse current when the product is forced to operate for operational check.

Depending on the circuit used, insulation may not be maintained when operation is forced, allowing reverse current to flow, which can cause malfunction and damage the product.

- Keep wiring as short as possible to prevent interference from electromagnetic noise and surge voltage.

Do not use a cable longer than 30 m.

Wire the DC(-) line(blue) as close as possible to the power supply.

*Environment

- Do not use the product in area that is exposed to corrosive gases, chemicals, sea water, water or steam.

Otherwise failure or malfunction can result.

- Do not use the product in an environment where the product is constantly exposed to water or oil splashes.

If the product is to be used in an environment containing oils or chemicals such as coolant or cleaning solvent, it may be adversely affected (damage, malfunction, or hardening of the lead wires).

- Do not use in an area where surges are generated.

If there is equipment which generates a large amount of surge (solenoid type lifter, high frequency induction furnace, motor, etc.) close to the product, this may cause deterioration or breakage of the internal circuit of the product. Avoid sources of surge generation and crossed lines.

- Do not use a load which generates surge voltage.
When a surge-generating load such as a relay or solenoid is driven directly, use a product with a built-in surge absorbing element.
- The product is CE marked, but not immune to lightning strikes. Take measures against lightning strikes in the system.
- Mount the product in a place that is not exposed to vibration or impact.
Otherwise failure or malfunction can result.
- Prevent foreign matter such as remnant of wires from entering the product.
Take proper measures for the remnant not to enter the product in order to prevent failure or malfunction.
- Do not use the product in an environment that is exposed to temperature cycle.
Heat cycles other than ordinary changes in temperature can adversely affect the inside of the product.
- Do not expose the product to direct sunlight.
If using in a location directly exposed to sunlight, shade the product from the sunlight.
Otherwise failure or malfunction can result.
- Keep within the specified ambient temperature range.
The ambient temperature range is 0 to 50°C. Operation at low temperature (5°C or less) may cause damage or operation failure due to frozen moisture in the air.
Protection against freezing is necessary.
Avoid sudden temperature change even within specified temperature.
- Do not operate close to a heat source, or in a location exposed to radiant heat.
Otherwise malfunction can result.

*Adjustment and Operation

- Turn the power on after connecting a load.
Otherwise it can cause excess current causing instantaneous breakage of the product.
- Do not short-circuit the load.
Although error is displayed when the load at the output part has a short circuit, generated over current may lead to the damage of the product.
- Do not press the setting buttons with a sharp pointed object.
It may damage the setting buttons.
- If using the product to detect very small pressure rates, warm up the product for 10 to 15 minutes first.
There will be a drift on the display of approximate $\pm 1\%$ immediately after the power supply is turned on, within 10 minutes.
- Perform settings suitable for the operating conditions.
Incorrect setting can cause operation failure.
For details of each setting, refer to page 19 to 69 of this manual.
- Do not touch the LCD during operation.
The display can vary due to static electricity.

*Maintenance

- Turn OFF the power supply before maintenance.
There is a risk of unexpected malfunction.
- Perform regular maintenance and inspections.
There is a risk of unexpected malfunction.
- Do not use solvents such as benzene, thinner etc. to clean the product.
They could damage the surface of the body and erase the markings on the body.
Use a soft cloth to remove stains. For heavy stains, use a cloth soaked with diluted neutral detergent and fully squeezed, then wipe up the stains again with a dry cloth.

Model Indication and How to Order

PSE3 0 0 A-

Input specification

Symbol	Content
0	Voltage input
1	Current input

Output specification

Symbol	Content
0	NPN 2 outputs ^{*1} + analogue voltage ^{*2}
1	NPN 2 outputs ^{*1} + analogue current ^{*2}
3	PNP 2 outputs ^{*1} + analogue voltage ^{*2}
4	PNP 2 outputs ^{*1} + analogue current ^{*2}
6	NPN 2 outputs ^{*1} + copy function

*1: NPN or PNP switching type.

*2: Analogue output, auto-shift input and copy function switching type.

Unit specification

Symbol	Content
Nil	With units selection function ^{*1}
M	Fixed SI unit ^{*2}

*1: The new Measurement Law prohibits the use of pressure switch with the units selection function in Japan.

A unit label is attached.

*2: Fixed unit kPa, MPa, Pa

Option 3

Symbol	Content
Nil	No option
C	Connector for sensor lead wire

Option 2

Symbol	Content
Nil	No option
A	Bracket
B	Panel mount adapter
D	Panel mount adapter + Front protective cover

Option 1

Symbol	Content
Nil	No option
L	Lead wire with connector (lead wire length 2 m)

○Accessories/Part numbers

If an option is required independently, order with the following part numbers.

Items	Part No.	Remarks
Bracket	ZS-46-A1	Self tapping screws: Nominal size 3 x 8L (2 pcs.)
Panel mount adapter	ZS-46-B	-
Panel mount adapter + Front protective cover	ZS-46-D	-
Front protective cover	ZS-27-01	-
Lead wire with connector	ZS-46-5L	5-wire, 2 m
Connector for sensor lead wire	ZS-28-C	-

Summary of Product parts

Names of individual parts

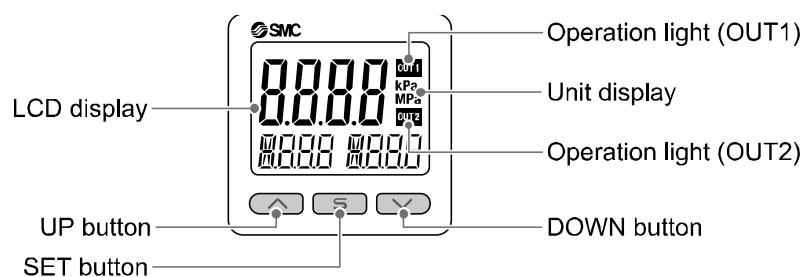

Operation light: Displays the switch operating condition.

LCD display: Displays the current status of pressure, setting mode, selected display units and error code.
4 types of display can be selected for the main display: Single colour of constant red or green;
or switching from red to green or green to red corresponding to the output.
The indication for the sub display is orange.

UP button: Increases mode and ON/OFF set values.

DOWN button: Decreases mode and ON/OFF set values.

SET button: Press this button to change mode and to confirm settings.

Unit display: Indicates the units currently selected. (Only for display units of kPa and MPa)

■ Definition and terminology

	Term	Definition
A	Auto-preset	Performs pressure setting automatically by detecting the increase and decrease in pressure. For example, if this function is used for a suction test, the pressure setting will be completed by performing suction and release of the workpiece.
B	Bottom value display (mode)	Shows the minimum pressure from when the power was supplied to the current time.
C	Chattering	The problem of the switch output turning ON and OFF repeatedly around the set value at high frequency due to the effect of pulsation.
	Chattering prevention function	A function to delay the response time of switch output in order to prevent chattering.
	Copy destination Pressure switch	A Pressure switch whose settings are copied to when using the copy function.
	Copy function	A function to copy a pressure setting value and function setting (Excludes finely adjusted displayed values and line names.).
	Copy source sensor monitor	A sensor monitor whose settings are copied when using the copy function.
D	Delay time	The setting time from when the signal of the connected pressure sensor reaches the set value, to when the ON-OFF output actually begins working. Delay time setting can prevent the output from chattering.
	digit (Minimum setting unit)	Shows how precisely the pressure can be displayed or set. When 1 digit = 1 kPa, the pressure is displayed in increments of 1 kPa, e.g., 1, 2, 3, ..., 99, 100.
	Digital filter	Function to add digital filtering to the fluctuation in the input signal. Smooth the fluctuation of displayed value for sharp start up or fall of the pressure. When the function is used, digital filtering is reflected in the switch output ON/OFF or analogue response time. Output chattering or flicker in the measurement mode display can be reduced by setting the digital filter. The response time indicates when the set value is 90% in relation to the step input.
	Display accuracy	Shows The maximum deviation between the displayed pressure value and the true pressure.
	Display colour	Indicates the colour of the number of digital display. Always green, always red, green (switch OFF) → red (switch ON), red (switch OFF) → green (switch ON) are available.
	Display resolving power	Indicate in how many the rated pressure range can be divided to display. (Example: When the value can be displayed down to 0.001 MPa for the product for 0 to 1 MPa, the resolution is 1/1000)
	Display value fine adjustment (function)	Displayed pressure value can be adjusted within the range of $\pm 5\%$ R.D. ($\pm 5\%$ of displayed value). It is used if the true pressure value is known, or to eliminate differences between the displayed values of different instruments that are measuring the same pressure.
E	Error output	Switches the switch output to ON/OFF when an error is displayed. Refer to "List of output modes" on page 36 for operating conditions. Refer to "Error indication function" on page 77 for details of the errors.
	Error displayed	The code number displayed, identifying the error detected by the self-diagnosis function of the product. Refer to "Error indication function" on page 77 for details of the errors.

	Term	Definition
F	Fine adjustment mode	Refer to "Display value fine adjustment (function)".
	F.S. (full span/full scale)	Abbreviation of full span and full scale; difference between the minimum and maximum rated pressure values. means the maximum fluctuation range of the product rated value. For example, when the rated pressure range is -0.100 to 1.000 [MPa]: F.S. = 1.000 - (-0.100) = 1.100 [MPa] (Reference: 1%F.S. = 1.100 x 0.01 = 0.011 [MPa])
	Function selection mode	A mode in which setting of functions is performed. It is a separate menu from the pressure setting. If any function settings need to be changed from the factory default, each setting can be selected with "F*". The setting items are: display colour, pressure range, pressure unit, operation mode, output type, digital filter, display resolution, display value fine adjustment, use of auto preset, use of power saving mode, security code, etc.
H	Hysteresis	Difference between the points at which the product is turned ON and OFF.
	Hysteresis mode	Refer to the "List of output modes" on page 36.
I	Insulation resistance	Insulation resistance of the product. The resistance between the electrical circuit and the case.
K	Key-lock function	Function that prevents changes to the settings of the product (disables button operation).
M	Manual setting	Manual pressure setup without using auto preset. This term is used to distinguish between manual and auto preset pressure setup.
	Maximum applied voltage	The maximum voltage that can be connected to the output (output line) of an NPN device.
	Maximum load current	The maximum current that can flow to the output (output line) of the switch output.
	Measurement mode	Operating condition in which pressure is being detected and displayed, and the switch function is working.
	Minimum setting unit	Refer to "digit".
N	Normal output	One of the switch output types. In hysteresis mode the switch output is turned ON when pressure equal to or greater than the switch output set value is detected. In window comparator mode, the switch output is turned ON when pressure between the switch output set values (P1L to P1H) is detected. (Refer to the "List of output modes" on page 36)
O	Operation light	A light that turns on when the switch output is ON.
	Output impedance	The resistance value of a component between the voltage output element and the analog voltage output. It is indicated as a resistance value which is converted in accordance with the condition in which resistance is directly connected to the voltage output element. There may be an error in the output voltage depending on this output impedance and the input impedance of customers' equipment. (example: If the Pressure switch with output impedance of 1 kΩ is connected to the A/D converter to detect the analogue output of 5 V, the detected voltage by the A/D converter becomes $5 (V) \times 1 (M\Omega) / (1 (k\Omega) + 1 (M\Omega)) \approx 4.995 (V)$, and there is an error of approximate 0.005 V).
	Operation mode	Either hysteresis mode or window comparator mode can be selected.
	Output style	The operation principle of the switch output. Normal output and reverse output can be selected. Please refer to the "List of output modes" on page 36 operating conditions.

	Term	Definition
P	Peak value display (mode)	Shows the maximum pressure from when the power was supplied to the current time.
	Power saving mode	Operating mode in which the digital display turns off and power consumption is reduced.
	Pressure setting	The set pressure value that determines the point at which the product turns ON and OFF.
R	Rated pressure range	The pressure range within which the product will meet all published specifications. Values outside of this range can be set as long as they are within the set pressure range, but the specifications cannot be guaranteed.
	R.D.	Current read value For example, when the display value is 1.000[MPa], $\pm 5\%$ R.D. is $\pm 5\%$ of 1.000 [MPa], which becomes ± 0.05 [MPa]. When the display value is 0.800 [MPa], $\pm 5\%$ R.D. is $\pm 5\%$ of 0.800 [MPa], which becomes ± 0.04 [MPa].
	Repeatability	Variation in repeated measurement of pressure display or ON-OFF output point when the pressure changes at 25 centigrade.
	Residual voltage	The difference between the ideal ON voltage and the actual voltage when the switch output is on. Varies with load current. Ideally should be 0 V.
	Resolution	Refer to "Display resolution".
	Reversed output	One of the switch output types. In hysteresis mode the switch output is turned ON when pressure less than or equal to the switch output set value is detected. In window comparator mode, the switch output is turned ON when pressure is outside the switch output set values (n1L to n1H) is detected. (Refer to the "List of output modes" on page 36)
	Ripple	A type of chattering.
S	Set pressure range	The pressure range that can be set for switch output.
	Switch output	Sometimes referred to as "ON-OFF output".
U	Units selection function	A function to change the units in which the measured pressure value is displayed. The display units can only be changed if the product is equipped this function. It is not possible to purchase the product with this function if the product is used in Japan. The product for Japan is displayed in SI only.
W	Window comparator mode	An operating mode in which the switch output is turned on and off depending on whether the flow is inside or outside the range of two set values. (Refer to the "List of output modes" on page 36)
	Withstand voltage	A measure of the product's resistance to a voltage applied between the electrical circuit and case. Durability in withstanding voltage. The product may be damaged if a voltage over this value is applied. (The withstand voltage is not the supply voltage used to power the product.)
Z	Zero-clear function	This function to adjust the displayed pressure to zero.

Mounting and Installation

■ Installation

○ Mounting with bracket

- Mount the bracket to the body with mounting screws (Self tapping screws: Nominal size 3 x 8L (2 pcs)), then set the body to the specified position.

*: Tighten the bracket mounting screws to a torque of 0.5 ± 0.05 N•m.

Self tapping screws are used, and should not be re-used several times.

- Bracket (Part No.: ZS-46-A1)

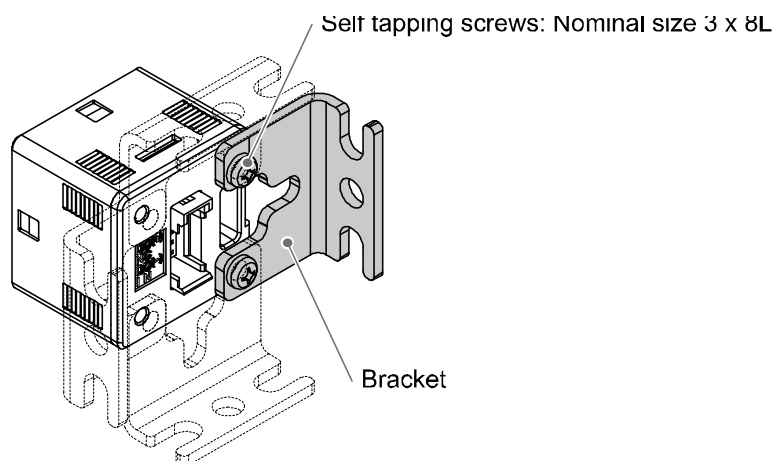

○ Mounting with panel mount adapter

● Mount part (a) to the front of the body and fix it. Then insert the body with (a) into the panel until (a) comes into contact with the panel front surface. Next, mount part (b) to the body from the rear and insert it until (b) comes into contact with the panel for fixing.

● Panel mount adapter (Part No.: ZS-46-B)

Panel mount adapter + Front protective cover (Part No.: ZS-46-D)

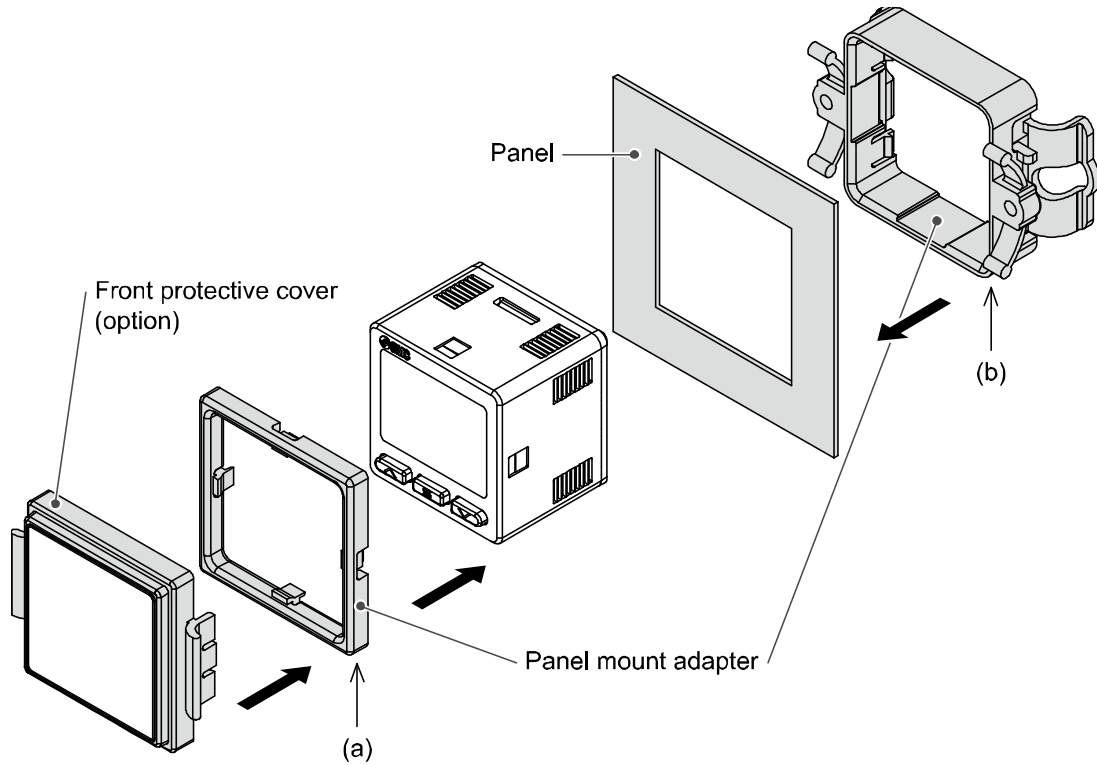

*: The panel mount adapter can be rotated through 90 degrees for mounting.

How to remove the panel mount adapter

● When removing the digital flow switch with panel mount adapter from the installation, pull it forward while expanding the hooks on each side as shown below. If the panel mount adapter is pulled forward with the hook caught, the product and the adapter may be damaged.

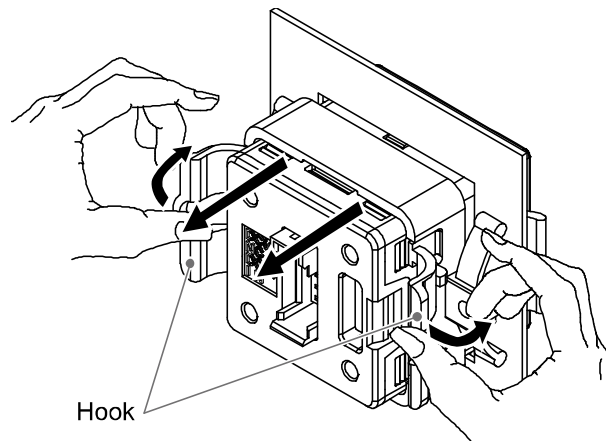

■Wiring

○Wiring connections

- Connections should be made with the power supply turned off.
- Use a separate route for the product wiring and any power or high voltage wiring. Otherwise, malfunction may result due to noise.
- If a commercially available switching power supply is used, be sure to ground the frame ground (FG) terminal. If the switching power supply is connected for use, switching noise will be superimposed and it will not be able to meet the product specifications. In that case, insert a noise filter such as a line noise filter/ferrite between the switching power supplies or change the switching power supply to the series power supply.

○How to use connector

Connector attachment/detachment

- When connecting the connector, insert it straight onto the pins, holding the lever and connector body, and lock the connector by pushing the lever hook into the concave groove on the housing.
- To detach the connector, remove the hook from the groove by pressing the lever downward, and pull the connector straight out.

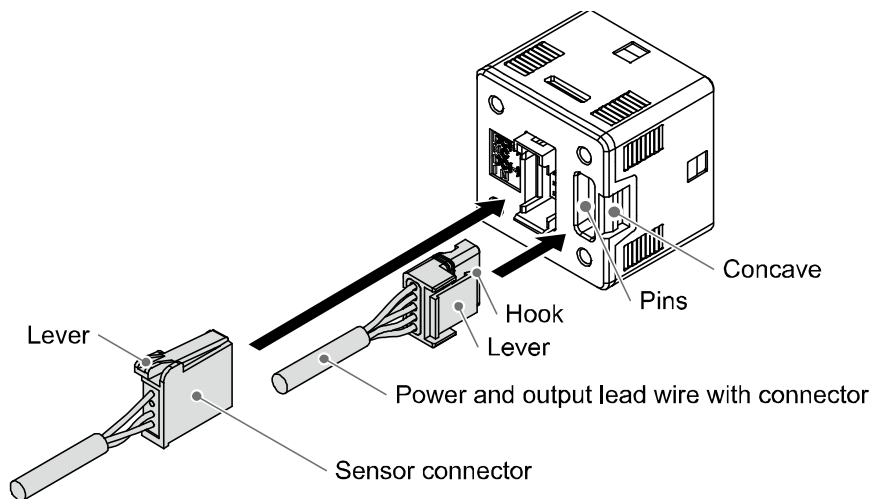

Connector pin out

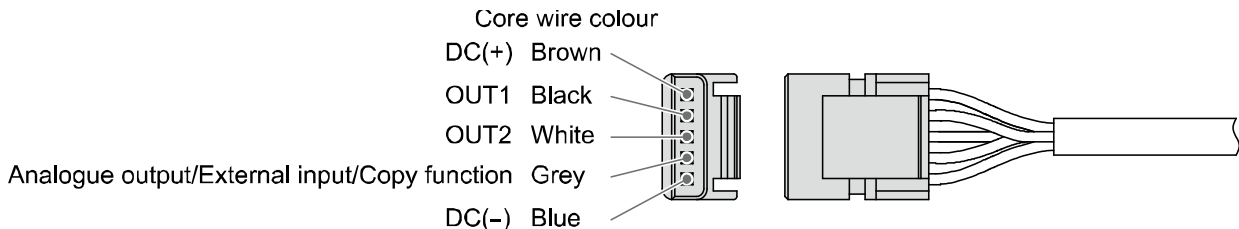

○Attaching the connector to the lead wire

- Sensor wire is stripped as shown in the right figure.
(Refer to the table below for correspondence between connector and electrical wire gauge.)

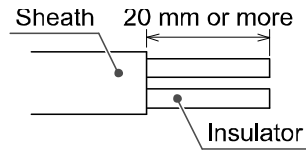

Lead wire table

AWG No.	Conductor size (mm ²)	Overall diameter (mm)	Colour of cover	SMC product No. (1 pc.)
26-24 (28)	0.14-0.2 (0.08)	φ0.8 to φ1.0	Red	ZS-28-C
		φ1.0 to φ1.2	Yellow	ZS-28-C-1
		φ1.2 to φ1.6	Orange	ZS-28-C-2
22-20	0.3-0.5	φ1.0 to φ1.2	Green	ZS-28-C-3
		φ1.2 to φ1.6	Blue	ZS-28-C-4
		φ1.6 to φ2.0	Gray	ZS-28-C-5

- Do not cut the insulator.
- The core of the corresponding colour shown in the following table is put into the pin of the number stamped on the connector for sensor connection to the back.

Number stamped on connector	Colour of cable core		
	PSE30#A (Voltage input)	PSE31#A (Current input)	
		Pressure sensor 2-wire type	Pressure sensor 3-wire type
1	Brown (DC(+))	Brown (LINE(+))	Brown (DC(+))
2	N.C.	N.C.	N.C.
3	Blue (DC(-))	N.C.	Blue (DC(-))
4	Black (OUT: 1 to 5 V)	Blue (LINE(-))	Black (OUT: 4 to 20 mA)

- Check that the above-mentioned preparation work has been performed correctly, and part A shown in the figure is pushed by hand and makes temporary connection.

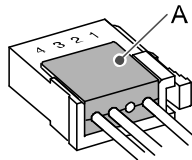

- Part A center is pushed straight in using a suitable tool, such as pliers.

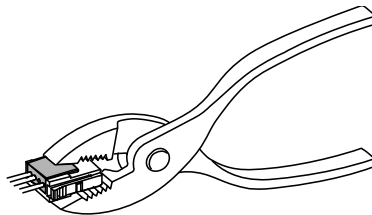

- Re-use cannot be performed once it connects the connector for sensor connection completely. When the connection fails or a pin is miswired, please use a new connector for sensor connection.
- When the sensor is not connected correctly, [LLL] will be displayed.
- Cable wire colour is applicable when an SMC sensor with lead wire is used.

Internal circuit and wiring example

NPN (2 outputs) + copy function setting

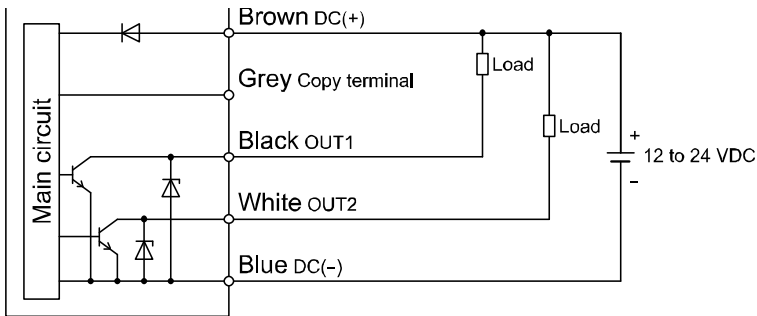

PNP (2 outputs) + copy function setting

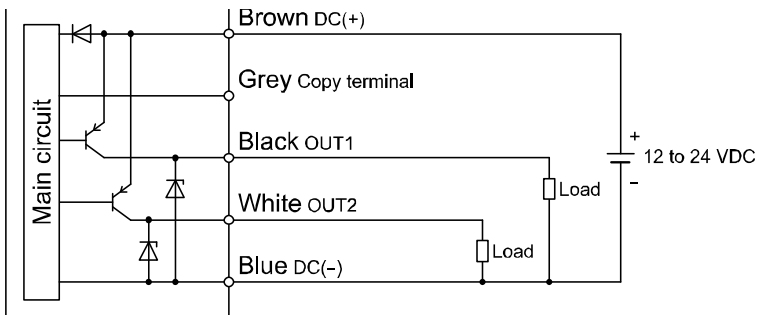

NPN (2 outputs) + analogue voltage output setting
NPN (2 outputs) + analogue current output setting

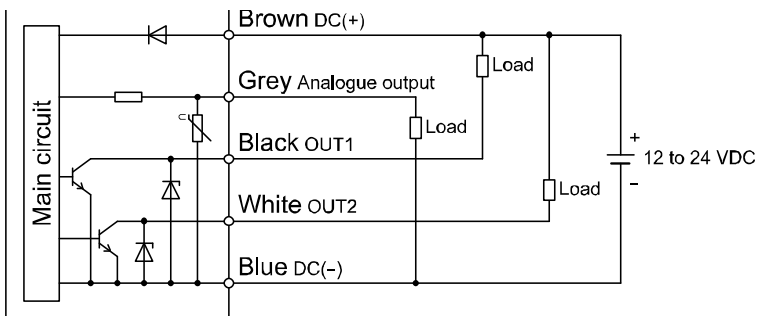

PNP (2 outputs) + analogue voltage output setting
PNP (2 outputs) + analogue current output setting

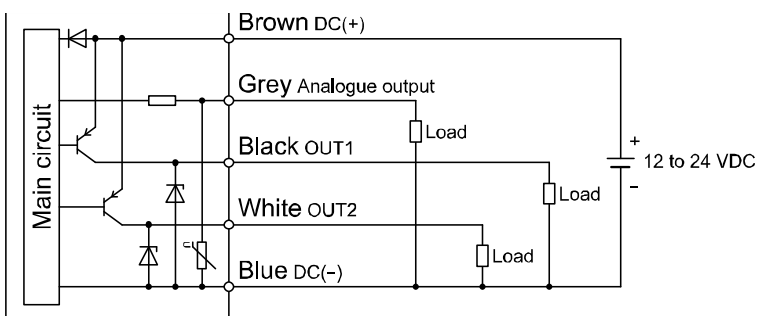

NPN (2 outputs) + auto-shift input setting

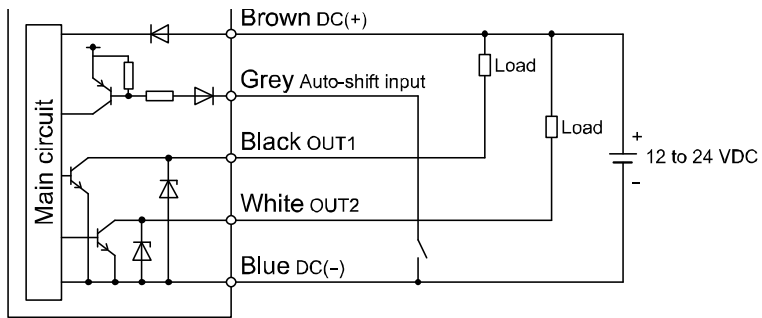

PNP (2 outputs) + auto-shift input setting

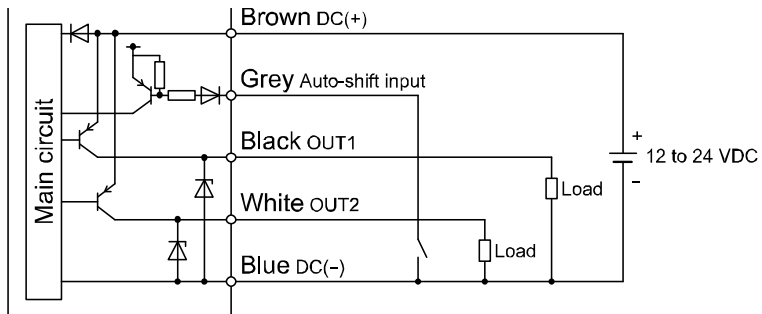

Pressure Setting

Default settings

When the pressure exceeds the set value, the switch will be turned on.

When the pressure falls below the set value by the amount of hysteresis or more, the switch will be turned off.

The default setting is that the output is turned ON at -50.5 kPa when the pressure range of the connected sensor is vacuum pressure.

Perform initial setting by referring to the setting outline (page 20).

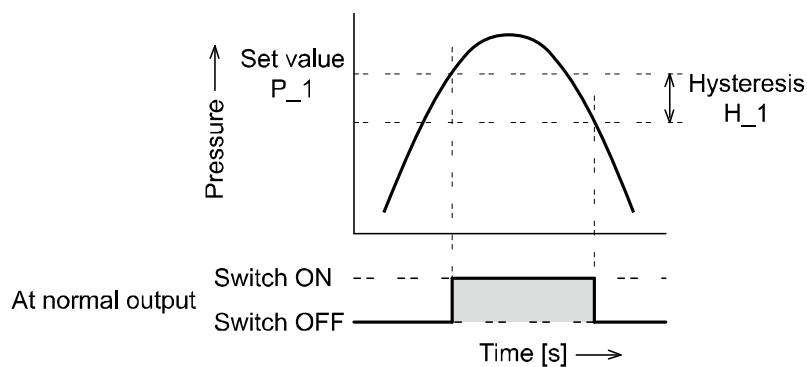

Outline of Settings

Power is supplied



The product code is displayed for approximately 3 sec. after supplying power.
After that, measurement mode is displayed.

*: Within approximately 0.2 second after power-on, the switch starts.



[Initial Setting] (Refer to page 21)

Set the pressure range, display unit and switch output NPN/PNP specification.



[Measurement mode]

Detects the pressure after power is supplied, and indicates the display and switch operating status. This is the basic mode; other modes should be selected for set-point changes and other function settings.

Measurement mode screen

Current pressure value (Main display)

Item (Sub display (left))

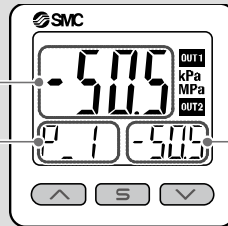

Set value or peak/bottom value (Sub display (right))

Sub display

In measurement mode, the display of the sub display can be temporarily changed by pressing the UP or DOWN buttons.

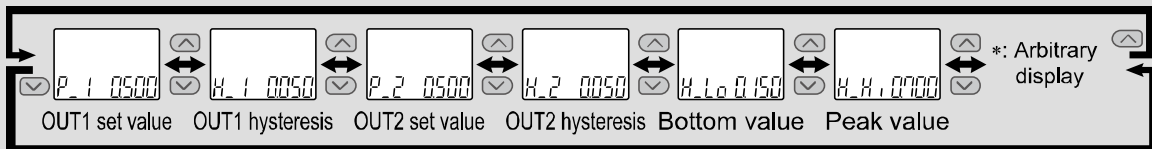

*: One arbitrary display mode can be added to the sub display by setting the [F10] sub display setting.

If the sub display is switched during the arbitrary display setting, the display will be returned to the arbitrary display 30 seconds later. (The default setting does not include arbitrary display.)

Press the SET button once.

Press the SET button between 1 and 3 sec.

Press the SET button between 3 and 5 sec.



[3 step setting mode]

Set either of set value or hysteresis. (Refer to page 24)

[Simple setting mode]

Select the set value, hysteresis and delay time. (Refer to page 26)

[Function selection mode]

Change the function settings. (Refer to page 28)

[Other Settings]

- Zero-clear function
- Key-lock function (Refer to page 66)

*: The outputs will continue to operate during setting.

*: If a button operation is not performed for a certain time during the setting, the display will flash. (This is to prevent the setting from remaining incomplete if, for instance, an operator were to leave during setting.)

*: 3 step setting mode, simple setting mode and function selection mode settings are reflected each other.

Initial Setting

Set the pressure range, display unit and NPN/PNP output specifications.

Measurement mode

↓ Press the SET button between 3 and 5 seconds.

[F 0] Display the switching function of the pressure range, display unit and switch output specifications.



Press the SET button. ↓ Move on to pressure range setting.

Pressure range setting

Press the UP or DOWN button to select pressure range.

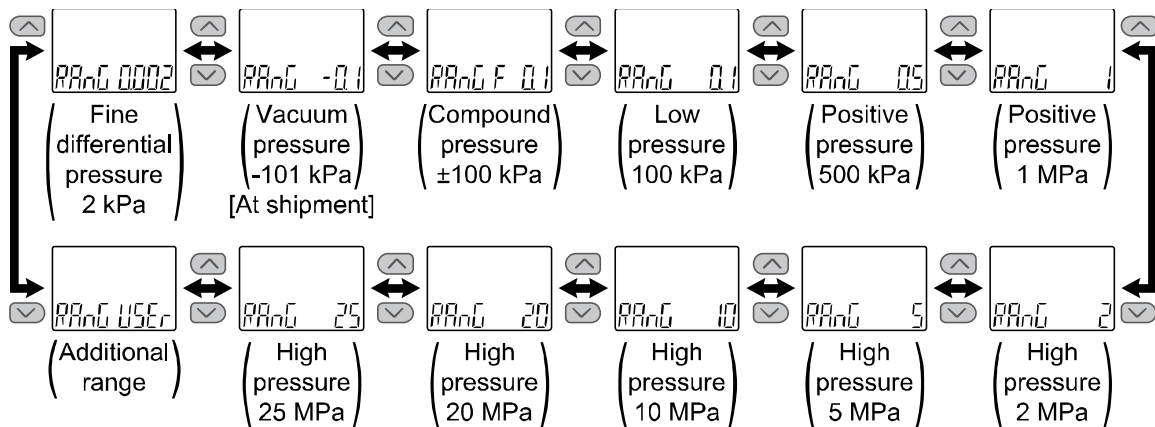

↓ [USEr] is selected.
Press the SET button to move on to the setting of the minimum unit of the additional range.

Additional range minimum unit setting

Press the UP or DOWN button to select the minimum unit.

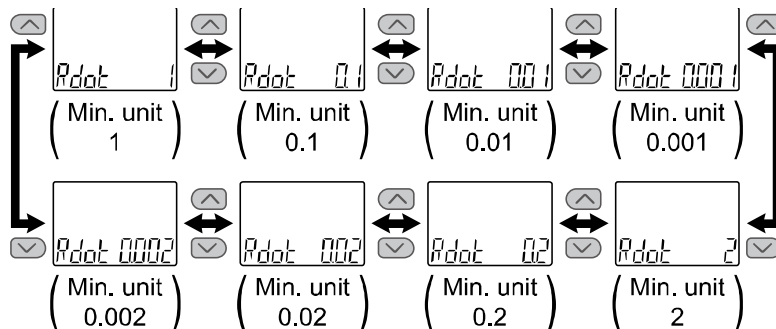

Press the SET button to set. ↓ Move on to the setting of the lower limit of the additional rated range.
The lower limit of the rated range is the displayed value when the sensor input signal is 0%.

Other than [USEr] is selected.
Press the SET button to move on to display unit setting.



Setting of the lower limit of the additional rated range

Press the UP or DOWN button to change the value.
 Press the button continuously to keep changing the value.
 Set the value that is required to be displayed when the sensor input signal is 0%.
 The setting range is -1500 to 1500 digit.

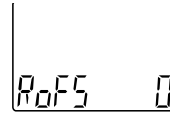

Press the SET button to set.



Move on to the setting of the upper limit of the additional rated range.
 The upper limit of the rated range is the displayed value when the sensor input signal is 100%.

Setting of the upper limit of the additional rated range

Press the UP or DOWN button to change the value.
 Press the button continuously to keep changing the value.
 Set the value that is required to be displayed when the sensor input signal is 100%.
 The setting range is -1500 to 1500 digit.



Press the SET button to set. Move on to display unit setting.

Display unit setting

Press the UP or DOWN button to select the display unit.

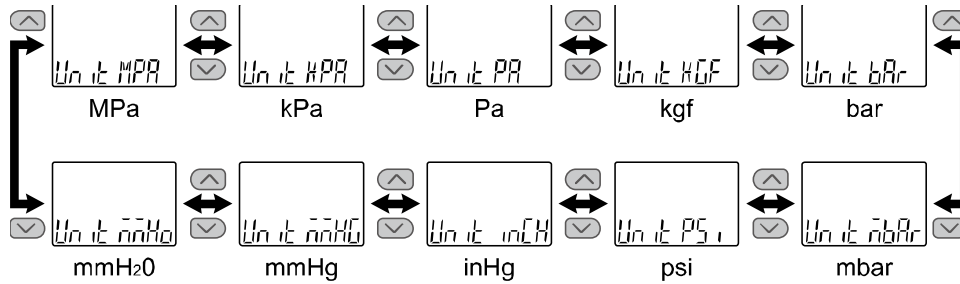
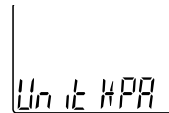

*: The unit that can be displayed is different depending on the pressure range. (Refer to page 30)
 (kPa/MPa/Pa can still be selected if the product does not have the units selection function.)

Press the SET button to set.



Move on to the switch output NPN/PNP specification switching setting.



Switching setting of switch output NPN/PNP specifications

The switch output of this product can be switched to NPN or PNP output in accordance with the user device construction.

Press the UP or DOWN button to select switch output specification.

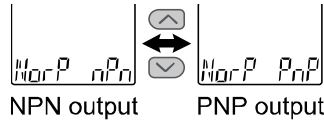

Press the SET button to set.  Return to function selection mode.

[F 0] Setting of the switching function of the pressure range, display unit and switch output specifications is completed.



Press the SET button for 2 second or longer.

Measurement mode
(Initial setting is completed)



Perform the setting with the 3 step setting mode, simple setting mode and function selection mode.

3 Step Setting Mode

3 step setting mode

In this mode, the set values can be input in just 3 steps.

Use this mode if the product is to be used straight away, after changing only the set values.

(The current pressure value is displayed on the main display.)

<Operation>

[3 step setting mode (hysteresis mode)]

In the 3 step setting mode, the set value (P_1 or n_1, P_2 or n_2) and hysteresis (H_1, H_2) can be changed. Set the items on the sub display (set value or hysteresis) with UP or DOWN button. When changing the set value, follow the operation below. The hysteresis setting can be changed in the same way.

- (1) Press the SET button once when the item to be changed is displayed on the sub display.
The set value on the sub display (right) will start flashing.

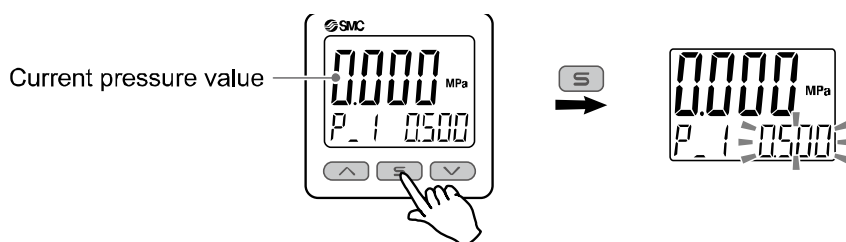

- (2) Press the UP or DOWN button to change the set value.
The set value can be increased with UP button and can be reduced with DOWN button.

• Press the UP button once to increase the value by one digit, press and hold to continuously increase.

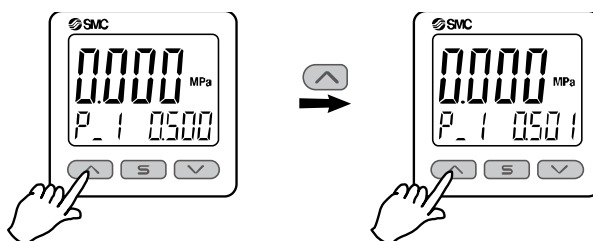

• Press the DOWN button once to reduce the value by one digit, press and hold to continuously reduce.

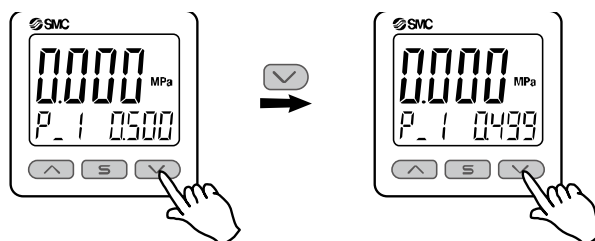

• When the UP and DOWN buttons are pressed and held simultaneously for 1 second or longer, the set value is displayed as [- -], and the set value will be the same as the current pressure value automatically (snap shot function (Refer to page 66)). Afterwards, it is possible to adjust the value by pressing the UP or DOWN button.

- (3) Press the SET button to complete the setting.

The product turns on within a set pressure range (OUT1: from P1L to P1H, OUT2: from P2L to P2H) during window comparator mode. Set P1L/P2L, the lower limit of the switch operation, and P1H/P2H, the upper limit of the switch operation and WH1/WH2 (hysteresis) following the instructions given on page 24. (When reversed output is selected, the sub display (left) shows [n1L]/[n2L] and [n1H]/[n2H].) Please refer to the "List of output modes" on page 36 for the relationship between the set values and operation.

*: Setting of the normal/reverse output switching and hysteresis/window comparator mode switching are performed with the function selection mode [F 1] Setting of OUT1, [F 2] Setting of OUT2.

Simple Setting Mode

<Operation>

[Simple setting mode (hysteresis mode)]

In the simple setting mode, the set value, hysteresis and delay time can be changed while checking the current pressure value (main display).

- (1) Press and hold the SET button between 1 and 3 seconds in measurement mode. [SEt] is displayed on the main display. When the button is released while in the [SEt] display, the current pressure value is displayed on the main display, [P_1] or [n_1] is displayed on the sub display (left), and the set value is displayed on the sub display (right) (Flashing).

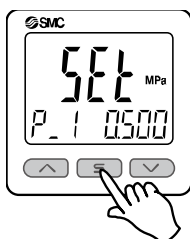

- (2) Change the set value with UP or DOWN button, and press the SET button to set the value. Then, the setting moves to hysteresis setting. (The snap shot function can be used. (Refer to page 66))

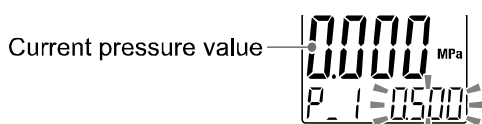

- (3) Change the set value with UP or DOWN button, and press the SET button to set the value. Then, the setting moves to the delay time of the switch output. (The snap shot function can be used. (Refer to page 66))



- (4) Press the UP or DOWN button, the delay time of the switch output can be selected. Delay time setting can prevent the output from chattering.

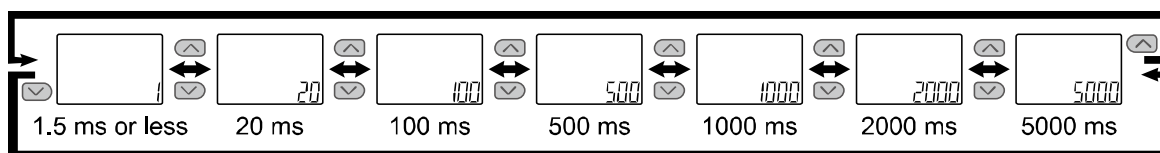

- (5) Press the SET button for 2 seconds or less to complete the OUT1 setting. [P_2] or [n_2] is displayed on the sub screen (left). Continue with setting the OUT2. Press and hold the SET button for 2 seconds or longer to complete the setting. The product will return to measurement mode.

*1: Selected items (1) to (4) become valid after pressing the SET button.

*2: After enabling the setting by pressing the SET button, it is possible to return to measurement mode by pressing the SET button for 2 seconds or longer.

*3: When the output mode (refer to page 34) is set to error output or switch output OFF, the simple setting mode cannot be used.

In the window comparator mode, set P1L/P2L, the lower limit of the switch operation, and P1H/P2H, the upper limit of the switch operation, WH1/WH2 (hysteresis) and dt1/dt2 (delay time) following the instructions given on page 26.

(When reversed output is selected, the sub display (left) shows [n1L]/[n2L] and [n1H]/[n2H].)

Please refer to the "List of output modes" on page 36 for the relationship between the set values and operation.

Function Selection Mode

■ Function selection mode

In measurement mode, press the SET button between 3 and 5 seconds, to display [F 0]. Select to display the function to be changed [F□□]. Press and hold the SET button for 2 seconds or longer in function selection mode to return to measurement mode.

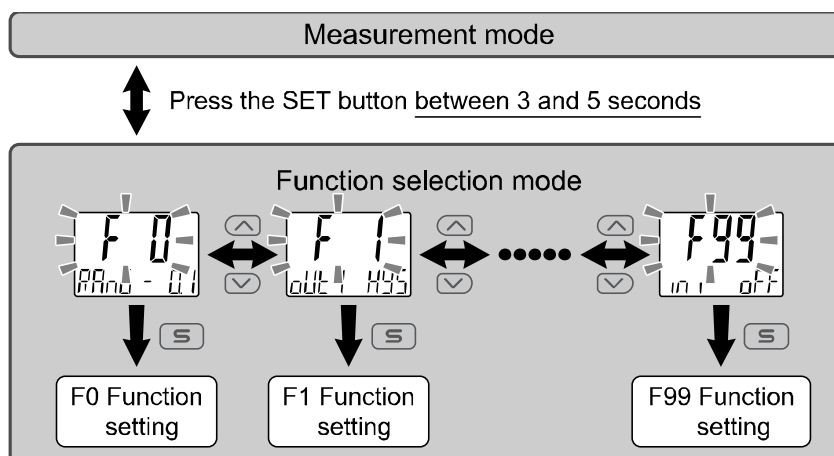

*: Some products do not have all the functions. If no function is available or selected due to configuration of other functions, [- -] is displayed on the sub display (right).

■ Default setting

The default setting is as follows.

If no problem is caused by this setting, keep these settings.

To change a setting, enter function selection mode.

- Switching function of [F 0] Pressure range, display unit and switch output specifications ➡ Page 30

Item	Default setting
Connected sensor range	-101 kPa
Display units	kPa
Switch output specifications	NPN/PNP *

*: Depends on part number.

- [F 1] Setting of OUT1 ➡ Page 34

Item	Explanation	Default setting
Output mode	Either hysteresis mode, window comparator mode, error output or switch output OFF can be selected.	Hysteresis mode
Reversed output	Selects which type of switch output is used, normal or reversed.	Normal output
Pressure setting	Sets the ON and OFF point of the switch output.	-50.5 kPa
Hysteresis	Appropriate setting of the hysteresis will prevent the switch output from chattering.	5.1 kPa
Delay time	Delay time of the switch output can be selected.	1.5 ms or less
Display colour	Select the display colour.	Output ON : Green Output OFF: Red (Linked to OUT1)

•[F 2] Setting of OUT2 ➡ Page 37

Item	Explanation	Default setting
Output mode	Either hysteresis mode, window comparator mode, error output or switch output OFF can be selected.	Hysteresis mode
Reversed output	Selects which type of switch output is used, normal or reversed.	Normal output
Pressure setting	Sets the ON and OFF point of the switch output.	-50.5 kPa
Hysteresis	Appropriate setting of the hysteresis will prevent the switch output from chattering.	5.1 kPa
Delay time	Delay time of the switch output can be selected.	1.5 ms or less
Display colour	Select the display colour.	Output ON : Green Output OFF: Red (Linked to OUT1)

•Other parameter settings

Item	Page	Default setting
[F 3] Digital filter setting	Page 39	0 ms
[F 4] Auto-preset function	Page 40	Not used
[F 5] FUNC terminal setting *1	Page 42	Analogue output: 1 to 5 V/4 to 20mA
[F 6] Fine adjustment of display value	Page 46	0%
[F10] Sub display setting	Page 47	std (Standard)
[F11] Display resolution setting	Page 53	1000-split
[F80] Power saving mode	Page 54	OFF
[F81] Security code	Page 55	OFF
[F82] Input of line name	Page 57	AAAA
[F90] Setting of all functions	Page 58	OFF
[F96] Input signal check	Page 60	No configurable items
[F97] Selection of copy check	Page 61	No configurable items
[F98] Output check	Page 63	N/A (normal output)
[F99] Reset to default settings	Page 65	OFF

*1: This function is available for models with analogue output.

*2: When "6" is specified for the output type, the function is copy input.

■[F 0] Switching function of pressure range, display unit and switch output specifications

Pressure range setting

Pressure range that matches with the connected sensor can be selected.
In addition, the required range can be set and displayed. (Additional range)



•Relation between analog input and digital display

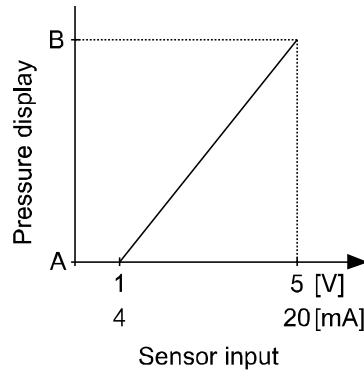

Set value	A	B
0.002	0 kPa	2 kPa
-0.1	0 kPa	-101 kPa
F0.1	-100 kPa	100 kPa
0.1	0 kPa	100 kPa
0.5	0 kPa	500 kPa
1	0 MPa	1 MPa
2	0 MPa	2 MPa
5	0 MPa	5 MPa
10	0 MPa	10 MPa
20	0 MPa	20 MPa
25	0 MPa	25 MPa
USER	Input value (setting)	Input value (setting)

•Available display unit and minimum set value

Pressure range	Rated pressure	Display	MPa	kPa	Pa	Kgf/cm ²	bar	mbar	psi	inHg	mmHg	mmH ₂ O
Fine differential pressure	2 kPa	0.002	-	0.001	1	-	-	0.01	0.001	-	-	0.1
Vacuum	-101 kPa	-0.1	0.001	0.1	-	0.001	0.001	-	0.01	0.1	1	-
Compound	±100 kPa	F0.1	0.001	0.1	-	0.001	0.001	-	0.02	0.1	1	-
Low pressure	100 kPa	0.1	0.001	0.1	-	0.001	0.001	-	0.01	-	-	-
Positive pressure	500 kPa	0.5	0.001	1	-	0.01	0.01	-	0.1	-	-	-
	1 MPa	1	0.001	1	-	0.01	0.01	-	0.1	-	-	-
High pressure	2 MPa	2	0.001	1	-	0.01	0.01	-	0.2	-	-	-
	5 MPa	5	0.01	-	-	0.1	0.1	-	1	-	-	-
	10 MPa	10	0.01	-	-	0.1	0.1	-	1	-	-	-
	20 MPa	20	0.01	-	-	0.1	0.1	-	2	-	-	-
	25 MPa	25	0.02	-	-	0.2	0.2	-	2	-	-	-
Additional range	Upper limit of the set value	It varies depending on the minimum unit setting of the additional range. (All pressure units are selectable)										

<Operation>

Press the UP or DOWN button in function selection mode to display [F 0].

Press the SET button. ↓ Move on to pressure range setting.

Pressure range setting

Press the UP or DOWN button to select pressure range.

↓ [USER] is selected.
Press the SET button to move on to the setting of the minimum unit of the additional range.

Additional range minimum unit setting

Press the UP or DOWN button to select the minimum unit.

Press the SET button to set. ↓ Move on to the setting of the lower limit of the additional rated range.
The lower limit of the rated range is the displayed value when the sensor input signal is 0%.

Setting of the lower limit of the additional rated range

Press the UP or DOWN button to change the value.
Press the button continuously to keep changing the value.
Set the value that is required to be displayed when the sensor input signal is 0%.
The setting range is -1500 to 1500 digit.

Press the SET button to set. ↓ Move on to the setting of the upper limit of the additional rated range.
The upper limit of the rated range is the displayed value when the sensor input signal is 100%.

Other than [USER] is selected.
Press the SET button to move on to display unit setting.

Setting of the upper limit of the additional rated range

Press the UP or DOWN button to change the value.
Press the button continuously to keep changing the value.
Set the value that is required to be displayed when the sensor input signal is 100%.
The setting range is -1500 to 1500 digit.

Press the SET button to set. Move on to display unit setting.

Display unit setting

Press the UP or DOWN button to select the display unit.

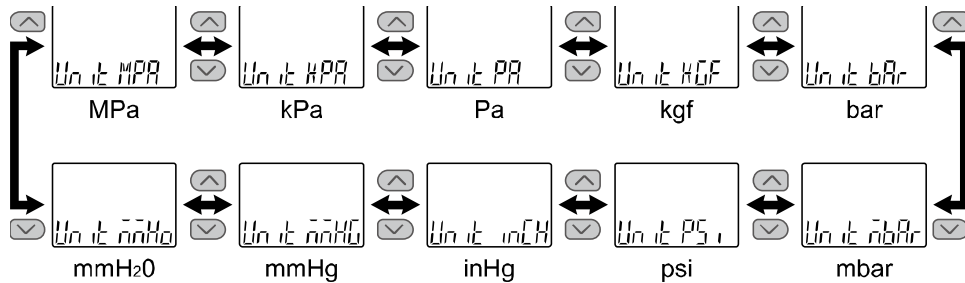

*: The unit that can be displayed is different depending on the pressure range. (Refer to page 30)
(kPa/MPa/Pa can still be selected if the product does not have the units selection function.)

Press the SET button to set. Move on to the switch output NPN/PNP specification switching setting.

Switching setting of switch output NPN/PNP specifications

The switch output of this product can be switched to NPN or PNP output in accordance with the user device construction.

Press the UP or DOWN button to select switch output specification.

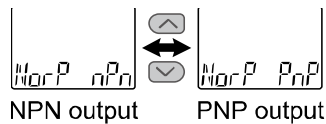

Press the SET button to set. Return to function selection mode.

[F 0] Setting of the switching function of the pressure range, display unit and switch output specifications is completed.

- Settable range of the additional range
 <Minimum settable unit [Udot]: "0.001", "0.01", "0.1", "1">

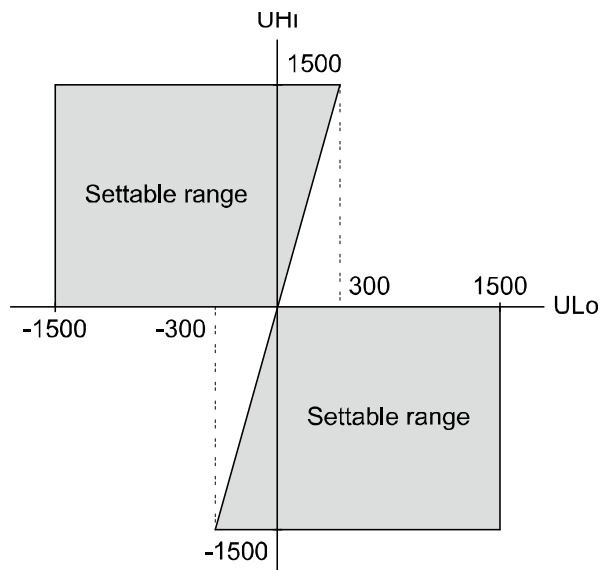

- <Minimum settable unit [Udot]: "0.002", "0.02", "0.2", "2">

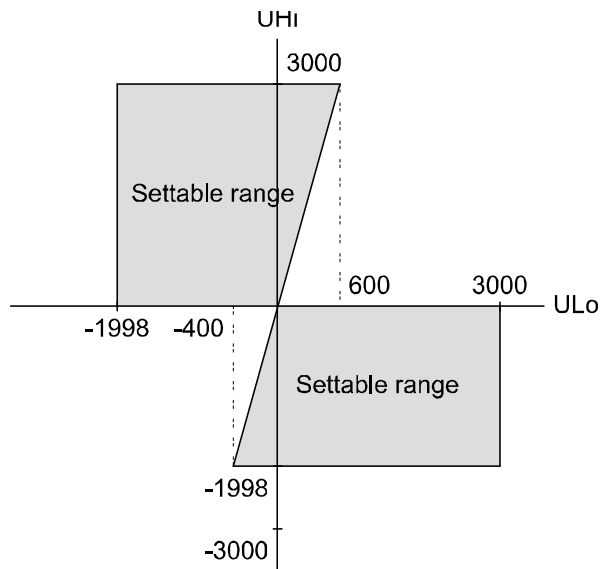

*: When pressure range, minimum unit/lower limit/upper limit of additional range is changed, setting below will be initialized and cleared. These items must be set again.

- Display unit settings
- Pressure Setting
- Hysteresis setting
- Peak/Bottom value
- Zero-clear value
- Auto-shift correction value

■[F 1] Setting of OUT1

Set the output mode of OUT1.

Output turns on when the pressure is greater than the set value. The default setting is to turn on the product when the pressure reaches the center of the atmospheric pressure and upper limit of the rated pressure range.

Output ON lights in green and output OFF lights in red as default setting.

Please refer to the "List of output modes" on page 36 for the relationship between the set items and operation.

<Operation>

Press the UP or DOWN button in function selection mode to display [F 1].

Press the SET button. ↓ Move on to output mode setting.

Output mode setting

Press the UP or DOWN button to select the required output mode.



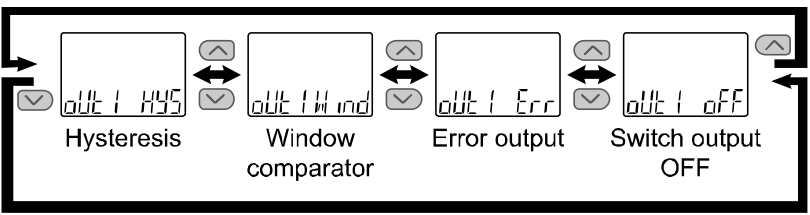

Press the SET button to set. ↓ Move on to reversed output setting.

Reversed output setting

Press the UP or DOWN button to select the reversed output.



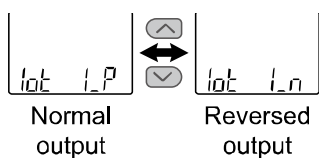

Press the SET button to set. ↓ Move on to pressure setting.

Pressure setting

Set the pressure based on the setting method on page 24.

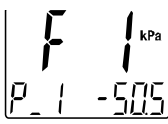

Hysteresis mode: [P_1]
 Window comparator mode: [P1L] [P1H]
 "P" is changed to "n" as [P_1] → [n_1] when reversed output is selected.
 The snap shot function can be used.
 (Refer to page 66)

Press the SET button to set. ↓ Move on to hysteresis setting.

[OFF] Switch output OFF is selected.
 Press the SET button to move on to display colour setting.

[Err] Error output is selected.
 Press the SET button to move on to display colour setting.

Hysteresis setting

Set the pressure referring to the setting method on page 24.

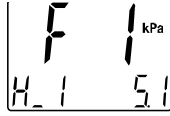

Hysteresis mode: [H_1]
Window comparator mode: [WH1]
The snap shot function can be used.
(Refer to page 66)

Press the SET button to set. Move on to delay time setting.

Delay time setting

Set the delay time referring to the setting method on page 26.

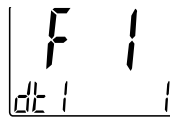

Press the SET button to set. Move on to display colour setting.

Display colour setting

Press the UP or DOWN button to select the display colour.



	Col 1500		Col 150r		Col 2500		Col 250r		Col rEd		Col Grn	
	ON: Green		ON: Red		ON: Green		ON: Red		Normally: Red		Normally: Green	
	OFF: Red		OFF: Green		OFF: Red		OFF: Green					
	(Linked to OUT1)		(Linked to OUT1)		(Linked to OUT2)		(Linked to OUT2)					

Press the SET button to set. Return to function selection mode.

[F 1] Setting of OUT1 completed

*1: Selected item becomes valid after pressing the SET button.

*2: After enabling the setting by pressing the SET button, it is possible to return to the measurement mode by keeping pressing the SET button for 2 seconds or longer.

•List of output modes

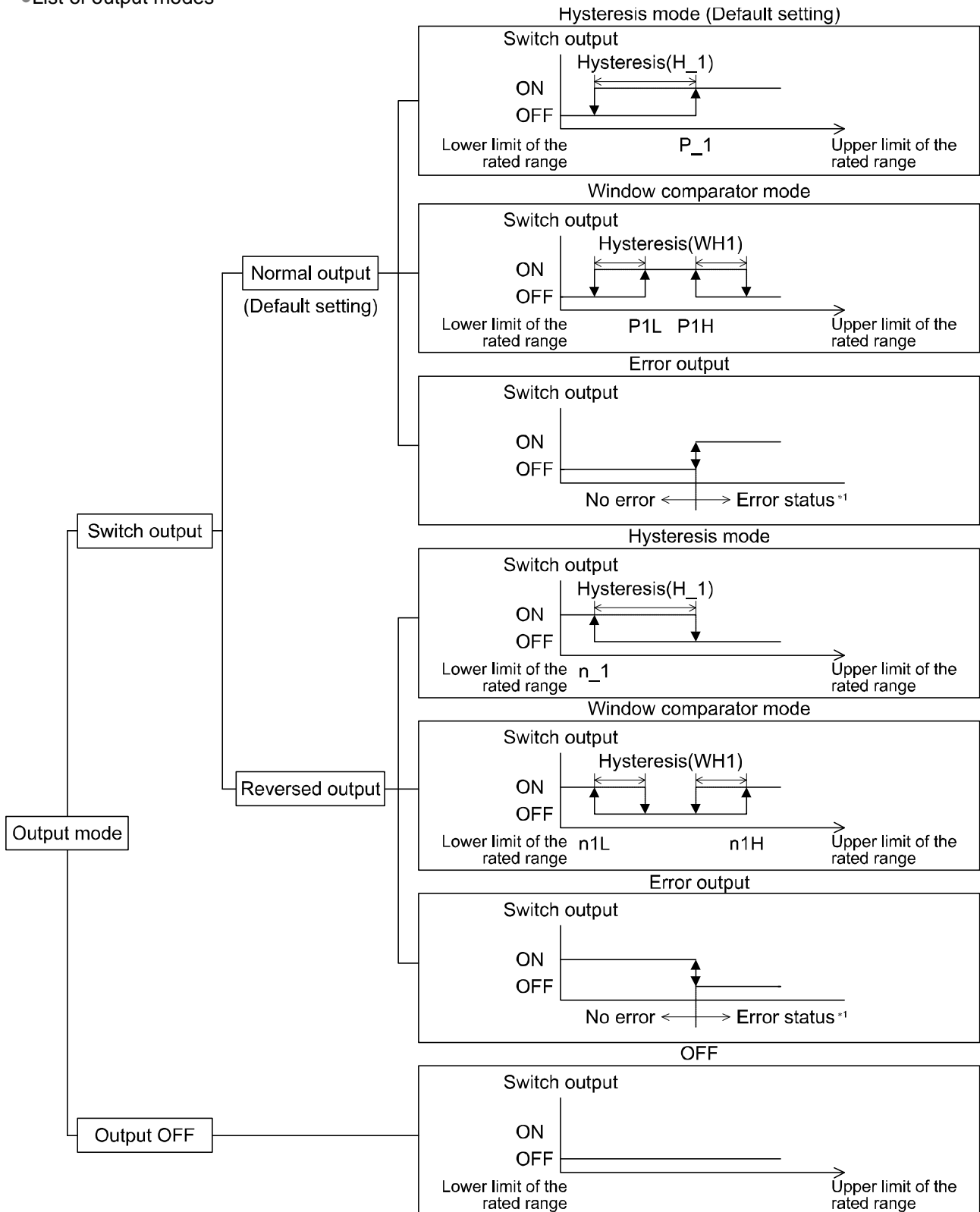

If the point at which the switch output changes is outside of the set pressure range due to the selection of normal or reversed output, the hysteresis value is automatically adjusted.

*1: The applicable errors are "Er6 to 9", "o.r." and "Er1 or 2" (excluding the error output).
(Er7 may not be output depending on the status of the data)

*: The figure above shows an operation at OUT 1. For OUT2, all "1" in the figure will be changed to "2". (e.g.) $P_1 \rightarrow P_2$

■[F 2] Setting of OUT2

Set the output mode of OUT2.

Output turns on when the pressure is greater than the set value. The default setting is to turn on the product when the pressure reaches the center of the atmospheric pressure and upper limit of the rated pressure range.

Please refer to the "List of output modes" on page 36 for the relationship between the set items and operation.

<Operation>

Press the UP or DOWN button in function selection mode to display [F 2].

Press the SET button. ↓ Move on to output mode setting.

Output mode setting

Press the UP or DOWN button to select the required output mode.

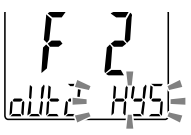

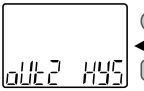

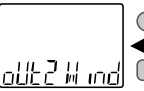

Hysteresis



Window
comparator



Error output



Switch output
OFF

Press the SET button to set. ↓ Move on to reversed output setting.

Reversed output setting

Press the UP or DOWN button to select the reversed output.

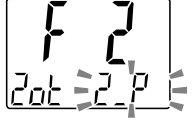

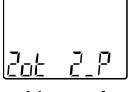

Normal
output

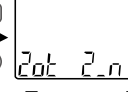

Reversed
output

Press the SET button to set. ↓ Move on to pressure setting.

Pressure setting

Set the pressure based on the setting method on page 24.

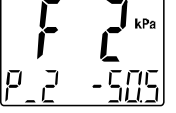

Hysteresis mode: [P_2]
 Window comparator mode: [P2L] [P2H]
 "P" is changed to "n" as [P_2] → [n_2] when reversed output is selected.
 The snap shot function can be used.
 (Refer to page 66)

[Err] Error output is selected.
Press the SET button to move on to display colour setting.

Press the SET button to set. ↓ Move on to hysteresis setting.

[OFF] Switch output OFF is selected.
Press the SET button to move on to display colour setting.

Hysteresis setting

Set the pressure referring to the setting method on page 24.

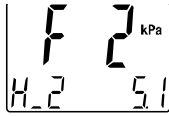

Hysteresis mode: [H_2]
Window comparator mode: [WH2]
The snap shot function can be used.
(Refer to page 66)

Press the SET button to set. Move on to delay time setting.

Delay time setting

Set the delay time referring to the setting method on page 26.



Press the SET button to set. Move on to display colour setting.

Display colour setting

Press the UP or DOWN button to select the display colour.

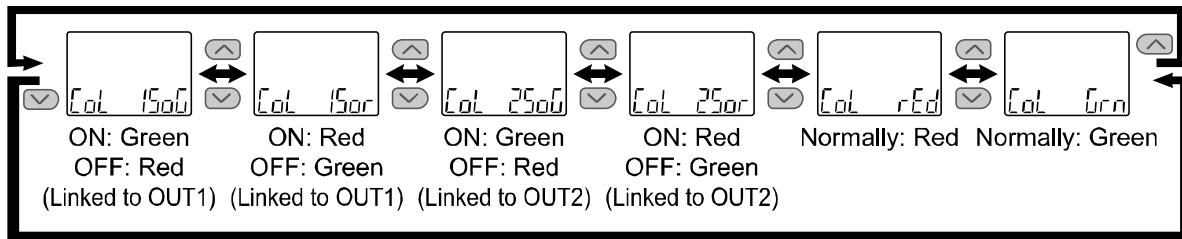

Press the SET button to set. Return to function selection mode.

[F 2] Setting of OUT2 completed

*1: Selected item becomes valid after pressing the SET button.

*2: After enabling the setting by pressing the SET button, it is possible to return to the measurement mode by keeping pressing the SET button for 2 seconds or longer.

■[F 3] Digital filter setting

The Digital filter can be selected to filter the pressure measurement.
Output chattering or flicker in the measurement mode display can be reduced by setting the digital filter.

<Operation>

Press the UP or DOWN button in function selection mode to display [F 3].

Press the SET button. ↓ Move on to digital filter setting.

Digital filter setting

Press the UP or DOWN button to select the digital filter.

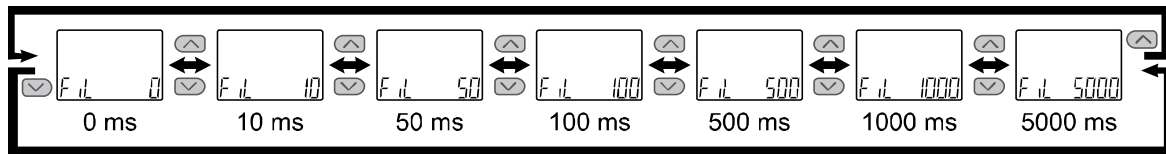

Press the SET button to set. ↓ Return to function selection mode.

[F 3] Digital filter setting completed

*1: Each set value is a guideline for 90% response time.

*2: Both the switch output and pressure display are affected. When only switch output needs to be affected, select the delay time setting. (page 26, 35 and 38)

■[F 4] Auto-preset function

This function will automatically calculate and set the optimum pressure based on the actual operating condition, when hysteresis mode has been selected.

<Operation>

Press the UP or DOWN button in function selection mode to display [F 4].

Press the SET button. ↓ Move on to Auto-preset function.

Auto-preset function

Press the UP or DOWN button to select the auto-preset function.

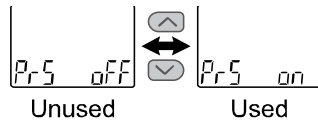

Press the SET button to set. ↓ Return to function selection mode.

[F 4] Auto-preset function completed

Press the SET button in measurement mode to perform the pressure setting.
Then, press the SET button again to change the pressure while the display is flashing.
(Refer to page 41 for details.)

●Auto-preset

When auto-preset is selected in function selection mode, the set value can be calculated and memorized from the measured pressure. Repeating the suction and release of the workpiece to be set for several times will automatically optimize the set value.

(1) Selection of auto-preset OUT1 mode

Press the SET button in measurement mode to display [AP1 REdY].
 (If setting of OUT1 is not necessary, select [AP1 REdY], and then press the UP and DOWN buttons simultaneously for 1 second or longer.
 The display will move to (4) Selection of auto-preset OUT2 mode.)



Auto-preset is ready

(2) Preparation of equipment for OUT1

Prepare the equipment for which the pressure of OUT1 is to be set.

(3) Setting of auto-preset for OUT1

Press the SET button, [AP1 RUn] will be displayed.
 Measurement starts. Operate the device to change the pressure.
 (If the UP and DOWN buttons are pressed simultaneously for 1 second or longer while [AP1 RUn] is displayed, measurement will be stopped and (4) Selection of auto-preset OUT2 mode will return.)



Auto-preset is being set

(4) Selection of auto-preset OUT2 mode

Press the SET button in measurement mode to display [AP2 REdY].
 (If setting of OUT2 is not necessary, select [AP2 REdY], and then press the UP and DOWN buttons simultaneously for 1 second or longer.
 The display will move to measurement mode.)



Auto-preset is ready

(5) Preparation of equipment for OUT2

Prepare the equipment for which the pressure of OUT2 is to be set.

(6) Setting of auto-preset for OUT2

Press the SET button, [AP2 RUn] will be displayed.
 Measurement starts. Operate the device to change the pressure.
 (If the UP and DOWN buttons are pressed simultaneously for 1 second or longer while [AP2 RUn] is displayed, measurement will be stopped and measurement mode will return.)

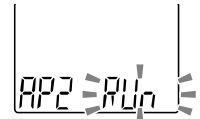

Auto-preset is being set

(7) Complete setup.

Press the SET button to complete auto-preset mode. Then, measurement mode returns.

The settings in auto-preset will be as follows.

•Normal output

$$P_1(P_2)=A-(A-B)/4$$

$$H_1(H_2)=|(A-B)/2|$$

•Reversed output

$$n_1(n_2)=B+(A-B)/4$$

$$H_1(H_2)=|(A-B)/2|$$

A = Maximum pressure

B = Minimum pressure

If setting is not necessary press the UP and DOWN buttons simultaneously for 1 second or longer.

■[F 5] FUNC terminal setting

When the product with analog output/auto shift input function is used, the FUNC terminal setting can be selected.

Analogue output: Outputs proportional output according to the applied pressure.

Auto-shift: The display indicates the change of relative flow from the reference value.

Auto-shift zero: The display is set to zero when the signal is input, and therefore the display indicates the change of relative flow from the reference value.

Copy input: Copies the set value. Refer to "[F97] Selection of copy function" on page 61.



<Operation>

Press the UP or DOWN button in function selection mode to display [F 5].

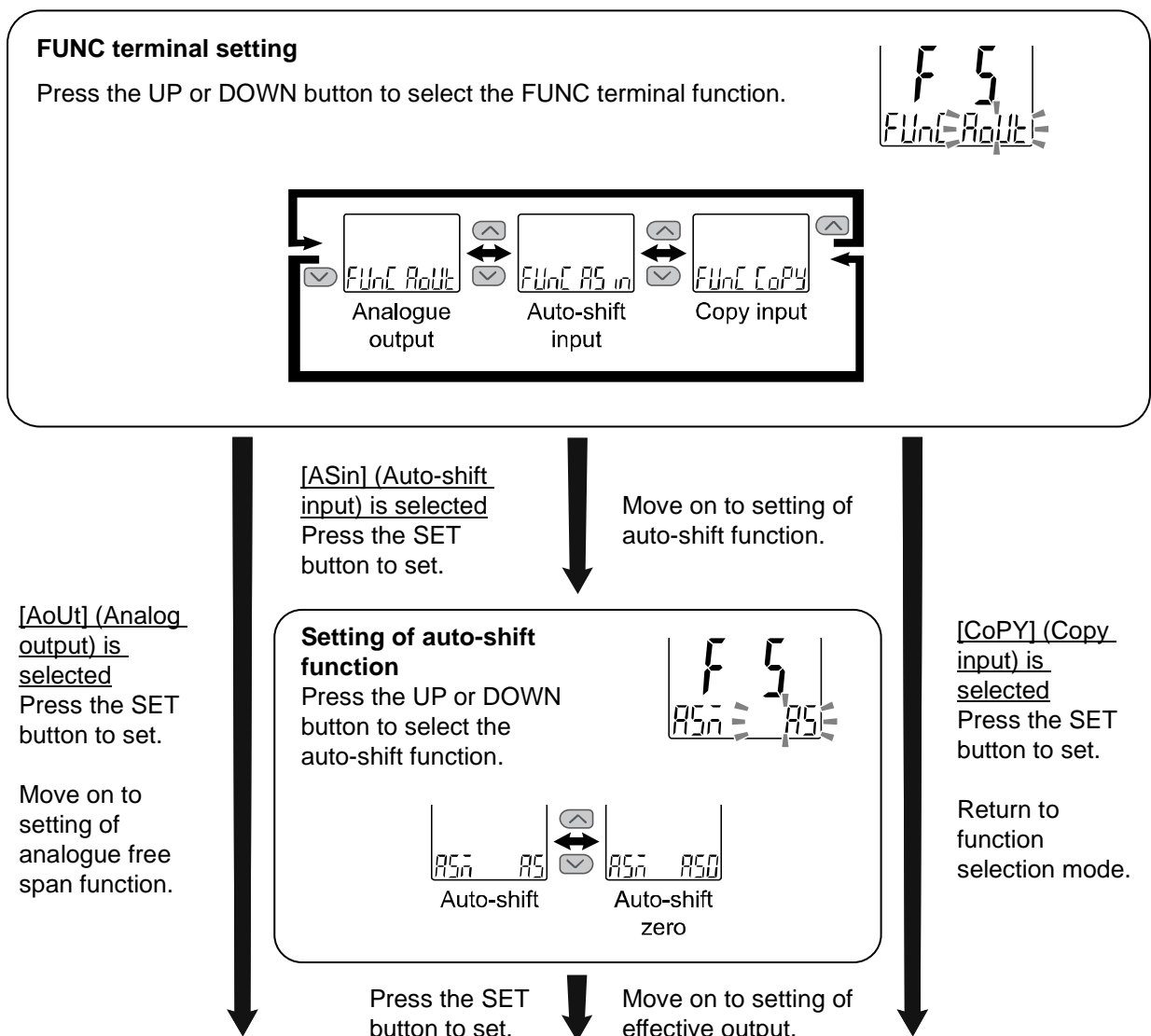
Press the SET button. ↓ Move on to FUNC terminal setting.



Setting of analogue free span function

Press the  or  button to select the analogue free span function.

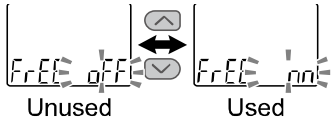

[oFF] not used
Press the SET button to set.

Return to function selection mode.

[on] is enabled
Press the SET button to set.

Move on to set value.

Set value

Press the UP or DOWN button to set the analogue span point (5 V, 20 mA) within the range of 10 to 105%* of the rated pressure range.

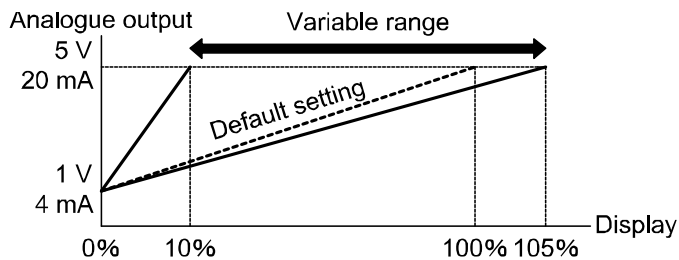

*: Up to the upper limit of the display/set pressure range.

Press the SET button to set.

Return to function selection mode.

Setting of effective output

Press the UP or DOWN button to select the effective output.

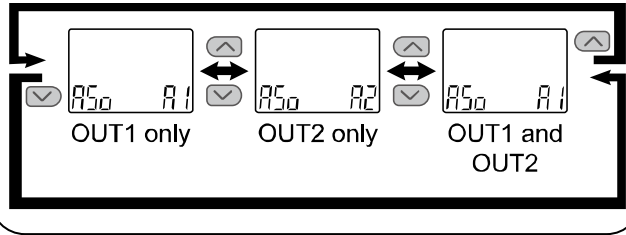

Press the SET button to set.

Return to function selection mode.

[F 5] FUNC terminal setting completed

Conditions and explanations for auto-shift function

- Maintain a constant pressure for 5 ms or longer from the end of the auto-shift input signal.
- The sub screen displays "ASin 000" for approximately 1 second during auto-shift input, and the pressure value is stored as the corrective value "C_5".
- With the corrected value stored, the set value is compensated.
- When the set value is corrected, the switch output will operate in accordance with the delay time, within 5 ms after the auto-shift input.
- If the measurement pressure during the auto-shift input operation exceeds the set pressure range, the corrected value will not be stored, but "ASin o.r" will be displayed on the sub screen for approximately 1 second.
- If the measurement value during auto-shift input is within the set pressure range, and the set value corrected by auto-shift (including hysteresis) exceeds the set pressure range, the set value will be corrected to the upper or lower value (whichever is closer).
(The correction is performed when the auto-shift input is applied at the pressure beyond the set pressure range. If the auto-shift input is applied again at the pressure within the set pressure range, the correction is released and the product operates according to the set value).
- The corrected value memorized on "C_5" can be displayed on the sub screen in measurement mode.
(Refer to "Sub display" on page 48.)
- The corrected value [C_5] after auto-shift input will disappear when the power is turned off, and will reset to zero (initial value) when the power is returned.

Using the auto-shift input, the acceptable set range is as follows:

Range setting	Acceptable set range
0 to 2 kPa	-2.30 to 2.300 kPa
0 to -101 kPa	115.0 to -115.0 kPa
-100 to 100 kPa	-210 to 210.0 kPa
0 to 100 kPa	-115.0 to 115.0 kPa
0 to 500 kPa	-575 to 575 kPa
0 to 1 MPa	-1.155 to 1.155 MPa
0 to 2 MPa	-2.20 to 2.205 MPa
0 to 5 MPa	-5.50 to 5.35 MPa
0 to 10 MPa	-11.00 to 11.00 MPa
0 to 20 MPa	-22.0 to 22.00 MPa
0 to 25 MPa	-27.5 to 27.52 MPa

■[F 6] Fine adjustment of display value

This function is to manually perform a fine adjustment of the displayed pressure value.
Pressure can be adjusted in the following range of $\pm 5\%$ R.D.

<Operation>

Press the UP or DOWN button in function selection mode to display [F 6].

Press the SET button. ↓ Move on to fine adjustment of display value.

Fine adjustment of display value

Press the UP or DOWN button to change adjustment rate.

When adjustment rate is changed, the pressure value after the adjustment will be displayed on the main screen.

Pressure after adjustment



Adjustment rate

Press the SET button to set. ↓ Return to function selection mode.

[F 6] Fine adjustment of display value completed

■[F10] Sub display setting

Change the display style of the sub display.
Detailed set contents are shown in the pages from 48.

<Operation>

Press the UP or DOWN button in function selection mode to display [F10].

Press the SET button. ↓ Move on to sub display setting.

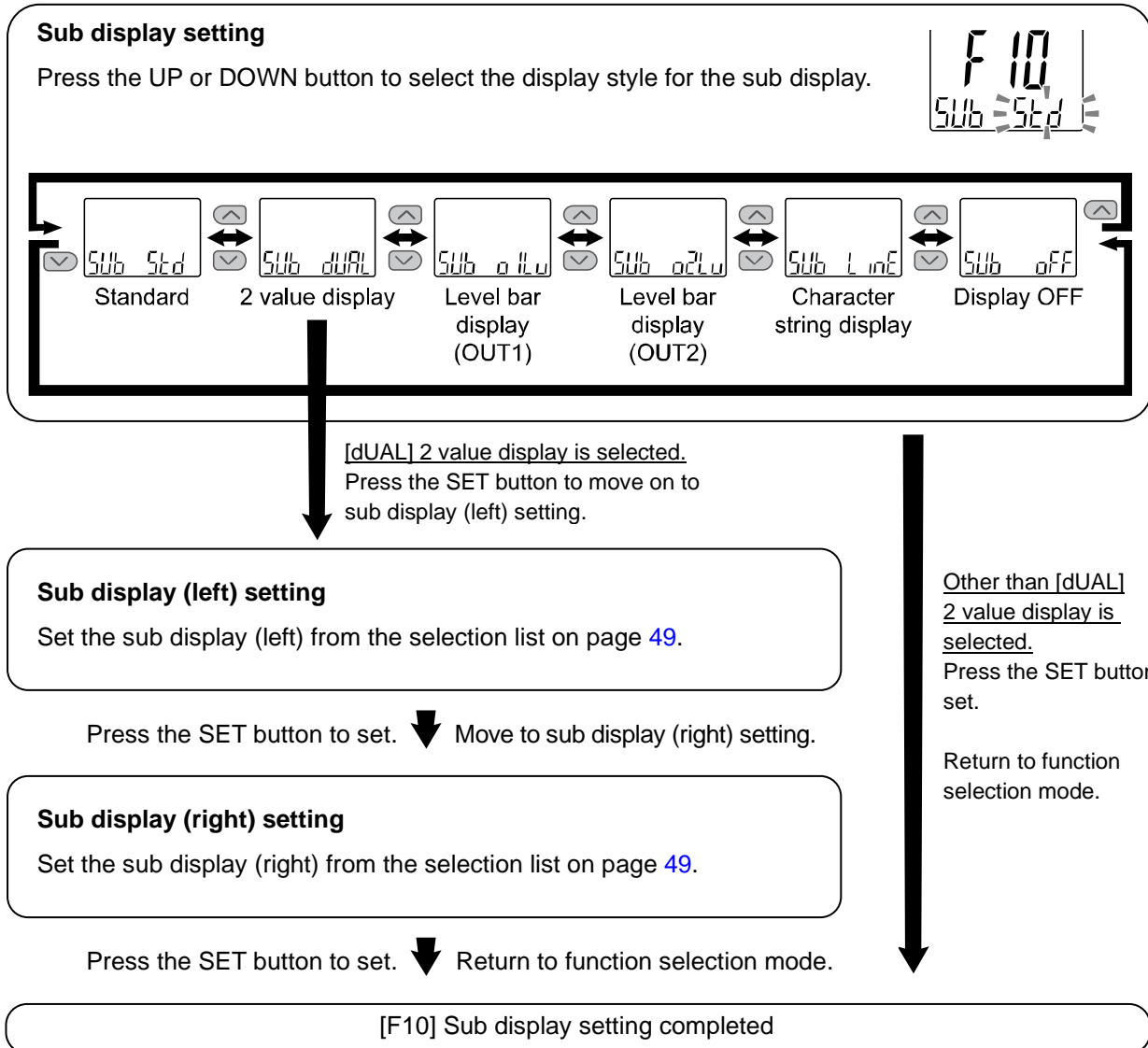

<Sub display>

•Standard

The Standard display function displays the items and values on the sub display.

The displayed item varies depending on the setting of the output mode. Select the displayed items by pressing the UP or DOWN button in measurement mode.

(Hysteresis mode, error output, switch output off)

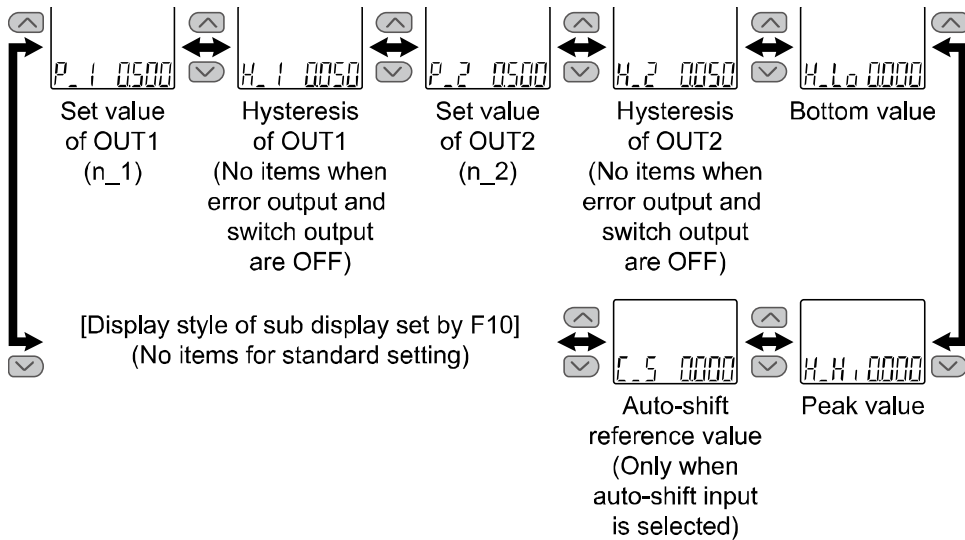

(Window comparator mode)

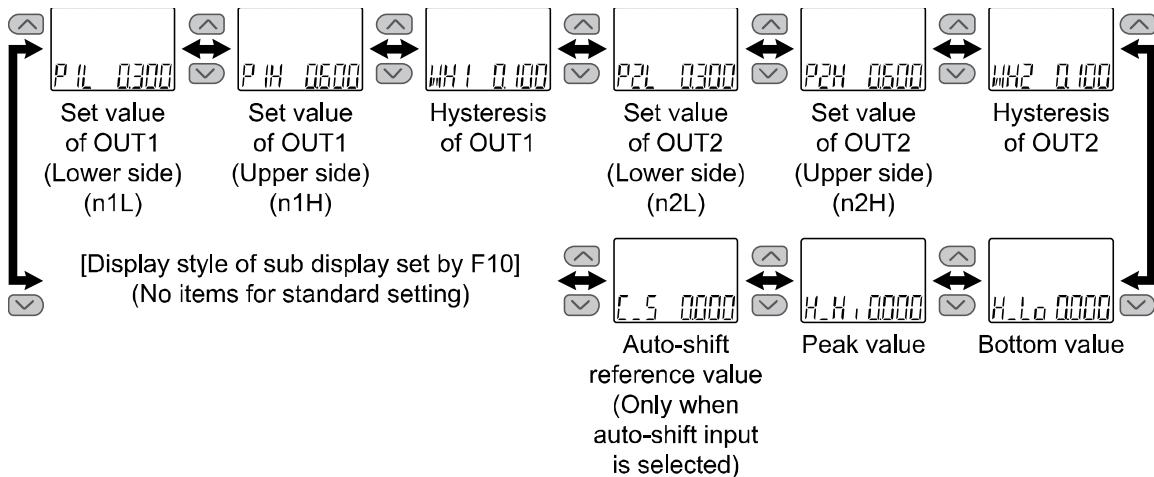

•2 value display

The 2 value display function displays the items listed below on the right and left side of the sub display.

List of items for selection

Item	Details	Sub display		Remarks
		Left side	Right side	
P ₁ (n ₁)	Set value for OUT1 hysteresis mode	○	○	When hysteresis mode is selected
H ₁	OUT1 hysteresis mode	○	○	When hysteresis mode is selected
P _{1L} (n _{1L})	OUT1 Window comparator mode set value (Lower side)	○	○	When window comparator mode is selected
P _{1H} (n _{1H})	OUT1 Window comparator mode set value (Upper side)	○	○	When window comparator mode is selected
WH ₁	OUT1 window comparator mode	○	○	When window comparator mode is selected
P ₂ (n ₂)	Set value for OUT2 hysteresis mode	○	○	When hysteresis mode is selected
H ₂	OUT2 hysteresis mode	○	○	When hysteresis mode is selected
P _{2L} (n _{2L})	OUT2 Window comparator mode set value (Lower side)	○	○	When window comparator mode is selected
P _{2H} (n _{2H})	OUT2 Window comparator mode set value (Upper side)	○	○	When window comparator mode is selected
WH ₂	OUT2 window comparator mode	○	○	When window comparator mode is selected
H _H	Pressure peak value	○	×	
H _L	Pressure bottom value	×	○	
Unit	Pressure display unit	○	○	
RR	Rated pressure range	○	○	
Md ₁	OUT1 output mode/output style	○	×	
Md ₂	OUT2 output mode/output style	×	○	
OUT	NPN/PNP output set value	○	○	
LinE	String of random characters	○	○	
off	Display OFF	○	○	

Table showing the output mode and output form when Md1 and Md2 are selected.

Output mode	Output style	Display style
Hysteresis mode	Normal output	
	Reversed output	
Window comparator mode	Normal output	
	Reversed output	
Error output	Normal/Reversed output	
Switch output off	-	

When using the 2 value display function, 3 step setting is not available for the display.
 (When setting 3 step, select each set value to be displayed by pressing the UP or DOWN button.)

When output operation mode is changed after selecting the 2 value display, the selected display items will not be applicable and [- -] will be displayed. In this case, select items for the 2 value display setting again.

•Level bar display

The Level bar display is a function used to visualize the pressure and the ON area for the switch output on the sub display.

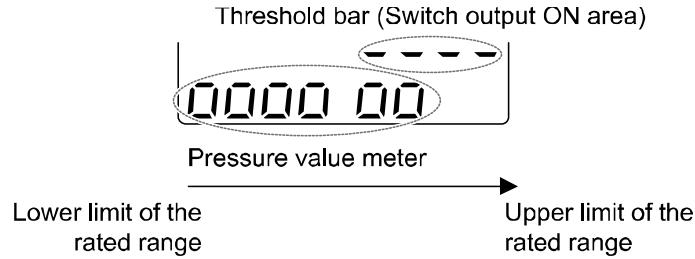

The display style varies depending on the setting of the output mode.

(In hysteresis mode or window comparator mode)

The threshold bar displaying the switch output ON area is displayed according to the table below, using the output mode.

(During error output or when the switch output is OFF)





The threshold bar will not be displayed. Only the pressure value meter is displayed.

Output mode	Output style	Threshold bar display style
Hysteresis mode	Normal output	P ₁
	Reversed output	n ₁
Window comparator mode	Normal output	P1L P1H
	Reversed output	n1L n1H
Error output	Normal/Reversed output	No indication
Switch output off	-	No indication

The Level bar display resolution (pressure for one "O") varies depending on the output mode.

Output mode	Display resolution	
	OUT1	OUT2
Hysteresis mode	1/10 of P ₁ (n ₁)	1/10 of P ₂ (n ₂)
Window comparator mode	1/4 of P1H – P1L (n1H – n1L)	1/4 of P2H – P2L (n2H – n2L)
Error output	1/7 of rated maximum pressure - rated minimum pressure	
Switch output off		

During an error output or when the switch output setting is OFF, the pressure value meter at the atmospheric pressure is displayed according to the table below.

Rated range	Display at atmospheric pressure	
Other than compound pressure		or 
Compound pressure		or 

•Character string display

The Character string display function will display the specified characters on the sub display (right). Character setting is performed using the function [F82] Input of line name.

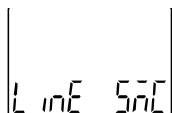

•Display OFF

The Sub display is not displayed.

■[F11] Display resolution setting

This function is to change the pressure display resolution.
The flicker of the display can be reduced.

<Operation>

Press the UP or DOWN button in function selection mode to display [F11].

Press the SET button. ↓ Move on to display resolution setting.

Display resolution setting

Press the UP or DOWN button to select the display resolution.

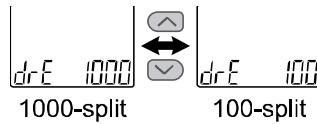

Press the SET button to set. ↓ Return to function selection mode.

[F11] Display resolution setting completed

- *: The display resolution is not possible to be selected while setting the additional range.
- *: It may not be possible to change the resolution depending on the unit of pressure selected.

The units that allow display resolution to be selected are [MPa], [kPa], [kgf/cm²], [bar], [mbar], [psi], [inHg] and [mmH₂O].

(The units [kgf/cm²], [bar], [mbar], [psi], [inHg] and [mmH₂O] can only be set when using a product with units selection function.)

➡ Page 30 [F 0] Units selection function

■[F80] Power saving mode

Power saving mode can be selected.

When selected and no buttons are pressed for 30 seconds, the product will shift to power saving mode.

<Operation>

Press the UP or DOWN button in function selection mode to display [F80].

Press the SET button. ↓ Move on to power saving mode.

Power saving mode

Press the UP or DOWN button to select the power saving mode.

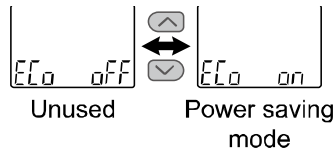

Press the SET button to set. ↓ Return to function selection mode.

[F80] Power saving mode completed

In power saving mode, when buttons are pressed the display is normal, but if no buttons are pressed for 30 seconds, it will revert to power saving mode. (Power saving is only enabled in measurement mode)

During power saving mode, [ECo] will flash in the sub display and the operation light is ON (only when the switch is ON).

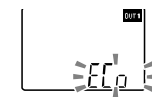

At switch ON

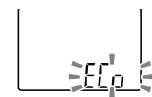

At switch OFF

■[F81] Security code

The security code can be turned on or off and the security code can be changed when unlocked.

<Operation>

Press the UP or DOWN button in function selection mode to display [F81].

Press the SET button. ↓ Move on to security code.

Security code

Press the UP or DOWN button to select the setting of security code.

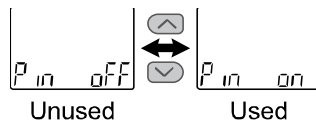

Press the SET button to set. ↓ Move on to security code checking.

Security code checking

Press the UP or DOWN button to input the security code on the sub display (right).

(The default setting is [000].) *

For instructions on how to enter the security code, refer to "How to input and change the security code" on page 69.

If the security code entered is incorrect, [FAL] will be displayed, and the security code must be entered again.

If the wrong security code is entered 3 times, [nG] is displayed and the device returns to function selection mode.



[oFF] (not use) is selected.

Press the SET button to return to function selection mode.

Press the SET button for 1 second to set. ↓ Move on to security code changing.

Security code changing

Press the UP or DOWN button to input the changed security code on the main display. *
For instructions on how to enter the security code, refer to "How to input and change the security code" on page 69.



After entry, the changed security code will flash by pressing the SET button for 1 second.
(At this point, the changing of the security code is not completed)
Return to the change of setting again by pressing the UP or DOWN button.



Press the SET button for 1 second to set. Return to function selection mode.

[F81] Security code completed

If the security code function is enabled, it is will be necessary to input a security code to release the key-lock.

*: If a key is not pressed for 30 seconds while entering the security code, function selection mode will return.

■[F82] Input of line name

Function to display the specified character string on the sub display.

To display in the measurement mode, select 2 value display [dUAL] or character string display [LinE] using the setting on [F10] Sub display setting.

<Operation>

Press the UP or DOWN button in function selection mode to display [F82].

Press the SET button. ↓ Move on to input of line name.

Input of line name

Press the UP or DOWN button to input the line name displayed on the sub display (right).

Press the SET button to make the next digit to the right flash. Input the line name.

(The most significant digit flashes when the SET button is pressed at the least significant digit.)

The order of displayed characters is A → b → ••• → Y → (Z) → 0 → 1 → ••• → 9 → symbol → space.

(Characters which can be displayed are different for 1 digit on the left and 3 digits on the right.)

Pressing the UP and DOWN button simultaneously adds/deletes the dot (decimal point).

The set line name flashes by pressing the SET button for 1 second or longer.

(At this point, the setting of the line name is not complete.)



Press the SET button to set. ↓ Return to function selection mode.

[F82] Input of line name completed

•Characters which can be displayed for each digit are as follows.

(Pattern for 3 digits on the right)

Characters Q, X, Z, /, or * cannot be displayed.

A	B	C	D	E	F	G	H	I	J	K	L	M	N	O	P	R	S	T	U	V	W	Y
a	b	c	d	e	f	g	h	i	j	k	l	m	n	o	p	r	s	t	u	v	w	y

0	1	2	3	4	5	6	7	8	9	Symbol	Space (Dot)
---	---	---	---	---	---	---	---	---	---	--------	-------------

0	1	2	3	4	5	6	7	8	9	_	-	.
---	---	---	---	---	---	---	---	---	---	---	---	---

(Pattern for 1 digit on the left)

Characters A to Z can be displayed (the same as the 3 digits on the right).

A	B	C	D	E	F	G	H	I	J	K	L	M	N	O	P	Q	R	S	T	U	V	W	X	Y	Z
a	b	c	d	e	f	g	h	i	j	k	l	m	n	o	p	q	r	s	t	u	v	w	x	y	z

<Pattern for 3 digits on the right>

0	1	2	3	4	5	6	7	8	9	Symbol	K	M	N	R	V	W	Space (Dot)
---	---	---	---	---	---	---	---	---	---	--------	---	---	---	---	---	---	-------------

0	1	2	3	4	5	6	7	8	9	_	-	/	#	^	~	u	.
---	---	---	---	---	---	---	---	---	---	---	---	---	---	---	---	---	---

● **Special function setting**

■ **[F90] Setting of all functions**

All functions can be set in turn.

<Operation>

Press the UP or DOWN button in function selection mode to display [F90].

Press the SET button. ↓ Move on to setting of all functions.

Setting of all functions

Press the UP or DOWN button to select all functions.



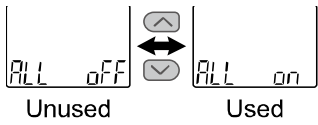

[oFF] (not use) is selected.
Press the SET button to set.

Return to function selection mode.

↓ [on](use) is selected.

Setting of functions *

Return to [oFF] (not used),
then press the SET button to set.

Return to function selection mode.

[F90] Setting of all functions completed

*: Setting of each function

Every time the SET button is pressed, the display moves to the next function in order of "Setting of each function" on page 59. Set by using the UP and DOWN buttons.

For details of how to set each function, refer to the relevant setting of function section in this manual.

*: Measurement mode can be returned from any setting items by pressing and holding the SET button for 2 seconds or longer.

*: The function setting from before returning to the measurement mode is maintained.

● Setting of each function

Order	Function
1	Pressure range setting
2	Display unit selection
3	Switching setting of switch output NPN/PNP specifications
4	Output mode setting of OUT1
5	Reversed output setting of OUT1
6	Pressure setting of OUT1
7	Hysteresis setting of OUT1
8	Delay time setting of OUT1
9	Display colour setting
10	Output mode setting of OUT2
11	Reversed output setting of OUT2
12	Pressure setting of OUT2
13	Hysteresis setting of OUT2
14	Delay time setting of OUT2
15	Display colour setting
16	Digital filter setting
17	Auto-preset function
18	FUNC terminal setting *
19	Fine adjustment of display value
20	Sub display setting
21	Display resolution setting
22	Power saving mode
23	Security code
24	Input of line name

*: Measurement mode can return from any setting item by pressing the SET button for 2 seconds or longer.

*: Function set before returning to the measurement mode is maintained.

*: Moves to analogue free span function setting and auto shift function setting by setting the FUNC terminal.

■[F96] Input signal check

The sensor input signal (1 to 5 V or 4 to 20 mA) and the external input signal can be checked.

<Operation>

Press the UP or DOWN button in function selection mode to display [F96].

Press the SET button. ↓ Move on to input signal check.

Input signal check

Select to display the sensor input or external input signal condition by pressing the SET button.

*: Only the sensor input can be displayed if the external input signal [F 5] is not set.

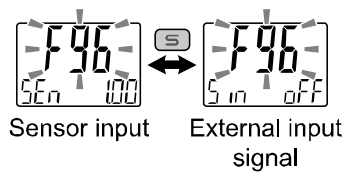

■[F97] Selection of copy function

The set values can be copied. The set values of pressure and functions can be copied. When the input, output and unit specifications are the same, this function becomes available. The set value can be copied to up to 10 pressure switches simultaneously.

<Connection>

Connect the pressure switches with the power supply turned off.

Connect the FUNC terminals of the copy source sensor monitor and the copy destination sensor monitor, and then turn on the power supply.

The copy source sensor monitor is the sensor monitor from which the setting is to be copied.

The copy destination sensor monitor is the switch to which the setting is to be copied.

When the output specification of the copy destination display setting device is not "6", the output specification should be set to copy input in accordance with the [F 5]FUNC terminal setting (page 42) beforehand.

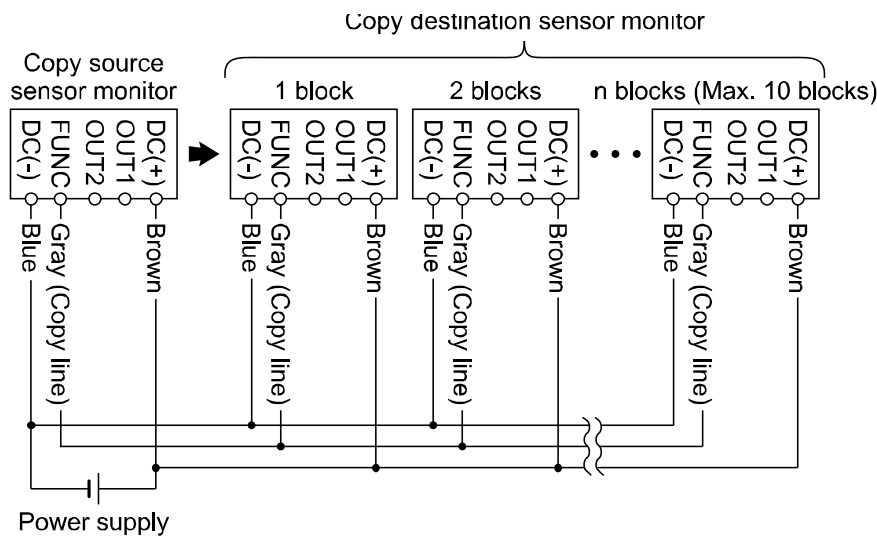

<Operation>

Press the UP or DOWN button of the copy source sensor monitor in function selection mode to display [F97].

Press the SET button. ↓ Move on to selection of copy function.

Selection of copy function

Press the UP or DOWN button to select copy function.

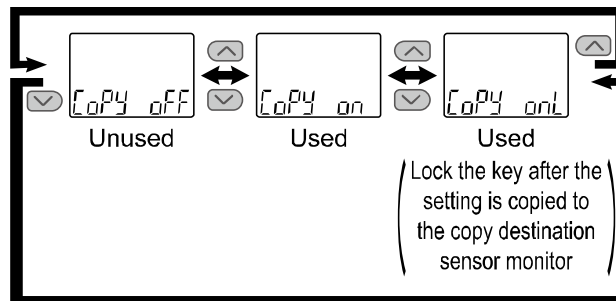

[oFF] (not use) is selected
Press the SET button to set.

Return to function selection mode.

[on] (use)
[onL] (use) is selected
Press the SET button to set.

Move to copy ready status.

Copy ready status



Copy is ready

Even though the power supply is turned OFF, the copy ready status will be retained.

Press the SET button to start copying.

	The copy source sensor monitor	The copy destination sensor monitor
Sending/ Receiving	<p>Main display: Red</p>	<p>Main display: Green</p>
Copy completed	<p>Main display: Red</p>	<ul style="list-style-type: none"> •When completed normally <p>Main display: Green</p> •When error occurs <p>Main display: Red</p>

(Copy source)
Press the SET
button.

The copy can be made continuously and the copy ready status can be held even if the power supply is turned off.



Copy is ready

(Copy source)
Press the UP and
DOWN buttons
simultaneously for
1 second or longer.

(Copy destination)
When
completed
normally.
Press the SET

To complete the copy function,
press the UP and DOWN buttons
simultaneously for 1 second or
longer.

[F97] Setting of selection of copy function completed

Measurement mode

- *: When the copy destination sensor monitor displays [Er13], it indicates a sending and receiving error of the copy function. Press the UP and DOWN buttons simultaneously for 1 second or longer to return to measurement mode. Then, check the wiring and specifications of the switch and retry the copy function.
- *: When copy is conducted so that the analog output is used, set the FUNC terminal setting of the copy source sensor monitor to Aout, then conduct a copy. The FUNC terminal setting of the copy destination sensor monitor will be Aout when the copy is complete.
- *: Copying may not be executed depending on the timing. In that case try again.

■[F98] Output check

The switch output or analogue output can be selected for an output check.
The output can be turned ON/OFF manually for checking.

<Operation>

Press the UP or DOWN button in function selection mode to display [F98].

Press the SET button. ↓ Move on to output check.

Output check

Press the UP or DOWN button to select output check.

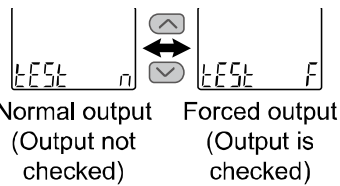

When [F] (Forced output) is selected.
Press the SET button to set.

When [n] (Normal output) is selected.
Press the SET button to set.

Return to function selection mode.

OUT1 output check

Press the UP or DOWN button to select OUT1 output check.

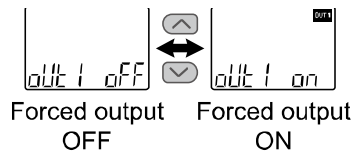

Press the SET button to set.

OUT2 output check

Press the UP or DOWN button to select OUT2 output check.

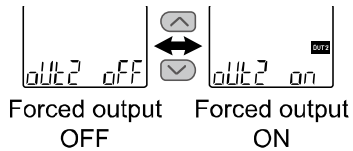

When switching of analogue output is selected for the setting of [F 5] FUNC terminal function Press the SET button to move on to FUNC terminal function setting.

FUNC terminal function setting

Press the UP or DOWN button to select the analogue output.

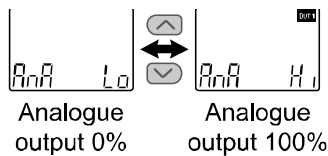

When external input or copy function is selected for the setting of [F 5] FUNC terminal function.

Press the SET button to set.

Return to function selection mode.

Press the SET button to return to [n] (normal output), then press the SET button to set.

Return to function selection mode.

[F98] Output check completed

*: Measurement mode can be returned from any setting by pressing the SET button for 2 seconds or longer.

■[F99] Reset to default settings

If the product settings are uncertain, the default values can be restored.

<Operation>

Press the UP or DOWN button in function selection mode to display [F99].

Press the SET button. ↓ Move on to reset to default settings.

Reset to default settings

Press the UP or DOWN button to display [ON], then press the SET and DOWN buttons simultaneously for 5 second or longer.

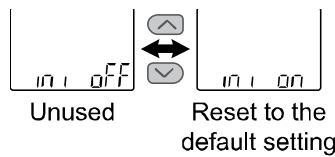

[oFF] (not use) is selected.
Press the SET button to set.

Return to function selection mode.



All settings are returned to the default values. Return to function selection mode.



[F99] Reset to default settings completed

Other Settings

○ Snap shot function

The current pressure value can be stored to the switch output ON/OFF set point.

When the items of sub display (left) below are selected in 3 step setting mode, simple setting mode or function selection mode ([F 1] Setting of OUT1, [F 2] Setting of OUT2), by pressing the UP and DOWN buttons simultaneously for 1 second or longer, the value of the sub display (right) shows [- - -], and the values corresponding to the current pressure values are automatically displayed.

Output mode	Configurable items	Sub display (left)	Snap shot function
Hysteresis mode	Set value	$P_{-1} (n_{-1}) / P_{-2} (n_{-2})$	○
	Hysteresis	H_{-1} / H_{-2}	○
Window comparator mode	Set value	$P_{1L} (n_{1L}), P_{1H} (n_{1H})$ $P_{2L} (n_{2L}), P_{2H} (n_{2H})$	○
	Hysteresis	H_{11} / H_{12}	×

• Set value

The value is set to the same value as the display value (current pressure value).

(There is a range which cannot be set to the current pressure depending on the hysteresis. In that case, the value is set to the closest value.)

• Hysteresis

The hysteresis is calculated from the equation below and set.

Normal output: (set value) - (current pressure value) Reverse output: (current pressure value) - (set value)

If the calculation result becomes 0 or less, [Err] is displayed on the sub display (right) and the set value is not changed.

Afterwards, it is possible to adjust the value by pressing the UP or DOWN button.

○ Peak/bottom value indication

The maximum (minimum) pressure when the power is supplied is detected and updated.

In peak/bottom indication mode, the current pressure is displayed.

Press the UP or DOWN button in measurement mode to switch the sub-display (left) to the display shown below. Peak/bottom values are displayed on the sub display (right) at the same time as the current pressure value on the main display.

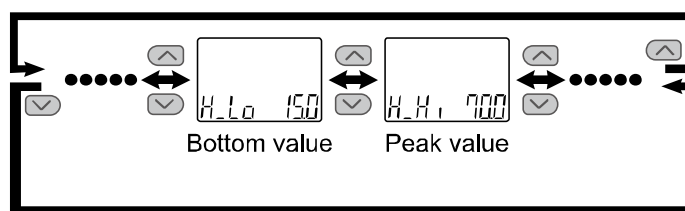

Peak/bottom values are maintained even if the power supply is cut.

When the SET and DOWN buttons are pressed for 1 second or longer simultaneously while the peak/bottom values are displayed, the sub display (right) displays [- - -] and the maximum (minimum) pressure value are cleared.

○ Zero-clear function

The displayed value can be adjusted to zero if the pressure being measured is within $\pm 7\%$ F.S ($\pm 3.5\%$ F.S. for compound pressure) of the zero point set at the time of default settings.

(The zero clear range varies by $\pm 1\%$ F.S. due to variation between individual products.)

In measurement mode, when the UP and DOWN buttons are pressed for 1 second or longer simultaneously, the main display shows [- - -], and the reset to zero. The display returns to measurement mode automatically.

○Key-lock function

The key-lock function is used to prevent errors occurring due to unintentional changes of the set values. If the SET button is pressed while the keys are locked, [LoC] is displayed on the sub display (left) for approximately 1 second.

(Each setting and peak/bottom values are displayed with UP and DOWN buttons.)

<Operation - Without security code input ->

- (1) Press the SET button for 5 seconds or longer in measurement mode. When [oPE] is displayed on the main display, release the button.

The current setting [LoC] or [UnL] will be displayed on the sub display.

(To release key-lock repeat the above operation.)



- (2) Select the key-locking/un-locking with UP or DOWN button, and press the SET button to set.

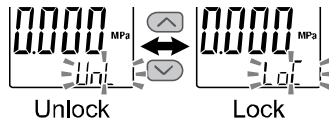

<Operation – With security code input ->

•Locking

- (1) Press the SET button for 5 seconds or longer in measurement mode. When [oPE] is displayed on the main display, release the button.

The current setting [LoC] or [UnL] will be displayed on the sub display.



- (2) Select the key [LoC] with UP or DOWN button, and press the SET button to set.

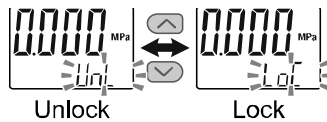

•Unlocking

- (1) Press the SET button for 5 seconds or longer in measurement mode. When [oPE] is displayed on the main display, release the button.

The current setting [LoC] or [UnL] will be displayed on the sub display.



- (2) Select the un-locking [UnL] with  or  button. Setting is recognized by pressing the SET button, then security code is required.

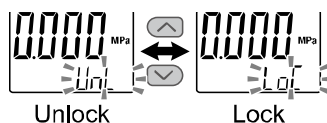

- (3) For instructions on how to enter the security code, refer to "How to input and change the security code" on page 69.

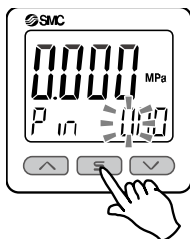

- (4) If inputted security code is correct, the indication of the main display changes to [UnL], and pressing the one of UP, SET or DOWN button releases key-lock and the measurement mode returns.
If the security code entered is incorrect, [FAL] will be displayed, and the security code must be entered again. If the wrong security code is entered 3 times, [LoC] is displayed and the device returns to measurement mode.

●How to input and change the security code

The left most digit starts flashing.

Press the UP or DOWN button to select a value.

Press the SET button to make the next digit to the right flash.

(If the SET button is pressed at the last digit, the first digit will start flashing.)

After the setting is complete, press and hold the SET button for 1 second or longer.

(If an operation is not performed for 30 seconds during input or change of the security code, it will return to measurement mode.)

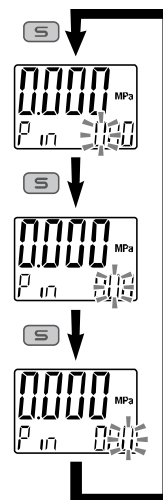

Maintenance

How to reset the product after a power cut or forcible de-energizing

The setting of the product will be retained as it was before a power cut or de-energizing. The output condition is also basically recovered to that before a power cut or de-energizing, but may change depending on the operating environment. Therefore, check the safety of the whole installation before operating the product. If the installation is using accurate control, wait until the product has warmed up (approximately 10 to 15 minutes).

Forgotten the security code

If you have forgotten your security code, please contact SMC directly.

Troubleshooting

○Troubleshooting

When any failure occurs with this product, the following chart can be used to identify the cause of the failure. If a cause applicable to the troubles cannot be identified and normal operation is recovered by replacement with a new product, this indicates that the product itself was faulty. Problems with the product may be due to the operating environment (installation etc). Please consult SMC.

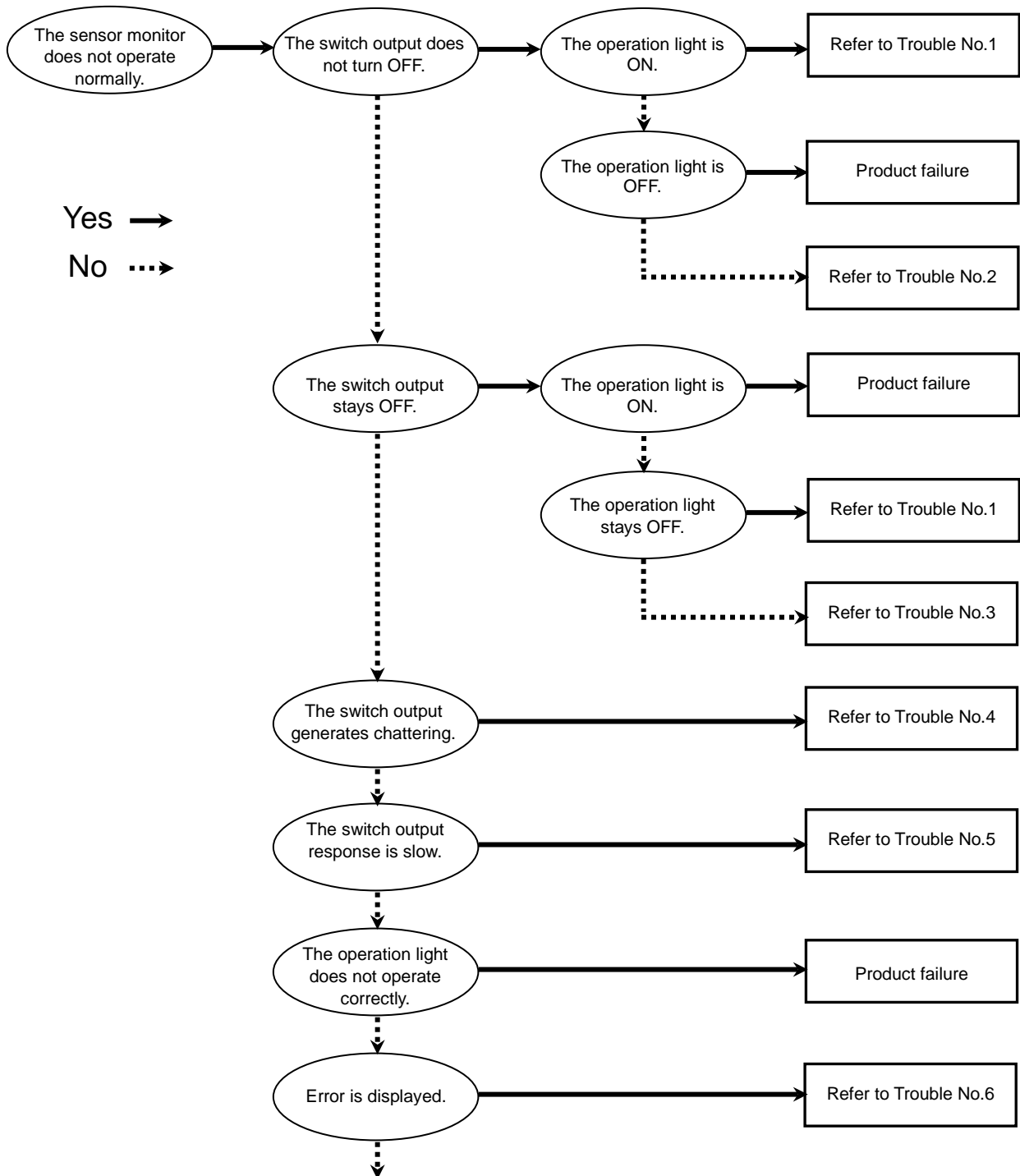

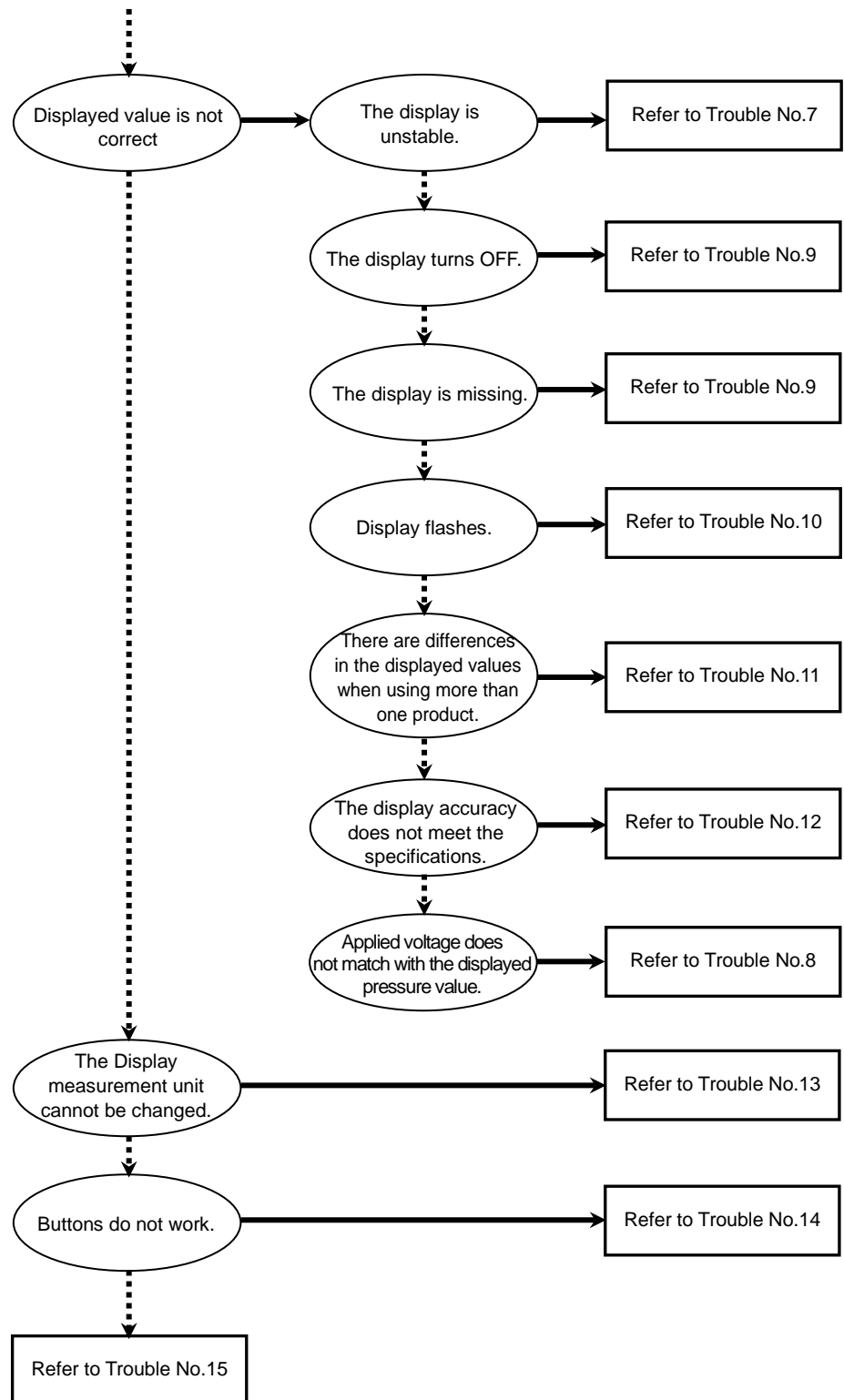

○Troubleshooting list

Problem No.	Problem	Problem possible causes	Investigation method	Countermeasures
1	<ul style="list-style-type: none"> •The switch output does not turn OFF. The operation light stays ON. •The switch output does not turn ON. The operation light stays OFF. 	Incorrect pressure setting	(1) Check the set pressure value. (2) Check the settings of the operation mode, hysteresis and output type. (In hysteresis mode or window comparator mode, and normal output/ reversed output)	(1) Adjust the set pressure value. (2) Set the operation mode, hysteresis and output type again.
		Product failure		Replace the product.
2	The switch output does not turn OFF. The operation light is normal.	Incorrect wiring	Check the output wiring. Check if the load is directly connected to DC(+) or DC(-).	Check and correct the wiring.
		Product failure		Replace the product.
3	The switch output is OFF. The operation light is normal.	Incorrect wiring	Check the output wiring. Check if the load is directly connected to DC(+) or DC(-).	Check and correct the wiring.
		Incorrect SW output specification setting	Check the SW output specification setting. Check if the SW output is PNP while NPN is intended to be set, and vice versa.	Set the SW output specification again.
		Lead wire broken	Check if there is bending stress applied to any part of the lead wire. (bending radius, tensile force to the lead wire)	Correct the wiring. (Reduce the tensile force or increase the bending radius.)
		Product failure		Replace the product.
4	The switch output generates chattering.	Incorrect wiring	Check the wiring. Check if the brown and blue wires are connected to DC(+) and DC(-) respectively, and if the output line is secure (contact failure).	Correct the connection on the power cord and the plug.
		Incorrect pressure setting	(1) Check the set pressure value. (2) Check if the hysteresis range is small. (3) Check the delay time setting. Check if the delay time is too short.	(1) Adjust the set pressure value. (2) Make the hysteresis wider. (3) Set the delay time again.
		Product failure		Replace the product.
5	The switch output response is slow.	Incorrect pressure setting	Check the set pressure value. Check if the detected pressure and the set pressure values are the same or are too close.	Adjust the set pressure value. Ensure the set pressure value is not too close to the detected pressure value.





Problem No.	Problem	Problem possible causes	Investigation method	Countermeasures
6	<ul style="list-style-type: none"> •Over current error (Er1) is displayed. •System error (Er0, 4, 6, 7, 8, 9) is displayed. •"HHH" is displayed. •"LLL" is displayed. • Residual pressure error (Er3) is displayed. 	Excess current was applied to the output (Er1)	<ol style="list-style-type: none"> (1) Check if the output current is 80 mA or more. (2) Check if the connected load complies with the specification. Check if the load is short circuited. (3) Check if the relay without surge protection is connected. (4) Check if the wiring is in the same route as (or bundled together with) a high-voltage or power line. 	<ol style="list-style-type: none"> (1)(2) Connect the appropriate load. (3) Use a relay with a surge voltage suppressor or take measures to prevent surge. (4) Separate the wiring from the high-voltage and/or power line.
		Incorrect internal data processing of the product (Er0, 4, 6, 7, 8 and 9)	<ol style="list-style-type: none"> (1) Check if there is noise interference (such as static electricity). Check if there is a noise source nearby. (2) Check if the power supply voltage is in the range 12 to 24 VDC $\pm 10\%$. 	<ol style="list-style-type: none"> (1) Remove the noise and the noise source (or take measures to prevent noise interference), and reset the product (or turn off and then turn back on the power supply). (2) Supply power in the range 12 to 24 VDC $\pm 10\%$.
		Applied pressure is higher than the upper limit (HHH)	<ol style="list-style-type: none"> (1) Check if the pressure exceeds the upper limit of the set pressure range. (2) Check if foreign matter has entered the piping. 	<ol style="list-style-type: none"> (1) Reset applied pressure to a level within the set pressure range. (2) Take measures to prevent foreign matter from entering the piping.
		Applied pressure is lower than the lower limit (LLL)	<ol style="list-style-type: none"> (1) Check if the pressure exceeds the lower limit of the set pressure range. (2) Check if foreign matter has entered the piping. 	<ol style="list-style-type: none"> (1) Reset applied pressure to a level within the set pressure range. (2) Take measures to prevent foreign matter from entering the piping.
		Pressure is not atmospheric pressure when zero-clear is performed (Er3)	Check if the pressure exceeded the atmospheric pressure within $\pm 7\%$ F.S. ($\pm 3.5\%$ F.S. for compound pressure).	Release the applied pressure to atmospheric pressure, and retry the zero clear operation.
		Product failure		Replace the product.
		7	The display is unstable.	Incorrect power supply
Incorrect wiring	Check the power supply wiring. Check if the brown and blue wires are connected to DC(+) and DC(-) respectively, and if the wiring is secure.			Check and correct the wiring.
Factory line pressure is not stable	Check if the factory line pressure is changing.			If the fluctuation is not acceptable, the number of digits (display sensitivity) can be reduced by changing the display resolution. Digital filter setting may improve the condition.

Problem No.	Problem	Problem possible causes	Investigation method	Countermeasures
8	Applied voltage does not match with the displayed pressure value.	Incorrect pressure range setting	Check the pressure range setting. Check if the connected pressure sensor and the set pressure range are correct.	Select the correct pressure range.
9	<ul style="list-style-type: none"> •The display turns OFF. •Part of the display is missing. 	Incorrect power supply	Check if the power supply voltage is in the range 12 to 24 VDC \pm 10%.	Supply power in the range 12 to 24 VDC \pm 10%.
		Incorrect wiring	Check the power supply wiring. Check if the brown and blue wires are connected to DC(+) and DC(-) respectively, and if the wiring is secure.	Check and correct the wiring.
		Power saving mode	Check if power saving mode is selected.	Select the power saving mode again.
		Product failure		Replace the product.
10	Display flashes.	Incorrect wiring	(1) Check the power supply wiring. (2) Check if there is bending stress applied to any part of the lead wire.	(1) Check and correct the wiring. (2) Correct the wiring (bend radius and stress).
11	Pressure display is unstable when products are in close proximity to each other.	Variation within the display accuracy range	Check if the variation is within the display accuracy range.	Use the fine adjustment mode to adjust the display if the variation is within the display accuracy range.
		Product failure		Replace the product.
12	The display accuracy does not meet the specifications.	Foreign matter entered	Confirmed foreign matter entry or sticking to the piping port.	Use 5 μ m of filter to prevent foreign matter from entering or sticking. Discharge the condensate of the filter periodically.
		Air or liquid leakage	Check if air or liquid are leaking from the piping.	Rework the piping. If the tightening torque is exceeded, the mounting screws, brackets and the product may be damaged.
		Warming up inadequate	Check if the product satisfies the specified accuracy 10 minutes after supplying power.	After energizing, the display and output can drift. For precise pressure detection, allow the product to warm up for 10 to 15 minutes.
		Product failure		Replace the product.

Problem No.	Problem	Problem possible causes	Investigation method	Countermeasures
13	Display measurement unit cannot be changed.	Model selection (model selected does not have units selection function)	Check if the product number printed on the product indicates units selection function type.	Unit s selection function is not available for fixed to SI units type. (kPa↔MPa is available) *: The units selection function is not for use in Japan due to a new measurement law. *: Fixed to SI units: kPa, MPa
		Product failure		Replace the product.
14	Buttons do not work.	Key-lock mode is activated	Check if the key-lock function is turned on.	Check the key-lock function.
		Product failure		Replace the product.
15	The operation is unstable. (chattering)	Effect of line pressure fluctuation because hysteresis is too narrow or delay time of the switch is too short	(1) Check the set pressure values (hysteresis) (2) Check the delay time.	(1) Adjust the set pressure value. (2) Change the response time setting.
		Incorrect wiring/broken lead wire	(1) Check the power supply wiring. (2) Check if there is bending stress applied to any part of the lead wire. (bending radius, tensile force to the lead wire)	(1) Check and correct the wiring. (2) Correct the wiring. (Reduce the tensile force or increase the bending radius.)
		Product failure		Replace the product.

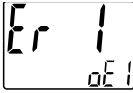
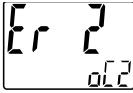
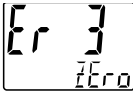
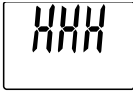
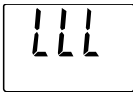
○Error indication function

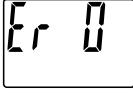
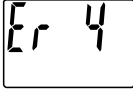
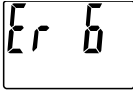
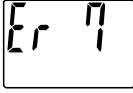
This function is to display error location and content when a problem or error has occurred.

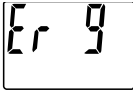
Error	Error displayed	Description	Measures
Over current error	 	The switch output load current is 80 mA or more.	Turn the power off and remove the cause of the over current. Then supply the power again.
Residual pressure error		During zero clear operation, pressure greater than $\pm 7\%$ F.S. ($\pm 3.5\%$ F.S. for compound pressure) is present. Note that the mode is returned to measurement mode automatically 1 second later. The zero clear range varies by $\pm 1\%$ F.S. due to variation between individual products.	Release the applied pressure to atmospheric pressure, and retry the zero clear operation.
Pressurizing error		Pressure exceeding the upper limit of the set pressure range is applied.	Reset applied pressure to a level within the set pressure range. Check the sensor connection and wiring.
		Pressure exceeding the lower limit of the set pressure range is applied. Sensor is not connected or wired incorrectly.	
Copy error		Fail to operate copy function.	Press the UP and DOWN buttons <u>1 second or longer</u> to recover from error. Try copy function after checking wiring, product model etc.
System error	     	Displayed if an internal data error has occurred.	Turn the power off and on again. If the failure cannot be solved, contact SMC.

If the error cannot be reset after the above measures are taken, or errors other than above are displayed, please contact SMC.

Specifications

Product No.		PSE3##A series		
Pressure spec.	Rated pressure range		Refer to the table for each pressure specification (page 79)	
	Display/set pressure range			
	Display/min. setting unit			
Electric spec.	Power supply voltage		12 to 24 VDC $\pm 10\%$, ripple max. 10% (p-p)	
	Current consumption		35 mA or less	
	Protection		Polarity protection	
Accuracy	Display accuracy		$\pm 0.5\%F.S.$ ± 1 digit (at ambient temperature 25 °C Constant temperature)	
	Repeatability		$\pm 0.1\%F.S.$ ± 1 digit	
	Analogue output accuracy (to displayed value)		$\pm 0.5\%F.S.$	
	Analogue output linearity		$\pm 0.2\%F.S.$	
	Temperature characteristics		$\pm 0.5\%F.S.$ (25 °C standard)	
Switch output	Output type		Select from NPN or PNP open collector 2 outputs.	
	Output mode		Select from hysteresis mode, window comparator mode, error output or switch output OFF.	
	Switch operation		Select from normal output or reversed output.	
	Maximum load current		80 mA	
	Maximum applied voltage (NPN output)		30 VDC	
	Internal voltage drop (Residual voltage)		NPN: 1 V or less (Load current 80 mA) PNP: 1.5 V or less (Load current 80 mA)	
	Delay time *1		1.5 ms or less (delay time available for anti-chattering function: 20, 100, 500, 1000, 2000, 5000 ms)	
	Hysteresis	Hysteresis mode		Variable from 0 *2
		Window comparator mode		
	Protection		Over current protection	
Analogue output	Voltage output	Output type *3	Voltage output: 1 to 5 V, Extended analogue output range: 0.6 to 1 V	
		Output impedance	Approx. 1 k Ω	
	Current output	Output type *3	Current output: 4 to 20 mA, Extended analogue output range: 2.4 to 4 mA	
		Load impedance	Max. load impedance: 300 Ω (at power supply voltage of 12 VDC) 600 Ω (at power supply voltage of 24 VDC) Min. load impedance: 50 Ω	
Analogue response time		50 ms or less		
Auto-shift input	Input type		Non-voltage input : 0.4 V or less	
	Input mode		Select from auto-shift, auto-shift zero	
	Input time		5 ms or more	
Sensor input	Input type		Voltage input: 1 to 5 VDC (Input impedance: 1 M Ω) Current input: 4 to 20 mA (Input impedance: 51 Ω)	
	Number of inputs		1 input	
	Connection method		Connector (e-CON)	
	Protection		Over voltage protection (up to a voltage of 26.4 V)	

Product No.		PSE3##A series
Display	Unit *4	Select from MPa, kPa, Pa, kgf/cm ² , bar, mbar, psi, inHg, mmHg or mmH ₂ O
	Display type	LCD
	Number of displays	3-screen display (Main display, sub display x 2)
	Display colour	1) Main display: Red/Green 2) Sub display: Orange
	Number of display digits	Main display: 4 digit (7-segments) Sub display: 4 digit (Upper 1 digit 11-segments, 7-segments for other)
	Operation light	LED is ON when switch output is ON (OUT1/OUT2: Orange)
Digital filter *5 *6		0, 10, 50, 100, 500, 1000, 5000 ms
Environment	Enclosure	IP40
	Withstand voltage	1000 VAC for 1 minute between terminals and housing
	Insulation resistance	50 MΩ or more between terminals and housing (with 500 VDC megger)
	Ambient temperature range	Operation: 0 to 50 °C, Storage: -10 to 60 °C (No condensation or freezing)
	Operating humidity range	Operation, Storage: 35 to 85%RH (No condensation)
Standard		UL/CSA (E216656), CE marked (EMC directive, RoHS directive)
Weight	Body	25 g (without power supply or output lead wires)
	Lead wire with connector	+39 g

*1: Value without digital filter (at 0 ms).

*2: If the sensor input fluctuates around the set value, the hysteresis must be set to a value more than the amount of fluctuation or chattering will occur.

*3: If the connected sensor does not have an extended analogue output range, there is no extended analogue output range available for this product.

*4: This setting is only available for models with the units selection function. Only MPa, kPa or Pa is available for models without this function (set by pressure range).

*5: The response time indicates when the set value is 90% in relation to the step input.

*6: Display, switch output and analogue response time are affected.

*7: Any products with tiny scratches, smears, or variations in the display colour or brightness, which does not affect the performance of the product, are verified as conforming products.

○ Table for each pressure specification

Applicable SMC pressure sensor	Rated pressure range	Display/set pressure range	Display/min. setting unit
PSE550	0 to 2 kPa	-0.2 to 2.1 kPa	0.001 kPa
PSE531, PSE541, PSE561	0 to -101 kPa	10 to -105 kPa	0.1 kPa
PSE533, PSE543, PSE563, PSE573	-100 to 100 kPa	-105 to 105 kPa	0.1 kPa
PSE532	0 to 100 kPa	-10 to 105 kPa	0.1 kPa
PSE564, PSE574	0 to 500 kPa	-50 to 525 kPa	1 kPa
PSE530, PSE540, PSE560, PSE570	0 to 1 MPa	-0.105 to 1.05 MPa	0.001 MPa
PSE575	0 to 2 MPa	-0.105 to 2.1 MPa	0.001 MPa
PSE576	0 to 5 MPa	-0.25 to 5.25 MPa	0.01 MPa
PSE577	0 to 10 MPa	-0.50 to 10.5 MPa	0.01 MPa

■Dimensions

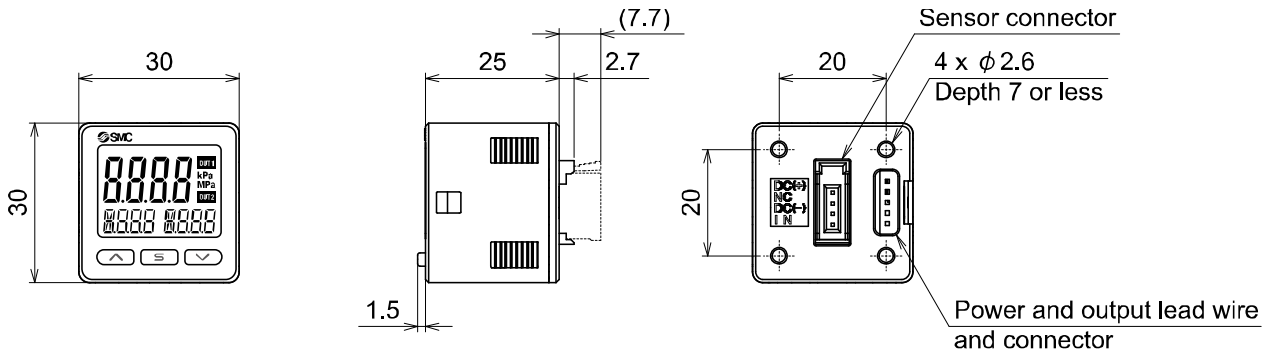

○Bracket (Part No: ZS-46-A1)

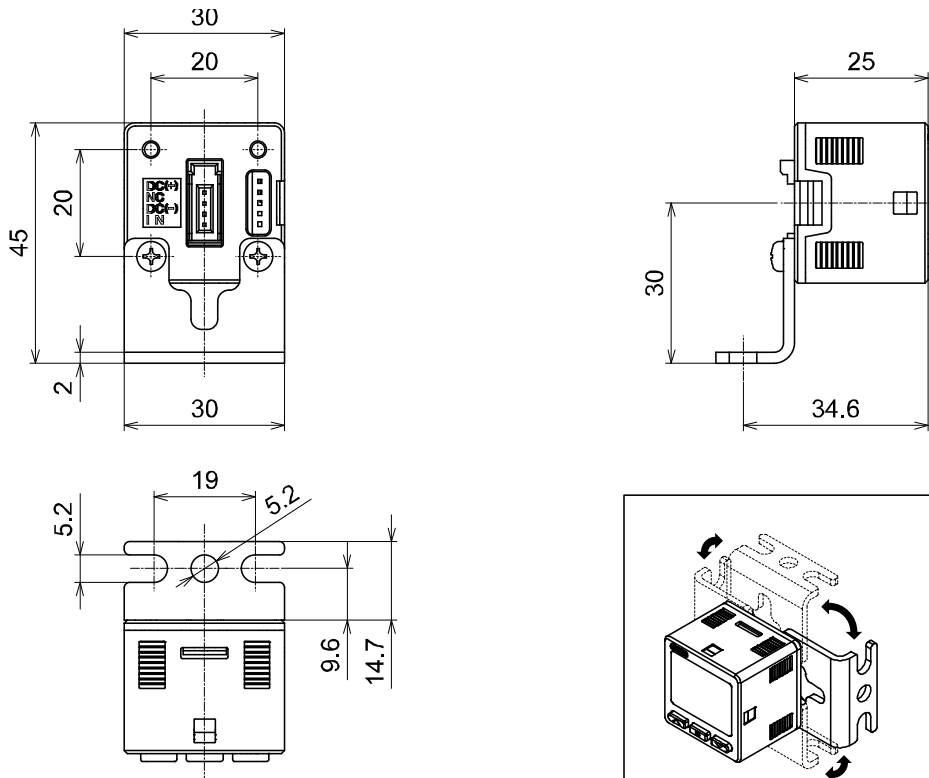

*Bracket can be mounted on 4 sides.

○Panel mount adapter (Part No: ZS-46-B)

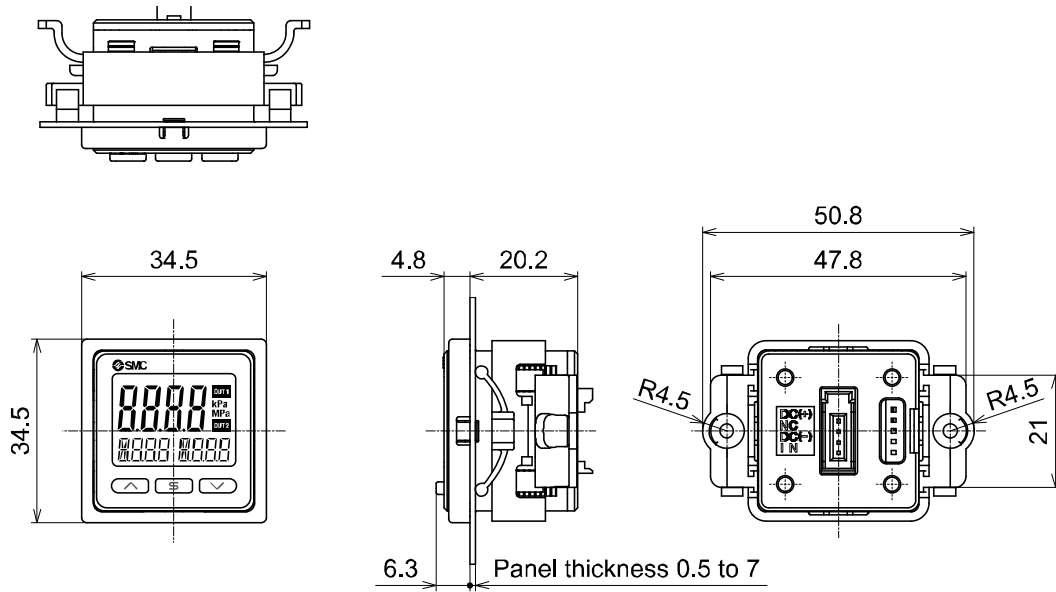

○Panel mount adapter + Front protective cover (Part No: ZS-46-D)

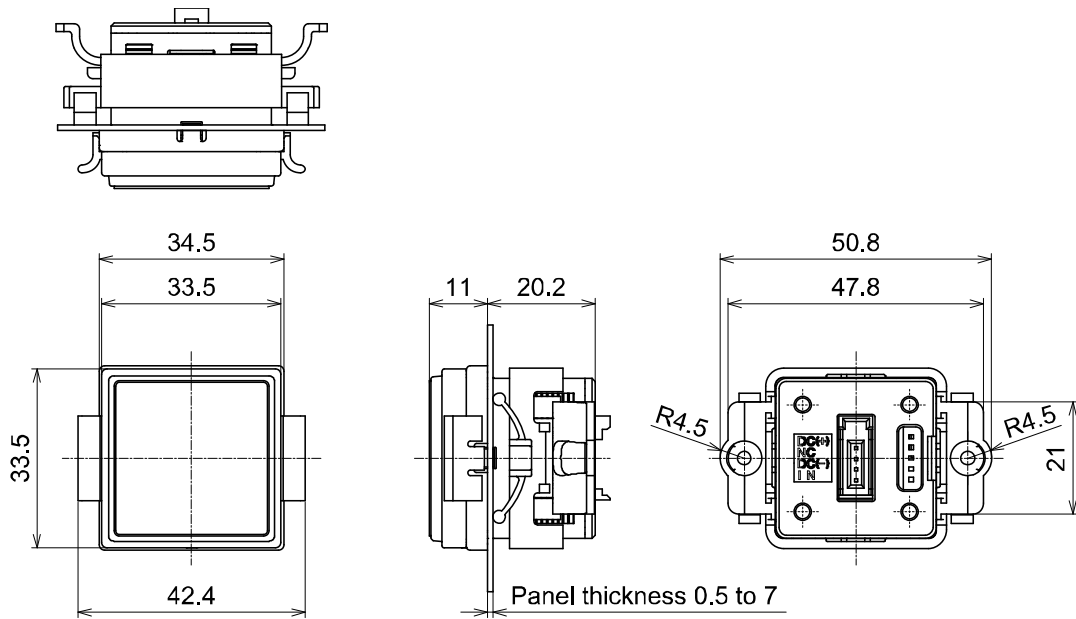

○Lead wire with connector (Part No: ZS-46-5L)

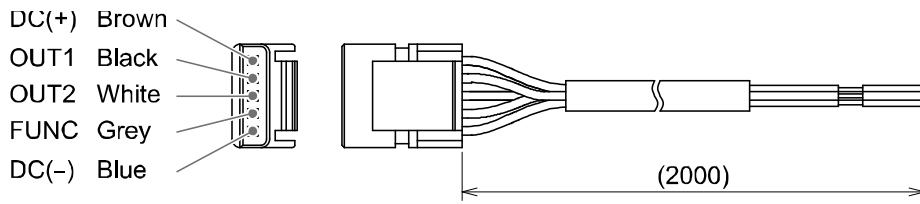

Conductor area		0.15 mm ² (AWG26)
Insulator	Outside diameter	1.0 mm
	Colour	Brown, Blue, Black, white, grey (5 core)
Sheath	Finished outside diameter	φ3.5

○ Panel cut-out dimensions

Mounting individually

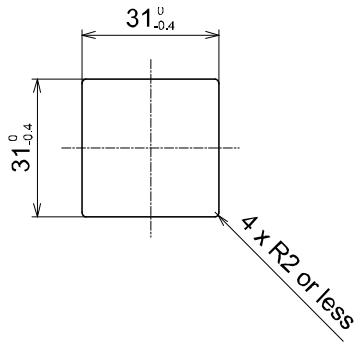

More than 2 pcs. (n pcs.) Close mounting

<Horizontal>

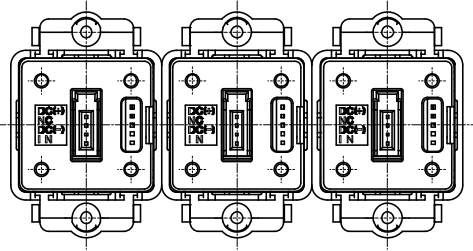
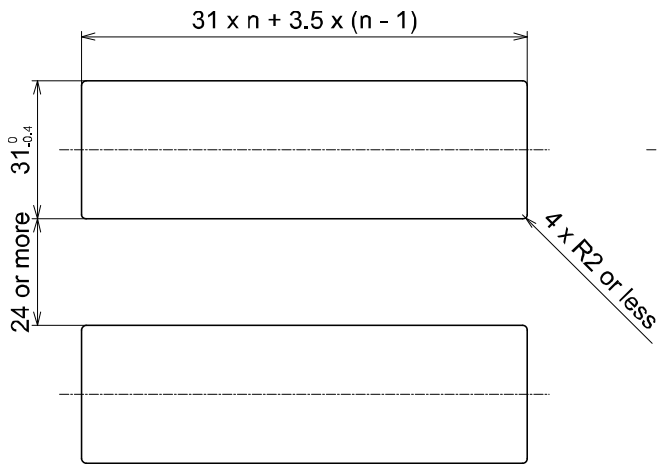

<Vertical>

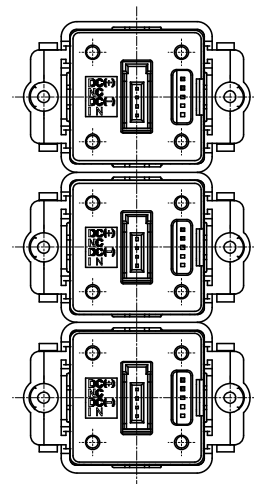
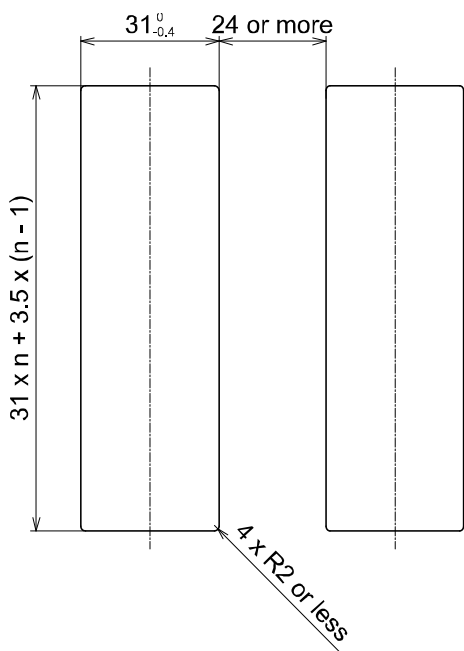

Revision history

- A: Contents revised in several places.
[February 2020]
- B: Contents revised in several places.
[February 2022]

SMC Corporation

4-14-1, Sotokanda, Chiyoda-ku, Tokyo 101-0021 JAPAN

Tel: + 81 3 5207 8249 Fax: +81 3 5298 5362

URL <https://www.smcworld.com>

Note: Specifications are subject to change without prior notice and any obligation on the part of the manufacturer.
© 2019-2022 SMC Corporation All Rights Reserved

