



Contact our sales office for delivery dates and prices as this is a special model.



P.G.Information (Specialized Product)

SP093X-001E  
P: RS

# Grease-free regulator

## AR(2 digits)-\*\*\*-\*-B-X2400(A)

SMC CORPORATION  
4-14-1, SOTO-KANDA,  
CHIYODA-KU,  
TOKYO 101-0021, JAPAN  
URL <http://www.smcworld.com>

**Features: Ideal for applications where usage of grease is unacceptable with grease-free wetted parts.**

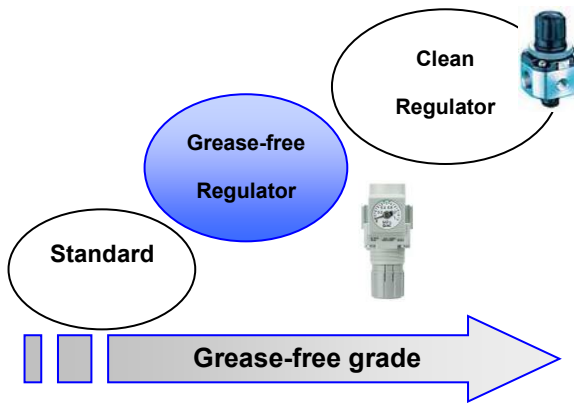

Remarks  
-X2400(A) is assembled in a normal environment.

Piping example:

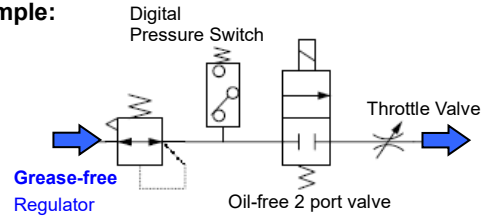

Application: Use together with ionizer, cyclone pad or levitation rail.

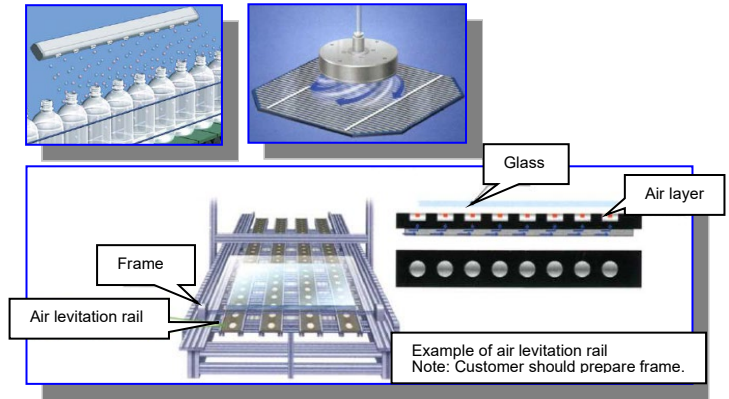

## How to Order :

**AR 30 - F 03 BG - N - B - X2400 A**

Regulator ●

Body size ●

20
25
30
40
50
60

Thread type ●

Nil	R c
N	N P T
F	G

Port size ●

Symbol	Port size	20	25	30	40	50	60
01	1/8	●	-	-	-	-	-
02	1/4	●	●	●	●	-	-
03	3/8	-	●	●	●	-	-
04	1/2	-	-	-	●	Note1) ●	-
06	3/4	-	-	-	●	●	Note1) ●
10	1	-	-	-	-	●	●

● Grease-free

● Semi-standard

Symbol	Fluid contact part cleaning	Pressure gauge
Nil	Yes	Oil-free
A	No	General

● Cleaning/Pressure gauge

Symbol	Description	Applicable model
Nil	-	AR20~60
N	Non-relief	AR20~60
R	Flow direction: Right to left	AR20~60
Y	Upward	AR20~60
Z	Name plate and pressure gauge in imperial units: psi	AR20~60

● Options

Symbol	Description	Applicable model
Nil	-	AR20~60
B	With bracket	AR20~60
E	Square embedded type pressure gauge	AR20~60
G	Round type pressure gauge	AR20~60
H	With set nut	AR20~40

Note 1: Additions to the standard type.

## Options / Part No. :

Option		Model	AR20(K)	AR25(K)	AR30(K)	AR40(K)	AR40(K)-06	AR50(K)	AR60(K)
Bracket assembly <sup>Note 1)</sup>			AR23P-270AS	AR28P-270AS	AR33P-270AS	AR43P-270AS		AR52P-270AS <sup>Note 2)</sup>	
Set nut			AR23P-260S	AR28P-260S	AR33P-260S	AR43P-260S		— <sup>Note 3)</sup>	— <sup>Note 3)</sup>
Press- ure gauge	Round <sup>Note 4)</sup> type	X2400	G46E-10-□01						
		X2400A	G36-10-□01			G46-10-□01			
	Square <sup>Note 5)</sup> embedded type	X2400	GC3-10AS-X2144 [GC3P-010AS (Pressure gauge cover only)]						
		X2400A	GC3-10AS-X2143 [GC3P-010AS ((Pressure gauge cover only)]						

Note 1: Assembly of a bracket and nuts.

Note 2: Assembly of a bracket and 2 mounting screws.

Note 3: Please consult with SMC regarding the set nuts for the AR50(K) and AR60(K).

Note 4: □ in part numbers for a round pressure gauge indicates a type of connection thread. No indication is necessary for R; however, indicate N for NPT. Please contact SMC regarding the connection thread NPT and pressure gauge supply for psi unit specifications.

Note 5: Including one O-ring and 2 mounting screws. [ ]: Please gauge cover only.

## Specifications :

New series (X type)	Specifications						
	Grease		Fluid contact part cleaning	Pressure gauge	Rubber material (low density ozone resistant)		
	Wetted part	Adjustment screw (Non wetted part)			Main valve	Diaphragm	Others Rubber parts
AR 20~60							
X2400	Grease- free	Molykote grease BR2 plus	Yes	Oil-free	HNBR	Weatherable NBR	HNBR
X2400A	Grease- free		No	General			

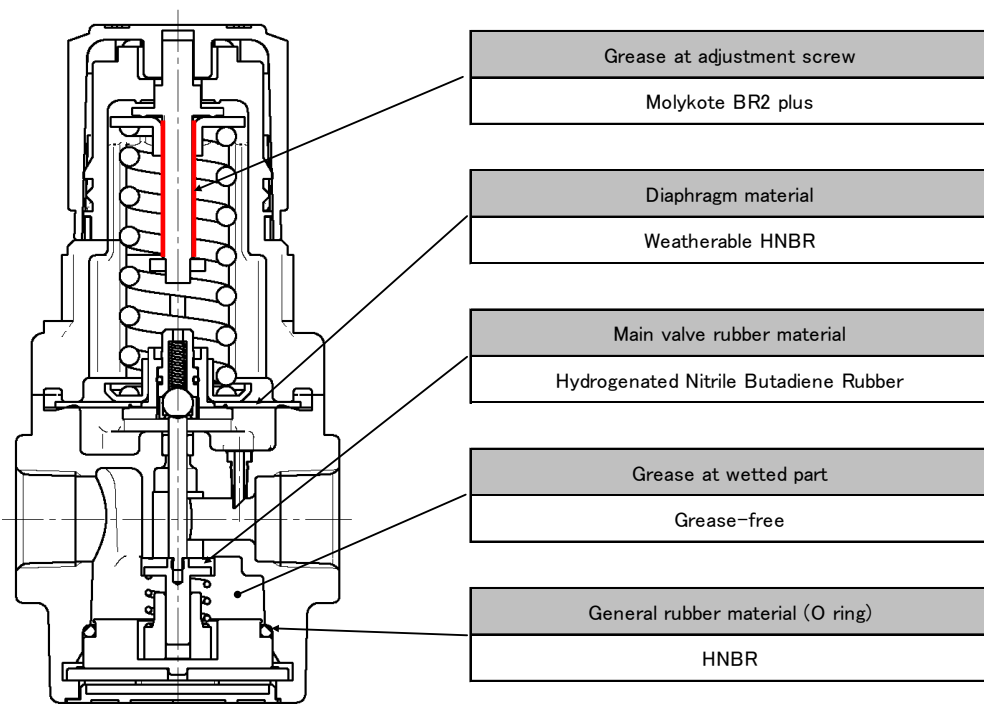

AR20-X2400

Rc 1/8

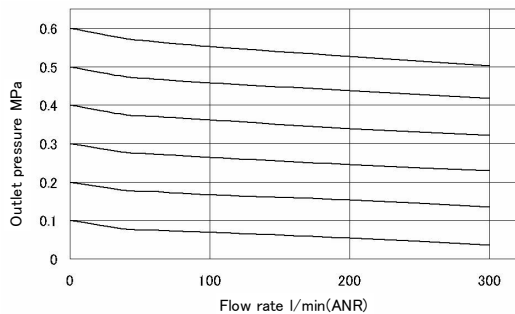

Rc 1/4

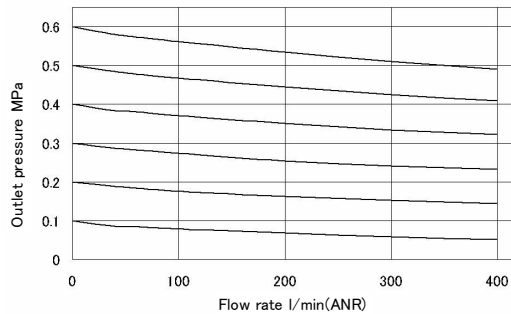

AR25-X2400

Rc 1/4

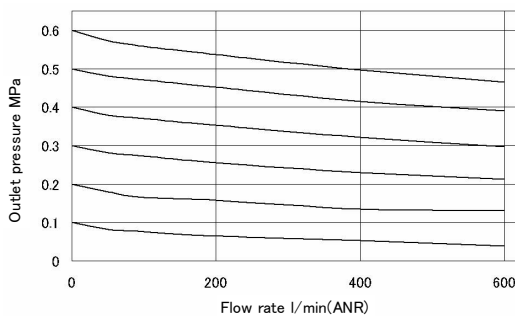

Rc 3/8

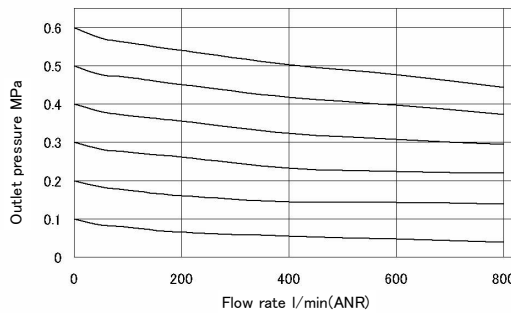

AR30-X2400

Rc 1/4

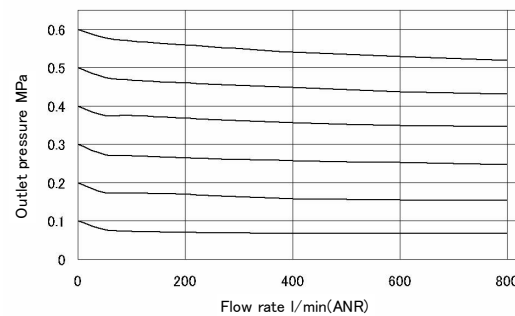

Rc 3/8

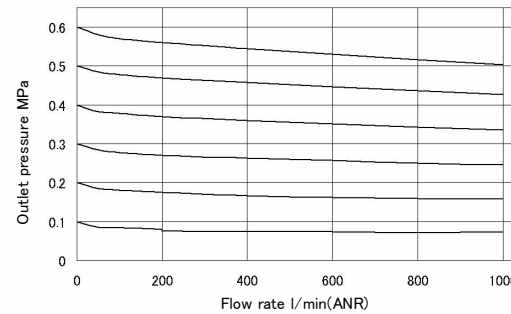

AR40-X2400

Rc 1/4

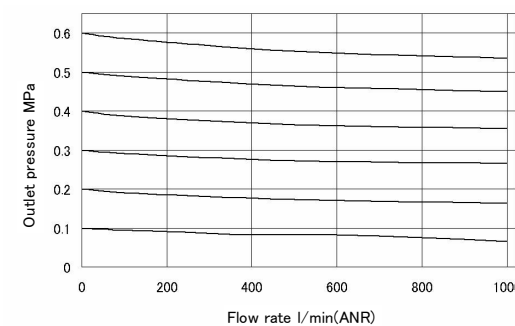

Rc 3/8

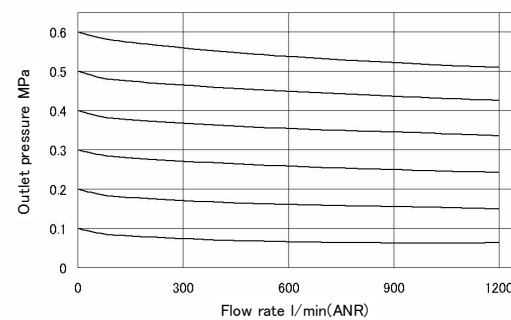

Rc 1/2

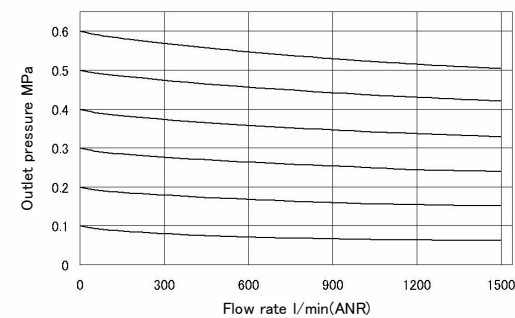

Rc 3/4

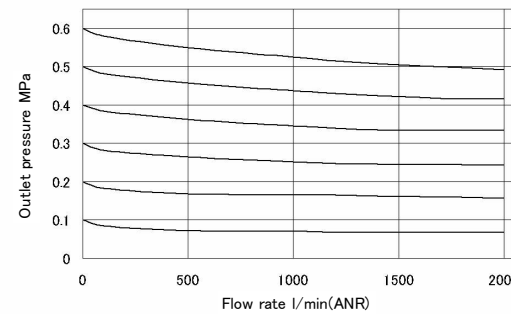

**AR50-X2400**

Rc 1/2

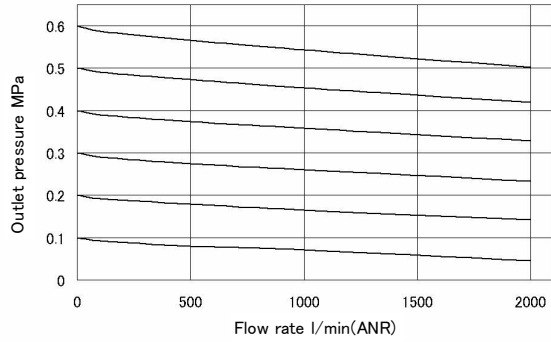

Rc 3/4

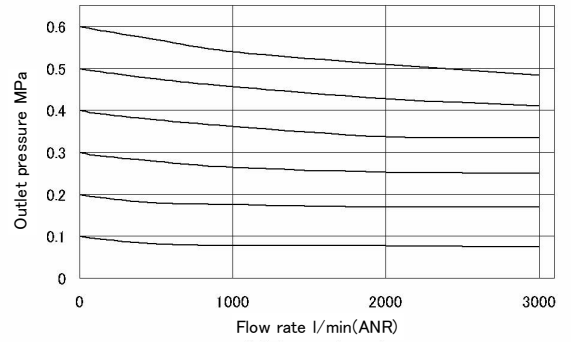

Rc 1

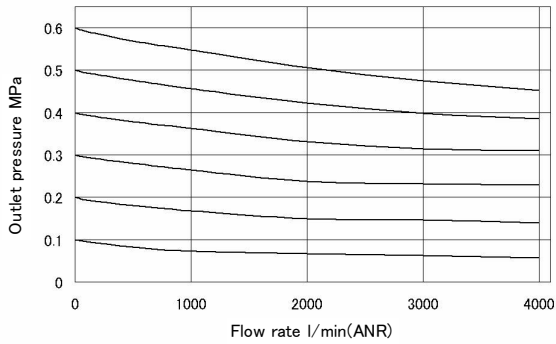

**AR60-X2400**

Rc 3/4

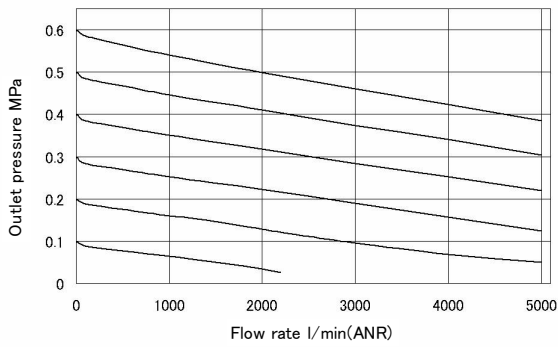

Rc 1

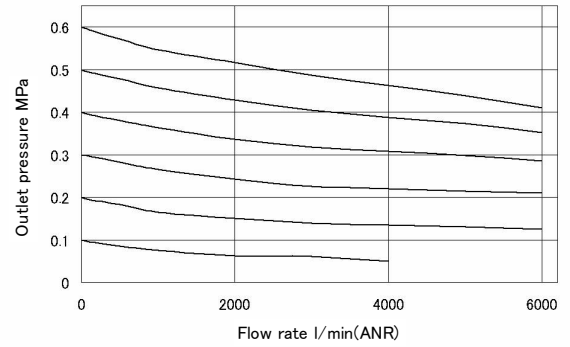

● Pressure Characteristics

Conditions : Inlet pressure 0.7MPa, Outlet pressure 0.2MPa, Flow rate 20 L/min(ANR)

AR20-X2400

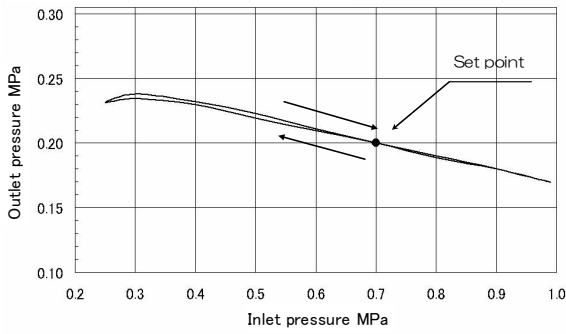

AR25-X2400

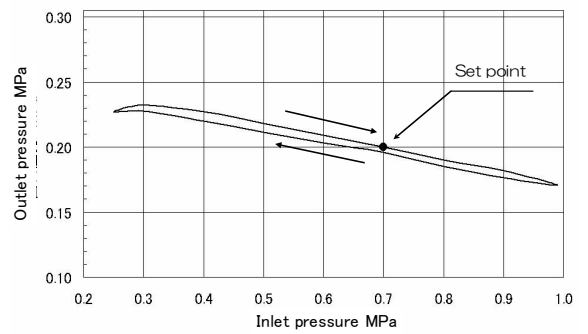

AR30-X2400

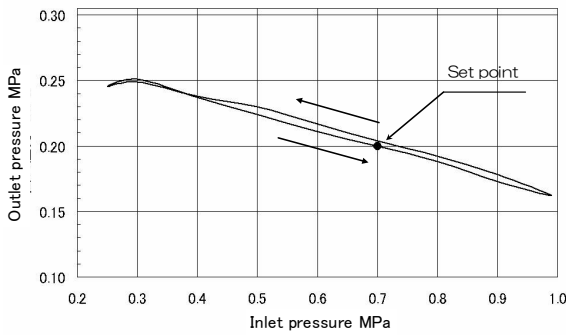

AR40-X2400

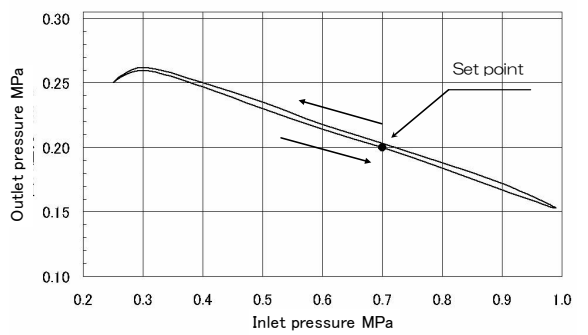

AR50-X2400

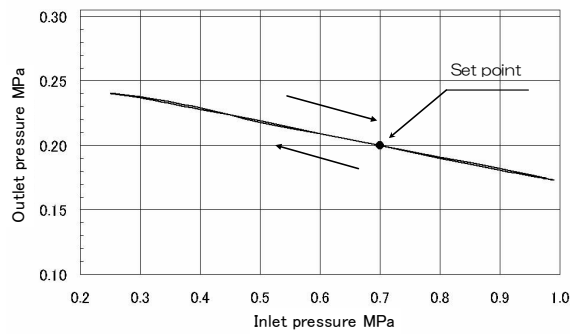

AR60-X2400

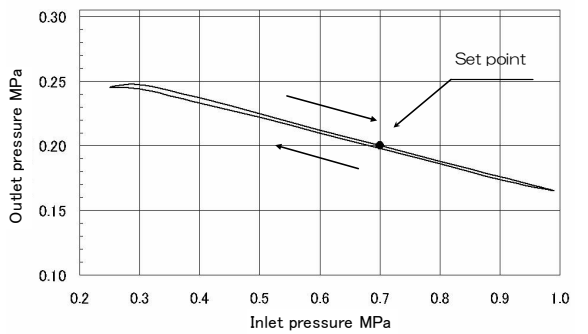

# Dimensions: mm

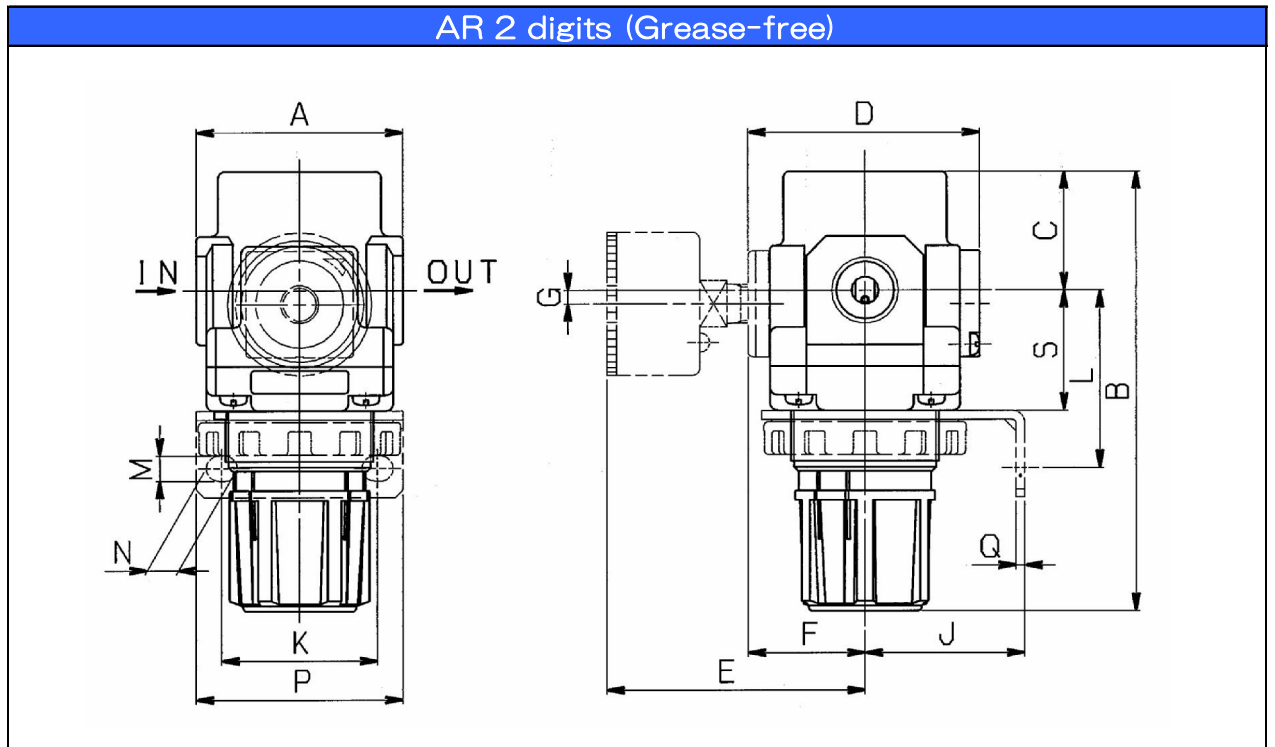

Model	Port size	A	B	C	D	E	F	G	J	K	L	M	N	P	Q	S
AR20-X2400	1/8,1/4	40	94	26.5	57	65	29.5	Note) <sub>2</sub>	30	34	44	5.4	15.4	55	2.3	25
AR25-X2400	1/4,3/8	53	101	28	55	64	28.5	0	30	34	44	5.4	15.4	55	2.3	26
AR30-X2400	1/4,3/8	53	116	31	59	66	30.5	3.5	41	40	46	6.5	8	53	2.3	31
AR40-X2400	1/4,3/8,1/2	70	128	36	68	74	35	3.5	50	54	54	8.5	10.5	70	2.3	35.5
AR40-06-X2400	3/4	75	129	36	68	74	35	3	50	54	56	8.5	10.5	70	2.3	37
AR50-X2400	1/2,3/4,1	90	169	43	87	84	44.5	3.3	70	66	65.8	11	13	90	3.2	-
AR60-X2400	3/4,1	95	176	46	87	84	44.5	3.3	70	66	65.8	11	13	90	3.2	-

Note: Only for AR20, pressure gauge mounting position is above the center of the piping.

## Clean series

Clean One-touch Fittings For Blowing KP



Ref. model No.: KPH06-01

Zero Differential Pressure Type Pilot Operated 2 Port Solenoid Valve VXZ



Ref. model No.: VXZ230AAZ(oil-free)

Speed Controller with One-touch Fitting AS -X21 [Grease-free (Seal : Fluorine Coating)+Throttle Valve (Without Check Valve)]



Ref. model No.: AS2201F-01-04SA-X21

⚠ Caution To ensure the safest possible operation of this product, please be sure to thoroughly read the "Safety Instructions" in our "Best Pneumatics" catalog before use.