

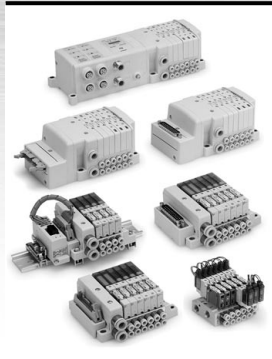



Series 10-S0700 5 Port Solenoid Valve

Variations

	S kit Serial Transmission (Fieldbus System)					
	EX180 For Output Serial Transmission System	EX260 For Output Serial Transmission System	EX500 Gateway-type Serial Transmission System	EX510 Gateway-type Serial Transmission System	EX250 For Input/Output Serial Transmission System	EX600 For Input/Output Serial Transmission System
	Applicable Protocol · DeviceNet® · CC-Link	Applicable Protocol · DeviceNet® · PROFIBUS DP · CC-Link · EtherNet/IP™ · EtherCAT · PROFINET · Ethernet POWERLINK	Applicable Protocol · PROFIBUS DP · EtherNet/IP™	Applicable Protocol · DeviceNet® · PROFIBUS DP · CC-Link	Applicable Protocol · DeviceNet® · PROFIBUS DP · CANopen · AS-Interface · ControlNet™ · EtherNet/IP™	Applicable Protocol · DeviceNet® · PROFIBUS DP · CC-Link · EtherNet/IP™ · EtherCAT · PROFINET * Compatible with wireless systems
Slim Compact Plug-in Manifold Bar Base 	 Page 423-2	—	—	 Page 425	—	—
Plug-in Manifold Stacking Base 	—	 Page 423-6	 Page 447	—	 Page 449	 Page 451
Plug Lead Manifold Bar Base 	—	—	—	 Page 495	—	—

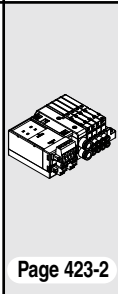
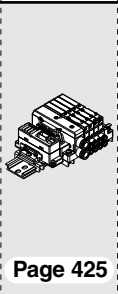
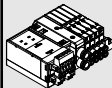
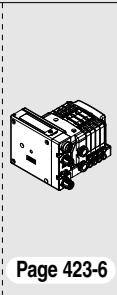
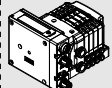
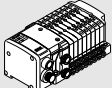
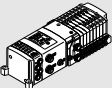
	F kit D-sub Connector	P kit Flat Ribbon Cable	T kit Terminal Block Box	L kit Lead Wire	M kit Circular Connector	C kit Connector
	MIL Standard	MIL Standard · 26 pins, 20 pins				
	 Page 429	 Page 433	—	—	—	—
	 Page 457	 Page 461	 Page 469	 Page 473	 Page 477	—
	—	—	—	—	—	 Page 491

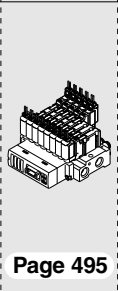
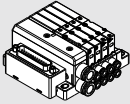
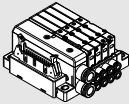
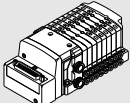
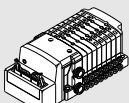
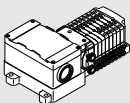
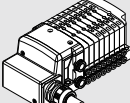
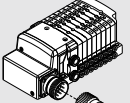
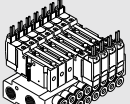
Directional
Control Valves

Air Cylinders

Rotary Actuators

Air Grippers

Air Preparation
Equipment

Modular F. R.

Pressure Control
Equipment

Fittings & Tubing

Flow Control
Equipment

Pressure Switches/
Pressure Sensors

Options

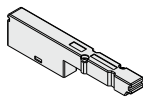
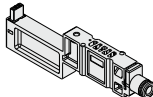
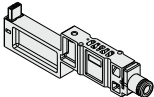
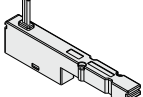

Slim Compact Plug-in Manifold Bar Base / Options

<p>Blanking plate SS0700-10A-3 Page 440</p> 	<p>Individual SUP spacer S0700-P-3-C Page 440</p> 	<p>Individual EXH spacer S0700-R-3-C Page 440</p> 	<p>Blanking plate with output SS0700-3C- Page 440</p> 
---	---	---	---

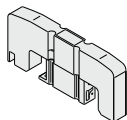
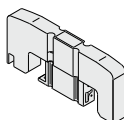
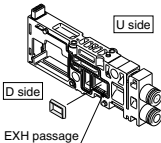
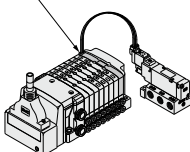
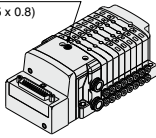
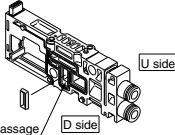
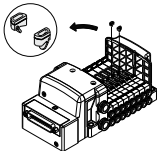
Plug-in Manifold Stacking Base / Options

<p>Blanking plate SS0700-10A-1 Page 481</p> 	<p>Individual SUP/EXH spacer SS0700-PR-1 Page 481</p> 	<p>EXH block plate SS0700-B-R Page 482</p> 	<p>Blanking plate with output SS0700-1C- Page 483</p> <p>Blanking plate with output</p> 
<p>External pilot [-R] Page 481</p> <p>External pilot port (M5 x 0.8)</p> 	<p>SUP block plate SS0700-B-P Page 482</p> 	<p>Back pressure check valve [-B] SS0700-7A-1 Page 482</p> 	

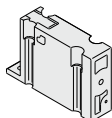
Plug Lead Manifold Bar Base / Options

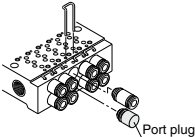
<p>Blanking plate SS0700-10A-5 Page 497</p> 	<p>Individual SUP spacer SS0700-P-5-M5 Page 497</p>  <p>* Compatible with 8.5 mm pitch only</p>	<p>Individual EXH spacer SS0700-R-5-M5 Page 497</p>  <p>* Compatible with 8.5 mm pitch only</p>	<p>Port plug VVQ0000-CP Page 497</p>  <p>Port plug</p>
---	--	--	--

External pilot [-R]
Page 441

External pilot port
(M5 x 0.8)

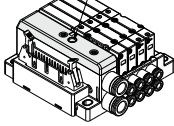

DIN rail mounting bracket
SS0700-57A-3 Page 441

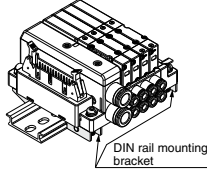

Port plug
VVQ000-CP Page 483

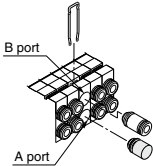

Blanking plug
(For One-touch fitting)
KJP-02
KQ2P-23/04/06 Page 483

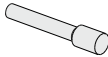

DIN rail mounting bracket
SS0700-57A-□ Page 483

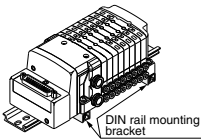

Name plate [-N]
SS0700-N-Station (1 to Max. stations)
Page 484

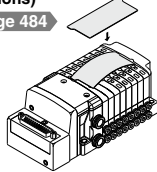

External pilot [-R]
Page 497

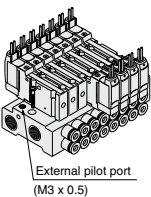

External pilot port
(M3 x 0.5)

Blanking plug
(For One-touch fitting)
KJP-02
KQ2P-23/04/06 Page 498

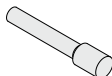

Directional
Control Valves

Air Cylinders

Rotary Actuators

Air Grippers

Air Preparation
Equipment

Modular F. R.

Pressure Control
Equipment

Fittings & Tubing

Flow Control
Equipment

Pressure Switches/
Pressure Sensors

Valve Specifications

Valve Specifications

Model

Series	Actuation type	Model	Flow rate characteristics						Note 2) Response time (msec)	Weight (g)	
			1→4/2 (P→A/B)			4/2→5/3 (A/B→R1/R2)					
			C [dm ³ /(s·bar)]	b	Cv	C [dm ³ /(s·bar)]	b	Cv			
Slim compact Plug-in manifold Bar base	2-position	Single	S0711	0.39	0.39	0.11	0.37	0.39	0.10	18 or less	36
		Double	S0721	0.39	0.39	0.11	0.37	0.39	0.10	10 or less	41
	4-position	Dual 3-port valve	S07 ^A _{B1} _C	0.34	0.34	0.09	0.33	0.33	0.08	18 or less	41
Plug-in manifold Stacking base	2-position	Single	S0710	0.39	0.39	0.11	0.37	0.39	0.10	18 or less	30
		Double	S0720	0.39	0.39	0.11	0.37	0.39	0.10	10 or less	38
	4-position	Dual 3-port valve	S07 ^A _{B0} _C	0.34	0.34	0.09	0.33	0.33	0.08	18 or less	38
Plug lead manifold Bar base	2-position	Single	S0715	0.39	0.39	0.11	0.37	0.39	0.10	12 or less	28
		Double	S0725	0.39	0.39	0.11	0.37	0.39	0.10	10 or less	36
	4-position	Dual 3-port valve	S07 ^A _{B5} _C	0.34	0.34	0.09	0.33	0.33	0.08	12 or less	36

Note 1) Values for cylinder port fitting size C6

Note 2) Based on JIS B 8375-1993 (Supply pressure: 0.5 MPa, with indicator light and surge voltage suppressor, clean air. This will change depending on pressure and air quality.) The value when ON for the double type.

Specifications

Valve specifications	Valve construction		Rubber seal
	Fluid		Air/Inert gas
	Max. operating pressure		0.7 MPa
	Min. operating pressure		0.2 MPa
	Ambient and fluid temperature		-10 to 50°C ^{Note 1)}
	Max. operating cycle		5 Hz
	Pilot valve exhaust method		Common exhaust ^{Note 2)}
	Pilot valve manual override		Push type
	Lubrication		Not required
	Impact/Vibration resistance ^{Note 3)}		30/100 m/s ²
Electrical specifications	Enclosure		IP40
	Coil rated voltage		24 VDC
	Allowable voltage fluctuation		±10% of rated voltage
	Coil insulation type		Class B or equivalent
	Power consumption (Current)	24 VDC	DC 0.35 W (15 mA)

Note 1) Use dry air to prevent condensation when operating at low temperatures.

Note 2) Since the pilot EXH of valves with the external pilot specification also has a common exhaust specification, the 3(R) port should be released to the atmosphere.

Note 3) Impact resistance: No malfunction occurred when it was tested with a drop tester in the axial direction and at right angles to the main valve and armature in both energized and de-energized states once for each condition.

Vibration resistance: No malfunction occurred in a one-sweep test between 8.3 and 2000 Hz. Test was performed in both energized and de-energized states in the axial direction and at right angles to the main valve and armature.

Manifold Specifications

Manifold Specifications

Model

Base model		Piping specifications		Connection type	Note 1) Applicable stations	Note 3) 5-station weight (g)	Note 3) Addition per station (g)
		Port size					
		1(P), 3(R)	4(A), 2(B)				
Slim compact Plug-in manifold Bar base	10-SS0751-□□□□	C6 (ø6) C8 (ø8) N7 (ø1/4") N9 (ø5/16") Option (Direct EXH outlet with built-in silencer)	C2 (ø2) C3 (ø3.2) C4 (ø4) N1 (ø1/8") N3 (ø5/32")	S kit: Serial transmission (EX510)	Max. 16 stations	320	19 Note 7)
				F kit: D-sub connector	Max. 24 stations	185	17
				P kit: Flat ribbon cable	Max. 24 stations	181	17
Plug-in manifold Stacking base	10-SS0750-□□□□	C6 (ø6) C8 (ø8) N7 (ø1/4") N9 (ø5/16") Option (Direct EXH outlet with built-in silencer)	C2 (ø2) C3 (ø3.2) C4 (ø4) N1 (ø1/8") N3 (ø5/32")	S kit: Serial transmission (EX500)	Max. 16 stations	360	20
				S kit: Serial transmission (EX250)	Max. 24 stations Note 2)	560 Note 4)	20
				F kit: D-sub connector	Max. 24 stations	330	20
				P kit: Flat ribbon cable	Max. 24 stations	325	20
				T kit: Terminal block box	Max. 20 stations	660	20
				L kit: Lead wire	Max. 24 stations	455 Note 5)	20
M kit: Circular connector	Max. 24 stations	390	20				
Plug lead manifold Bar base	10-SS0755-□□C□C (Manifold pitch: 8.5 mm*)	Rc1/8	M5 thread C2 (ø2) C3 (ø3.2) C4 (ø4) N1 (ø1/8") N3 (ø5/32")	C kit: Connector	Max. 20 stations	115	20
				S kit: Serial transmission (EX510)	Max. 16 stations	115	20
Single unit	10-S07□5-□-M5	M5 thread	M5 thread	Connector kit	—	14 Note 6)	

Note 1) Maximum stations for mixed single and double wiring (special wiring specifications)

Note 2) Differs depending on the serial unit type. For details, refer to page 449.

Note 3) Weight excluding valve. Refer to page 421 for valve weight.

Note 4) Weight with one input block

Note 5) Weight with lead wire length 0.6 m

Note 6) Weight of sub-plate only. Refer to page 421 for valve weight.

Note 7) Including DIN rail weight

* The manifold pitch 7.5 mm type is available as special order.

Directional Control Valves

Air Cylinders

Rotary Actuators

Air Grippers

Air Preparation Equipment

Modular F. R.

Pressure Control Equipment

Fittings & Tubing

Flow Control Equipment

Pressure Switches/ Pressure Sensors

Cylinder Speed Chart

Use as a guide for selection.
Please confirm the actual conditions with
SMC Model Selection Software.

Base Mounted

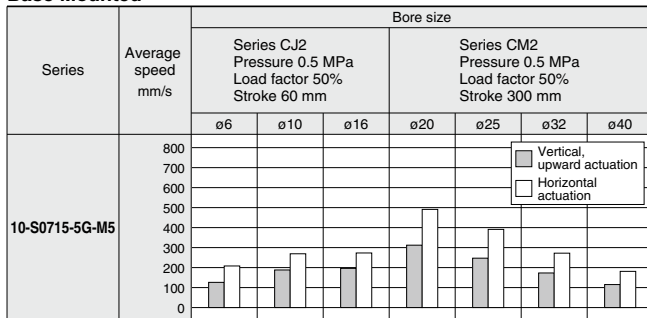

- * It is when the cylinder is extending that is meter-out controlled by speed controller which is directly connected with cylinder, and its needle valve with being fully open.
- * The average velocity of the cylinder is what the stroke is divided by the total stroke time.
- * Load factor: ((Load mass x 9.8)/Theoretical force) x 100%

Conditions

Base mounted		Series CJ2	Series CM2
10-S0715-5G-M5	Tubing diameter x Length	ø6 x 1 m	
	Speed controller	AS2001F-06	AS2301F-06
	Silencer	AN120-M5	

Symbol

Model	Actuation type	Symbol
10-S0710 10-S0711 10-S0715	2-position single	
10-S0720 10-S0721 10-S0725	2-position double	
10-S07A0 10-S07A1 10-S07A5	4-position dual 3-port (N.C. + N.C.) [Exhaust center]	
10-S07B0 10-S07B1 10-S07B5	4-position dual 3-port (N.O. + N.O.) [Pressure center]	
10-S07C0 10-S07C1 10-S07C5	4-position dual 3-port (N.C. + N.O.)	

Slim Compact Bar Base
Serial Transmission
S kit

Slim Compact
Bar Base

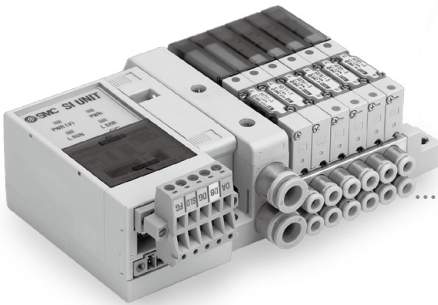

For Output
Serial Transmission System
EX180

Page 423-2



Directional
Control Valves

Air Cylinders

Rotary Actuators

Air Grippers

Air Preparation
Equipment

Modular F. R.

Pressure Control
Equipment

Fittings & Tubing

Flow Control
Equipment

Pressure Switches/
Pressure Sensors



10-S0700 Series Slim Compact Bar Base

Kit (Serial Transmission) EX180 (For Output) Serial Transmission System

How to Order Manifold

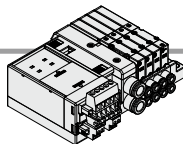

10-SS0751 - 08 C4 C8 SDV2 [] [] - []

Stations

Symbol	Stations
02	2 stations
⋮	⋮
32 ^{*1}	32 stations

*1: The maximum number of stations will be different depending on the wiring specifications.

Cylinder port size

Symbol	Port size	
C2	With ø2 One-touch fitting	Metric
C3	With ø3.2 One-touch fitting	
C4	With ø4 One-touch fitting	Inch
N1	With ø1/8" One-touch fitting	
N3	With ø5/32" One-touch fitting	

P, R port size

Symbol	Port size	
C6	With ø6 One-touch fitting	Metric
C8	With ø8 One-touch fitting	
N7	With ø1/4" One-touch fitting	Inch
N9	With ø5/16" One-touch fitting	

*: If an inch size cylinder port is selected, select inch size piping connections for the P and R ports as well.

SI Unit Part No.

Symbol	Component module/Communication connector	Common specification	SI unit part no.	Output stations
V2	CC-Link (32 points)	NPN output (Positive common)	EX180-SMJ3	Max. 32 ^{*1}
V2N	T-branch type	PNP output (Negative common)	EX180-SMJ5	
V2A	CC-Link (32 points)	NPN output (Positive common)	EX180-SMJ3A	
V2AN	Straight type	PNP output (Negative common)	EX180-SMJ5A	Max. 32 ^{*1}
Q2	DeviceNet® (32 points)	NPN output (Positive common)	EX180-SDN3	
Q2N	T-branch type	PNP output (Negative common)	EX180-SDN5	
Q2A	DeviceNet® (32 points)	NPN output (Positive common)	EX180-SDN3A	Max. 16 ^{*1}
Q2AN	Straight type	PNP output (Negative common)	EX180-SDN5A	
Q3	DeviceNet® (16 points)	NPN output (Positive common)	EX180-SDN4	
Q3N	T-branch type	PNP output (Negative common)	EX180-SDN6	Max. 16 ^{*1}
Q3A	DeviceNet® (16 points)	NPN output (Positive common)	EX180-SDN4A	
Q3AN	Straight type	PNP output (Negative common)	EX180-SDN6A	

*1: Single wiring

Kit type

Symbol	Specifications
SD0	Without SI unit
SDV2	CC-Link (32 points)
SDQ2	DeviceNet® (32 points)
SDQ3	DeviceNet® (16 points)

*: Please contact SMC for SI unit specifications.

Option

Symbol	Specifications
Nil	None
D	With DIN rail (Rail length: Standard)
D0	Without DIN rail (With bracket)
D□	With DIN rail Designated length (□: Station)
K ^{*1}	Special wiring specifications (Except double wiring)
R ^{*2}	External pilot

- *1: Indicate the wiring specifications for mixed single and double wirings.
- *2: For details, refer to page 481.
- *: When two or more options are specified, indicate them alphabetically.
Example) -KR
- *: For manifold optional parts, refer to pages 481 to 484.
- *: For manifold exploded view, refer to page 487.

Refer to the **Web Catalog** and the Operation Manual for the details of the EX180 Integrated-type (For Output) Serial Transmission System. Please download the Operation Manual via our website, <http://www.smcworld.com>

- *: The maximum number of stations is determined by the total number of solenoids.
For mixed single and double wirings, enter -K to the order code options.
- *: For the 10-S0700 series, SI unit models EX180-SDN1, EX180-SDN2, or EX180-SMJ1 cannot be selected as S kit (SDQ□, SDV2).

Type of actuation	Single	Double, Dual 3-port
Number of solenoids	1	2

How to Order Manifold Assembly

Example Serial transmission kit

Specify the part numbers for valves and options together beneath the manifold base part number.

- * 10-SS0751-08C4C8SDQ2 ... 1 set - Manifold base part no.
- * 10-S0711-5 3 sets - Valve part no. (Stations 1 to 3)
- * 10-S0721-5 2 sets - Valve part no. (Stations 4 to 5)
- * 10-S07A1-5 2 sets - Valve part no. (Stations 6 to 7)
- * 10-SS0700-10A-3 ... 1 set - Blanking plate part no. (Station 8)

Prefix the asterisk to the part numbers of the solenoid valve etc. Write sequentially from the 1st station on the D side. When part numbers written collectively are complicated, specify on the manifold specification sheet.

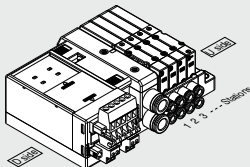

How to Order Valves

10-S07 1 1 [] - 5

Type of actuation

Symbol	Specifications
1	2-position single
2	2-position double
A	4-position dual 3-port (N.C. + N.C.) [Exhaust center]
B	4-position dual 3-port (N.O. + N.O.) [Pressure center]
C	4-position dual 3-port (N.C. + N.O.)

*: For symbol, refer to page 652.

Voltage: 24 VDC

Function

Symbol	Specifications
Nil	Standard
R	External pilot ^{*1}

*1: Not compatible with dual 3-port valves. The 3(R) port is open to the atmosphere. (Cannot be used for applying pressure or vacuum)

Base mounted plug-in

Slim Compact Bar Base
EX180 (For Output) Serial Transmission System *10-S0700 Series*

10-SS0751
S kit (Serial transmission: EX180)

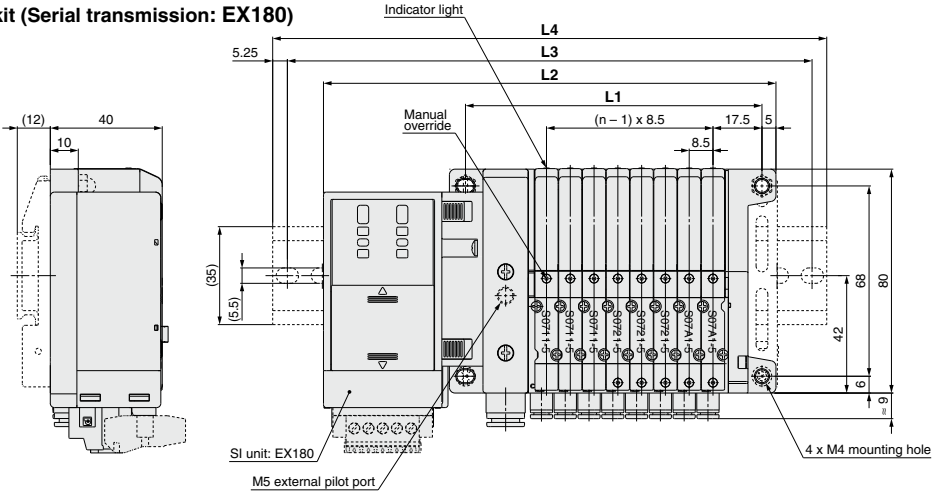

D side Stations ① ② ③ ④ ⑤ ⑥ ⑦ ⑧ ⑨ U side

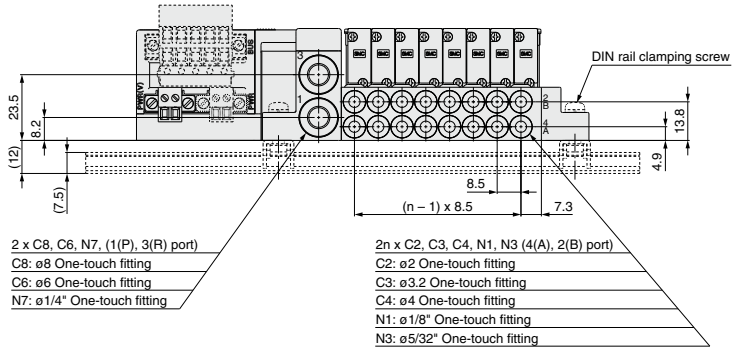

2 x C8, C6, N7, (1(P), 3(R) port)
 C8: ø8 One-touch fitting
 C6: ø6 One-touch fitting
 N7: ø1/4" One-touch fitting

2n x C2, C3, C4, N1, N3 (4(A), 2(B) port)
 C2: ø2 One-touch fitting
 C3: ø3.2 One-touch fitting
 C4: ø4 One-touch fitting
 N1: ø1/8" One-touch fitting
 N3: ø5/32" One-touch fitting

*: Dotted line indicates DIN rail mounting bracket (-D).

Dimensions

Formula $L1 = 8.5n + 38$, $L2 = 8.5n + 93.7$ n: Station (Maximum 32 stations)

L \ n	2	3	4	5	6	7	8	9	10	11	12	13	14	15	16	17	18
L1	55	63.5	72	80.5	89	97.5	106	114.5	123	131.5	140	148.5	157	165.5	174	182.5	191
L2	110.7	119.2	127.7	136.2	144.7	153.2	161.7	170.2	178.7	187.2	195.7	204.2	212.7	221.2	229.7	238.2	246.7
L3	137.5	150	150	162.5	175	175	187.5	200	200	212.5	225	225	237.5	250	250	262.5	275
L4	148	160.5	160.5	173	185.5	185.5	198	210.5	210.5	223	235.5	235.5	248	260.5	260.5	273	285.5

L \ n	19	20	21	22	23	24	25	26	27	28	29	30	31	32
L1	199.5	208	216.5	225	233.5	242	250.5	259	267.5	276	284.5	293	301.5	310
L2	255.2	263.7	272.2	280.7	289.2	297.7	306.2	314.7	323.2	331.7	340.2	348.7	357.2	365.7
L3	275	287.5	300	312.5	312.5	325	337.5	337.5	350	362.5	362.5	375	387.5	387.5
L4	285.5	298	310.5	323	323	335.5	348	348	360.5	373	373	385.5	398	398

Directional Control Valves

Air Cylinders

Rotary Actuators

Air Grippers

Air Preparation Equipment

Modular F. R.

Pressure Control Equipment

Fittings & Tubing

Flow Control Equipment

Pressure Switches/ Pressure Sensors

Plug-in Type Stacking Base
Serial Transmission
S kit

Plug-in Type
Stacking Base



For Output
Serial Transmission System
EX260

Page 423-6



Directional
Control Valves

Air Cylinders

Rotary Actuators

Air Grippers

Air Preparation
Equipment

Modular F. R.

Pressure Control
Equipment

Fittings & Tubing

Flow Control
Equipment

Pressure Switches/
Pressure Sensors

Plug-in Type



10-S0700 Series Stacking Base

Kit (Serial Transmission) EX260 (For Output) Serial Transmission System

How to Order Manifold

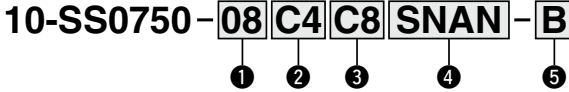
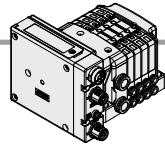

① Stations

In the case of the 32-output SI unit

Symbol	Stations	Note
01	1 station	Double wiring*1
:	:	
:	:	
16	16 stations	Specified layout*2 (Available up to 32 solenoids)
01	1 station	
:	:	
24	24 stations	

In the case of the 16-output SI unit

Symbol	Stations	Note
01	1 station	Double wiring*1
:	:	
:	:	
08	8 stations	Specified layout*2 (Available up to 16 solenoids)
01	1 station	
:	:	
16	16 stations	

- *1: Double wiring : single, double, 3-position and 4-position solenoid valves can be used on all manifold stations.
Up to 24 stations due to the structure of the manifold. Please note the maximum number of stations is 24 for single wiring, too.
- *2: Specified layout: Indicate the wiring specifications with the manifold specification sheet.
(Note that double, 3-position and 4-position valves cannot be used where single solenoid wiring has been specified.)
- *3: This also includes the number of blanking plate assembly.

② Cylinder port size

Symbol	Port size	
C2	With ø2 One-touch fitting	Metric
C3	With ø3.2 One-touch fitting	
C4	With ø4 One-touch fitting	
CM	Mixed sizes and with port plug*1	Inch
N1	With ø1/8" One-touch fitting	
N3	With ø5/32" One-touch fitting	
NM	Mixed sizes and with port plug*1	

- *1: Specify Mixed sizes and with port plug on the manifold specification sheet.

③ P, R port size

Symbol	Port size	
C6	With ø6 One-touch fitting	Metric
C8	With ø8 One-touch fitting	
N7	With ø1/4" One-touch fitting	Inch
N9	With ø5/16" One-touch fitting	

- *: If an inch size cylinder port is selected, select inch size piping connections for the P and R ports as well.

④ SI unit specifications

(Output polarity, protocol, number of outputs, communication connector)

Symbol (output polarity)		Protocol	Number of outputs	Communication connector
Positive common (NPN)	Negative common (NPN)			
SD0*1				
Without SI unit				
SQA	SQAN	DeviceNet®	32	M12
SQB	SQAN		16	
SNA	SNAN	PROFIBUS DP	32	M12
SNB	SNBN		16	
SNC	SNCN	CC-Link	32	M12
SND	SNDN		16	
SVA	SVAN	EtherCAT	32	M12
SVB	SVBN		16	
SDA	SDAN	PROFINET	32	M12
SDB	SDBN		16	
SFA	SFAN	EtherNet/IP™	32	M12
SFB	SFBN		16	
SEA	SEAN	Ethernet	32	M12
SEB	SEBN		16	
—*3	SGAN	POWERLINK	32	
—*3	SGBN	POWERLINK	16	

- *1: Without SI Unit, the output polarity is decided by the SI unit used.
- *2: DIN rail cannot be mounted without SI unit.
- *3: Positive common (NPN) type is not applicable.
- *4: IP40 for the D-sub applicable communication connector specification.
- *5: The maximum number of stations is determined by the total number of solenoids.
For mixed single and double wirings, enter -K to the order code options.
- *6: For SI unit part number, refer to page 444.

⑤ Option

Symbol	Specifications
Nll	None
B*1	With back pressure check valve (All stations)
D	With DIN rail (Rail length: Standard)
D0	Without DIN rail (with bracket)
D□*2	With DIN rail Designated length (□: Station)
K*3	Special wiring specifications (Except double wiring)
N	With name plate
R*4	External pilot

- *1: When installing a back pressure check valve on the required station, enter the part number and specify the station position on the manifold specification sheet.
- *2: The available number of stations is larger than the number of manifold stations.
- *3: Indicate the wiring specifications for mixed single and double wirings.
- *4: For details, refer to page 481.
- *5: When two or more options are specified, indicate them alphabetically. Example) -BKN
- *6: For manifold optional parts, refer to pages 481 to 484.
- *7: When the SD0 (Without SI unit) is specified, -D, -D□ cannot be selected.

Refer to the **Web Catalog** and the Operation Manual for the details of the EX260 Integrated-type (For Output) Serial Transmission System. Please download the Operation Manual via our website, <http://www.smcworld.com>

How to Order Valves

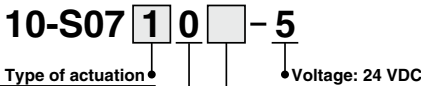

Symbol	Specifications
1	2-position single
2	2-position double
A	4-position dual 3-port (N.C. + N.C.) [Exhaust center]
B	4-position dual 3-port (N.O. + N.O.) [Pressure center]
C	4-position dual 3-port (N.C. + N.O.)

- *: For symbol, refer to page 423.

Function

Symbol	Specifications
Nll	Standard
R	External pilot*1

- *1: Not compatible with dual 3-port valves.
The 3(R) port is open to the atmosphere. (Cannot be used for applying pressure or vacuum)

Base mounted plug-in



How to Order Manifold Assembly

Example Serial transmission kit

Specify the part numbers for valves and options together beneath the manifold base part number.

10-SS0750-04C4C8SNAN... 1 set - Manifold base part no.
 * 10-S0720-5 4 sets - Valve part no. (Stations 1 to 4)

Prefix the asterisk to the part numbers of the solenoid valve etc. Write sequentially from the 1st station on the D side. When part numbers written collectively are complicated, specify on the manifold specification sheet.

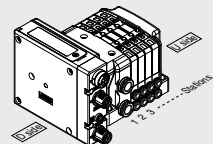

Plug-in Type **Stacking Base**
EX260 (For Output) Serial Transmission System **10-S0700 Series**

10-SS0750
S kit (Serial transmission: EX260)

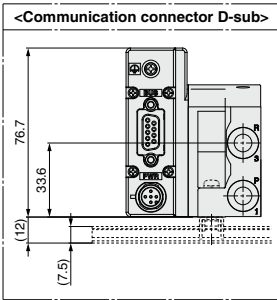
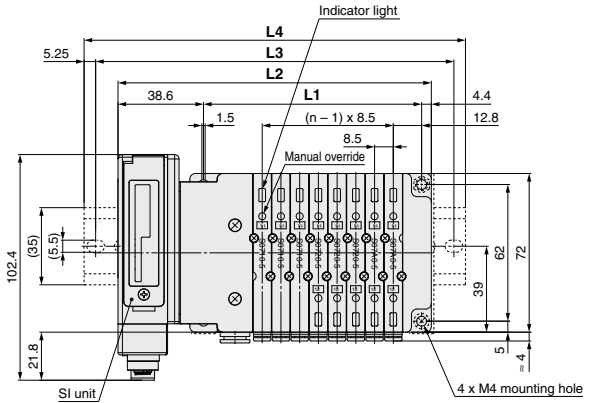
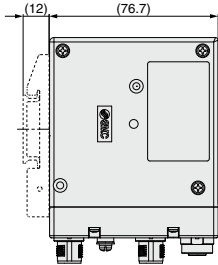

D side Stations ① ② ③ ④ ⑤ ⑥ ⑦ ⑧ U side

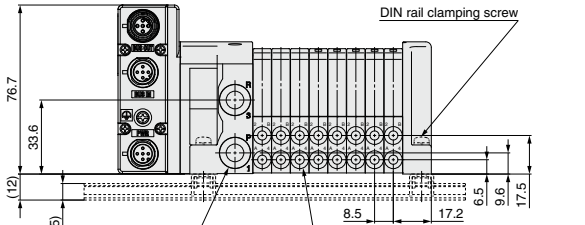

- 2 x C6, C8, N7, N9 (1(P), 3(R) port)
- C6: ø6 One-touch fitting
- C8: ø8 One-touch fitting
- N7: ø1/4" One-touch fitting
- N9: ø5/16" One-touch fitting

- 2n x C2, C3, C4, N1, N3 (4(A), 2(B) port)
- C2: ø2 One-touch fitting
- C3: ø3.2 One-touch fitting
- C4: ø4 One-touch fitting
- N1: ø1/8" One-touch fitting
- N3: ø5/32" One-touch fitting

Dimensions

Formula L1 = 8.5n + 31, L2 = 8.5n + 74 n: Station (Maximum 24 stations)

L \ n	1	2	3	4	5	6	7	8	9	10	11	12	13	14	15	16
L1	39.5	48	56.5	65	73.5	82	90.5	99	107.5	116	124.5	133	141.5	150	158.5	167
L2	82.5	91	99.5	108	116.5	125	133.5	142	150.5	159	167.5	176	184.5	193	201.5	210
L3	112.5	112.5	125	137.5	137.5	150	162.5	162.5	175	187.5	187.5	200	212.5	212.5	225	237.5
L4	123	123	135.5	148	148	160.5	173	173	185.5	198	198	210.5	223	223	235.5	248

L \ n	17	18	19	20	21	22	23	24
L1	175.5	184	192.5	201	209.5	218	226.5	235
L2	218.5	227	235.5	244	252.5	261	269.5	278
L3	250	250	262.5	275	275	287.5	300	300
L4	260.5	260.5	273	285.5	285.5	298	310.5	310.5

Directional Control Valves
 Air Cylinders
 Rotary Actuators
 Air Grippers
 Air Preparation Equipment
 Modular F. R.
 Pressure Control Equipment
 Fittings & Tubing
 Flow Control Equipment
 Pressure Switches/ Pressure Sensors

Slim Compact Plug-in Manifold Bar Base

Serial Transmission

S kit

Slim Compact
Plug-in Manifold
Bar Base

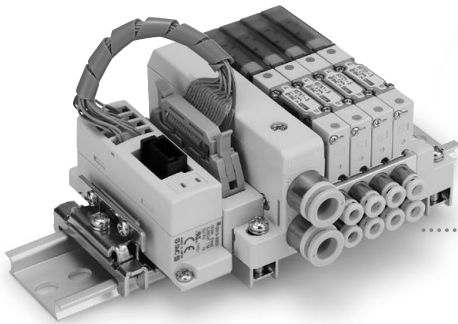

Gateway-type
Serial Transmission
System
EX510



Page 425

Directional
Control Valves

Air Cylinders

Rotary Actuators

Air Grippers

Air Preparation
Equipment

Modular F. R.

Pressure Control
Equipment

Fittings & Tubing

Flow Control
Equipment

Pressure Switches/
Pressure Sensors



Series 10-S0700 Slim Compact Plug-in Manifold Bar Base kit (Serial Transmission) EX510 Gateway-type Serial Transmission System

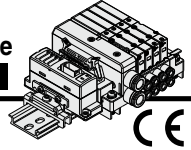

How to Order Manifold

10-SS0751-08 C4 C8 SB -

Clean series

Stations

Symbol	Stations
01	1 station
:	:
16 (Note)	16 stations

Note) The maximum number of stations will be different depending on the wiring specifications.

Cylinder port size

Symbol	Port size	
C2	With ø2 One-touch fitting	Metric
C3	With ø3.2 One-touch fitting	
C4	With ø4 One-touch fitting	
N1	With ø1/8" One-touch fitting	Inch
N3	With ø5/32" One-touch fitting	

Standard station	Max. number of stations for special wiring specifications	Max. number of solenoids
1 to 8 stations	16 stations	16

Actuation type	Single	Double, Dual 3-port
Number of solenoids	1	2

P, R port size

Symbol	Port size	
C6	With ø6 One-touch fitting	Metric
C8	With ø8 One-touch fitting	
N7	With ø1/4" One-touch fitting	Inch
N9	With ø5/16" One-touch fitting	

Note) If an inch size cylinder port is selected, select inch size piping connections for the P and R ports as well.

Option

Symbol	Specifications
Nil	None
K (Note 2)	Special wiring specifications (Except double wiring)
R (Note 3)	External pilot

Note 1) When two or more options are specified, indicate them alphabetically.

Example) -KR

Note 2) Indicate the wiring specifications for mixed single and double wirings.

Note 3) For details, refer to page 441.

* For manifold optional parts, refer to pages 440 and 441.

* For manifold exploded view, refer to page 443.

SI unit output polarity

SI unit output polarity	
Nil	+COM.
N	-COM.

S kit

EX510 serial wiring

Refer to the **WEB catalog** for details on the EX510 Gateway-type Serial Transmission System.

How to Order Valve

10-S07 1 1 - 5

Clean series

Actuation type

Symbol	Specifications
1	2-position single
2	2-position double
A	4-position dual 3-port (N.C. + N.C.) [Exhaust center]
B	4-position dual 3-port (N.O. + N.O.) [Pressure center]
C	4-position dual 3-port (N.C. + N.O.)

Note) For symbol, refer to page 423.

Voltage: 24 VDC

Function

Symbol	Specifications
Nil	Standard
R	External pilot (Note)

Note) Not compatible with dual 3-port valves. The 3(R) port is released to the atmosphere. (Pressurization and vacuum are not allowed.)

Base mounted plug-in

How to Order Manifold Assembly

Specify the part numbers for valves and options together beneath the manifold base part number.

<Example>

Serial transmission kit

10-SS0751-08C4C8SB...1 set - Manifold base part no.

* 10-S0711-5 3 sets - Valve part no. (Stations 1 to 3)

* 10-S0721-5 2 sets - Valve part no. (Stations 4 to 5)

* 10-S07A1-5 2 sets - Valve part no. (Stations 6 to 7)

* SS0700-10A-3 1 set - Blanking plate part no. (Station 8)

Write sequentially from the 1st station on the D side. When part no. written collectively are complicated, specify on the manifold specification sheet.

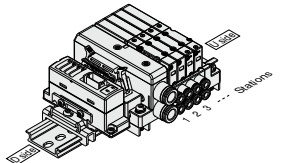

10-SS0751
S kit (Serial transmission: EX510)

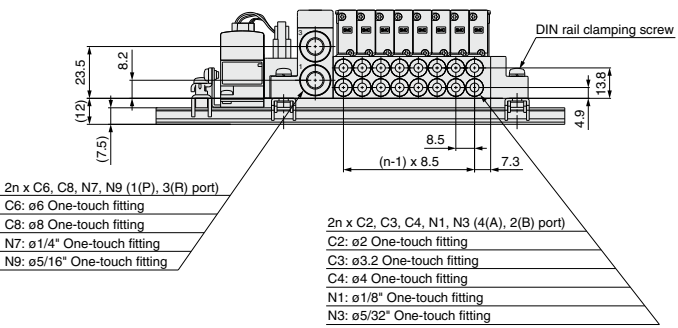
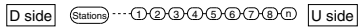
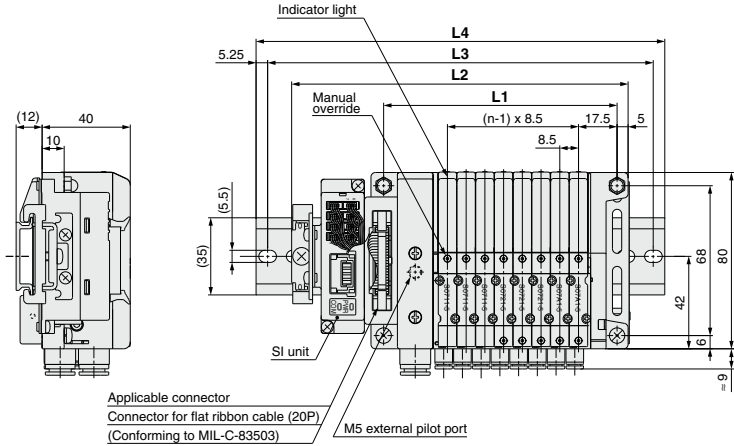

Dimensions

Formula L1 = 8.5n + 38, L2 = 8.5n + 84.7 n: Station (Maximum 16 stations)

L \ n	2	3	4	5	6	7	8	9	10	11	12	13	14	15	16
L1	55	63.5	72	80.5	89	97.5	106	114.5	123	131.5	140	148.5	157	165.5	174
L2	101.7	110.2	118.7	127.2	135.7	144.2	152.7	161.2	169.7	178.2	186.7	195.2	203.7	212.2	220.7
L3	125	137.5	150	162.5	175	187.5	197.5	207.5	217.5	227.5	237.5	247.5	257.5	267.5	277.5
L4	135.5	148	160.5	173	185.5	198	210.5	223	235.5	248	260.5	273	285.5	298	310.5

Directional Control Valves
 Air Cylinders
 Rotary Actuators
 Air Grippers
 Air Preparation Equipment
 Modular F. R.
 Pressure Control Equipment
 Fittings & Tubing
 Flow Control Equipment
 Pressure Switches/ Pressure Sensors

Slim Compact Plug-in Manifold Bar Base

D-sub Connector

F kit

Slim Compact
Plug-in Manifold
Bar Base

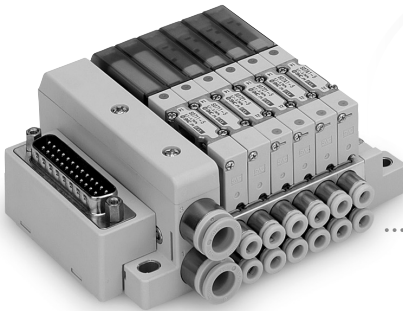

MIL Standard

- 25 pins
- Cable length:
1.5 m, 3 m, 5 m

Page 429



Directional
Control Valves

Air Cylinders

Rotary Actuators

Air Grippers

Air Preparation
Equipment

Modular F. R.

Pressure Control
Equipment

Fittings & Tubing

Flow Control
Equipment

Pressure Switches/
Pressure Sensors

F

Series 10-S0700 Slim Compact Plug-in Manifold Bar Base kit (D-sub Connector)

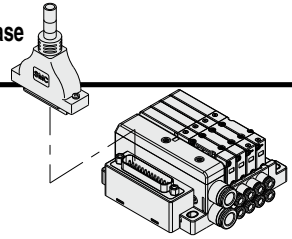

- The D-sub connector reduces installation labor for electrical connections.
- Using the D-sub connector (25P) conforming to MIL standard permits the use of commercial connectors and gives a wide interchangeability.

Electrical Wiring Specifications

D-sub connector

As the standard electrical wiring specifications, double wiring (connected to SOL.A and SOL.B) is adopted for the internal wiring of each station for 12 stations or less, regardless of valve and option types. Mixed single and double wiring is available as an option. For details, refer to "Special Wiring Specifications" (Option) below.

D-sub connector assembly wire color (AXT100-DS25-015 to 050)

Terminal no.	Polarity	Lead wire color	Dot marking	
Station 1 SOL.A 1	(-)	(+)	Black	None
Station 1 SOL.B 14	(-)	(+)	Yellow	Black
Station 2 SOL.A 2	(-)	(+)	Brown	None
Station 2 SOL.B 15	(-)	(+)	Pink	Black
Station 3 SOL.A 3	(-)	(+)	Red	None
Station 3 SOL.B 16	(-)	(+)	Blue	White
Station 4 SOL.A 4	(-)	(+)	Orange	None
Station 4 SOL.B 17	(-)	(+)	Purple	None
Station 5 SOL.A 5	(-)	(+)	Yellow	None
Station 5 SOL.B 18	(-)	(+)	Gray	None
Station 6 SOL.A 6	(-)	(+)	Pink	None
Station 6 SOL.B 19	(-)	(+)	Orange	Black
Station 7 SOL.A 7	(-)	(+)	Blue	None
Station 7 SOL.B 20	(-)	(+)	Red	White
Station 8 SOL.A 8	(-)	(+)	Purple	White
Station 8 SOL.B 21	(-)	(+)	Brown	White
Station 9 SOL.A 9	(-)	(+)	Gray	Black
Station 9 SOL.B 22	(-)	(+)	Pink	Red
Station 10 SOL.A 10	(-)	(+)	White	Black
Station 10 SOL.B 23	(-)	(+)	Gray	Red
Station 11 SOL.A 11	(-)	(+)	White	Red
Station 11 SOL.B 24	(-)	(+)	Black	White
Station 12 SOL.A 12	(-)	(+)	Yellow	Red
Station 12 SOL.B 25	(-)	(+)	White	None
COM. 13	(+)	(-)	Orange	Red

Note) Mounting valve has no polarity. It can also be used as a negative common.

Special Wiring Specifications (Option) [-K]

Mixed single and double wiring are available as an option. The maximum number of manifold stations is determined by the number of solenoids. Count one point for a single solenoid type and two points for a double solenoid type. The total number of solenoids (points) must not exceed 24.

1. How to Order valve
Indicate an option symbol, -K, for the manifold part number and be sure to specify the mounting position and number of stations of the single and double wiring on the manifold specification sheet.

2. Wiring specifications
Connector terminal numbers are connected from solenoid station 1 on the A side in the order indicated by the arrows without skipping any terminal numbers.

Cable Assembly

AXT100-DS25-030
015
050

(The D-sub connector cable assemblies can be ordered with manifolds.)
Refer to "How to Order Manifold."

D-sub connector cable assembly Wire Color by Terminal No.

Terminal no.	Lead wire color	Dot marking
1	Black	None
2	Brown	None
3	Red	None
4	Orange	None
5	Yellow	None
6	Pink	None
7	Blue	None
8	Purple	White
9	Gray	Black
10	White	Black
11	White	Red
12	Yellow	Red
13	Orange	Red
14	Yellow	Black
15	Pink	Black
16	Blue	White
17	Purple	None
18	Gray	None
19	Orange	Black
20	Red	White
21	Brown	White
22	Pink	Red
23	Gray	Red
24	Black	White
25	White	None

D-sub Connector Cable Assembly (Option)

Cable length (L)	Assembly part no.	Note
1.5 m	AXT100-DS25-015	
3 m	AXT100-DS25-030	Cable 0.3 mm ² x 25 cores
5 m	AXT100-DS25-050	

* For other commercial connectors, use a 25-pin type with female connector conforming to MIL-C-24308.
* Cannot be used for movable wiring.

Example of connector manufacturers

- Fujitsu Limited
- Japan Aviation Electronics Industry, Limited
- J.S.T. Mfg. Co., Ltd.
- HIROSE ELECTRIC CO., LTD.

Note) The minimum bending radius of D-sub connector cable is 20 mm.





How to Order Manifold

10-SS0751-08 C4 C8 FD1- □

Clean series

Stations

Symbol	Stations
01	1 station
⋮	⋮
24 ^(Note)	24 stations

(Note) The maximum number of stations will be different depending on the wiring specifications.

Cylinder port size

Symbol	Port size	
C2	With ø2 One-touch fitting	Metric
C3	With ø3.2 One-touch fitting	
C4	With ø4 One-touch fitting	
N1	With ø1/8" One-touch fitting	Inch
N3	With ø5/32" One-touch fitting	

P, R port size

Symbol	Port size	
C6	With ø6 One-touch fitting	Metric
C8	With ø8 One-touch fitting	
N7	With ø1/4" One-touch fitting	
N9	With ø5/16" One-touch fitting	Inch

(Note) If an inch size cylinder port is selected, select inch size piping connections for the P and R ports as well.

Option

Symbol	Specifications
Nil	None
D	With DIN rail (Rail length: Standard)
D0	Without DIN rail (With bracket)
D□ ^(Note 2)	With DIN rail Designated length (□: Station)
K ^(Note 3)	Special wiring specifications (Except double wiring)
R ^(Note 4)	External pilot

(Note 1) When two or more options are specified, indicate them alphabetically. Example) -DKR
 (Note 2) The available number of stations is larger than the number of manifold stations.

(Note 3) Indicate the wiring specifications for mixed single and double wirings.

(Note 4) For details, refer to page 441.

* For manifold optional parts, refer to pages 440 to 441.

* For manifold exploded view, refer to page 443.

Kit type/Cable length

Kit type	Symbol	Specifications	Standard station	Max. number of stations for special wiring specifications	Max. number of solenoids
F kit	FD0	D-sub connector (25P), without cable	1 to 12 stations	24 stations	24
	FD1	D-sub connector (25P), with 1.5 m cable			
	FD2	D-sub connector (25P), with 3.0 m cable			
	FD3	D-sub connector (25P), with 5.0 m cable			

(Note) The maximum number of stations is determined by the total number of solenoids.
 For mixed single and double wirings, enter "K" to the order code options.

Actuation type	Single	Double, Dual 3-port
Number of solenoids	1	2

How to Order Valve

10-S07 1 1 □ **-5**

Clean series

Actuation type

Symbol	Specifications
1	2-position single
2	2-position double
A	4-position dual 3-port (N.C. + N.C.) [Exhaust center]
B	4-position dual 3-port (N.O. + N.O.) [Pressure center]
C	4-position dual 3-port (N.C. + N.O.)

(Note) For symbol, refer to page 423.

Base mounted plug-in

Voltage

Symbol	Specifications
5	24 VDC
6	12 VDC

Function

Symbol	Specifications
Nil	Standard
R	External pilot ^(Note)

(Note) Not compatible with dual 3-port valves.
 The 3(R) port is released to the atmosphere. (Pressurization and vacuum are not allowed.)

How to Order Manifold Assembly

Specify the part numbers for valves and options together beneath the manifold base part number.

<Example>

D-sub connector kit
 10-SS0751-08C4C8FD1...1 set - Manifold base part no.
 = 10-S0711-5.....3 sets - Valve part no. (Stations 1 to 3)
 = 10-S0721-5.....2 sets - Valve part no. (Stations 4 to 5)
 = 10-S07A1-5.....2 sets - Valve part no. (Stations 6 to 7)
 = SS0700-10A-3.....1 set - Blanking plate part no. (Station 8)

Write sequentially from the 1st station on the D side. When part no. written collectively are complicated, specify on the manifold specification sheet.

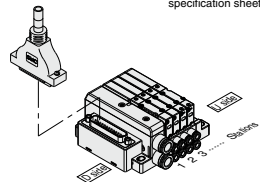

Directional Control Valves

Air Cylinders

Rotary Actuators

Air Grippers

Air Preparation Equipment

Modular F. R.

Pressure Control Equipment

Fittings & Tubing

Flow Control Equipment

Pressure Switches/Pressure Sensors

F

Series 10-S0700 kit (D-sub Connector)

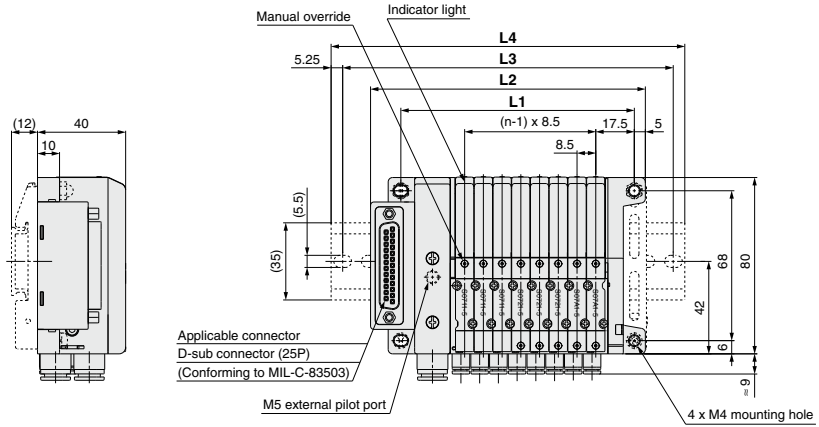

D side Stations ① ② ③ ④ ⑤ ⑥ ⑦ ⑧ n U side

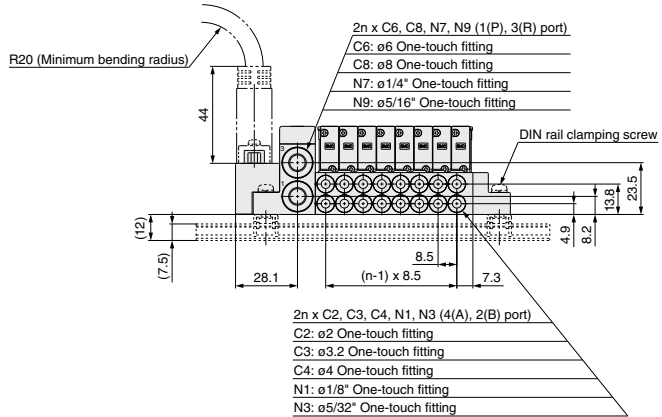

Dimensions

Formula L1 = 8.5n + 38, L2 = 8.5n + 56.7 n: Station (Maximum 24 stations)

L \ n	2	3	4	5	6	7	8	9	10	11	12	13	14	15	16	17	18	19	20	21	22	23	24
L1	55	63.5	72	80.5	89	97.5	106	114.5	123	131.5	140	148.5	157	165.5	174	182.5	191	199.5	208	216.5	225	233.5	242
L2	73.7	82.2	90.7	99.2	107.7	116.2	124.7	133.2	141.7	150.2	158.7	167.2	175.7	184.2	192.7	201.2	209.7	218.2	226.7	235.2	243.7	252.2	260.7
L3	100	112.5	112.5	125	137.5	137.5	150	162.5	162.5	175	187.5	187.5	200	212.5	212.5	225	237.5	237.5	250	262.5	275	275	287.5
L4	110.5	123	123	135.5	148	148	160.5	173	173	185.5	198	198	210.5	223	223	235.5	248	248	260.5	273	285.5	285.5	298

Slim Compact Plug-in Manifold Bar Base

Flat Ribbon Cable

P kit

Slim Compact
Plug-in Manifold
Bar Base

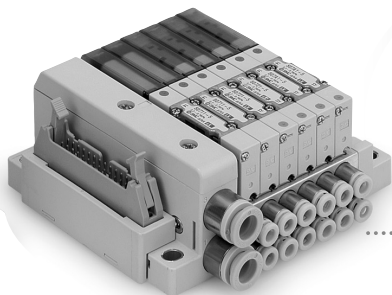

MIL Standard

- 26 pins, 20 pins
- Cable length:
1.5 m, 3 m, 5 m

Page 433



Directional
Control Valves

Air Cylinders

Rotary Actuators

Air Grippers

Air Preparation
Equipment

Modular F. R.

Pressure Control
Equipment

Fittings & Tubing

Flow Control
Equipment

Pressure Switches/
Pressure Sensors

P Series 10-S0700 Slim Compact Plug-in Manifold Bar Base kit (Flat Ribbon Cable)

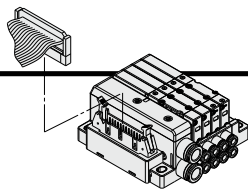

- Flat ribbon cable connector reduces installation labor for electrical connection.
- Using the connector for flat ribbon cable (26P, 20P) conforming to MIL standard permits the use of commercial connectors and gives a wide interchangeability.

Electrical Wiring Specifications

Flat ribbon cable connector

Double wiring (connected to SOL.A and SOL.B) is adopted for the internal wiring of each station, regardless of valve and option types. Mixed single and double wiring is available as an option. For details, refer to "Special Wiring Specifications" (Option) below.

Connector terminal no.
Triangle mark indicator position

26 □	□ 25
24 □	□ 23
22 □	□ 21
20 □	□ 19
18 □	□ 17
16 □	□ 15
14 □	□ 13
12 □	□ 11
10 □	□ 9
8 □	□ 7
6 □	□ 5
4 □	□ 3
2 □	□ 1

<26P>

Terminal no.	Polarity
SOL.A ₁	(-)
SOL.B ₂	(+)
SOL.A ₃	(-)
SOL.B ₄	(+)
SOL.A ₅	(-)
SOL.B ₆	(+)
SOL.A ₇	(-)
SOL.B ₈	(+)
SOL.A ₉	(-)
SOL.B ₁₀	(+)
SOL.A ₁₁	(-)
SOL.B ₁₂	(+)
SOL.A ₁₃	(-)
SOL.B ₁₄	(+)
SOL.A ₁₅	(-)
SOL.B ₁₆	(+)
SOL.A ₁₇	(-)
SOL.B ₁₈	(+)
SOL.A ₁₉	(-)
SOL.B ₂₀	(+)
SOL.A ₂₁	(-)
SOL.B ₂₂	(+)
SOL.A ₂₃	(-)
SOL.B ₂₄	(+)
COM. ₂₅	(+)
COM. ₂₆	(+)

Positive COM Negative COM (Note)

<20P>

Terminal no.	Polarity
SOL.A ₁	(-)
SOL.B ₂	(+)
SOL.A ₃	(-)
SOL.B ₄	(+)
SOL.A ₅	(-)
SOL.B ₆	(+)
SOL.A ₇	(-)
SOL.B ₈	(+)
SOL.A ₉	(-)
SOL.B ₁₀	(+)
SOL.A ₁₁	(-)
SOL.B ₁₂	(+)
SOL.A ₁₃	(-)
SOL.B ₁₄	(+)
SOL.A ₁₅	(-)
SOL.B ₁₆	(+)
SOL.A ₁₇	(-)
SOL.B ₁₈	(+)
COM. ₁₉	(+)
COM. ₂₀	(+)

Positive COM Negative COM

Note) Mounting valve has no polarity. It can also be used as a negative common.

Cable Assembly

AXT100-FC²⁰₂₆¹₋₂³

(Type 26P flat ribbon cable connector assemblies can be ordered with manifolds. Refer to "How to Order Manifold.")

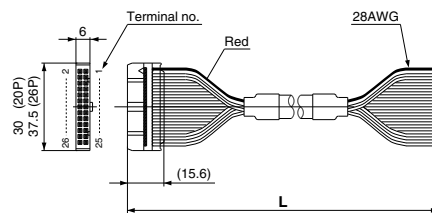

Flat Ribbon Cable Connector Assembly (Option)

Cable length (L)	Assembly part no.	
	26P	20P
1.5 m	AXT100-FC26-1	AXT100-FC20-1
3 m	AXT100-FC26-2	AXT100-FC20-2
5 m	AXT100-FC26-3	AXT100-FC20-3

- * For other commercial connectors, use a 20- or 26-pin type with strain relief conforming to MIL-C-83503.
- * Cannot be used for movable wiring.

Example of connector manufacturers

- HIROSE ELECTRIC CO., LTD.
- 3M Japan Limited
- Fujitsu Limited
- Japan Aviation Electronics Industry, Limited
- J.S.T. Mfg. Co., Ltd.
- Oki Electric Cable Co., Ltd.

Special Wiring Specifications (Option) [-K]

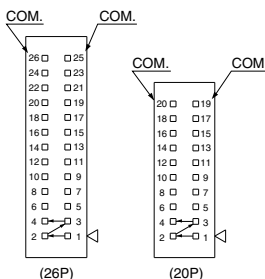

Mixed single and double wiring are available as an option. The maximum number of manifold stations is determined by the number of solenoids. Count one point for a single solenoid type and two points for a double solenoid type. The total number of solenoids (points) must not exceed 24 for 26P, 18 for 20P.

- How to Order valve**
Indicate an option symbol, -K, for the manifold part number and be sure to specify the mounting position and number of stations on the manifold specification sheet.
- Wiring specifications**
Connector terminal numbers are connected from solenoid station 1 on the A side in the order indicated by the arrows without skipping any terminal numbers.



How to Order Manifold

10-SS0751-08 C4 C8 PD1-

Clean series

Stations

Symbol	Stations
01	1 station
⋮	⋮
24	24 stations

Note) The maximum number of stations will be different depending on the wiring specifications.

Cylinder port size

Symbol	Port size	
C2	With ø2 One-touch fitting	Metric
C3	With ø3.2 One-touch fitting	
C4	With ø4 One-touch fitting	
N1	With ø1/8" One-touch fitting	Inch
N3	With ø5/32" One-touch fitting	

P, R port size

Symbol	Port size	
C6	With ø6 One-touch fitting	Metric
C8	With ø8 One-touch fitting	
N7	With ø1/4" One-touch fitting	
N9	With ø5/16" One-touch fitting	Inch

Note) If an inch size cylinder port is selected, select inch size piping connections for the P and R ports as well.

Option

Symbol	Specifications
Nil	None
D	With DIN rail (Rail length: Standard)
D0	Without DIN rail (With bracket)
D□ ^{Note 2)}	With DIN rail Designated length (□: Station)
K ^{Note 3)}	Special wiring specifications (Except double wiring)
R ^{Note 4)}	External pilot

- Note 1) When two or more options are specified, indicate them alphabetically. Example) -DKR
- Note 2) The available number of stations is larger than the number of manifold stations.
- Note 3) Indicate the wiring specifications for mixed single and double wirings.
- Note 4) For details, refer to page 441.
- * For manifold optional parts, refer to pages 440 to 441.
- * For manifold exploded view, refer to page 443.

Kit type/Cable length

Kit type	Symbol	Specifications	Standard station	Max. number of stations for special wiring specifications	Max. number of solenoids
P kit	PD0	Flat ribbon cable (26P), without cable	1 to 12 stations	24 stations	24
	PD1	Flat ribbon cable (26P), with 1.5 m cable			
	PD2	Flat ribbon cable (26P), with 3.0 m cable			
	PD3	Flat ribbon cable (26P), with 5.0 m cable			
	PDC	Flat ribbon cable (20P), without cable			

Note) The maximum number of stations is determined by the total number of solenoids. For mixed single and double wirings, enter "K" to the order code options.

Actuation type	Single	Double, Dual 3-port
Number of solenoids	1	2

How to Order Valve

10-S07 1 1 **-5**

Clean series

Actuation type

Symbol	Specifications
1	2-position single
2	2-position double
A	4-position dual 3-port (N.C. + N.C.) [Exhaust center]
B	4-position dual 3-port (N.O. + N.O.) [Pressure center]
C	4-position dual 3-port (N.C. + N.O.)

Note) For symbol, refer to page 423.

Base mounted plug-in

Voltage

Symbol	Specifications
5	24 VDC
6	12 VDC

Function

Symbol	Specifications
Nil	Standard
R	External pilot ^{Note)}

Note) Not compatible with dual 3-port valves. The 3(R) port is released to the atmosphere. (Pressurization and vacuum are not allowed.)

How to Order Manifold Assembly

Specify the part numbers for valves and options together beneath the manifold base part number.

<Example>

Flat ribbon cable kit

- 10-SS0751-08C4C8PD1... 1 set - Manifold base part no.
- * 10-S0711-5 2 sets - Valve part no. (Stations 1 to 3)
- * 10-S0721-5 4 sets - Valve part no. (Stations 4 to 5)
- * 10-S07A1-5 1 set - Valve part no. (Stations 6 to 7)
- * SS0700-10A-3 1 set - Blanking plate part no. (Station 8)

Prefix the asterisk to the part no. of the solenoid valve, etc.

Write sequentially from the 1st station on the D side. When part no. written collectively are complicated, specify on the manifold specification sheet.

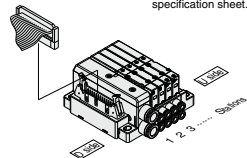

Directional Control Valves

Air Cylinders

Rotary Actuators

Air Grippers

Air Preparation Equipment

Modular F. R.

Pressure Control Equipment

Fittings & Tubing

Flow Control Equipment

Pressure Switches/ Pressure Sensors

P Series 10-S0700 kit (Flat Ribbon Cable)

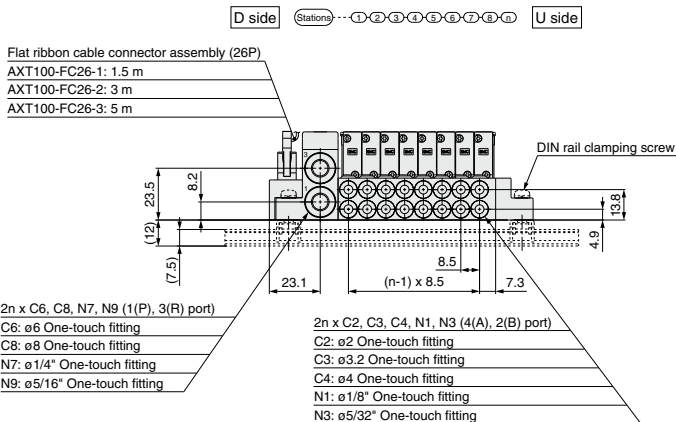
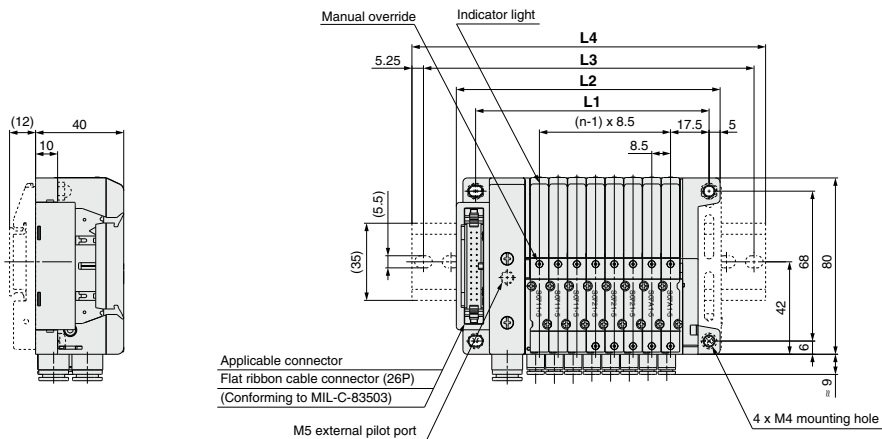

Dimensions

Formula L1 = 8.5n + 38, L2 = 8.5n + 51.7 n: Station (Maximum 24 stations)

L	n	2	3	4	5	6	7	8	9	10	11	12	13	14	15	16	17	18	19	20	21	22	23	24
L1	55	63.5	72	80.5	89	97.5	106	114.5	123	131.5	140	148.5	157	165.5	174	182.5	191	199.5	208	216.5	225	233.5	242	
L2	68.7	77.2	85.7	94.2	102.7	111.2	119.7	128.2	136.7	145.2	153.7	162.2	170.7	179.2	187.7	196.2	204.7	213.2	221.7	230.2	238.7	247.2	255.7	
L3	100	100	112.5	125	137.5	150	150	162.5	175	175	187.5	200	200	212.5	225	225	237.5	250	250	262.5	275	275	287.5	
L4	110.5	110.5	123	135.5	148	148	160.5	160.5	173	185.5	185.5	198	210.5	210.5	223	235.5	235.5	248	260.5	260.5	273	285.5	285.5	

Series 10-S0700 Slim Compact Plug-in Manifold Bar Base

Manifold Optional Parts

Blanking plate assembly

SS0700-10A-3

It is used by attaching on the manifold block for being prepared for removing a valve for maintenance reasons or planning to mount a spare valve, etc.

Weight: 8 g

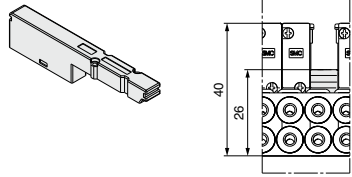

Individual SUP spacer

SS0700-P-3-C

Mounted on the manifold block to make an independent supply port when each solenoid valve uses different operating pressure.

Weight: 15 g

Port size

Symbol	Applicable tubing
C2	Applicable tubing ø2
C3	Applicable tubing ø3
C4	Applicable tubing ø4
N1	Applicable tubing ø1/8"
N3	Applicable tubing ø5/32"

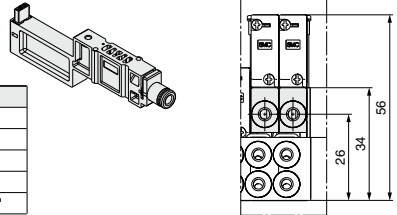

Individual EXH spacer

SS0700-R-3-C

Mounted on the manifold block to make an independent exhaust port when the exhaust from one valve affects valves on other stations in the air circuit.

Weight: 15 g

Port size

Symbol	Applicable tubing
C2	Applicable tubing ø2
C3	Applicable tubing ø3
C4	Applicable tubing ø4
N1	Applicable tubing ø1/8"
N3	Applicable tubing ø5/32"

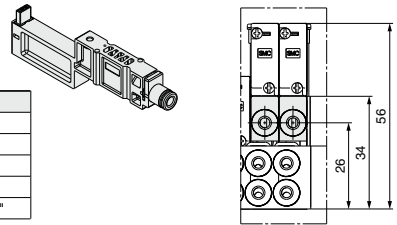

Blanking plate with output

SS0700-3C-

Lead wire length (mm)

Nil	600
10	1000
15	1500
20	2000
25	2500
30	3000

Blanking plate with a connector for individually outputting electricity to drive a single valve or equipment that are not on the manifold base.

Note 1) Electric current should be 0.5 A or less. (Including the mounted valves)
When the current is output from two positions at the same time, the current should be 0.25 A or less.

Note 2) Please consult with SMC for the max. allowable current for serial transmission kit.

Weight: 23 g



Blanking plate with output

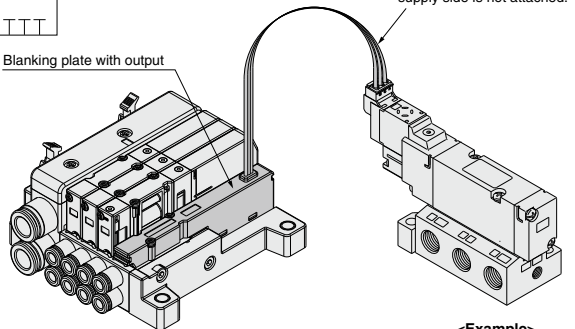

<Example>

Directional Control Valves

Air Cylinders

Rotary Actuators

Air Grippers

Air Preparation Equipment

Modular F. R.

Pressure Control Equipment

Fittings & Tubing

Flow Control Equipment

Pressure Switches/ Pressure Sensors

Series 10-S0700 Slim Compact Plug-in Manifold Bar Base

Manifold Optional Parts

External pilot [-R]

This can be used when the air pressure is 0.1 to 0.2 MPa lower than the minimum operating pressure of the solenoid valves or used for vacuum specifications.

Add R to the part numbers of manifolds and valves to indicate the external pilot specifications.

An M5 port will be installed on the top side of the manifold's SUP/EXH block.

● How to Order Valve (Example)

10-S0710 R -5

↓ External pilot

● How to Order Manifold (Example)

* Indicate R for an option.

10-SS0750-08C4FD1-R

↓ External pilot

External pilot port
(M5 x 0.8)

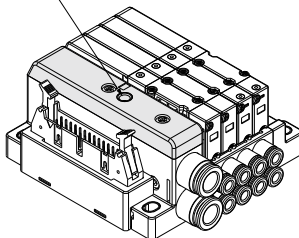

- Note 1) Not compatible with dual 3-port valves.
- Note 2) When the internal pilot type of valves are mixed up on the manifold, order the manifold suitable for the specifications of the external pilot valve.
- Note 3) Since the pilot EXH of valves with the external pilot specification also has a common exhaust specification, the 3(R) port should be released to the atmosphere.

DIN rail mounting bracket

SS0700-57A-3

It is used for mounting a manifold on a DIN rail. The DIN rail mounting bracket is fixed to the manifold end plate. (The specification is the same as that for the option "-D".)

1 set of DIN rail mounting bracket is included for 1 manifold (2 or 3 DIN rail mounting brackets (S, T kit)).

* When ordering this option incorporated with a manifold, suffix "-D" to the end of the manifold part number.

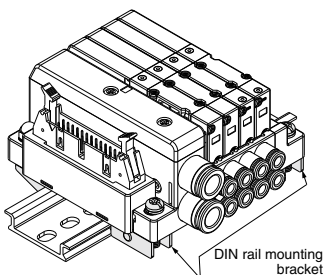

Series 10-S0700 Slim Compact Plug-in Manifold Bar Base Construction

Single: 10-S0711

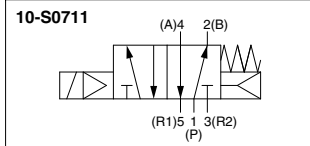
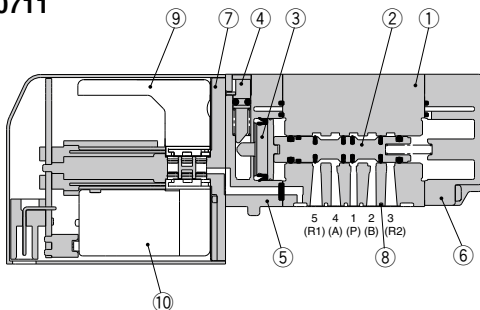

Double: 10-S0721

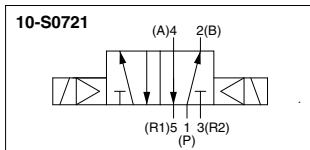
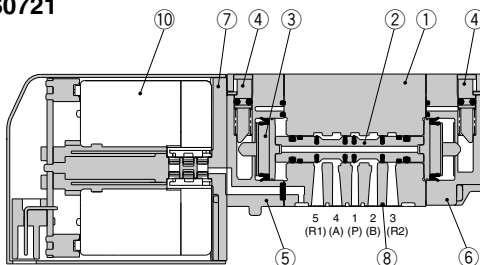

Dual 3-Port: 10-S07B1
A
C

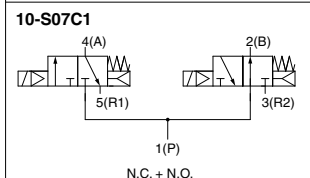
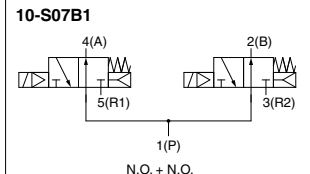
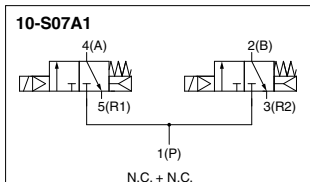
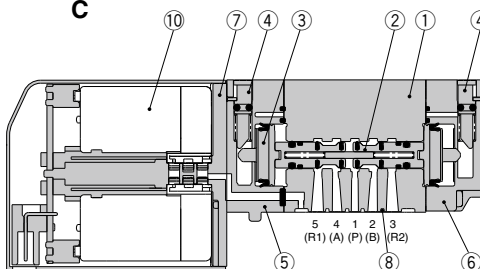

Component Parts

No.	Description	Material
1	Body	Zinc die-casted
2	Spool	Aluminum
3	Piston	Resin
4	Manual override	Resin
5	Adapter plate	Resin
6	End plate	Resin
7	Pilot spacer	Resin
8	Interface gasket	HNBR
9	Plate	Resin
10	Pilot valve assembly <small>(Note)</small>	—

Note) Please consult with SMC for pilot valve replacement.

Directional Control Valves
 Air Cylinders
 Rotary Actuators
 Air Grippers
 Air Preparation Equipment
 Modular F. R.
 Pressure Control Equipment
 Fittings & Tubing
 Flow Control Equipment
 Pressure Switches/ Pressure Sensors

Series 10-S0700 Slim Compact Plug-in Manifold Bar Base Manifold Exploded View

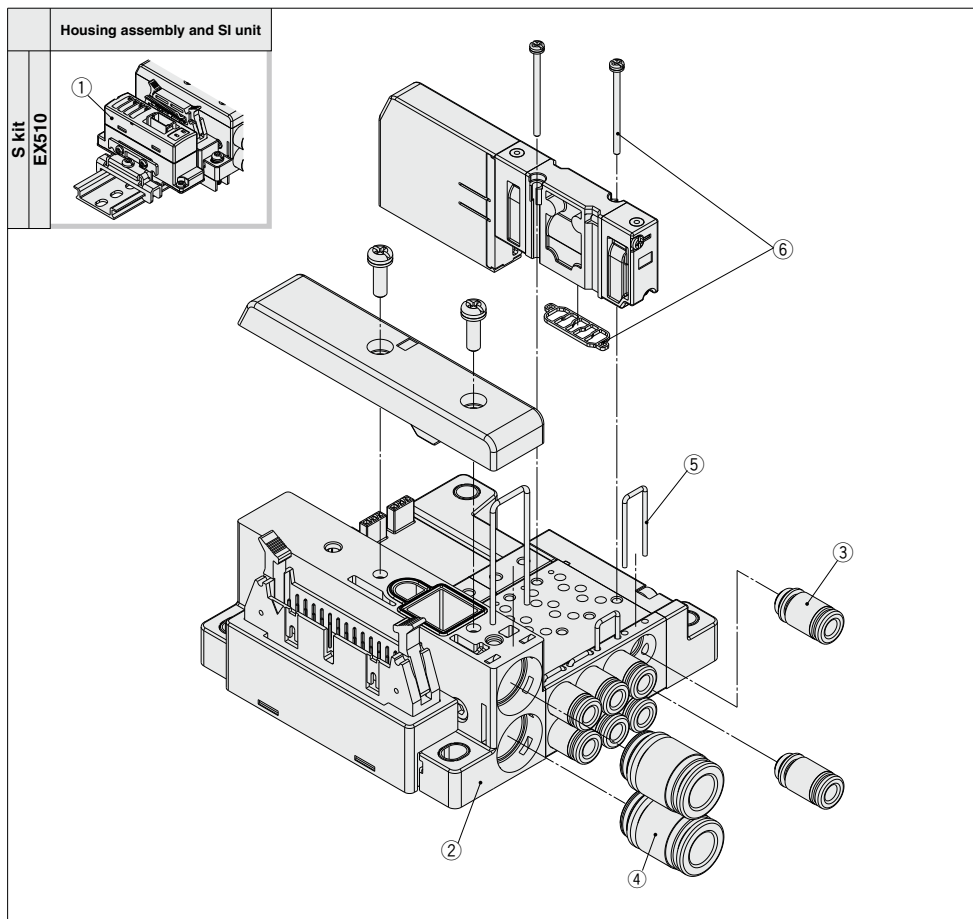

* It is not possible to increase or decrease the number of stations or change the wiring kit on the slim compact plug-in manifold bar base.
To change them, please change the entire base unit.

Manifold Assembly Part No.

No.	Description	Part no.	Note
①	SI unit	EX510-S002A	NPN (Positive common)
		EX510-S102A	PNP (Negative common)
②	Base unit	SS0751-□□□□	Refer to How to Order for each kit.

③ Fitting assembly part number for cylinder port**VVQ0000-50A-□**↓ **Port size**

Symbol	Applicable tubing
C2	Applicable tubing ø2
C3	Applicable tubing ø3
C4	Applicable tubing ø4
N1	Applicable tubing ø1/8"
N3	Applicable tubing ø5/32"

Note 1) Purchase orders are available in units of 10 pieces.

Note 2) For One-touch fittings replacement, refer to the Specific Product Precautions 2.

④ Fitting assembly part number for P, R port**VVQ1000-51A-□**↓ **Port size**

Symbol	Applicable tubing
C6	Applicable tubing ø6
C8	Applicable tubing ø8
N7	Applicable tubing ø1/4"
N9	Applicable tubing ø5/16"

Note 1) Purchase orders are available in units of 10 pieces.

Note 2) For One-touch fittings replacement, refer to the Specific Product Precautions 2.

No.	Description	Part no.
⑤	Clip	SS0700-80A-5

Note) 1 set includes 10 pieces.

No.	Description	Part no.
⑥	Gasket, Screw	SS0700-GS-3

Note) Above part number consists of 10 units. Each unit has one gasket and two screws.

Directional
Control Valves

Air Cylinders

Rotary Actuators

Air Grippers

Air Preparation
Equipment

Modular F. R.

Pressure Control
Equipment

Fittings & Tubing

Flow Control
EquipmentPressure Switches/
Pressure Sensors

Plug-in Manifold Stacking Base

Serial Transmission

S kit

Plug-in Manifold
Stacking Base



Gateway-type
Serial Transmission System

EX500

Page 447



Integrated-type (For I/O)
Serial Transmission System

EX250

Page 449



Integrated-type (For I/O)
Serial Transmission System (Fieldbus System)

EX600

Page 451



Directional
Control Valves

Air Cylinders

Rotary Actuators

Air Grippers

Air Preparation
Equipment

Modular F. R.

Pressure Control
Equipment

Fittings & Tubing

Flow Control
Equipment

Pressure Switches/
Pressure Sensors



Series 10-S0700 Plug-in Manifold Stacking Base kit (Serial Transmission) EX500 Gateway-type Serial Transmission System

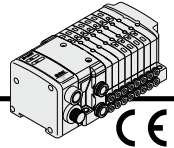

How to Order Manifold

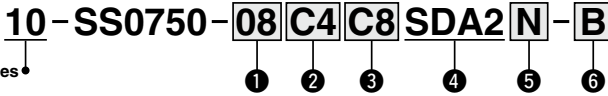

Clean series •

1 Valve stations

Stations	Note
01 1 station	Double wiring
⋮	
08 8 stations	
01 1 station	Specified layout*1 (Available up to 16 solenoids)
⋮	
16 16 stations	

*1: Specified layout: Indicate the wiring specifications on the manifold specification sheet. (Note that 2-position double, 3-position and 4-position valves cannot be used where single wiring has been specified.) In addition, select the option K.

2 A, B port size

Metric size

C2	ø2 One-touch fitting
C3	ø3.2 One-touch fitting
C4	ø4 One-touch fitting
CM*1	Mixed sizes and port plug

Inch size

N1	ø1/8" One-touch fitting
N3	ø5/32" One-touch fitting
NM*1	Mixed sizes and port plug

*1: Indicate the sizes on the manifold specification sheet.

3 P, R port size

Metric size

C6	ø6 One-touch fitting
C8	ø8 One-touch fitting

Inch size

N7	ø1/4" One-touch fitting
N9	ø5/16" One-touch fitting

*: If an inch size cylinder port is selected, select inch size piping connections for the P and R ports as well.

4 SI unit (Number of outputs, Max. number of valve stations)

SD0	Without SI unit
SDA2	16 outputs, 1 to 8 stations (16 stations)*1

*1: () : Maximum number of stations for mixed single and double wiring.
*: For SI unit part number, refer to page 444.

5 SI unit (Output polarity)

Nll	Positive common
N	Negative common

*: Ensure a match with the common specification of the valve to be used.
*: Select Nil for without SI unit.

6 Option

Nll	None
B*1	With back pressure check valve (All stations)
D	With DIN bracket, DIN rail with standard length
D0	With DIN bracket, without DIN rail
D□*2	With DIN bracket, DIN rail for □ stations
K□3	Special wiring specification (Except double wiring)
N	With name plate
R*4	External pilot

- *1: When a back pressure check valve is used only for specified station, specify the back pressure check valve part number, and specify the station number to which the valve is mounted, on the manifold specification sheet.
*2: □: Specify a longer rail than the length of valve stations.
Example) -D08
In this case, the valves will be mounted on the DIN rail for 8 stations, regardless of the number of manifold stations.
*3: When single wiring and double wiring are mixed, specify wiring type of each station on the manifold specification sheet.
*4: For external pilot option -R, indicate the external pilot specification R for the applicable valves as well.
*: When multiple symbols are specified, indicate them alphabetically. Example) -BKN
*: For manifold optional parts, refer to pages 481 to 484.
*: For manifold exploded view, refer to page 487.

How to Order Manifold Assembly

Specify the part numbers for valves and options together beneath the manifold base part number.

<Example>

Serial transmission kit

10-SS0750-08C4C8SDA2... 1 set - Manifold base part no.

- * 10-S0710-5 3 sets - Valve part no. (Stations 1 to 3)
- * 10-S0720-5 2 sets - Valve part no. (Stations 4 to 5)
- * 10-S07A0-5 2 sets - Valve part no. (Stations 6 to 7)
- * SS0700-10A-1 1 set - Blanking plate part no. (Station 8)

Prefix the asterisk to the part no. of the solenoid valve, etc.

Write sequentially from the 1st station on the D side. When part no. written collectively are complicated, specify on the manifold specification sheet.

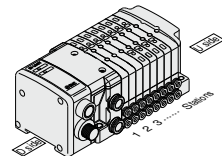

How to Order Valves

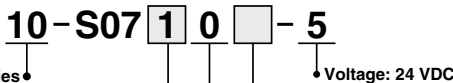

Symbol	Specifications
1	2-position single
2	2-position double
A	4-position dual 3-port (N.C. + N.C.) [Exhaust center]
B	4-position dual 3-port (N.O. + N.O.) [Pressure center]
C	4-position dual 3-port (N.C. + N.O.)

*: For symbol, refer to page 423.

Function

Symbol	Specifications
Nll	Standard
R	External pilot*1

*1: Not compatible with dual 3-port valves.
The 3(R) port is open to the atmosphere.
(Cannot be used for applying pressure or vacuum)

• Base mounted plug-in



10-SS0750
S kit (Serial transmission: EX500)

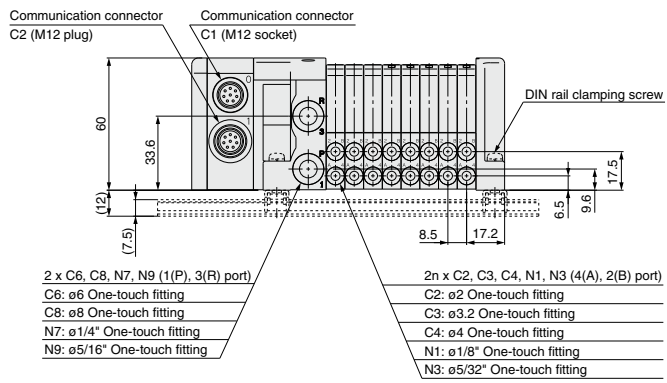
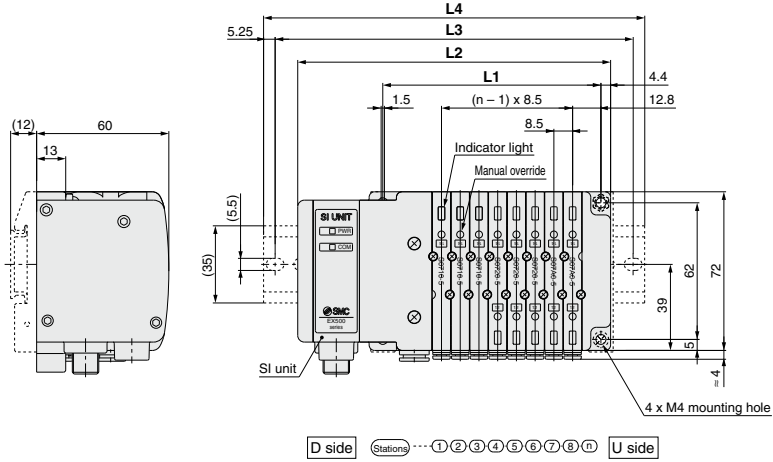

Dimensions

Formula L1 = 8.5n + 31, L2 = 8.5n + 74 n: Station (Maximum 16 stations)

L \ n	2	3	4	5	6	7	8	9	10	11	12	13	14	15	16
L1	48	56.5	65	73.5	82	90.5	99	107.5	116	124.5	133	141.5	150	158.5	167
L2	91	99.5	108	116.5	125	133.5	142	150.5	159	167.5	176	184.5	193	201.5	210
L3	112.5	125	137.5	137.5	150	162.5	162.5	175	187.5	187.5	200	212.5	212.5	225	237.5
L4	123	135.5	148	148	160.5	173	173	185.5	198	198	210.5	223	223	235.5	248

Directional Control Valves
Air Cylinders
Rotary Actuators
Air Grippers
Air Preparation Equipment
Modular F. R.
Pressure Control Equipment
Fittings & Tubing
Flow Control Equipment
Pressure Switches/ Pressure Sensors



Series 10-S0700 Plug-in Manifold Stacking Base

kit (Serial Transmission) EX500 Gateway-type Serial Transmission System 2

How to Order Manifold

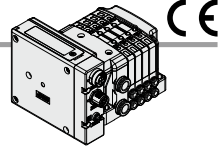

10-SS0750-08 C4 C8 SDA3 N-B

① ② ③ ④ ⑤ ⑥

Clean series

1 Valve stations

Stations	Note
01 1 station	Double wiring
⋮	
16 16 stations	
01 1 station	Specified layout*1 (Available up to 32 solenoids)
⋮	
24 24 stations	

*1: Specified layout: Indicate the wiring specifications on the manifold specification sheet. (Note that 2-position double, 3-position and 4-position valves cannot be used where single wiring has been specified.) In addition, select the option K.

2 A, B port size

Metric size

C2	ø2 One-touch fitting
C3	ø3.2 One-touch fitting
C4	ø4 One-touch fitting
CM*1	Mixed sizes and port plug

Inch size

N1	ø1/8" One-touch fitting
N3	ø5/32" One-touch fitting
NM*1	Mixed sizes and port plug

*1: Indicate the sizes on the manifold specification sheet.

3 P, R port size

Metric size

C6	ø6 One-touch fitting
C8	ø8 One-touch fitting

Inch size

N7	ø1/4" One-touch fitting
N9	ø5/16" One-touch fitting

*1: If an inch size cylinder port is selected, select inch size piping connections for the P and R ports as well.

4 SI unit (Number of outputs, Max. number of valve stations)

SD0	Without SI unit
SDA3	32 outputs*1, 2, 1 to 16 stations (24 stations*2)

*1: When using the SI unit with 32 outputs, use the GW unit compatible with the EX500 Gateway Decentralized System 2 (128 points).

*2: 16 outputs can be set by switching the built-in setting switch.

*3: (): Maximum number of stations for mixed single and double wiring.

*: For SI unit part number, refer to page 444.

5 SI unit (Output polarity)

Nii	(Without SI unit)
N	Negative common

6 Option

Nii	None
B*1	With back pressure check valve (All stations)
D	With DIN bracket, DIN rail with standard length
DO	With DIN bracket, without DIN rail
D□*2	With DIN bracket, DIN rail for □ stations
K*3	Special wiring specification (Except double wiring)
N	With name plate
R*4	External pilot

*1: When a back pressure check valve is used only for specified station, specify the back pressure check valve part number, and specify the station number to which the valve is mounted, on the manifold specification sheet.

*2: □: Specify a longer rail than the length of valve stations.

Example) -D08

In this case, the valves will be mounted on the DIN rail for 8 stations, regardless of the number of manifold stations.

*3: When single wiring and double wiring are mixed, specify wiring type of each station on the manifold specification sheet.

*4: For external pilot option -R, indicate the external pilot specification R for the applicable valves as well.

*: When multiple symbols are specified, indicate them alphabetically. Example) -BKN

*: For manifold optional parts, refer to pages 481 to 484.

*: For manifold exploded view, refer to page 487.

How to Order Valves

10-S07 1 0 □ - 5

Clean series

Type of actuation

Function

Voltage: 24 VDC

Symbol	Specifications
1	2-position single
2	2-position double
A	4-position dual 3-port (N.C. + N.C.) [Exhaust center]
B	4-position dual 3-port (N.O. + N.O.) [Pressure center]
C	4-position dual 3-port (N.C. + N.O.)

*: For symbol, refer to page 423.

Function

Symbol	Specifications
Nii	Standard
R	External pilot*1

*1: Not compatible with dual 3-port valves.

The 3(R) port is open to the atmosphere.
(Cannot be used for applying pressure or vacuum)

Base mounted plug-in

How to Order Manifold Assembly

Specify the part numbers for valves and options together beneath the manifold base part number.

<Example>

Serial transmission kit

10-SS0750-04C4C8SDA3 ... 1 set - Manifold base part no.

* 10-S0720-5 2 sets - 2-position double part no.

* 10-S07A0-5 2 sets - 4-position dual 3-port part no.

Prefix the asterisk to the part numbers of the solenoid valve etc.

Write sequentially from the 1st station on the D side. When part numbers written collectively are complicated, specify on the manifold specification sheet.

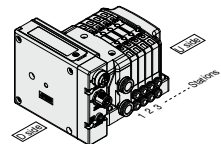

10-SS0750
S kit (Serial transmission: EX500)

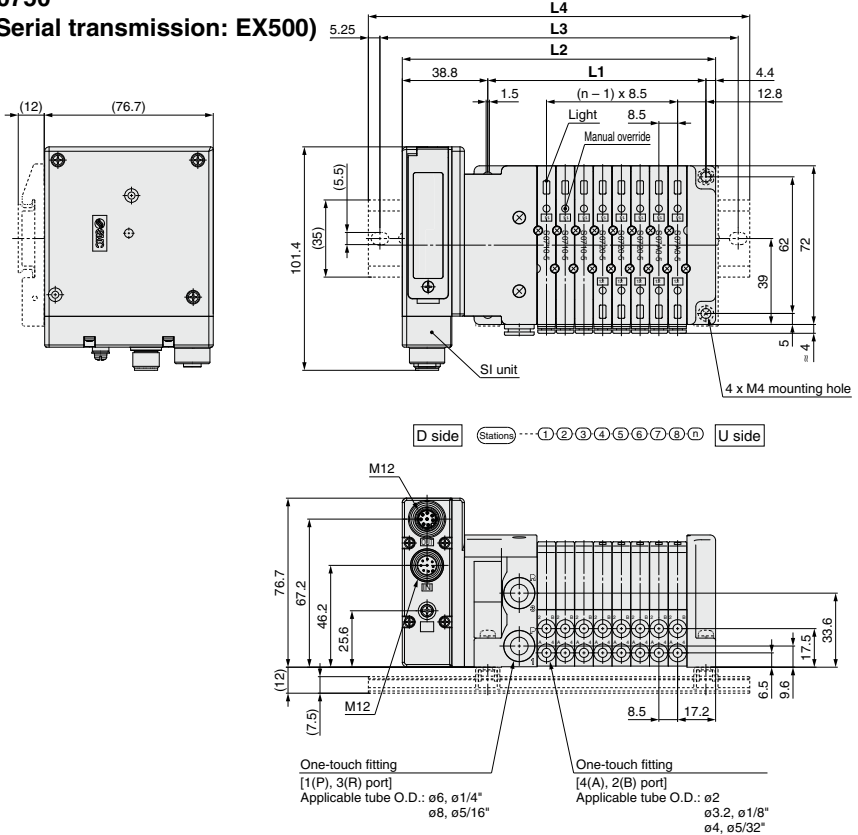

Dimensions

Formula L1 = 8.5n + 31, L2 = 8.5n + 74 n: Station (Maximum 24 stations)

L \ n	1	2	3	4	5	6	7	8	9	10	11	12	13	14	15	16
L1	39.5	48	56.5	65	73.5	82	90.5	99	107.5	116	124.5	133	141.5	150	158.5	167
L2	82.5	91	99.5	108	116.5	125	133.5	142	150.5	159	167.5	176	184.5	193	201.5	210
L3	112.5	112.5	125	137.5	137.5	150	162.5	162.5	175	187.5	187.5	200	212.5	212.5	225	237.5
L4	123	123	135.5	148	148	160.5	173	173	185.5	198	198	210.5	223	223	235.5	248

L \ n	17	18	19	20	21	22	23	24
L1	175.5	184	192.5	201	209.5	218	226.5	235
L2	218.5	227	235.5	244	252.5	261	269.5	278
L3	250	250	262.5	275	275	287.5	300	300
L4	260.5	260.5	273	285.5	285.5	298	310.5	310.5

Directional Control Valves

Air Cylinders

Rotary Actuators

Air Grippers

Air Preparation Equipment

Modular F. R.

Pressure Control Equipment

Fittings & Tubing

Flow Control Equipment

Pressure Switches/ Pressure Sensors



Series 10-S0700 Plug-in Manifold Stacking Base kit (Serial Transmission)

EX250 Integrated-type (For Input/Output) Serial Transmission System

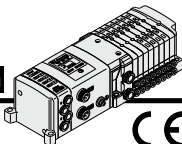

How to Order Manifold

10-SS0750-08 C4 C8 SDQ N [] [] [] - B

Clean series ↓

① Stations

Symbol	Stations
01	1 station
⋮	⋮
24 (Note)	24 stations

Note) The maximum number of stations will be different depending on the wiring specifications.

② Cylinder port size

Symbol	Port size	
C2	With ø2 One-touch fitting	Metric
C3	With ø3.2 One-touch fitting	
C4	With ø4 One-touch fitting	
CM	Mixed sizes and with port plug (Note)	
N1	With ø1/8" One-touch fitting	Inch
N3	With ø5/32" One-touch fitting	
NM	Mixed sizes and with port plug (Note)	

Note) Specify "Mixed sizes and with port plug" on the manifold specification sheet.

③ P, R port size

Symbol	Port size	
C6	With ø6 One-touch fitting	Metric
C8	With ø8 One-touch fitting	
N7	With ø1/4" One-touch fitting	Inch
N9	With ø5/16" One-touch fitting	

Note) If an inch size cylinder port is selected, select inch size piping connections for the P and R ports as well.

④ Kit type

Kit type	Note 2) Symbol	Specifications	Standard station	Max. number of stations for special wiring specifications	Max. number of solenoids	
S kit	For I/O serial transmission	SD0	Without SI unit	1 to 12 stations	24 stations	24
		SDQ	DeviceNet®			
		SDN	PROFIBUS DP			
		SDY	CANopen			
		SDZEN	EtherNet/IP™			
		SDTA	AS-Interface 31 slave, 8 in/8 out, 2 isolated common type	1 to 4 stations	8 stations	8
		SDTB	AS-Interface 31 slave, 4 in/4 out, 2 isolated common type	1 to 2 stations	4 stations	4
		SDTC	AS-Interface 31 slave, 8 in/8 out, 1 common type	1 to 4 stations	8 stations	8
		SDTD	AS-Interface 31 slave, 4 in/4 out, 1 common type	1 to 2 stations	4 stations	4

Note 1) The maximum number of stations is determined by the total number of solenoids.

Note 2) For mixed single and double wirings, enter "K" to the order code options.

Note 3) For SI unit part number, refer to page 444.

Actuation type	Single	Double, Dual 3-port
Number of solenoids	1	2

How to Order Valve

10-S07 1 0 [] - 5

Clean series ↓

Actuation type ↓

Symbol	Specifications
1	2-position single
2	2-position double
A	4-position dual 3-port (N.C. + N.C.) [Exhaust center]
B	4-position dual 3-port (N.O. + N.O.) [Pressure center]
C	4-position dual 3-port (N.C. + N.O.)

Note) For symbol, refer to page 423.

Function ↓

Symbol	Specifications
Nil	Standard
R	External pilot (Note)

Note) Not compatible with dual 3-port valves.

The 3(R) port is released to the atmosphere. (Pressurization and vacuum are not allowed.)

Base mounted plug-in



⑤ SI unit COM.

SI unit COM.		EX250					
		DeviceNet®	PROFIBUS DP	CC-Link	AS-Interface	CANopen	EtherNet/IP™
Nil	+COM.	—	—	○	—	—	—
N	-COM.	—	○	—	○	○	○

Note) The symbol is nil for no SI unit (SD0).

⑥ Input block (for I/O unit only)

Symbol	Specifications
Nil	SI unit/Input block: None (SD0)
0	Input block: None
1	Input block: 1 pc.
⋮	⋮
8	Input block: 8 pcs.

Note) The symbol is nil for no SI unit (SD0).

⑦ Input block type (for I/O unit only)

Symbol	Specifications
Nil	Input block: None
1	M12 2 inputs
2	M12 4 inputs
3	M8 4 inputs (3 pins)

Note) The symbol is nil for no SI unit (SD0).

⑧ Input block COM. (for I/O unit only)

Symbol	Specifications
Nil	PNP sensor input (+COM.) or without input block
N	NPN sensor input (-COM.)

Note) The symbol is nil for no SI unit (SD0).

⑨ Option

Symbol	Specifications
Nil	None
B (Note 2)	With back pressure check valve (All stations)
D	With DIN rail (Rail length: Standard)
D0	Without DIN rail (With bracket)
D□ (Note 3)	With DIN rail Designated length (□: Station)
K (Note 4)	Special wiring specifications (Except double wiring)
N	With name plate
R (Note 5)	External pilot

Note 1) When two or more options are specified, indicate them alphabetically. Example) -BKN

Note 2) When installing a back pressure check valve on the required station, enter the part number and specify the station position on the manifold specification sheet.

Note 3) The available number of stations is larger than the number of manifold stations.

Note 4) Indicate the wiring specifications for mixed single and double wirings.

Note 5) For details, refer to page 481.

* For manifold optional parts, refer to pages 481 to 484.

* For manifold exploded view, refer to page 487.

Refer to the **WEB catalog** for details on the EX250 Integrated-type (For Input/Output) Serial Transmission System.

How to Order Manifold Assembly

Specify the part numbers for valves and options together beneath the manifold base part number.

<Example>

Serial transmission kit

10-SS0750-08C4C8SDQ13N...1 set - Manifold base part no.
 * 10-S0710-5 3 sets - Valve part no. (Stations 1 to 3)
 * 10-S0720-5 2 sets - Valve part no. (Stations 4 to 5)
 * 10-S07A0-5 2 sets - Valve part no. (Stations 6 to 7)
 * SS0700-10A-1 1 set - Blanking plate part no. (Station 8)

Prefix the asterisk to the part no. of the solenoid valve, etc.
 Write sequentially from the 1st station on the D side. When part no. written collectively are complicated, specify on the manifold specification sheet.

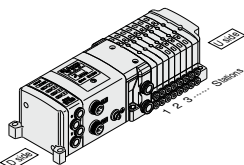

10-SS0750
S kit (Serial transmission: EX250)

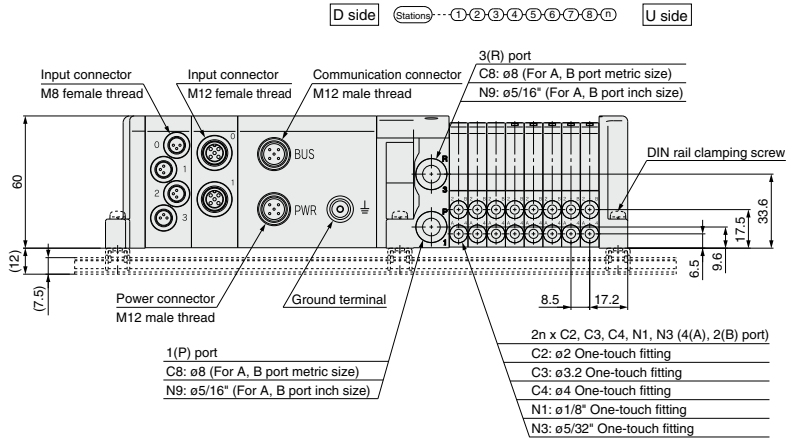
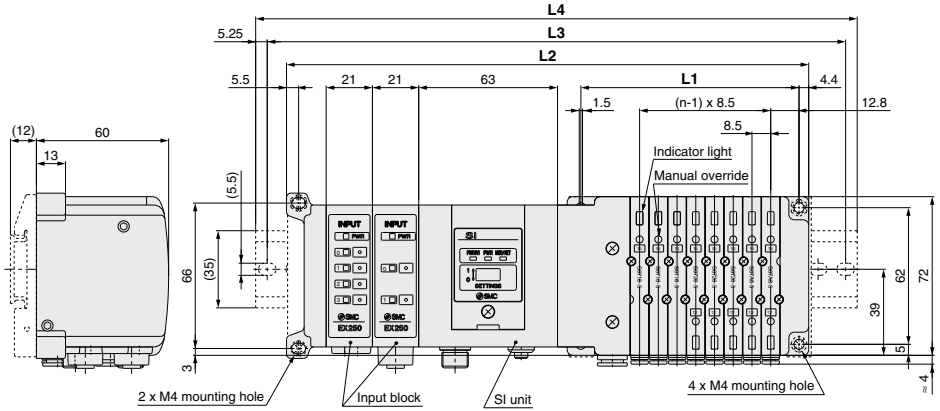

Dimensions

Formula L1 = 8.5n + 31, L2 = 8.5n + 169 (For 2 input blocks, 21 mm is added per 1 pc.) n: Station (Maximum 24 stations)

L \ n	2	3	4	5	6	7	8	9	10	11	12	13	14	15	16
L1	48	56.5	65	73.5	82	90.5	99	107.5	116	124.5	133	141.5	150	158.5	167
L2	186	194.5	203	211.5	220	228.5	237	245.5	254	262.5	271	279.5	288	296.5	305
L3	212.5	225	225	237.5	250	250	262.5	275	275	287.5	300	300	312.5	325	325
L4	223	235.5	235.5	248	260.5	260.5	273	285.5	285.5	298	310.5	310.5	323	335.5	335.5

L \ n	17	18	19	20	21	22	23	24
L1	175.5	184	192.5	201	209.5	218	226.5	235
L2	313.5	322	330.5	339	347.5	356	364.5	373
L3	337.5	350	350	362.5	375	387.5	387.5	400
L4	348	360.5	360.5	373	385.5	398	398	410.5

The 1-port EtherNet/IP compatible SI unit is to be discontinued as of March 2022.
Please consider ordering the 2-port EtherNet/IP compatible SI unit as a substitute.

Kit type
Discontinued model no. SD6ZE ▶ Substitute model no. SD6EA

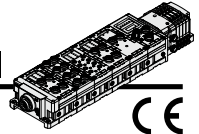

S

Series 10-S0700 Plug-in Manifold Stacking Base kit (Serial Transmission) EX600 Integrated-type (For Input/Output) Serial Transmission System (Fieldbus System)

How to Order Manifold

10-SS0750-08 C4 SD6Q 2 N 1 - B

Clean series

Symbol	Stations
01	1 station
⋮	⋮
24 (Note)	24 stations

Note) Max. number of stations depends on the wiring specifications.

Cylinder port size

Symbol	Port size	
C2	With ø2 One-touch fitting	Metric
C3	With ø3.2 One-touch fitting	
C4	With ø4 One-touch fitting	
CM	Mixed sizes and with port plug (Note)	
N1	With ø1/8" One-touch fitting	Inch
N3	With ø5/32" One-touch fitting	
NM	Mixed sizes and with port plug (Note)	

Note) Indicate the sizes on the manifold specification sheet for CM and NM.

Kit type

Kit type	Symbol	Specifications	Standard station	Max. number of stations for special wiring specifications	Max. number of solenoids
S kit	SD60	Without SI unit	1 to 16 stations	24 stations (Note 3)	32
	SD6Q	DeviceNet®			
	SD6V	CC-Link			
	SD6N	PROFIBUS DP			
	SD6F	PROFINET			
	SD6ZE	EtherNet/IP™ (1 port)			
	SD6EA	EtherNet/IP™ (2 ports)			
	SD6D	EtherCAT			
	SD6WE	EtherNet/IP™ compatible wireless base (Note 4)			
	SD6WF	PROFINET compatible wireless base (Note 4)			
SD6WS	Wireless remote (Note 4)				

Note 1) Max. station number depends on the number of solenoid valve.
Add the option symbol "K" when the combination of single wiring and double wiring is specified.

- When "Without SI unit" is specified, valve plate to connect the manifold and SI unit is not mounted. Refer to page 512 for mounting method.
- I/O unit cannot be chosen without SI unit.

Note 2) For SI unit part number, refer to page 444.

Note 3) Up to 24 stations due to the structure of the manifold. Please note the maximum number of stations is 24 for single wiring, too.

Note 4) The Wireless system is suitable for use only in a country where it is in accordance with the Radio Act and regulations of that country.

Actuation type	Single	Double, Dual 3-port
Number of solenoid valves	1	2

Option

Symbol	Specifications
Nil	None
B (Note 2)	With back pressure check valve (All sta.)
D	With DIN rail (Rail length: Standard)
D0	With DIN rail bracket (Without rail)
D□ (Note 3)	With DIN rail length specified (□: Sta.)
K (Note 4)	Special wiring specifications (Except double wiring)
N	With name plate
R	External pilot

Note 1) When two or more symbols are specified, indicate them alphabetically. Example) -BKN

Note 2) When back pressure check valve is used only for specified station, specify back pressure check valve part number, and specify station number to which the valve is mounted on the manifold specification sheet.

Note 3) Specified station number shall be longer than manifold station number.

Note 4) When single wiring and double wiring are mixed, specify wiring type of each station on the manifold specification sheet.

Note 5) When "Without SI unit (SD6Q)" is specified, "With DIN rail (D)" cannot be selected.

I/O unit station number

Nil	None
1	1 station
⋮	⋮
9	9 stations

Note 1) The symbol is nil for no SI unit.

Note 2) SI unit is not included in I/O unit station number.

Note 3) When I/O unit is selected, it is shipped separately, and assembled by customer. Refer to the attached operation manual for mounting method.

SI unit COM.

Nil	+COM.
N	-COM.

Note) The symbol is nil for no SI unit.

End plate type

Nil	No end plate
2	M12 power supply connector, B-coded
3	7/8 inch power supply connector
4	M12 power supply connector IN/OUT, A-coded, Pin arrangement 1
5	M12 power supply connector IN/OUT, A-coded, Pin arrangement 2

Note) The symbol is nil for no SI unit.

• The pin layout for "4" and "5" pin connector is different.

Refer to the Fieldbus System (For Input/Output) catalog CAT.E02-24 for details on the EX600 Integrated-type (For I/O) Serial Transmission System.

How to Order Manifold Assembly (Example)

Example

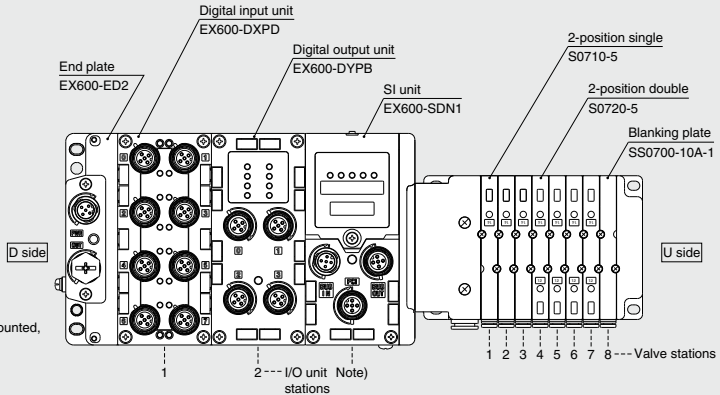

For the I/O unit part number mounted, refer to CAT.E02-24 catalog.

- Digital input unit
- Digital output unit
- Analog input unit

Serial transmission kit

10-SS0750-08C4SD6Q2N2	1 set	Manifold base part number
*10-S0710-5	3 sets	Valve part number (Stations 1 to 3)
*10-S0720-5	4 sets	Valve part number (Stations 4 to 7)
*SS0700-10A-1	1 set	Blanking plate number (Station 8)
*EX600-DXPD	1 set	I/O unit part number (Station 1)
*EX600-DYPB	1 set	I/O unit part number (Station 2)

The asterisk denotes the symbol for assembly. Prefix it to the part no. of the solenoid valve, etc.

Enter in order starting from the first station on the D side. If arrangement becomes complicated, specify on the manifold specification sheet.

Enter in order starting from the first station on the D side.

Note) Do not enter the SI unit part number and the end plate part number together.

How to Order Valve

10-S0710-5

Clean series

Actuation type

Coil voltage

5 24 VDC

Function

Symbol	Specifications
NII	Standard
R	External pilot ^{Note)}

Note) Not compatible with dual 3-port valves. The 3(R) port is released to the atmosphere. (Pressurization and vacuum are not allowed.)

Base mounted plug-in

1	2-position single	A	4-position dual 3-port valve (N.C. + N.C.) [Exhaust center]
	2-position double	B	4-position dual 3-port valve (N.O. + N.O.) [Pressure center]
2	2-position single	C	4-position dual 3-port valve (N.C. + N.O.)
	2-position double		



Series 10-S0700 Plug-in Manifold Stacking Base

kit (Serial Transmission) EX600 Integrated-type (For Input/Output) Serial Transmission System (Fieldbus System)

Power Supply with M12 Connector

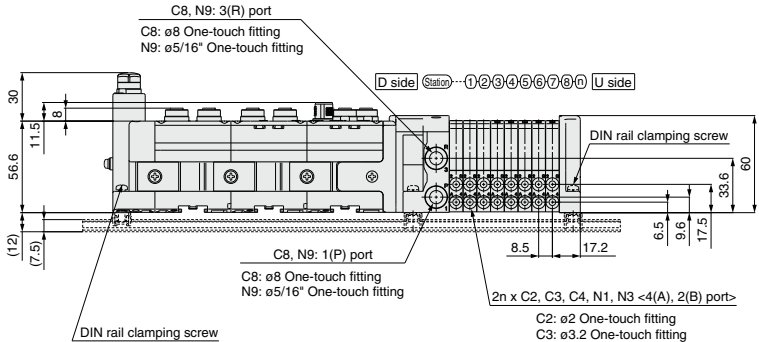
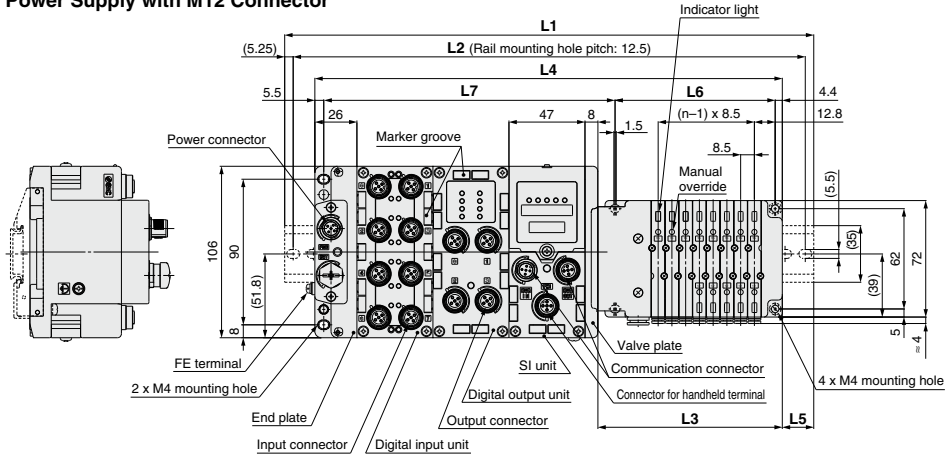

$L2 = L1 - 10.5$
 $L3 = 8.5 \times n1 + 46$
 $L4 = L3 + 81 + 47 \times n2$
 $L5 = (L1 - L4) / 2$
 $L6 = 8.5 \times n1 + 31$
 $L7 = 47 \times n2 + 86.1$

- C2: ø2 One-touch fitting
- C3: ø3.2 One-touch fitting
- C4: ø4 One-touch fitting
- N1: ø1/8" One-touch fitting
- N3: ø5/32" One-touch fitting

L1: DIN Rail Overall Length

I/O unit stations (n2) \ Valve stations (n1)	1	2	3	4	5	6	7	8	9	10	11	12	13	14	15	16	17	18	19	20	21	22	23	24
0	173	185.5	185.5	198	210.5	210.5	223	235.5	235.5	248	260.5	260.5	273	285.5	285.5	298	310.5	310.5	323	335.5	335.5	348	360.5	373
1	223	223	235.5	248	248	260.5	273	273	285.5	298	298	310.5	323	323	335.5	348	360.5	360.5	373	385.5	385.5	398	410.5	410.5
2	260.5	273	285.5	285.5	298	310.5	310.5	323	335.5	348	348	360.5	373	373	385.5	398	398	410.5	423	423	435.5	448	448	460.5
3	310.5	323	335.5	335.5	348	360.5	360.5	373	385.5	385.5	398	410.5	410.5	423	435.5	435.5	448	460.5	460.5	473	485.5	485.5	498	510.5
4	360.5	373	373	385.5	398	398	410.5	423	423	435.5	448	448	460.5	473	473	485.5	498	498	510.5	523	535.5	535.5	548	560.5
5	410.5	410.5	423	435.5	435.5	448	460.5	460.5	473	485.5	485.5	498	510.5	523	523	535.5	548	548	560.5	573	573	585.5	598	598
6	448	460.5	473	473	485.5	498	510.5	510.5	523	535.5	535.5	548	560.5	560.5	573	585.5	585.5	598	610.5	610.5	623	635.5	635.5	648
7	498	510.5	523	523	535.5	548	548	560.5	573	573	585.5	598	598	610.5	623	623	635.5	648	648	660.5	673	673	685.5	698
8	548	560.5	560.5	573	585.5	585.5	598	610.5	610.5	623	635.5	635.5	648	660.5	660.5	673	685.5	698	698	710.5	723	723	735.5	748
9	598	598	610.5	623	623	635.5	648	648	660.5	673	685.5	685.5	698	710.5	710.5	723	735.5	735.5	748	760.5	760.5	773	785.5	785.5

Power Supply with 7/8 Inch Connector

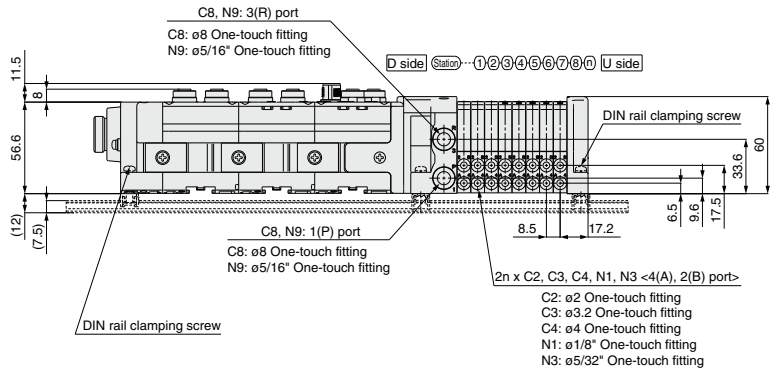
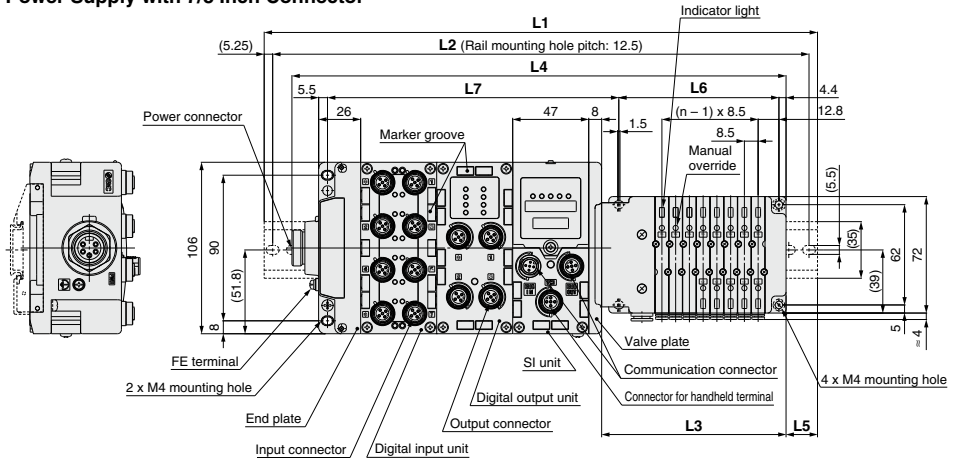

$L2 = L1 - 10.5$
 $L3 = 8.5 \times n1 + 46$
 $L4 = L3 + 97.5 + 47 \times n2$
 $L5 = (L1 - L4) / 2$
 $L6 = 8.5 \times n1 + 31$
 $L7 = 47 \times n2 + 86.1$

L1: DIN Rail Overall Length

I/O unit stations (n2) \ Valve stations (n1)	1	2	3	4	5	6	7	8	9	10	11	12	13	14	15	16	17	18	19	20	21	22	23	24
0	185.5	198	210.5	210.5	223	235.5	235.5	248	260.5	260.5	273	285.5	285.5	298	310.5	310.5	323	335.5	335.5	348	360.5	360.5	373	385.5
1	235.5	248	248	260.5	273	273	285.5	298	298	310.5	323	323	335.5	348	348	360.5	373	385.5	385.5	398	410.5	410.5	423	435.5
2	285.5	285.5	298	310.5	310.5	323	335.5	335.5	348	360.5	373	373	385.5	398	398	410.5	423	423	435.5	448	448	460.5	473	473
3	323	335.5	348	360.5	360.5	373	385.5	385.5	398	410.5	410.5	423	435.5	448	448	460.5	460.5	473	485.5	485.5	498	510.5	510.5	523
4	373	385.5	398	398	410.5	423	423	435.5	448	448	460.5	473	473	485.5	498	498	510.5	523	523	535.5	548	560.5	560.5	573
5	423	435.5	435.5	448	460.5	460.5	473	485.5	485.5	498	510.5	510.5	523	535.5	548	548	560.5	573	573	585.5	598	598	610.5	623
6	473	473	485.5	498	498	510.5	523	535.5	535.5	548	560.5	560.5	573	585.5	585.5	598	610.5	610.5	623	635.5	635.5	648	660.5	660.5
7	523	523	535.5	548	548	560.5	573	573	585.5	598	598	610.5	623	623	635.5	648	648	660.5	673	673	685.5	698	698	710.5
8	560.5	573	585.5	585.5	598	610.5	610.5	623	635.5	635.5	648	660.5	660.5	673	685.5	685.5	698	710.5	723	723	735.5	748	748	760.5
9	610.5	623	623	635.5	648	648	660.5	673	673	685.5	698	710.5	710.5	723	735.5	735.5	748	760.5	760.5	773	785.5	785.5	798	810.5

Directional Control Valves
Air Cylinders
Rotary Actuators
Air Grippers
Air Preparation Equipment
Modular F. R.
Pressure Control Equipment
Fittings & Tubing
Flow Control Equipment
Pressure Switches/ Pressure Sensors

Plug-in Manifold Stacking Base

D-sub Connector

F kit

Plug-in Manifold
Stacking Base



MIL Standard

- 25 pins
- Cable length:
1.5 m, 3 m, 5 m

Connector mounting
direction: Top or side
selectable

Page 457



Directional
Control Valves

Air Cylinders

Rotary Actuators

Air Grippers

Air Preparation
Equipment

Modular F. R.

Pressure Control
Equipment

Fittings & Tubing

Flow Control
Equipment

Pressure Switches/
Pressure Sensors

F Series 10-S0700 Plug-in Manifold Stacking Base kit (D-sub Connector)

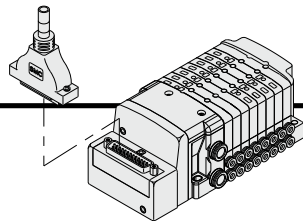

- The D-sub connector reduces installation labor for electrical connections.
- Using the D-sub connector (25P) conforming to MIL standard permits the use of commercial connectors and gives a wide interchangeability.
- Top or side receptacle position can be selected in accordance with the available mounting space.

Electrical Wiring Specifications

D-sub connector

As the standard electrical wiring specifications, double wiring (connected to SOL.A and SOL.B) is adopted for the internal wiring of each station for 12 stations or less, regardless of valve and option types. Mixed single and double wiring is available as an option. For details, refer to "Special Wiring Specifications" (Option) below.

D-sub connector assembly
wire color (AXT100-DS25-030 050)

Terminal no.	Polarity	Lead wire color	Dot marking
Station 1 SOL.A 1	(-)	(+) Black	None
Station 1 SOL.B 14	(+)	Yellow	Black
Station 2 SOL.A 2	(-)	(+) Brown	None
Station 2 SOL.B 15	(+)	Pink	Black
Station 3 SOL.A 3	(-)	(+) Red	None
Station 3 SOL.B 16	(+)	Blue	White
Station 4 SOL.A 4	(-)	(+) Orange	None
Station 4 SOL.B 17	(+)	Purple	None
Station 5 SOL.A 5	(-)	(+) Yellow	None
Station 5 SOL.B 18	(+)	Gray	None
Station 6 SOL.A 6	(-)	(+) Pink	None
Station 6 SOL.B 19	(+)	Orange	Black
Station 7 SOL.A 7	(-)	(+) Blue	None
Station 7 SOL.B 20	(+)	Red	White
Station 8 SOL.A 8	(-)	(+) Purple	White
Station 8 SOL.B 21	(+)	Brown	White
Station 9 SOL.A 9	(-)	(+) Gray	Black
Station 9 SOL.B 22	(+)	Pink	Red
Station 10 SOL.A 10	(-)	(+) White	Black
Station 10 SOL.B 23	(+)	Gray	Red
Station 11 SOL.A 11	(-)	(+) White	Red
Station 11 SOL.B 24	(+)	Black	White
Station 12 SOL.A 12	(-)	(+) Yellow	Red
Station 12 SOL.B 25	(+)	White	None
COM. 13	(+)	(-) Orange	Red

Note) Mounting valve has no polarity. It can also be used as a negative common.

Special Wiring Specifications (Option) [-K]

(25P)

Mixed single and double wiring are available as an option. The maximum number of manifold stations is determined by the number of solenoids. Count one point for a single solenoid type and two points for a double solenoid type. The total number of solenoids (points) must not exceed 24.

1. How to Order valve
Indicate an option symbol, -K, for the manifold part number and be sure to specify the mounting position and number of stations of the single and double wiring on the manifold specification sheet.

2. Wiring specifications
Connector terminal numbers are connected from solenoid station 1 on the A side in the order indicated by the arrows without skipping any terminal numbers.

Cable Assembly

AXT100-DS25-030 050

(The D-sub connector cable assemblies can be ordered with manifolds. Refer to "How to Order Manifold.")

D-sub connector cable assembly
Wire Color by Terminal No.

Terminal no.	Lead wire color	Dot marking
1	Black	None
2	Brown	None
3	Red	None
4	Orange	None
5	Yellow	None
6	Pink	None
7	Blue	None
8	Purple	White
9	Gray	Black
10	White	Black
11	White	Red
12	Yellow	Red
13	Orange	Red
14	Yellow	Black
15	Pink	Black
16	Blue	White
17	Purple	None
18	Gray	None
19	Orange	Black
20	Red	White
21	Brown	White
22	Pink	Red
23	Gray	Red
24	Black	White
25	White	None

D-sub Connector Cable Assembly (Option)

Cable length (L)	Assembly part no.	Note
1.5 m	AXT100-DS25-015	
3 m	AXT100-DS25-030	Cable 0.3 mm ² x 25 cores
5 m	AXT100-DS25-050	

* For other commercial connectors, use a 25-pin type with female connector conforming to MIL-C-24308.
* Cannot be used for movable wiring.

Electrical Characteristics

Item	Property
Conductor resistance Ω/km, 20°C	65 or less
Voltage limit V, 1 minute, AC	1000
Insulation resistance MΩ/km, 20°C	5 or more

Note) The minimum bending radius of D-sub connector cable is 20 mm.

Example of connector manufacturers

- Fujitsu Limited
- Japan Aviation Electronics Industry, Limited
- J.S.T. Mfg. Co., Ltd.
- HIROSE ELECTRIC CO., LTD.





How to Order Manifold

10-SS0750-08 C4 C8 FD1-B

Clean series

Symbol	Stations
02	2 stations
⋮	⋮
24 (Note)	24 stations

Note) The maximum number of stations will be different depending on the wiring specifications.

Cylinder port size

Symbol	Port size	
C2	With ø2 One-touch fitting	Metric
C3	With ø3.2 One-touch fitting	
C4	With ø4 One-touch fitting	
CM	Mixed sizes and with port plug (Note)	
N1	With ø1/8" One-touch fitting	Inch
N3	With ø5/32" One-touch fitting	
NM	Mixed sizes and with port plug (Note)	

Note) Indicate the sizes on the manifold specification sheet for CM and NM.

P, R port size

Symbol	Port size	
C6	With ø6 One-touch fitting	Metric
C8	With ø8 One-touch fitting	
N7	With ø1/4" One-touch fitting	Inch
N9	With ø5/16" One-touch fitting	

Note) If an inch size cylinder port is selected, select inch size piping connections for the P and R ports as well.

Option

Symbol	Specifications
Nil	None
B (Note 2)	With back pressure check valve (All stations)
D	With DIN rail (Rail length: Standard)
D0	Without DIN rail (With bracket)
D□ (Note 3)	With DIN rail Designated length (□: Station)
K (Note 4)	Special wiring specifications (Except double wiring)
N	With name plate
R (Note 5)	External pilot

Note 1) When two or more options are specified, indicate them alphabetically. Example) -BKN
 Note 2) When installing a back pressure check valve on the required station, enter the part number and specify the station position on the manifold specification sheet.

Note 3) The available number of stations is larger than the number of manifold stations.

Note 4) Indicate the wiring specifications for mixed single and double wirings.

Note 5) For details, refer to page 481.

* For manifold optional parts, refer to pages 481 to 484.

* For manifold exploded view, refer to page 487.

Kit type/Cable length

Kit type	Symbol	Specifications	Standard station	Max. number of stations for special wiring specifications	Max. number of solenoids
F kit	FD0	D-sub connector (25P), without cable	1 to 12 stations	24 stations	24
	FD1	D-sub connector (25P), with 1.5 m cable			
	FD2	D-sub connector (25P), with 3.0 m cable			
	FD3	D-sub connector (25P), with 5.0 m cable			

Note) The maximum number of stations is determined by the total number of solenoids. For mixed single and double wirings, enter "K" to the order code options.

Actuation type	Single	Double, Dual 3-port
Number of solenoids	1	2

How to Order Valve

10-S07 1 0 □ - 5

Clean series

Actuation type

Symbol	Specifications
1	2-position single
2	2-position double
A	4-position dual 3-port (N.C. + N.C.) [Exhaust center]
B	4-position dual 3-port (N.O. + N.O.) [Pressure center]
C	4-position dual 3-port (N.C. + N.O.)

Note) For symbol, refer to page 423.

Voltage

Symbol	Specifications
5	24 VDC
6	12 VDC

Function

Symbol	Specifications
Nil	Standard
R	External pilot (Note)

Note) Not compatible with dual 3-port valves. The 3(R) port is released to the atmosphere. (Pressurization and vacuum are not allowed.)

Base mounted plug-in

How to Order Manifold Assembly

Specify the part numbers for valves and options together beneath the manifold base part number.

<Example>

D-sub connector kit

10-SS0750-08C4C8FD1...1 set - Manifold base part no.
 = 10-S0710-53 sets - Valve part no. (Stations 1 to 3)
 = 10-S0720-52 sets - Valve part no. (Stations 4 to 5)
 = 10-S07A0-52 sets - Valve part no. (Stations 6 to 7)
 = SS0700-10A-11 set - Blanking plate part no. (Station 8)

Prefix the asterisk to the part no. of the solenoid valve, etc.
 Write sequentially from the 1st station on the D side. When part no. written collectively are complicated, specify on the manifold specification sheet.

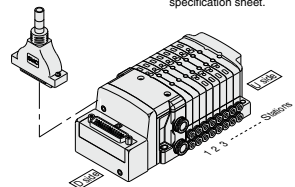

Directional Control Valves

Air Cylinders

Rotary Actuators

Air Grippers

Air Preparation Equipment

Modular F. R.

Pressure Control Equipment

Fittings & Tubing

Flow Control Equipment

Pressure Switches/ Pressure Sensors

F

Series 10-S0700 kit (D-sub Connector)

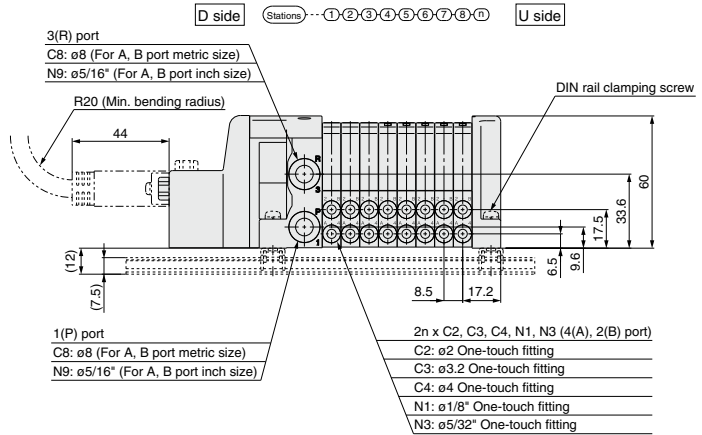
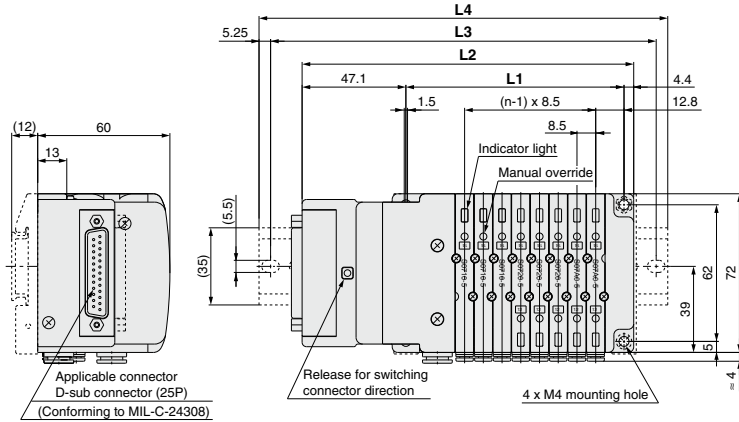

Dimensions

Formula L1 = 8.5n + 31, L2 = 8.5n + 82.5 n: Station (Maximum 24 stations)

L \ n	2	3	4	5	6	7	8	9	10	11	12	13	14	15	16	17	18	19	20	21	22	23	24
L1	48	56.5	65	73.5	82	90.5	99	107.5	116	124.5	133	141.5	150	158.5	167	175.5	184	192.5	201	209.5	218	226.5	235
L2	99.5	108	116.5	125	133.5	142	150.5	159	167.5	176	184.5	193	201.5	210	218.5	227	235.5	244	252.5	261	269.5	278	286.5
L3	125	137.5	137.5	150	162.5	162.5	175	187.5	187.5	200	212.5	225	237.5	250	250	262.5	275	275	287.5	300	300	312.5	312.5
L4	135.5	148	148	160.5	173	173	185.5	198	198	210.5	223	223	235.5	248	260.5	260.5	273	285.5	285.5	298	310.5	310.5	323

Plug-in Manifold Stacking Base

Flat Ribbon Cable

P kit

Plug-in Manifold
Stacking Base



MIL Standard

■ 26 pins, 20 pins

■ Cable length
1.5 m, 3 m, 5 m

Connector mounting
direction: Top or side
selectable

Page 461



Directional
Control Valves

Air Cylinders

Rotary Actuators

Air Grippers

Air Preparation
Equipment

Modular F. R.

Pressure Control
Equipment

Fittings & Tubing

Flow Control
Equipment

Pressure Switches/
Pressure Sensors

P Series 10-S0700 Plug-in Manifold Stacking Base kit (Flat Ribbon Cable)

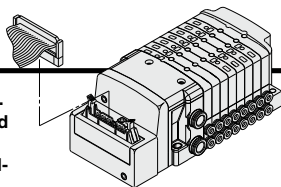

- Flat ribbon cable connector reduces installation labor for electrical connection.
- Using the connector for flat ribbon cable (26P, 20P) conforming to MIL standard permits the use of commercial connectors and gives a wide interchangeability.
- Top or side receptacle position can be selected in accordance with the available mounting space.

Electrical Wiring Specifications

Flat ribbon cable connector

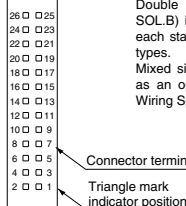

Double wiring (connected to SOL.A and SOL.B) is adopted for the internal wiring of each station, regardless of valve and option types.
Mixed single and double wiring is available as an option. For details, refer to "Special Wiring Specifications" (Option) below.

Connector terminal no.

Triangle mark indicator position

<26P>

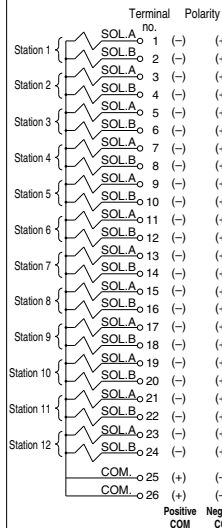

Positive COM Negative COM

Note) Mounting valve has no polarity. It can also be used as a negative common.

<20P>

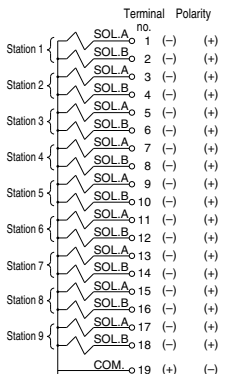

Positive COM Negative COM

Cable Assembly

AXT100-FC²⁰₂₆¹₂³

(Type 26P flat ribbon cable connector assemblies can be ordered) with manifolds. Refer to "How to Order Manifold."

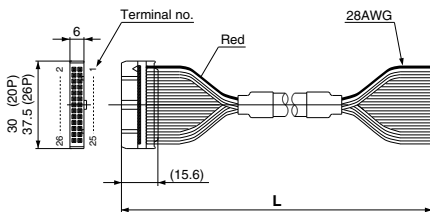

Flat Ribbon Cable Connector Assembly (Option)

Cable length (L)	Assembly part no.	
	26P	20P
1.5 m	AXT100-FC26-1	AXT100-FC20-1
3 m	AXT100-FC26-2	AXT100-FC20-2
5 m	AXT100-FC26-3	AXT100-FC20-3

- * For other commercial connectors, use a 20- or 26-pin type with strain relief conforming to MIL-C-83503.
- * Cannot be used for movable wiring.

Example of connector manufacturers

- HIROSE ELECTRIC CO., LTD.
- 3M Japan Limited
- Fujitsu Limited
- Japan Aviation Electronics Industry, Limited
- J.S.T. Mfg. Co., Ltd.
- Oki Electric Cable Co., Ltd.

Special Wiring Specifications (Option) [-K]

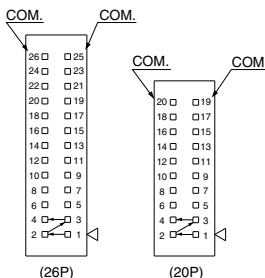

Mixed single and double wiring are available as an option. The maximum number of manifold stations is determined by the number of solenoids. Count one point for a single solenoid type and two points for a double solenoid type. The total number of solenoids (points) must not exceed 24 for 26P, 18 for 20P.

1. How to Order valve

Indicate an option symbol, -K, for the manifold part number and be sure to specify the mounting position and number of stations of the single and double wiring on the manifold specification sheet.

2. Wiring specifications

Connector terminal numbers are connected from solenoid station 1 on the A side in the order indicated by the arrows without skipping any terminal numbers.



How to Order Manifold

10-SS0750-08 C4 C8 PD1-B

Clean series

Symbol	Stations
02	2 stations
⋮	⋮
24	24 stations

Note) The maximum number of stations will be different depending on the wiring specifications.

Cylinder port size

Symbol	Port size	
C2	With ø2 One-touch fitting	Metric
C3	With ø3.2 One-touch fitting	
C4	With ø4 One-touch fitting	
CM	Mixed sizes and with port plug ^{Note)}	
N1	With ø1/8" One-touch fitting	Inch
N3	With ø5/32" One-touch fitting	
N7	With ø1/4" One-touch fitting	
NM	Mixed sizes and with port plug ^{Note)}	

Note) Indicate the sizes on the manifold specification sheet for CM and NM.

P, R port size

Symbol	Port size	
C6	With ø6 One-touch fitting	Metric
C8	With ø8 One-touch fitting	
N7	With ø1/4" One-touch fitting	Inch
N9	With ø5/16" One-touch fitting	

Note) If an inch size cylinder port is selected, inch size piping connections for the P and R ports as well.

Option

Symbol	Specifications
Nil	None
B ^{Note 2)}	With back pressure check valve (All stations)
D	With DIN rail (Rail length: Standard)
D0	Without DIN rail (With bracket)
D <input type="checkbox"/> ^{Note 3)}	With DIN rail Designated length (□: Station)
K ^{Note 4)}	Special wiring specifications (Except double wiring)
N	With name plate
R ^{Note 5)}	External pilot

Note 1) When two or more options are specified, indicate them alphabetically. Example) -BKN
 Note 2) When installing a back pressure check valve on the required station, enter the part number and specify the station position on the manifold specification sheet.
 Note 3) The available number of stations is larger than the number of manifold stations.
 Note 4) Indicate the wiring specifications for mixed single and double wirings.
 Note 5) For details, refer to page 481.

* For manifold optional parts, refer to pages 481 to 484.

* For manifold exploded view, refer to page 487.

Kit type/Cable length

Kit type	Symbol	Specifications	Standard station	Max. number of stations for special wiring specifications	Max. number of solenoids
P kit	PD0	Flat ribbon cable (26P), without cable	1 to 12 stations	24 stations	24
	PD1	Flat ribbon cable (26P), with 1.5 m cable			
	PD2	Flat ribbon cable (26P), with 3.0 m cable			
	PD3	Flat ribbon cable (26P), with 5.0 m cable			
	PDC	Flat ribbon cable (20P), without cable			

Note) The maximum number of stations is determined by the total number of solenoids. For mixed single and double wirings, enter "K" to the order code options.

Actuation type	Single	Double, Dual 3-port
Number of solenoids	1	2

How to Order Valve

10-S07 1 0 - 5

Clean series

Actuation type

Symbol	Specifications
1	2-position single
2	2-position double
A	4-position dual 3-port (N.C. + N.C.) [Exhaust center]
B	4-position dual 3-port (N.O. + N.O.) [Pressure center]
C	4-position dual 3-port (N.C. + N.O.)

Note) For symbol, refer to page 423.

Voltage

Symbol	Specifications
5	24 VDC
6	12 VDC

Function

Symbol	Specifications
Nil	Standard
R	External pilot ^{Note)}

Note) Not compatible with dual 3-port valves. The 3(R) port is released to the atmosphere. (Pressurization and vacuum are not allowed.)

Base mounted plug-in

How to Order Manifold Assembly

Specify the part numbers for valves and options together beneath the manifold base part number.

<Example>

Flat ribbon cable kit

- 10-SS0750-08C4C8PD1-... 1 set - Manifold base part no.
- * 10-S0710-5 2 sets - Valve part no. (Stations 1 to 3)
- * 10-S0720-5 4 sets - Valve part no. (Stations 4 to 5)
- * 10-S07A0-5 1 set - Valve part no. (Stations 6 to 7)
- * SS0700-10A-1 1 set - Blanking plate part no. (Station 8)

Prefix the asterisk to the part no. of the solenoid valve, etc.

Write sequentially from the 1st station on the D side. When part no. written collectively are complicated, specify on the manifold specification sheet.

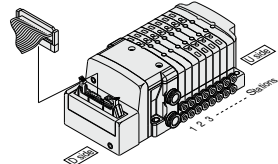

Directional Control Valves

Air Cylinders

Rotary Actuators

Air Grippers

Air Preparation Equipment

Modular F. R.

Pressure Control Equipment

Fittings & Tubing

Flow Control Equipment

Pressure Switches/ Pressure Sensors

P

Series 10-S0700 kit (Flat Ribbon Cable)

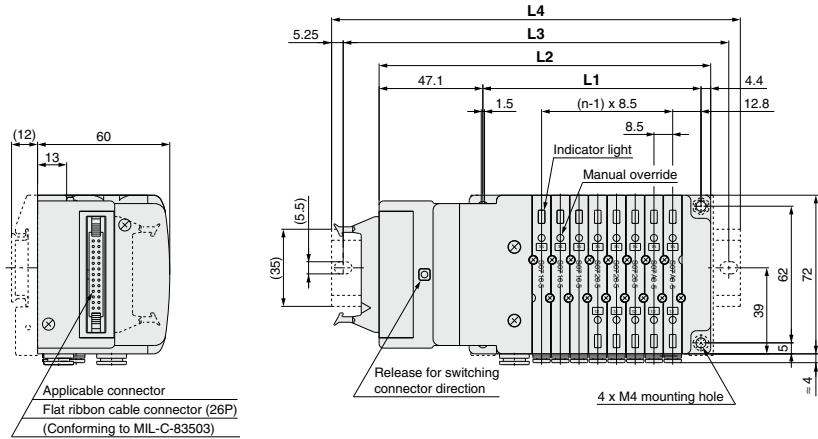

D side Stations 1 2 3 4 5 6 7 8 9 U side

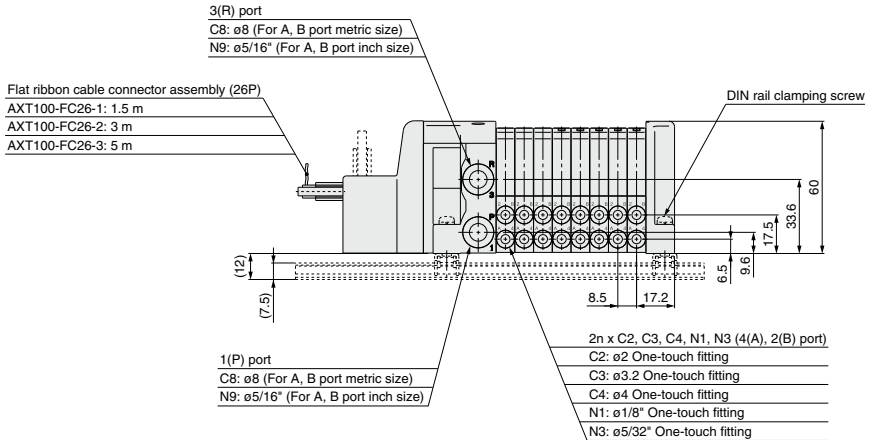

Dimensions

Formula L1 = 8.5n + 31, L2 = 8.5n + 82.5 n: Station (Maximum 24 stations)

L	n	2	3	4	5	6	7	8	9	10	11	12	13	14	15	16	17	18	19	20	21	22	23	24
L1	48	56.5	65	73.5	82	90.5	99	107.5	116	124.5	133	141.5	150	158.5	167	175.5	184	192.5	201	209.5	218	226.5	235	
L2	99.5	108	116.5	125	133.5	142	150.5	159	167.5	176	184.5	193	201.5	210	218.5	227	235.5	244	252.5	261	269.5	278	286.5	
L3	125	137.5	150	162.5	175	187.5	200	212.5	225	237.5	250	262.5	275	287.5	300	312.5	325	337.5	350	362.5	375	387.5	400	412.5
L4	135.5	148	160.5	173	185.5	198	210.5	223	235.5	248	260.5	273	285.5	298	310.5	323	335.5	348	360.5	373	385.5	398	410.5	423

J

Series 10-S0700

kit (PC Wiring System Compatible Flat Ribbon Cable)

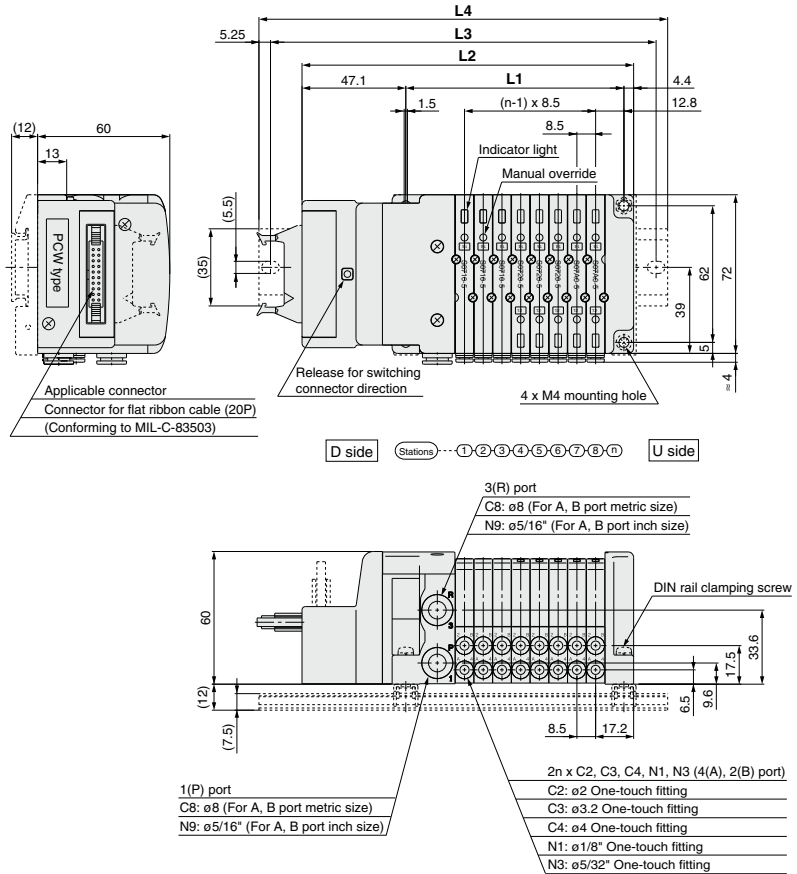

Dimensions

Formula L1 = 8.5n + 31, L2 = 8.5n + 82.5 n: Station (Maximum 16 stations)

L \ n	2	3	4	5	6	7	8	9	10	11	12	13	14	15	16
L1	48	56.5	65	73.5	82	90.5	99	107.5	116	124.5	133	141.5	150	158.5	167
L2	99.5	108	116.5	125	133.5	142	150.5	159	167.5	176	184.5	193	201.5	210	218.5
L3	125	137.5	137.5	150	162.5	162.5	175	187.5	187.5	200	212.5	212.5	225	237.5	250
L4	135.5	148	148	160.5	173	173	185.5	198	198	210.5	223	223	235.5	248	260.5

Plug-in Manifold Stacking Base

Terminal Block Box

T kit

Plug-in Manifold
Stacking Base

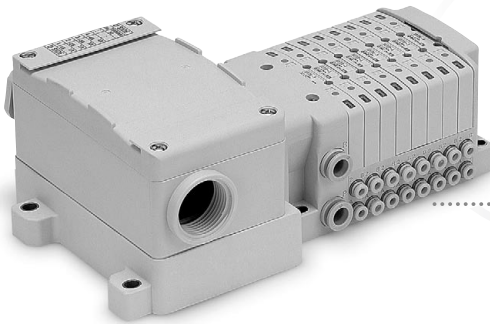

With
Terminal
Block Box

Page 469



Directional
Control Valves

Air Cylinders

Rotary Actuators

Air Grippers

Air Preparation
Equipment

Modular F. R.

Pressure Control
Equipment

Fittings & Tubing

Flow Control
Equipment

Pressure Switches/
Pressure Sensors

T

Series 10-S0700 Plug-in Manifold Stacking Base kit (Terminal Block Box)

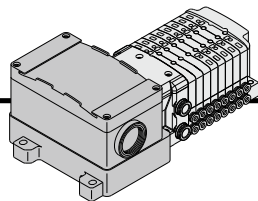

- This kit has a small terminal box inside a junction box. The electrical entry port (G3/4) permits connection of conduit fittings.

Terminal Block Connection

Step 1. How to remove terminal block cover

Loosen the 4 mounting screws (M4) and open the terminal block cover.

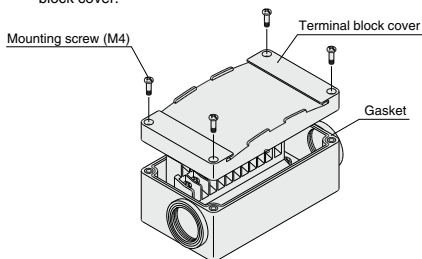

Step 3. How to replace terminal block cover

Securely tighten the screws with the torque shown in the table below, after confirming that the gasket is installed correctly.

Proper tightening torque (N·m)
0.7 to 1.2

Step 2. The diagram below shows the terminal block wiring schematic. All stations are provided with double solenoid wiring.

Connect each wire to the power supply side, according to the markings provided inside the terminal block.

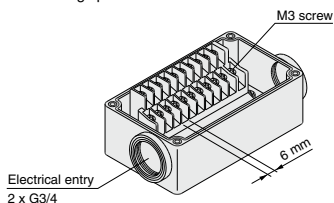

- Applicable crimped terminal: 1.25-3S, 1.25Y-3, 1.25Y-3N, 1.25Y-3.5

Electrical Wiring Specifications

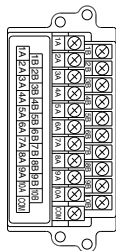

Double wiring (connected to SOL A and SOL B) is adopted for the internal wiring of each station, regardless of valve and option types. Mixed single and double wiring is available as an option.

Note) Mounting valve has no polarity. It can also be used as a negative common.

Standard wiring

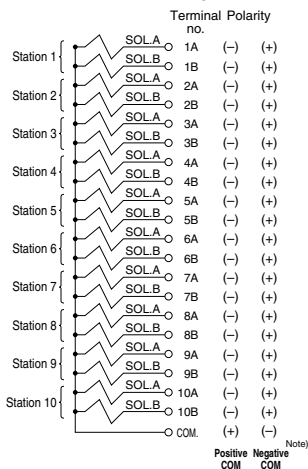

Special Wiring Specifications (Option) [-K]

Mixed single and double wiring are available as an option. The maximum number of manifold stations is determined by the number of solenoids. Count one point for a single solenoid type and two points for a double solenoid type. The total number of solenoids (points) must not exceed 20.

1. How to Order valve

Indicate an option symbol, -K, for the manifold part number and be sure to specify the mounting position and number of stations of the single and double wiring on the manifold specification sheet.

2. Wiring specifications

Connector terminal numbers are connected from solenoid station 1 on the A side in the order indicated by the arrows without skipping any terminal numbers.





How to Order Manifold

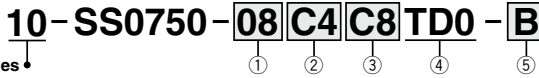

① Stations

Symbol	Stations
01	1 station
⋮	⋮
20 ^{Note)}	20 stations

Note) The maximum number of stations will be different depending on the wiring specifications.

② Cylinder port size

Symbol	Port size	
C2	With ø2 One-touch fitting	Metric
C3	With ø3.2 One-touch fitting	
C4	With ø4 One-touch fitting	
CM	Mixed sizes and with port plug ^{Note)}	
N1	With ø1/8" One-touch fitting	Inch
N3	With ø5/32" One-touch fitting	
NM	Mixed sizes and with port plug ^{Note)}	

Note) Specify "Mixed sizes and with port plug" on the manifold specification sheet.

③ P, R port size

Symbol	Port size	
C6	With ø6 One-touch fitting	Metric
C8	With ø8 One-touch fitting	
N7	With ø1/4" One-touch fitting	Inch
N9	With ø5/16" One-touch fitting	

Note) If an inch size cylinder port is selected, select inch size piping connections for the P and R ports as well.

④ Kit type

Kit type	Symbol	Specifications	Standard station	Max. number of stations for special wiring specifications	Max. number of solenoids
T kit	TD0	Terminal block box	1 to 10 stations	20 stations	20

Note) The maximum number of stations is determined by the total number of solenoids. For mixed single and double wirings, enter "-K" to the order code options.

Actuation type	Single	Double, Dual 3-port
Number of solenoids	1	2

⑤ Option

Symbol	Specifications
Nil	None
B ^{Note 2)}	With back pressure check valve (All stations)
D	With DIN rail (Rail length: Standard)
D0	Without DIN rail (With bracket)
D <input type="checkbox"/> ^{Note 3)}	With DIN rail Designated length (<input type="checkbox"/> : Station)
K ^{Note 4)}	Special wiring specifications (Except double wiring)
N	With name plate
R ^{Note 5)}	External pilot

Note 1) When two or more options are specified, indicate them alphabetically. Example) -BKN

Note 2) When installing a back pressure check valve on the required station, enter the part number and specify the station position on the manifold specification sheet.

Note 3) The available number of stations is larger than the number of manifold stations.

Note 4) Indicate the wiring specifications for mixed single and double wirings.

Note 5) For details, refer to page 481.

* For manifold optional parts, refer to pages 481 to 484.

* For manifold exploded view, refer to page 487.

How to Order Valve



Symbol	Specifications
1	2-position single
2	2-position double
A	4-position dual 3-port (N.C. + N.C.) [Exhaust center]
B	4-position dual 3-port (N.O. + N.O.) [Pressure center]
C	4-position dual 3-port (N.C. + N.O.)

Note) For symbol, refer to page 423.

Voltage

Symbol	Specifications
5	24 VDC
6	12 VDC

Function

Symbol	Specifications
Nil	Standard
R	External pilot ^{Note)}

Note) Not compatible with dual 3-port valves.

The 3(R) port is released to the atmosphere. (Pressurization and vacuum are not allowed.)

How to Order Manifold Assembly

Specify the part numbers for valves and options together beneath the manifold base part number.

<Example>

Terminal block box kit
 10-SS0750-08C4C8TD0 --1 set - Manifold base part no.
 * 10-S0710-53 sets - Valve part no. (Stations 1 to 3)
 * 10-S0720-52 sets - Valve part no. (Stations 4 to 5)
 * 10-S07A0-52 sets - Valve part no. (Stations 6 to 7)
 * SS0700-10A-11 set - Blanking plate part no. (Station 8)

Prefix the asterisk to the part no. of the solenoid valve, etc. Write sequentially from the 1st station on the D side. When part no. written collectively are complicated, specify on the manifold specification sheet.

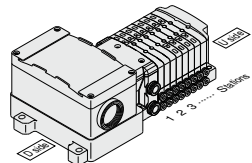

Base mounted plug-in •



Directional Control Valves
 Air Cylinders
 Rotary Actuators
 Air Grippers
 Air Preparation Equipment
 Modular F. R.
 Pressure Control Equipment
 Fittings & Tubing
 Flow Control Equipment
 Pressure Switches/ Pressure Sensors

T

Series 10-S0700 kit (Terminal Block Box)

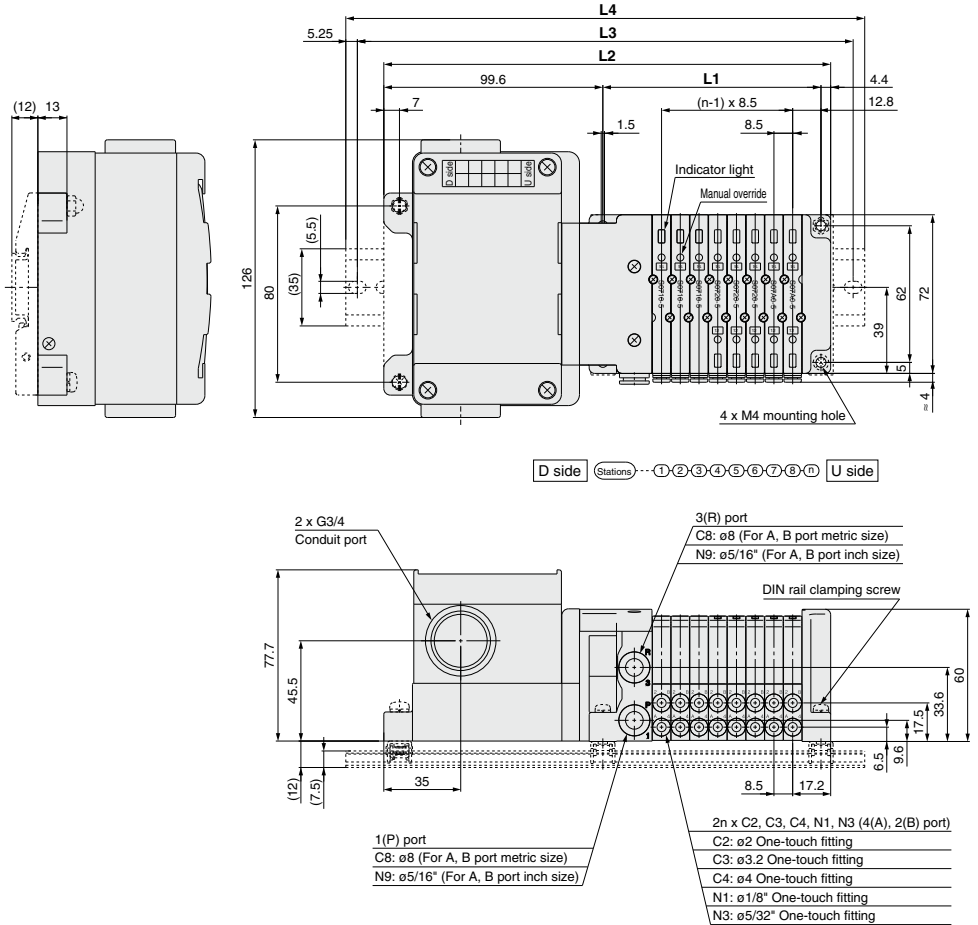

Dimensions

Formula L1 = 8.5n + 31, L2 = 8.5n + 135 n: Station (Maximum 20 stations)

L \ n	2	3	4	5	6	7	8	9	10	11	12	13	14	15	16	17	18	19	20
L1	48	56.5	65	73.5	82	90.5	99	107.5	116	124.5	133	141.5	150	158.5	167	175.5	184	192.5	201
L2	152	160.5	169	177.5	186	194.5	203	211.5	220	228.5	237	245.5	254	262.5	271	279.5	288	296.5	305
L3	175	187.5	200	212.5	225	237.5	250	262.5	275	287.5	297	305	312.5	320	327.5	335	342.5	350	357.5
L4	185.5	198	210.5	223	235.5	248	260.5	273	285.5	298	310.5	323	335.5	348	360.5	373	385.5	398	410.5

Plug-in Manifold Stacking Base

Lead Wire

L kit

Plug-in Manifold
Stacking Base

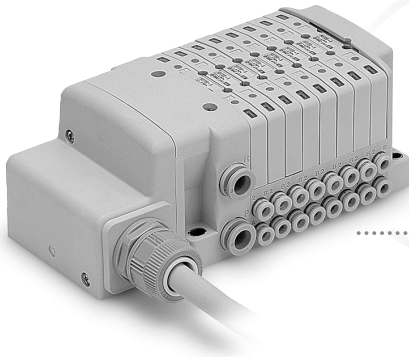

Lead Wire
Direct Entry
Type

Page 473



Directional
Control Valves

Air Cylinders

Rotary Actuators

Air Grippers

Air Preparation
Equipment

Modular F. R.

Pressure Control
Equipment

Fittings & Tubing

Flow Control
Equipment

Pressure Switches/
Pressure Sensors

L Series 10-S0700 Plug-in Manifold Stacking Base kit (Lead Wire)

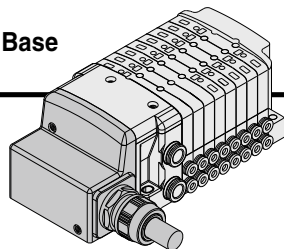

● Direct electrical entry type

Electrical Wiring Specifications

Lead wire specifications

Lead wire

0.3 mm² x 25 cores

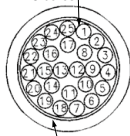

As the standard electrical wiring specifications, double wiring (connected to SOL.A and SOL.B) is adopted for the internal wiring of each station for 12 stations or less, regardless of valve and option types. Mixed single and double wiring is available as an option. For details, refer to "Special Wiring Specifications" (Option) below.

Lead wire length

SS0750 - 08 C4 LD 0

Lead wire length

0	0.6 m
1	1.5 m
2	3.0 m

Electrical Characteristics

Item	Property
Conductor resistance $\Omega/\text{km}, 20^\circ\text{C}$	65 or less
Voltage limit V, 1 minute, AC	1000
Insulation resistance $\text{M}\Omega/\text{km}, 20^\circ\text{C}$	5 or more

Note) Cannot be used for movable wiring. The minimum bending radius of cable is 20 mm.

	Terminal no.	Polarity	Lead wire color	Dot marking
Station 1	SOL.A 1	(-)	(+) Black	None
	SOL.B 14	(-)	(+) Yellow	Black
Station 2	SOL.A 2	(-)	(+) Brown	None
	SOL.B 15	(-)	(+) Pink	Black
Station 3	SOL.A 3	(-)	(+) Red	None
	SOL.B 16	(-)	(+) Blue	White
Station 4	SOL.A 4	(-)	(+) Orange	None
	SOL.B 17	(-)	(+) Purple	None
Station 5	SOL.A 5	(-)	(+) Yellow	None
	SOL.B 18	(-)	(+) Gray	None
Station 6	SOL.A 6	(-)	(+) Pink	None
	SOL.B 19	(-)	(+) Orange	Black
Station 7	SOL.A 7	(-)	(+) Blue	None
	SOL.B 20	(-)	(+) Red	White
Station 8	SOL.A 8	(-)	(+) Purple	White
	SOL.B 21	(-)	(+) Brown	White
Station 9	SOL.A 9	(-)	(+) Gray	Black
	SOL.B 22	(-)	(+) Pink	Red
Station 10	SOL.A 10	(-)	(+) White	Black
	SOL.B 23	(-)	(+) Gray	Red
Station 11	SOL.A 11	(-)	(+) White	Red
	SOL.B 24	(-)	(+) Black	White
Station 12	SOL.A 12	(-)	(+) Yellow	Red
	SOL.B 25	(-)	(+) White	None
	COM 13	(+)	(-) Orange	Red

Positive COM Negative COM

Note) Mounting valve has no polarity. It can also be used as a negative common.

Special Wiring Specifications (Option) [-K]

Mixed single and double wiring are available as an option. The maximum number of manifold stations is determined by the number of solenoids. Count one point for a single solenoid type and two points for a double solenoid type. The total number of solenoids (points) must not exceed 24.

1. How to Order valve

Indicate an option symbol, -K, for the manifold part number and be sure to specify the mounting position and number of stations of the single and double wiring on the manifold specification sheet.

2. Wiring specifications

Connector terminal numbers are connected from solenoid station 1 on the A side in the order indicated by the arrows without skipping any terminal numbers.



How to Order Manifold

10-SS0750-08 C4 C8 LD0-B

Clean series

Symbol	Stations
02	2 stations
⋮	⋮
24	24 stations

Note) The maximum number of stations will be different depending on the wiring specifications.

Cylinder port size

Symbol	Port size	
C2	With ø2 One-touch fitting	Metric
C3	With ø3.2 One-touch fitting	
C4	With ø4 One-touch fitting	
CM	Mixed sizes and with port plug ^{Note)}	Inch
N1	With ø1/8" One-touch fitting	
N3	With ø5/32" One-touch fitting	
NM	Mixed sizes and with port plug ^{Note)}	

Note) Specify "Mixed sizes and with port plug" on the manifold specification sheet.

P, R port size

Symbol	Port size	
C6	With ø6 One-touch fitting	Metric
C8	With ø8 One-touch fitting	
N7	With ø1/4" One-touch fitting	Inch
N9	With ø5/16" One-touch fitting	

Note) If an inch size cylinder port is selected, select inch size piping connections for the P and R ports as well.

Option

Symbol	Specifications
Nil	None
B ^{Note 2)}	With back pressure check valve (All stations)
D	With DIN rail (Rail length: Standard)
D0	Without DIN rail (With bracket)
D <input type="checkbox"/> ^{Note 3)}	With DIN rail Designated length (<input type="checkbox"/> : Station)
K ^{Note 4)}	Special wiring specifications (Except double wiring)
N	With name plate
R ^{Note 5)}	External pilot

- Note 1) When two or more options are specified, indicate them alphabetically. Example) -BKN
- Note 2) When installing a back pressure check valve on the required station, enter the part number and specify the station position on the manifold specification sheet.
- Note 3) The available number of stations is larger than the number of manifold stations.
- Note 4) Indicate the wiring specifications for mixed single and double wirings.
- Note 5) For details, refer to page 481.
 - * For manifold optional parts, refer to pages 481 to 484.
 - * For manifold exploded view, refer to page 487.

Kit type/Cable length

Kit type	Symbol	Specifications	Standard station	Max. number of stations for special wiring specifications	Max. number of solenoids
L kit	LD0	Lead wire, with 0.6 m cable	1 to 12 stations	24 stations	24
	LD1	Lead wire, with 1.5 m cable			
	LD2	Lead wire, with 3.0 m cable			

Note) The maximum number of stations is determined by the total number of solenoids. For mixed single and double wirings, enter "-K" to the order code options.

Actuation type	Single	Double, Dual 3-port
Number of solenoids	1	2

How to Order Valve

10-S07 1 0 - 5

Clean series

Actuation type

Symbol	Specifications
1	2-position single
2	2-position double
A	4-position dual 3-port (N.C. + N.C.) [Exhaust center]
B	4-position dual 3-port (N.O. + N.O.) [Pressure center]
C	4-position dual 3-port (N.C. + N.O.)

Note) For symbol, refer to page 423.

Voltage

Symbol	Specifications
5	24 VDC
6	12 VDC

Function

Symbol	Specifications
Nil	Standard
R	External pilot ^{Note)}

Note) Not compatible with dual 3-port valves. The 3(R) port is released to the atmosphere. (Pressurization and vacuum are not allowed.)

Base mounted plug-in

How to Order Manifold Assembly

Specify the order numbers for valves and options together beneath the manifold base part number.

<Example>

- Lead wire kit
 10-SS0750-08C4C8LD0---1 set - Manifold base part no.
 * 10-S0710-53 sets - Valve part no. (Stations 1 to 3)
 * 10-S0720-52 sets - Valve part no. (Stations 4 to 5)
 * 10-S07A0-52 sets - Valve part no. (Stations 6 to 7)
 * SS0700-10A-11 set - Blanking plate part no. (Station 8)

Prefix the asterisk to the part no. of the solenoid valve, etc.

Write sequentially from the 1st station on the D side. When part no. written collectively are complicated, specify on the manifold specification sheet.

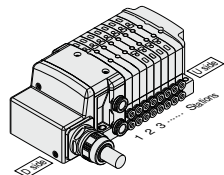

Directional Control Valves

Air Cylinders

Rotary Actuators

Air Grippers

Air Preparation Equipment

Modular F. R.

Pressure Control Equipment

Fittings & Tubing

Flow Control Equipment

Pressure Switches/Pressure Sensors

L Series 10-S0700 kit (Lead Wire)

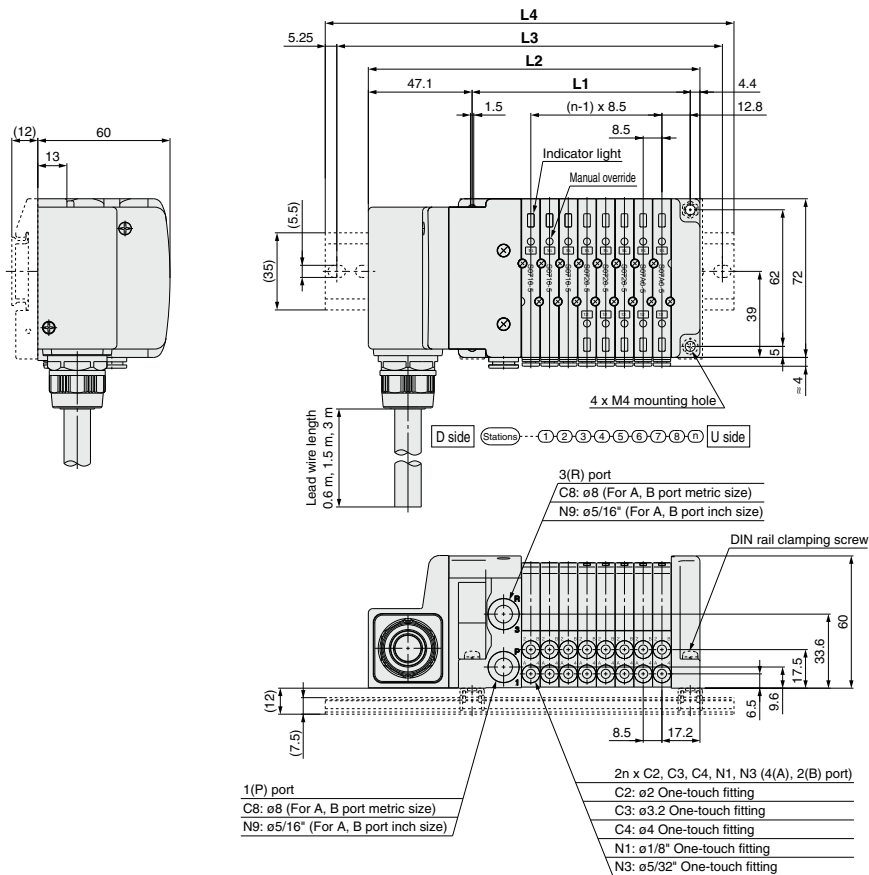

Dimensions

Formula L1 = 8.5n + 31, L2 = 8.5n + 82.5 n: Station (Maximum 24 stations)

L \ n	2	3	4	5	6	7	8	9	10	11	12	13	14	15	16	17	18	19	20	21	22	23	24
L1	48	56.5	65	73.5	82	90.5	99	107.5	116	124.5	133	141.5	150	158.5	167	175.5	184	192.5	201	209.5	218	226.5	235
L2	99.5	108	116.5	125	133.5	142	150.5	159	167.5	176	184.5	193	201.5	210	218.5	227	235.5	244	252.5	261	269.5	278	286.5
L3	125	137.5	137.5	150	162.5	162.5	175	187.5	187.5	200	212.5	212.5	225	237.5	250	250	262.5	275	275	287.5	300	300	312.5
L4	135.5	148	148	160.5	173	173	185.5	198	198	210.5	223	223	235.5	248	260.5	260.5	273	285.5	285.5	298	310.5	310.5	323

Plug-in Manifold Stacking Base

Circular Connector

M kit

Plug-in Manifold
Stacking Base



Circular
Connector
26 Pins

Page 477



Directional
Control Valves

Air Cylinders

Rotary Actuators

Air Grippers

Air Preparation
Equipment

Modular F. R.

Pressure Control
Equipment

Fittings & Tubing

Flow Control
Equipment

Pressure Switches/
Pressure Sensors

M Series 10-S0700 Plug-in Manifold Stacking Base kit (Circular Connector)

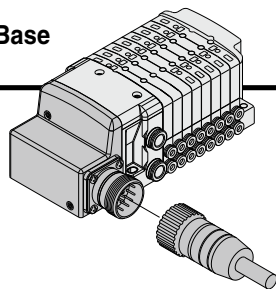

- Simplification and labor savings for wiring work can be achieved by using a circular connector for the electrical connection.

Electrical Wiring Specifications

Circular connector

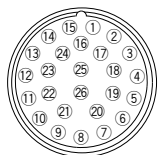

Double wiring (connected to SOL.A and SOL.B) is adopted for the internal wiring of each station, regardless of valve and option types.

Mixed single and double wiring is available as an option. For details, refer to "Special Wiring Specifications" (Option) below.

Terminal no.	Polarity	
Station 1	SOL.A 1 (-)	(+)
	SOL.B 2 (-)	(+)
Station 2	SOL.A 3 (-)	(+)
	SOL.B 4 (-)	(+)
Station 3	SOL.A 5 (-)	(+)
	SOL.B 6 (-)	(+)
Station 4	SOL.A 7 (-)	(+)
	SOL.B 8 (-)	(+)
Station 5	SOL.A 9 (-)	(+)
	SOL.B 10 (-)	(+)
Station 6	SOL.A 11 (-)	(+)
	SOL.B 12 (-)	(+)
Station 7	SOL.A 13 (-)	(+)
	SOL.B 14 (-)	(+)
Station 8	SOL.A 15 (-)	(+)
	SOL.B 16 (-)	(+)
Station 9	SOL.A 17 (-)	(+)
	SOL.B 18 (-)	(+)
Station 10	SOL.A 19 (-)	(+)
	SOL.B 20 (-)	(+)
Station 11	SOL.A 21 (-)	(+)
	SOL.B 22 (-)	(+)
	SOL.A 23 (-)	(+)
	SOL.B 24 (-)	(+)
	COM. 25 (+)	(-)
	COM. 26 (+)	(-)

Note) Mounting valve has no polarity. It can also be used as a negative common.

Special Wiring Specifications (Option) [-K]

Mixed single and double wiring are available as an option. The maximum number of manifold stations is determined by the number of solenoids. Count one point for a single solenoid type and two points for a double solenoid type. The total number of solenoids (points) must not exceed 24.

1. How to Order valve

Indicate an option symbol, -K, for the manifold part number and be sure to specify the mounting position and number of stations of the single and double wiring on the manifold specification sheet.

2. Wiring specifications

Connector terminal numbers are connected from solenoid station 1 on the A side in the order indicated by the arrows without skipping any terminal numbers.

Cable Assembly

AXT100-MC26-030
015
050

(Circular connector assembly (26P type) can be included in a specific manifold model number. Refer to "How to Order Manifold.")

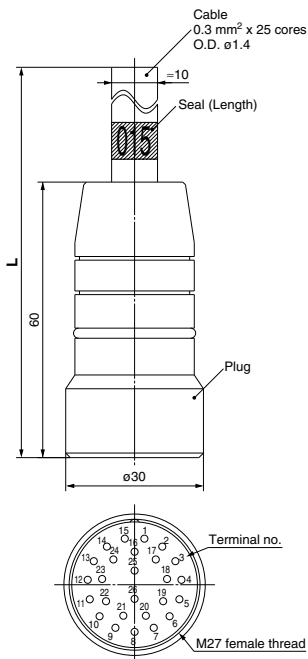

Circular Connector Cable Assembly (Option)

Cable length (L)	Assembly part no.
	26P
1.5 m	AXT100-MC26-015
3 m	AXT100-MC26-030
5 m	AXT100-MC26-050

* Cannot be used for movable wiring.



How to Order Manifold

10-SS0750-08 C4 C8 MD1-B

Clean series

① ② ③ ④ ⑤

① Stations

Symbol	Stations
02	2 stations
⋮	⋮
24 <small>Note</small>	24 stations

Note) The maximum number of stations will be different depending on the wiring specifications.

② Cylinder port size

Symbol	Port size	
C2	With ø2 One-touch fitting	Metric
C3	With ø3.2 One-touch fitting	
C4	With ø4 One-touch fitting	
CM	Mixed sizes and with port plug <small>Note</small>	
N1	With ø1/8" One-touch fitting	Inch
N3	With ø5/32" One-touch fitting	
NM	Mixed sizes and with port plug <small>Note</small>	

Note) Specify "Mixed sizes and with port plug" on the manifold specification sheet.

③ P, R port size

Symbol	Port size	
C6	With ø6 One-touch fitting	Metric
C8	With ø8 One-touch fitting	
N7	With ø1/4" One-touch fitting	Inch
N9	With ø5/16" One-touch fitting	

Note) If an inch size cylinder port is selected, select inch size piping connections for the P and R ports as well.

④ Kit type/Cable length

Kit type	Symbol	Specifications	Standard station	Max. number of stations for special wiring specifications	Max. number of solenoids
M kit	MD0	Circular connector (26P), without cable	1 to 12 stations	24 stations	24
	MD1	Circular connector (26P), with 1.5 m cable			
	MD2	Circular connector (26P), with 3.0 m cable			
	MD3	Circular connector (26P), with 5.0 m cable			

Note) The maximum number of stations is determined by the total number of solenoids. For mixed single and double wirings, enter "K" to the order code options.

Actuation type	Single	Double, Dual 3-port
Number of solenoids	1	2

How to Order Valve

10-S07 1 0 - 5

Clean series

Actuation type

Symbol	Specifications
1	2-position single
2	2-position double
A	4-position dual 3-port (N.C. + N.C.) [Exhaust center]
B	4-position dual 3-port (N.O. + N.O.) [Pressure center]
C	4-position dual 3-port (N.C. + N.O.)

Note) For symbol, refer to page 423.

Base mounted plug-in

Voltage

Symbol	Specifications
5	24 VDC
6	12 VDC

Function

Symbol	Specifications
NH	Standard
R	External pilot <small>Note</small>

Note) Not compatible with dual 3-port valves. The 3(R) port is released to the atmosphere. (Pressurization and vacuum are not allowed.)

⑤ Option

Symbol	Specifications
NH	None
B <small>Note 2</small>	With back pressure check valve (All stations)
D	With DIN rail (Rail length: Standard)
D0	Without DIN rail (With bracket)
D <small>Note 3</small>	With DIN rail Designated length (□: Station)
K <small>Note 4</small>	Special wiring specifications (Except double wiring)
N	With name plate
R <small>Note 5</small>	External pilot

Note 1) When two or more options are specified, indicate them alphabetically.

Example) -BKN

Note 2) When installing a back pressure check valve on the required station, enter the part number and specify the station position on the manifold specification sheet.

Note 3) The available number of stations is larger than the number of manifold stations.

Note 4) Indicate the wiring specifications for mixed single and double wirings.

Note 5) For details, refer to page 481.

• For manifold optional parts, refer to pages 481 to 484.

• For manifold exploded view, refer to page 487.

How to Order Manifold Assembly

Specify the part numbers for valves and options together beneath the manifold base part number.

<Example>

Circular connector kit

10-SS0750-08C4C8MD1... 1 set - Manifold base part no.
 * 10-S0710-5 3 sets - Valve part no. (Stations 1 to 3)
 * 10-S0720-5 2 sets - Valve part no. (Stations 4 to 5)
 * 10-S07A0-5 2 sets - Valve part no. (Stations 6 to 7)
 * SS0700-10A-1 1 set - Blanking plate part no. (Station 8)

Prefix the asterisk to the part no. of the solenoid valve, etc.

Write sequentially from the 1st station on the D side. When part no. written collectively are complicated, specify on the manifold specification sheet.

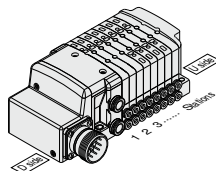

Directional Control Valves

Air Cylinders

Rotary Actuators

Air Grippers

Air Preparation Equipment

Modular F. R.

Pressure Control Equipment

Fittings & Tubing

Flow Control Equipment

Pressure Switches/ Pressure Sensors

M Series 10-S0700 kit (Circular Connector)

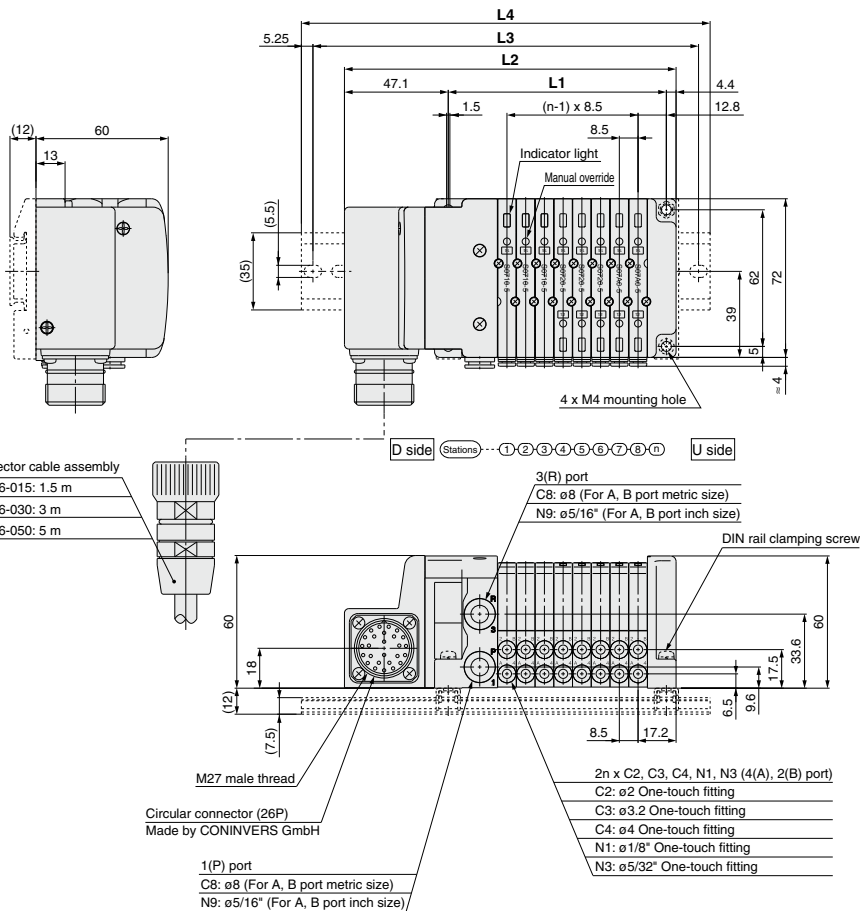

Dimensions

Formula L1 = 8.5n + 31, L2 = 8.5n + 82.5 n: Station (Maximum 24 stations)

L \ n	2	3	4	5	6	7	8	9	10	11	12	13	14	15	16	17	18	19	20	21	22	23	24
L1	48	56.5	65	73.5	82	90.5	99	107.5	116	124.5	133	141.5	150	158.5	167	175.5	184	192.5	201	209.5	218	226.5	235
L2	99.5	108	116.5	125	133.5	142	150.5	159	167.5	176	184.5	193	201.5	210	218.5	227	235.5	244	252.5	261	269.5	278	286.5
L3	125	137.5	137.5	150	162.5	162.5	175	187.5	187.5	200	212.5	212.5	225	237.5	250	250	262.5	275	275	287.5	300	300	312.5
L4	135.5	148	148	160.5	173	173	185.5	198	198	210.5	223	223	235.5	248	260.5	260.5	273	285.5	285.5	298	310.5	310.5	323

Series 10-S0700 Plug-in Manifold Stacking Base

Manifold Optional Parts

Blanking plate

SS0700-10A-1

It is used by attaching on the manifold block for being prepared for removing a valve for maintenance reasons or planning to mount a spare valve, etc.

Weight: 25 g

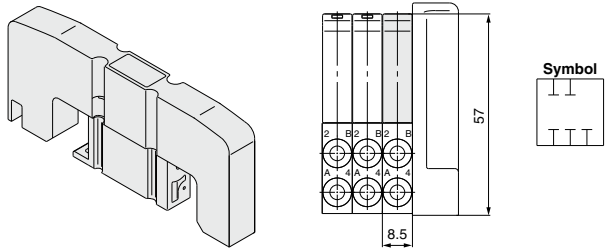

External pilot [-R]

This can be used when the air pressure is 0.1 to 0.2 MPa lower than the minimum operating pressure of the solenoid valves or used for vacuum specifications.

Add R to the part numbers of manifolds and valves to indicate the external pilot specifications.

An M5 port will be installed on the top side of the manifold's SUP/EXH block.

● How to Order Valve (Example)

10-S0710 R -5

↓ External pilot

● How to Order Manifold (Example)

* Indicate R for an option.

10-SS0750-08C4FD1-R

↓ External pilot

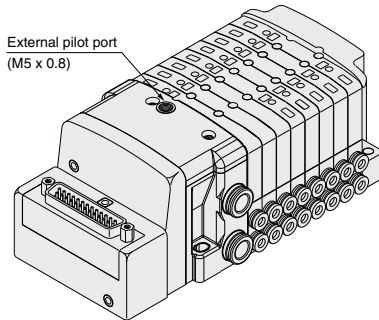

- Note 1) Not compatible with dual 3-port valves.
- Note 2) When the internal pilot type and external pilot type of valves are mixed up on the manifold, order the manifold suitable for the specifications of the external pilot valve.
- Note 3) Since the pilot EXH of valves with the external pilot specification also has a common exhaust specification, the 3(R) port should be released to the atmosphere.

Individual SUP/EXH spacer

SS0700-PR-1

If this spacer is installed instead of a valve, it is possible to add SUP and EXH ports. In this condition, the A port should be an SUP port and the B port an EXH port.

* Specify the spacer mounting position and SUP/EXH passage shut off positions on the manifold specification sheet.

* The spacer comes with a SUP block plate and an EXH block plate.

* Electrical wiring is also connected to the spacer mounting position.

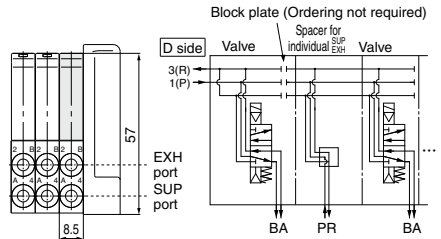
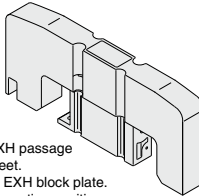

SUP block plate

SS0700-B-P

When different pressures, high and low, are supplied to one manifold, a SUP block plate is inserted between the stations under different pressures.

- * Specify the number of stations on the manifold specification sheet.

<Block indication label>

When using block plates for SUP passage, indication label for confirmation of the blocking position from outside is attached. (One label of each)

- * When ordering a block plate for SUP incorporated with the manifold, a block indication label is attached to the manifold.

Weight: 0.3 g

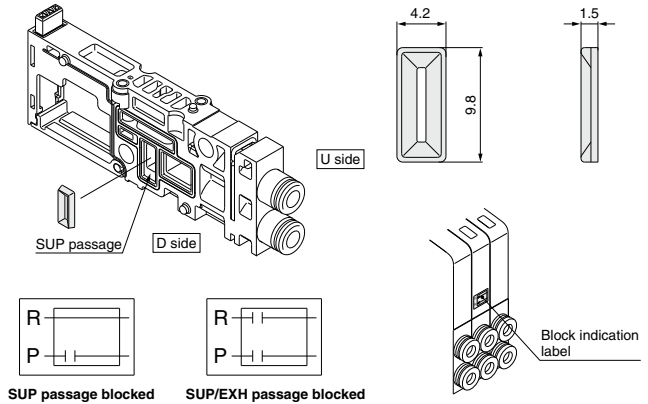

EXH block plate

SS0700-B-R

When valve exhaust affects the other stations on the circuit, insert EXH block plate in between stations to separate valve exhaust.

- * Specify the number of stations on the manifold specification sheet.

<Block indication label>

When using block plates for EXH passage, indication label for confirmation of the blocking position from outside is attached. (One label of each)

- * When ordering a block plate for EXH incorporated with the manifold, a block indication label is attached to the manifold.

Weight: 0.3 g

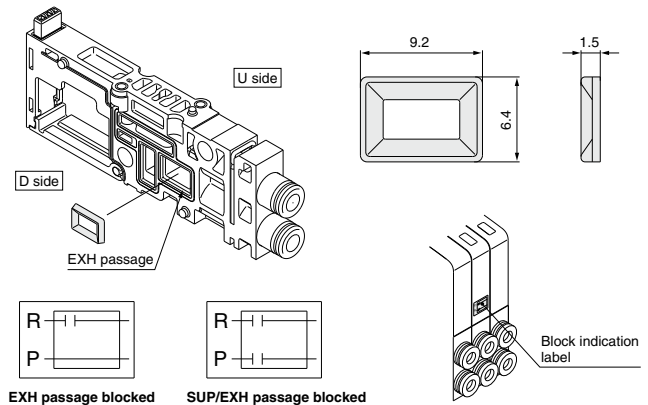

Back pressure check valve [-B]

SS0700-7A-1

It prevents cylinder malfunction caused by other valve exhaust. Insert it into R (EXH) port on the manifold side of a valve which is affected. It is effective when a single action cylinder is used or an exhaust center type solenoid valve is used.

- * When a check valve for back pressure prevention is desired, and is to be installed only in certain manifold stations, clearly write the part number and specify the number of stations on the manifold specification sheet.
- * When ordering this option incorporated with a manifold, suffix "-B" to the end of the manifold part number.

Weight: 0.1 g

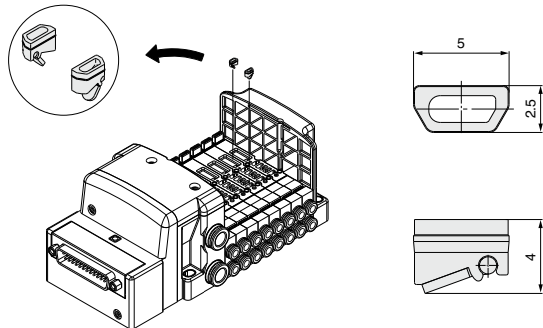

⚠ Precautions

1. The back pressure check valve assembly is assembly parts with a check valve structure. However, as slight air leakage is allowed for the back pressure, take care the exhaust air will not be restricted at the exhaust port.
2. When a back pressure check valve is mounted, the effective area of the valve will decrease by about 20%.

Directional Control Valves
Air Cylinders
Rotary Actuators
Air Grippers
Air Preparation Equipment
Modular F. R.
Pressure Control Equipment
Fittings & Tubing
Flow Control Equipment
Pressure Switches/Pressure Sensors

Series 10-S0700 Plug-in Manifold Stacking Base

Manifold Optional Parts

Blanking plate with output

SS0700-1C-□

Lead wire length (mm)

Nil	600
10	1000
15	1500
20	2000
25	2500
30	3000

Symbol



Blanking plate with a connector for individually outputting electricity to drive a single valve or equipment that are not on the manifold base.

Note 1) Electric current should be 0.5 A or less.

(Including the mounted valves) When the current is output from two positions at the same time, the current should be 0.25 A or less.

Note 2) Please consult with SMC for the max. allowable current for serial transmission kit.

Weight: 34 g

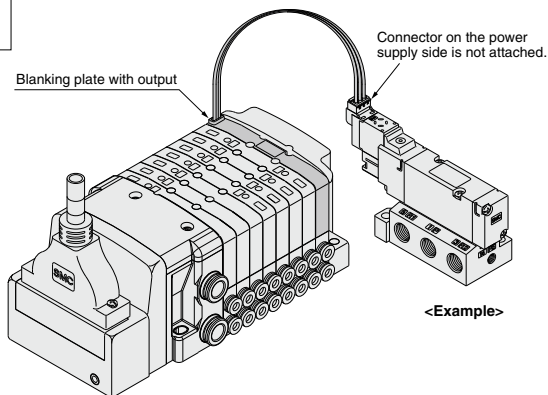

<Example>

Port plug

VVQ0000-CP

The plug is used to block the cylinder port when using a 5-port valve as a 3-port valve.

* When ordering a plug incorporated with a manifold, indicate "CM" for the port size in the manifold part number, as well as, the mounting position and number of stations and cylinder port mounting positions, A and B on the manifold specification sheet.

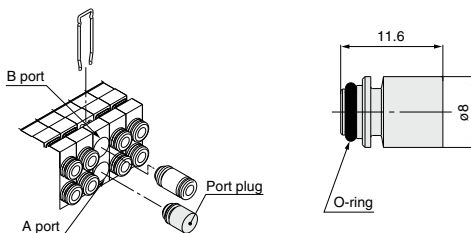

DIN rail mounting bracket

SS0700-57A-□

Symbol	Specifications
Nil	S (EX500), F, P, L M kit
S	S (EX250) kit
T	T kit

It is used for mounting a manifold on a DIN rail. The DIN rail mounted bracket is fixed to the manifold end plate. (The specification is the same as that for the option "-D".)

1 set of DIN rail mounting bracket is included for 1 manifold (2 or 3 DIN rail mounting brackets (S, T kit)).

* When ordering this option incorporated with a manifold, suffix "-D" to the end of the manifold part number.

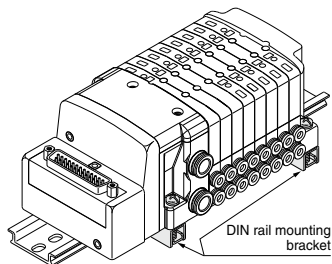

Blanking plug (For One-touch fittings)

KJP-02

23
KQ2P-04
06

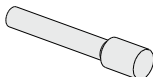

It is inserted into an unused cylinder port and SUP/EXH ports. Purchasing order is available in units of 10 pieces.

483

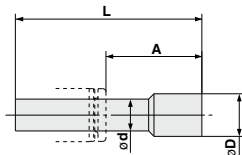

Dimensions

Applicable fitting size	Model	A	L	D	Weight: g
2	KJP-02	8.2	17	3	0.1
3.2	KQ2P-23	16	31.5	3.2	1
4	KQ2P-04	16	32	6	1
6	KQ2P-06	18	35	8	1

Applicable to DIN rail mounting

Each manifold can be mounted on a DIN rail.
 Order it by indicating a manifold mounting symbol for DIN rail mounting [-D].
 Standard DIN rail which is approx. 30 mm longer than the manifold with the specified number of stations is attached.
 The following options are also available.

● **DIN rail length longer than the standard (for stations to be added later, etc.)**

In the manifold part number, specify -D for the manifold mounting symbol and add the number of required stations after the symbol.

Example) **10-SS0750-08C4FD0-D09K**



● **How to Order DIN rail only**

DIN rail part number

AXT100-DR-n

Note) For n, enter a number from the No. line in the table below. For L dimension, refer to the dimensions of each kit.

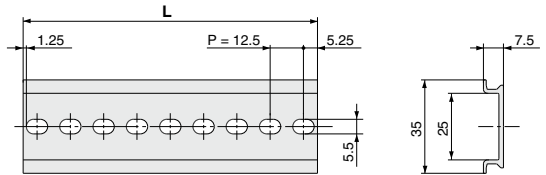

L Dimension

$L = 12.5 \times n + 10.5$

No.	1	2	3	4	5	6	7	8	9	10
L dimension	23	35.5	48	60.5	73	85.5	98	110.5	123	135.5
No.	11	12	13	14	15	16	17	18	19	20
L dimension	148	160.5	173	185.5	198	210.5	223	235.5	248	260.5
No.	21	22	23	24	25	26	27	28	29	30
L dimension	273	285.5	298	310.5	323	335.5	348	360.5	373	385.5
No.	31	32	33	34	35	36	37	38	39	40
L dimension	398	410.5	423	435.5	448	460.5	473	485.5	498	510.5

Name plate [-N]

SS0700-N-Station (1 to max. stations)

It is a transparent resin plate for placing a label that indicates solenoid valve function, etc. Insert it into the groove on the side of the end plate and bend it as shown in the figure.

* When ordering this option incorporated with a manifold, suffix "-N" to the end of the manifold part number.

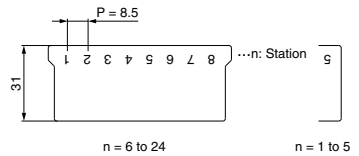
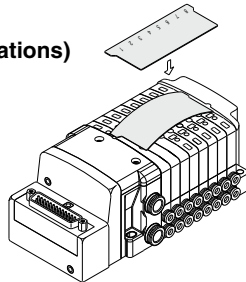

Directional Control Valves

Air Cylinders

Rotary Actuators

Air Grippers

Air Preparation Equipment

Modular F. R.

Pressure Control Equipment

Fittings & Tubing

Flow Control Equipment

Pressure Switches/ Pressure Sensors

Series 10-S0700 Plug-in Manifold Stacking Base Construction

Single: 10-S0710

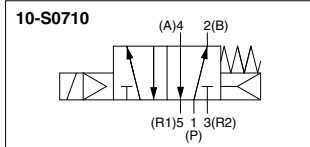
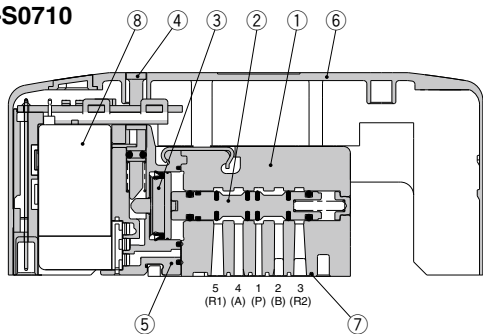

Double: 10-S0720

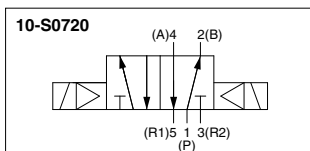
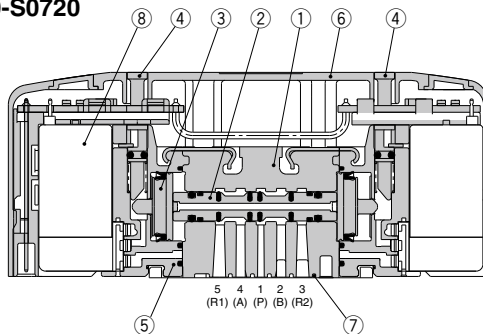

Dual 3-Port: 10-S07B0

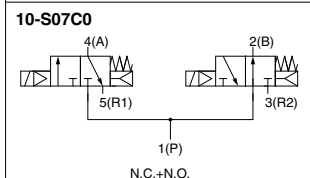
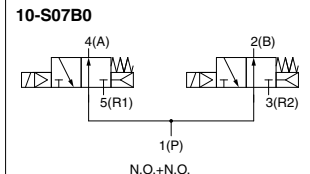
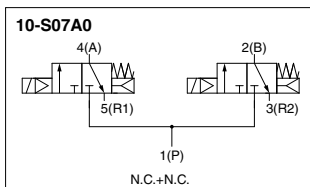
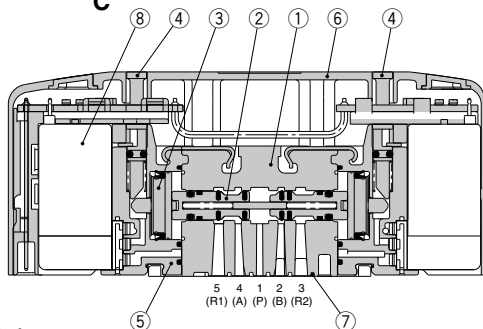

Component Parts

No.	Description	Material
1	Body	Zinc die-casted
2	Spool	Aluminum
3	Piston	Resin
4	Manual override	Resin
5	Adapter plate	Resin
6	Cover	Resin
7	Interface gasket	HNBR
8	Pilot valve assembly ^(Note)	—

Note) Please consult with SMC for pilot valve replacement.

Series 10-S0700/Plug-in Manifold

Manifold Exploded View

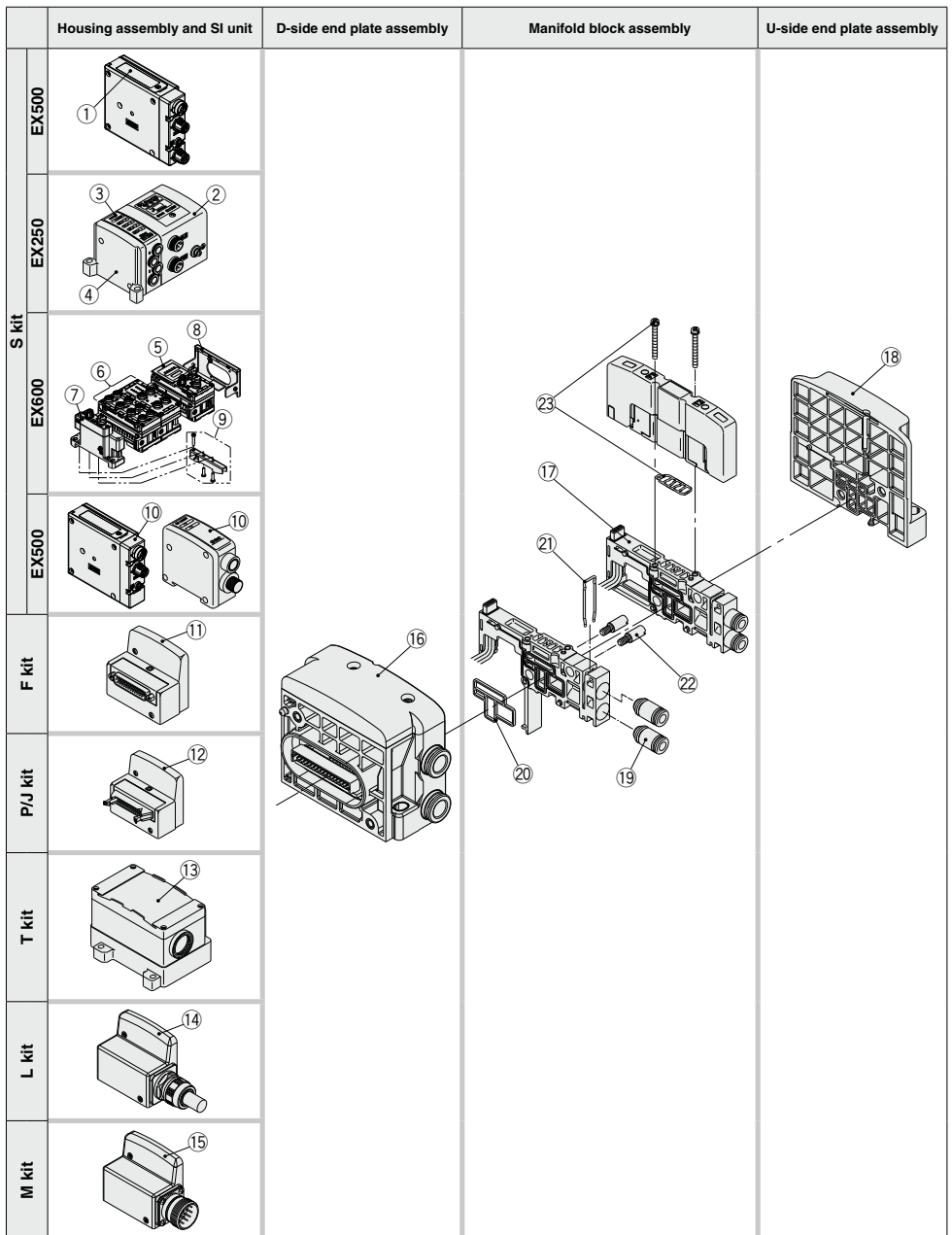

The 1-port EtherNet/IP compatible SI unit is to be discontinued as of March 2022.
Please consider ordering the 2-port EtherNet/IP compatible SI unit as a substitute.

Discontinued models	Substitute models
EX600-SEN1	▶ EX600-SEN3
EX600-SEN2	▶ EX600-SEN4

Manifold Assembly Part No.

<Housing Assembly and SI Unit, Input Block>

No.	Description	Part no.	Note		
①	EX260 SI unit	EX260-SDN1	DeviceNet® M12 connector, 32 outputs, PNP (Negative common)		
		EX260-SDN2	DeviceNet® M12 connector, 32 outputs, NPN (Positive common)		
		EX260-SDN3	DeviceNet® M12 connector, 16 outputs, PNP (Negative common)		
		EX260-SDN4	DeviceNet® M12 connector, 16 outputs, NPN (Positive common)		
		EX260-SPR1	PROFIBUS DP M12 connector, 32 outputs, PNP (Negative common)		
		EX260-SPR2	PROFIBUS DP M12 connector, 32 outputs, NPN (Positive common)		
		EX260-SPR3	PROFIBUS DP M12 connector, 16 outputs, PNP (Negative common)		
		EX260-SPR4	PROFIBUS DP M12 connector, 16 outputs, NPN (Positive common)		
		EX260-SPR5	PROFIBUS DP D-sub connector, 32 outputs, PNP (Negative common)		
		EX260-SPR6	PROFIBUS DP D-sub connector, 32 outputs, NPN (Positive common)		
		EX260-SPR7	PROFIBUS DP D-sub connector, 16 outputs, PNP (Negative common)		
		EX260-SPR8	PROFIBUS DP D-sub connector, 16 outputs, NPN (Positive common)		
		EX260-SMJ1	CC-Link M12 connector, 32 outputs, PNP (Negative common)		
		EX260-SMJ2	CC-Link M12 connector, 32 outputs, NPN (Positive common)		
		EX260-SMJ3	CC-Link M12 connector, 16 outputs, PNP (Negative common)		
		EX260-SMJ4	CC-Link M12 connector, 16 outputs, NPN (Positive common)		
		EX260-SEC1	EtherCAT M12 connector, 32 outputs, PNP (Negative common)		
		EX260-SEC2	EtherCAT M12 connector, 32 outputs, NPN (Positive common)		
		EX260-SEC3	EtherCAT M12 connector, 16 outputs, PNP (Negative common)		
		EX260-SEC4	EtherCAT M12 connector, 16 outputs, NPN (Positive common)		
		EX260-SPN1	PROFINET M12 connector, 32 outputs, PNP (Negative common)		
		EX260-SPN2	PROFINET M12 connector, 32 outputs, NPN (Positive common)		
		EX260-SPN3	PROFINET M12 connector, 16 outputs, PNP (Negative common)		
		EX260-SPN4	PROFINET M12 connector, 16 outputs, NPN (Positive common)		
		EX260-SEN1	EtherNet/IP™ M12 connector, 32 outputs, PNP (Negative common)		
		EX260-SEN2	EtherNet/IP™ M12 connector, 32 outputs, NPN (Positive common)		
		EX260-SE3	EtherNet/IP™ M12 connector, 16 outputs, PNP (Negative common)		
		EX260-SE4	EtherNet/IP™ M12 connector, 16 outputs, NPN (Positive common)		
		②	EX250 SI unit	EX250-SDN1	DeviceNet® PNP (Negative common)
				EX250-SPR1	PROFIBUS DP PNP (Negative common)
				EX250-SAS3	AS-Interface 31 slave, 8 in/8 out, 2 isolated common type, PNP (Negative common)
				EX250-SAS5	AS-Interface 31 slave, 4 in/4 out, 2 isolated common type, PNP (Negative common)
EX250-SAS7	AS-Interface 31 slave, 8 in/4 out, 1 common type, PNP (Negative common)				
EX250-SAS9	AS-Interface 31 slave, 4 in/4 out, 1 common type, PNP (Negative common)				
EX250-SCA1A	CANopen PNP (Negative common)				
EX250-SEN1	EtherNet/IP™ PNP (Negative common)				
③	EX250 input block			EX250-IE1	M12 2 inputs
		EX250-IE2	M12 4 inputs		
		EX250-IE3	M8 4 inputs		
④	EX250 end plate assembly	EX250-EA1	Direct mounting		
		EX250-EA2	DIN rail mounting		
⑤	EX600 SI unit	EX600-SDN1A	DeviceNet® PNP (Negative common)		
		EX600-SDN2A	DeviceNet® NPN (Positive common)		
		EX600-SMJ1	CC-Link PNP (Negative common)		
		EX600-SMJ2	CC-Link NPN (Positive common)		
		EX600-SPR1A	PROFIBUS DP PNP (Negative common)		
		EX600-SPR2A	PROFIBUS DP NPN (Positive common)		
		EX600-SEN1	EtherNet/IP™ (1 port) PNP (Negative common)		
		EX600-SEN2	EtherNet/IP™ (1 port) NPN (Positive common)		
		EX600-SEN3	EtherNet/IP™ (2 ports) PNP (Negative common)		
		EX600-SEN4	EtherNet/IP™ (2 ports) NPN (Positive common)		
		EX600-SPN1	PROFINET PNP (Negative common)		
		EX600-SPN2	PROFINET NPN (Positive common)		
		EX600-SEC1	EtherCAT PNP (Negative common)		
		EX600-SEC2	EtherCAT NPN (Positive common)		
		EX600-WEN1 ^(Note)	Wireless base module EtherNet/IP™ PNP (Negative common)		
		EX600-WEN2 ^(Note)	Wireless base module EtherNet/IP™ NPN (Positive common)		
		EX600-WPN1 ^(Note)	Wireless base module PROFINET PNP (Negative common)		
		EX600-WPN2 ^(Note)	Wireless base module PROFINET NPN (Positive common)		
		EX600-WSV1 ^(Note)	Wireless remote module PNP (Negative common)		
		EX600-WSV2 ^(Note)	Wireless remote module NPN (Positive common)		
		⑥	EX600 digital input unit	EX600-DXNB	NPN input, M12 connector, 5 pins (4 pcs.), 8 inputs
				EX600-DXPB	PNP input, M12 connector, 5 pins (4 pcs.), 8 inputs
				EX600-DXNC	NPN input, M8 connector, 3 pins (8 pcs.), 8 inputs
				EX600-DXNC1	NPN input, M8 connector, 3 pins (8 pcs.), 8 inputs, with open circuit detection
EX600-DXPC	PNP input, M8 connector, 3 pins (8 pcs.), 8 inputs				
EX600-DXPC1	PNP input, M8 connector, 3 pins (8 pcs.), 8 inputs, with open circuit detection				
EX600-DXND	NPN input, M12 connector, 5 pins (8 pcs.), 16 inputs				
EX600-DXPD	PNP input, M12 connector, 5 pins (8 pcs.), 16 inputs				
EX600-DXNE	NPN input, D-sub connector, 25 pins, 16 inputs				
EX600-DXPE	PNP input, D-sub connector, 25 pins, 16 inputs				
EX600-DXNF	NPN input, Spring type terminal block, 32 pins, 16 inputs				
EX600-DXPF	PNP input, Spring type terminal block, 32 pins, 16 inputs				

(Note) The wireless system is suitable for use only in a country where it is in accordance with the Radio Act and regulations of that country.



Directional Control Valves

Air Cylinders

Rotary Actuators

Air Grippers

Air Preparation Equipment

Modular F. R.

Pressure Control Equipment

Fittings & Tubing

Flow Control Equipment

Pressure Switches/Pressure Sensors

Manifold Assembly Part No.

<Housing Assembly and SI Unit, Input Block>

No.	Description	Part no.	Note
⑥	EX600 digital output unit	EX600-DYNB	NPN output, M12 connector, 5 pins (4 pcs.), 8 outputs
		EX600-DYPB	PNP output, M12 connector, 5 pins (4 pcs.), 8 outputs
		EX600-DYNE	NPN output, D-sub connector, 25 pins, 16 outputs
		EX600-DYPE	PNP output, D-sub connector, 25 pins, 16 outputs
		EX600-DYNF	NPN output, Spring type terminal block, 32 pins, 16 outputs
	EX600 digital I/O unit	EX600-DYPE	PNP output, Spring type terminal block, 32 pins, 16 outputs
		EX600-DMNE	NPN input/output, D-sub connector, 25 pins, 8 inputs/outputs
		EX600-DMPE	PNP input/output, D-sub connector, 25 pins, 8 inputs/outputs
		EX600-DMNF	NPN input/output, Spring type terminal block, 32 pins, 8 inputs/outputs
		EX600-DMPF	PNP input/output, Spring type terminal block, 32 pins, 8 inputs/outputs
⑦	EX600 analog input unit	EX600-AXA	M12 connector, 5 pins (2 pcs.), 2-channel input
	EX600 analog output unit	EX600-AYA	M12 connector, 5 pins (2 pcs.), 2-channel output
	EX600 analog I/O unit	EX600-AMB	M12 connector, 5 pins (4 pcs.), 2-channel input/output
	EX600 end plate	EX600-ED2	M12 connector, 5 pins
		EX600-ED2-2	M12 connector, 5 pins, with DIN rail mounting bracket
		EX600-ED3	7/8 inch connector, 5 pins
		EX600-ED3-2	7/8 inch connector, 5 pins, with DIN rail mounting bracket
		EX600-ED4	M12 connector (4 pins/5 pins) IN/OUT
		EX600-ED4-2	M12 connector (4 pins/5 pins) IN/OUT, with DIN rail mounting bracket
		EX600-ED5	M12 connector (4 pins/5 pins) IN/OUT
EX600-ED5-2		M12 connector (4 pins/5 pins) IN/OUT, with DIN rail mounting bracket	
⑧	EX600 valve plate	EX600-ZMV1	Enclosed parts: Round head screw (M4 x 6) 2 pcs. Round head screw (M3 x 8) 4 pcs.
⑨	EX600 bracket for end plate	EX600-ZMA2	This bracket is used for the end plate of DIN rail mounting.
⑩	EX500 SI unit	EX500-S103	EX500 Gateway Decentralized System 2 Negative common (PNP)
		EX500-Q001	EX500 Gateway Decentralized System Positive common (NPN)
		EX500-Q101	EX500 Gateway Decentralized System Negative common (PNP)
⑪	D-sub connector housing assembly	VVQC1000-F25-1	F kit, 25 pins
		VVQC1000-P26-1	P kit, 26 pins
		VVQC1000-P20-1	P kit, 20 pins
⑫	Flat ribbon cable housing assembly	VVQC1000-J20-1	J kit, 20 pins
⑬	Terminal block box housing assembly	VVQC1000-T0-1	T kit
⑭	Lead wire housing assembly	VVQC1000-L25-0-1	L kit, Lead wire length 0.6 m
		VVQC1000-L25-1-1	L kit, Lead wire length 1.5 m
		VVQC1000-L25-2-1	L kit, Lead wire length 3.0 m
⑮	Circular connector housing assembly	VVQC1000-M26-1	M kit, 26 pins

⑮ D-side end plate assembly part no.

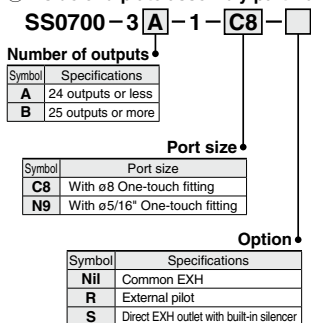

⑰ Manifold block assembly

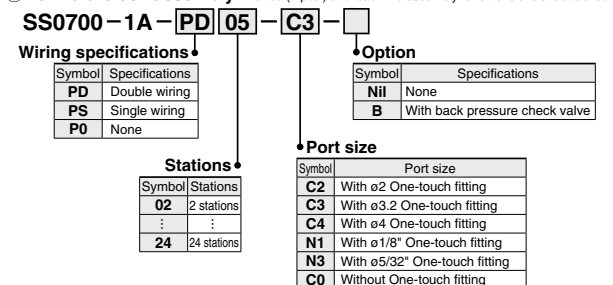

⑱ U-side end plate assembly part no.

SS0700-2A-2

⑲ Fitting assembly part no.

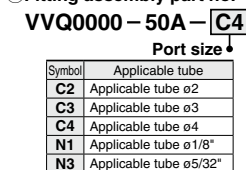

<Replacement Parts for Manifold Block>

No.	Description	Part no.	Qty.
⑳	Gasket	SS0700-80A-2	10 ¹
㉑	Clip	SS0700-80A-4	10 ¹
㉒	Tie-rod assembly	SS0700-TR-□	2 ²

- *1: 1 set includes 10 pieces.
 *2: 1 set includes 2 pieces. Please order when eliminating manifold stations. When adding stations, tie-rods are attached to the manifold block assembly. Therefore, it is not necessary to order.
 □: Stations 02 to 24

<Replacement Parts for Valve>

No.	Description	Part no.	Qty.
㉓	Gasket, Screw	S0700-GS-5	10

- *: Above part number consists of 10 units. Each unit has one gasket and two screws.

How to Add Manifold Stations (Plug-in Type / Lead Wire Connection Type)

What to order

- Manifold block assembly (Refer to page 489-16.)

Steps for adding stations

- ① Loosen hexagon bolts from the end plate at the U-side and remove the end plate.
- ② Connect the tie-rod for increasing the station number, open the junction cover, mount the manifold block assembly and U-side end plate and tighten them by hexagon bolts. (Tightening torque: 0.85 to 0.95 N·m)
- ③ Connect the round type terminal of red lead wire to the common terminal inside the junction cover.

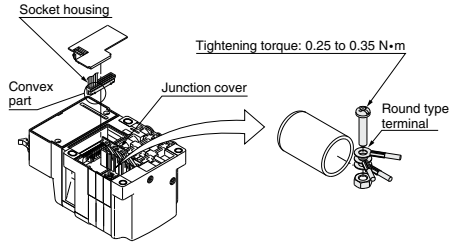
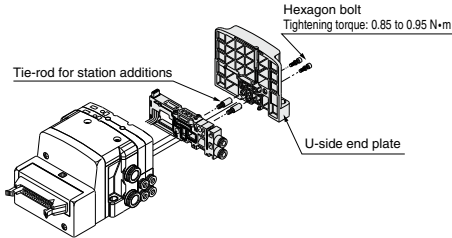

- ④ Take out the socket housing and connect the black and white lead wires. The connection layout is common to all kits.

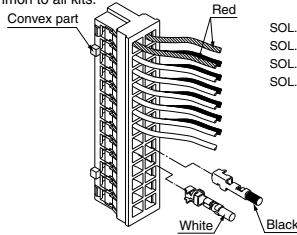

		Terminal no.			
COM.	Red	1A	1B	Red	COM.
SOL.A Station 2	Black	2A	2B	Black	Station 1 SOL.A
SOL.B Station 3	White	3A	3B	Black	Station 3 SOL.A
SOL.B Station 4	White	4A	4B	Black	Station 4 SOL.A
SOL.B Station 5	White	5A	5B	Black	Station 5 SOL.A
		6A	6B	Black	Station 6 SOL.A
		7A	7B		
		8A	8B		
		9A	9B		
		10A	10B		
		11A	11B		
		12A	12B		
		13A	13B		

Plug Lead Manifold Bar Base

Connector

C kit



**Plug-in Manifold
Bar Base**

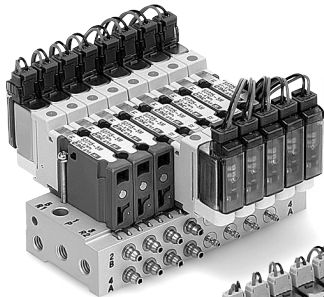

With barb fittings

**Individual
Connector**

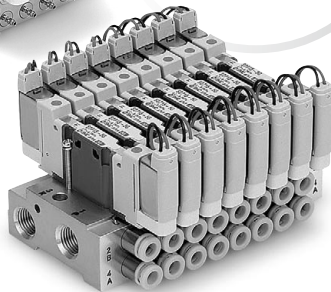

With One-touch fittings

→ **Page 491**

Directional
Control Valves

Air Cylinders

Rotary Actuators

Air Grippers

Air Preparation
Equipment

Modular F. R.

Pressure Control
Equipment

Fittings & Tubing

Flow Control
Equipment

Pressure Switches/
Pressure Sensors



Series 10-S0700 Plug Lead Manifold Bar Base kit (Connector)

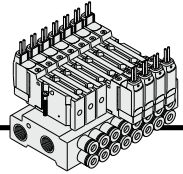

How to Order Manifold

10-SS0755-08C4 C -

Clean series

Plug lead

Stations

Symbol	Stations
02	2 stations
⋮	⋮
20	20 stations

Cylinder port size

Symbol	Port size	Manifold pitch
M5	M5 thread	Metric
C2	With ø2 One-touch fitting	
C3	With ø3.2 One-touch fitting	
C4	With ø4 One-touch fitting	
CM	Mixed sizes and with port plug ^{Note)}	Inch
N1	With ø1/8" One-touch fitting	
N3	With ø5/32" One-touch fitting	
NM	Mixed sizes and with port plug ^{Note)}	

Note) Specify "Mixed sizes and with port plug" on the manifold specification sheet.
* The manifold pitch 7.5 mm type is available as special order.

Option

Symbol	Specifications
Nil	None
R ^{Note)}	External pilot

Note) For details, refer to page 497.
* For manifold optional parts, refer to pages 497 to 498.

Connector kit

P, R port thread type

Symbol	Manifold pitch	
	8.5	7.5
Nil	Rc (PT)	M5
F	G (PF)	
N	NPT	
T	NPTF	

How to Order Valve

10-S07 1 5 - 5 G

Clean series

Actuation type

Symbol	Specifications
1	2-position single
2	2-position double
A	4-position dual 3-port (N.C. + N.C.) [exhaust center]
B	4-position dual 3-port (N.O. + N.O.) [pressure center]
C	4-position dual 3-port (N.C. + N.O.)

Note) For symbol, refer to page 423.

Base mounted plug lead

Electrical entry

Symbol	Specifications
G	Grommet
M	Plug connector, with lead wire (Light/surge voltage suppressor)
MO	Plug connector, without lead wire (Light/surge voltage suppressor)

Voltage

Symbol	Specifications
5	24 VDC
6	12 VDC

Function

Symbol	Specifications
Nil	Standard
R	External pilot ^{Note)}

Note) Not compatible with dual 3-port valves.
The 3(R) port is released to the atmosphere.
(Pressurization and vacuum are not allowed.)

How to Order Manifold Assembly

Specify the part numbers for valves and options together beneath the manifold base part number.

<Example>
Connector kit

10-SS0755-07C4C... 1 set - Manifold base part no.
= 10-S0715-5G..... 3 sets - Valve part no. (Stations 1 to 3)
= 10-S0725-5G..... 2 sets - Valve part no. (Stations 4 to 5)
= 10-S07A5-5G..... 2 sets - Valve part no. (Stations 6 to 7)

Prefix the asterisk to the part no. of the solenoid valve, etc.

Write sequentially from the 1st station on the D side. When part no. written collectively are complicated, specify on the manifold specification sheet.

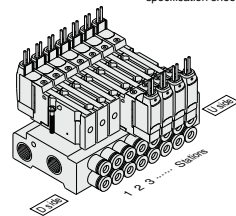

10-SS0755-□ M5
 □ C □
 □ N □

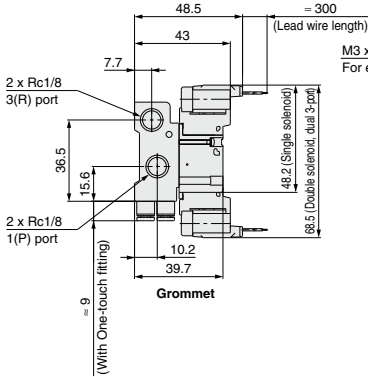

M3 x 0.5 external pilot port
 For external pilot specifications

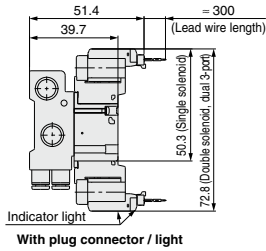
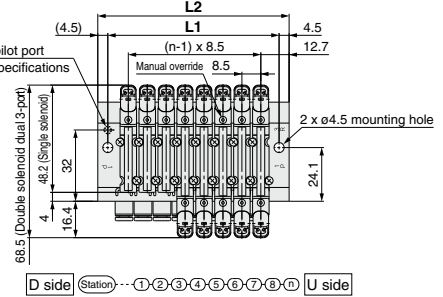

With plug connector / light

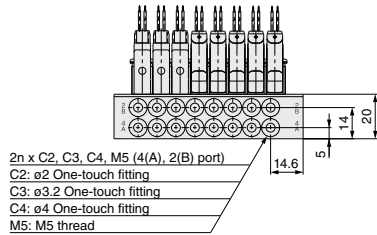

Dimensions

Formula L1 = 8.5n + 8.9, L2 = 8.5n + 17.9 n: Station (Maximum 20 stations)

L \ n	2	3	4	5	6	7	8	9	10	11	12	13	14	15	16	17	18	19	20
L1	25.9	34.4	42.9	51.4	59.9	68.4	76.9	85.4	93.9	102.4	110.9	119.4	127.9	136.4	144.9	153.4	161.9	170.4	178.9
L2	34.9	43.4	51.9	60.4	68.9	77.4	85.9	94.4	102.9	111.4	119.9	128.4	136.9	145.4	153.9	162.4	170.9	179.4	187.9

Directional Control Valves

Air Cylinders

Rotary Actuators

Air Grippers

Air Preparation Equipment

Modular F. R.

Pressure Control Equipment

Fittings & Tubing

Flow Control Equipment

Pressure Switches/ Pressure Sensors

Plug Lead Manifold Bar Base

Serial Transmission

S kit

Plug Lead Manifold
Bar Base

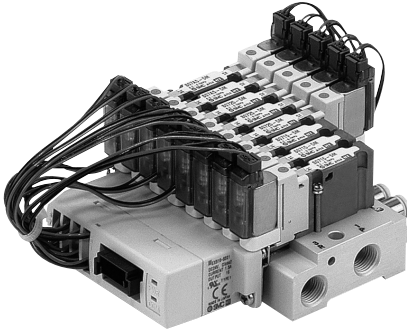

Gateway-type
Serial Transmission
System

EX510

Connect all wiring
using connectors.

Page 495



Directional
Control Valves

Air Cylinders

Rotary Actuators

Air Grippers

Air Preparation
Equipment

Modular F. R.

Pressure Control
Equipment

Fittings & Tubing

Flow Control
Equipment

Pressure Switches/
Pressure Sensors



Series 10-S0700 Plug Lead Manifold Bar Base kit (Serial Transmission) EX510 Gateway-type Serial Transmission System

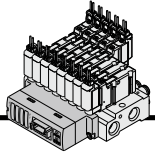

How to Order Manifold

10-SS0755-SA [] 08 C4 [] - []

Clean series

S kit
EX510 serial wiring

SI unit COM.

Nil	+COM.
N	-COM.

Stations

Symbol	Stations
02	2 stations
:	:
16	16 stations

Note) The maximum number of stations is determined by the total number of solenoids.
For mixed single and double wirings, enter "K" to the order code options.

Standard station	Max. number of stations for special wiring specifications	Max. number of solenoids
1 to 8 stations	16 stations	16

Actuation type	Single	Double, Dual 3-port
Number of solenoids	1	2

Refer to the **WEB catalog** for details on the EX510 Gateway-type Serial Transmission System.

Option

Symbol	Specifications
Nil	None
K ^{Note 2)}	Special wiring specifications (Except double wiring)
R ^{Note 3)}	External pilot

Note 1) When two or more options are specified, indicate them alphabetically. Example) -KR
Note 2) Indicate the wiring specifications for mixed single and double wirings.
Note 3) For details, refer to page 497.

* For manifold optional parts, refer to pages 497 to 498.

P, R port thread type

Symbol	Manifold pitch
Nil	8.5
NII	Rc (PT)
F	G (PF)
N	NPT
T	NPTF

Cylinder port size

Symbol	Port size	
M5	M5 thread	Metric
C2	With ø2 One-touch fitting	
C3	With ø3.2 One-touch fitting	
C4	With ø4 One-touch fitting	
CM	Mixed sizes and with port plug ^{Note)}	Inch
N1	With ø1/8" One-touch fitting	
N3	With ø5/32" One-touch fitting	
NM	Mixed sizes and with port plug ^{Note)}	

Note) Specify "Mixed sizes and with port plug" on the manifold specification sheet.

How to Order Valve

10-S07 1 5 [] - 5 MO

Clean series

Actuation type

Symbol	Specifications
1	2-position single
2	2-position double
A	4-position dual 3-port (N.C. + N.C.) [Exhaust center]
B	4-position dual 3-port (N.O. + N.O.) [Pressure center]
C	4-position dual 3-port (N.C. + N.O.)

Note) For symbol, refer to page 423

Electrical entry

M-type plug connector, without lead wire (Light/surge voltage suppressor)

Voltage: 24 VDC

Function

Symbol	Specifications
Nil	Standard
R	External pilot ^{Note)}

Note) Not compatible with dual 3-port valves.
The 3(R) port is released to the atmosphere. (Pressurization and vacuum are not allowed.)

Base mounted plug lead

How to Order Manifold Assembly

Specify the part numbers for valves and options together beneath the manifold base part number.

<Example>

Serial transmission kit

10-SS0755-SA08C4... 1 set - Manifold base part no.

= 10-S0715-5MO 3 sets - Valve part no. (Stations 1 to 3)

= 10-S0725-5MO 3 sets - Valve part no. (Stations 4 to 6)

= 10-S07A5-5MO 2 sets - Valve part no. (Stations 7 to 8)

Prefix the asterisk to the part no. of the solenoid valve, etc.

Write sequentially from the 1st station on the D side. When part no. written collectively are complicated, specify on the manifold specification sheet. The connector assembly lead wire length used for EX510 manifold varies depending on the number of stations.

Therefore, solenoid valves (including a blanking plate) and connector assembly are assembled when shipped as a standard specification. Please specify the mounting solenoid valve when ordering.

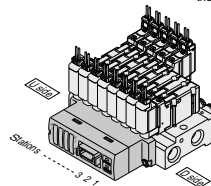

10-SS0755
S kit (Serial transmission: EX510)

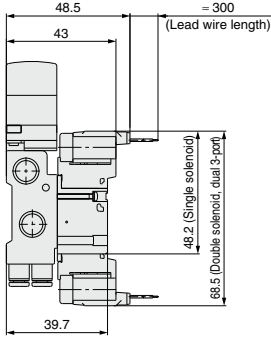

Grommet

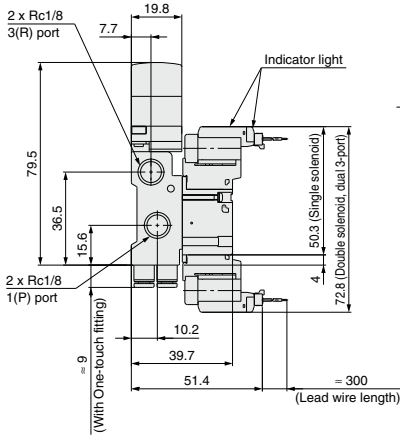

With plug connector / light

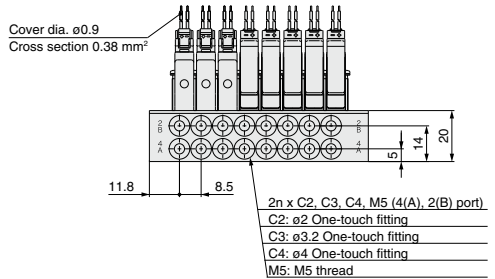
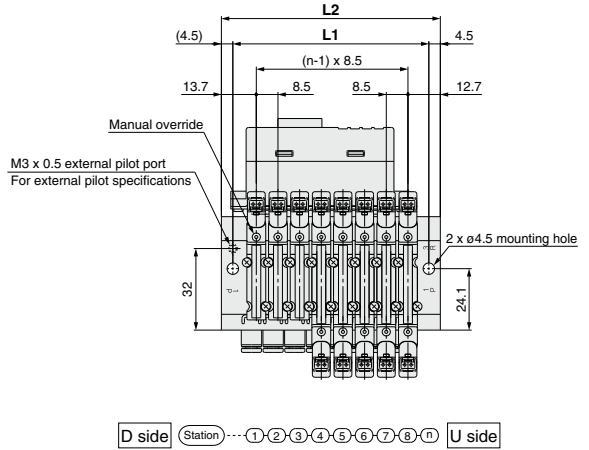
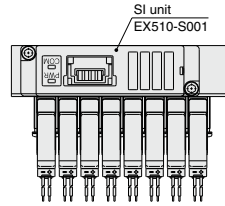

Dimensions

L	n	2	3	4	5	6	7	8	9	10	11	12	13	14	15	16
L1		68.4	68.4	68.4	68.4	68.4	68.4	76.9	85.4	93.9	102.4	110.9	119.4	127.9	136.4	144.9
L2		77.4	77.4	77.4	77.4	77.4	77.4	85.9	94.4	102.9	111.4	119.9	128.4	136.9	145.4	153.9

Directional Control Valves

Air Cylinders

Rotary Actuators

Air Grippers

Air Preparation Equipment

Modular F. R.

Pressure Control Equipment

Fittings & Tubing

Flow Control Equipment

Pressure Switches/ Pressure Sensors

Series 10-S0700 Plug Lead Manifold Bar Base

Manifold Optional Parts

Blanking plate assembly

SS0700-10A-5

It is used by attaching on the manifold block for being prepared for removing a valve for maintenance reasons or planning to mount a spare valve, etc.

Weight: 21 g

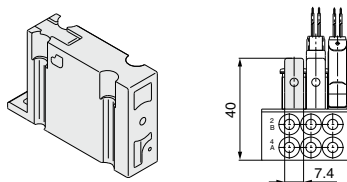

Individual SUP spacer

SS0700-P-5-M5

Port size

M5 M5 thread

Mounted on the manifold block to make an independent supply port when each solenoid valve uses different operating pressure.

Weight: 7 g

* Compatible with 8.5 mm pitch manifold only.

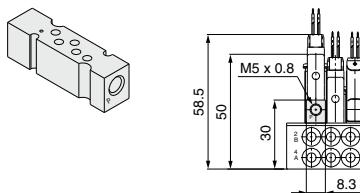

Individual EXH spacer

SS0700-R-5-M5

Port size

M5 M5 thread

Mounted on the manifold block to make an independent exhaust port when the exhaust from one valve affects valves on other stations in the air circuit.

Weight: 7 g

* Compatible with 8.5 mm pitch manifold only.

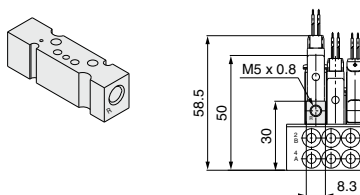

Port plug

VVQ000-CP

The plug is used to block the cylinder port when using a 5-port valve as a 3-port valve.

* When ordering a plug incorporated with a manifold, indicate "CM" for the port size in the manifold no., as well as, the mounting position and number of stations and cylinder port mounting positions, A and B, on the manifold specification sheet.

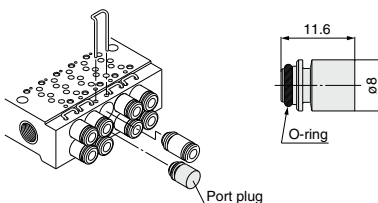

External pilot [-R]

This can be used when the air pressure is 0.1 to 0.2 MPa lower than the minimum operating pressure of the solenoid valves or used for vacuum specifications.

Add R to the part numbers of manifolds and valves to indicate the external pilot specifications.

An M5 port will be installed on the top side of the manifold's SUP/EXH block.

● How to Order Valve (Example)

10-S0715 B -5G

External pilot

● How to Order Manifold (Example)

* Indicate -R for an option.

10-SS0755-08C4C-B

External pilot

External pilot port
(M3 x 0.5)

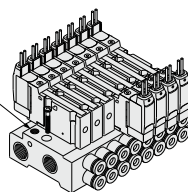

Note 1) The dual 3-port valve is not available.

Note 2) When the internal pilot type and external pilot type of valves are mixed up on the manifold, order the manifold suitable for the specifications of the external pilot valve.

Note 3) Since the pilot EXH of valves with the external pilot specification also has a common exhaust specification, the 3(R) port should be released to the atmosphere.

Blanking plug (For One-touch fittings)

KJP-02

23

KQ2P-04

06

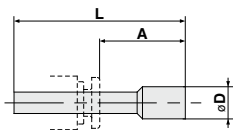
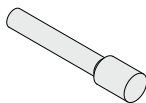

Dimensions

(mm)

Applicable fitting size ϕD	Model	A	L	D	Weight (g)
2	KJP-02	8.2	17	3	0.1
3.2	KQ2P-23	16	31.5	3.2	1
4	KQ2P-04	16	32	6	1
6	KQ2P-06	18	35	8	1

Directional Control Valves

Air Cylinders

Rotary Actuators

Air Grippers

Air Preparation Equipment

Modular F. R.

Pressure Control Equipment

Fittings & Tubing

Flow Control Equipment

Pressure Switches/ Pressure Sensors

Series 10-S0700

5 Port Solenoid Valve:
Base Mounted
Plug Lead, Single Unit

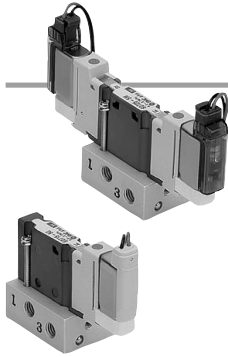

How to Order Valve

10-S07 1 5 □ - 5 G - M5

Clean series

Actuation type

Symbol	Specifications
1	2-position single
2	2-position double
A	4-position dual 3-port (N.C. + N.C.) [Exhaust center]
B	4-position dual 3-port (N.O. + N.O.) [Pressure center]
C	4-position dual 3-port (N.C. + N.O.)

Note) For symbol, refer to page 423.

Plug lead

Function

Symbol	Specifications
Nil	Standard
R	External pilot ^{Note)}

Note) Not compatible with dual 3-port valves.

Sub-plate

Symbol	Specifications
Nil	Without sub-plate
M5	With sub-plate

Electrical entry

Symbol	Specifications	Configuration
G	Grommet	
M	M-type plug connector, with lead wire (With light/surge voltage suppressor)	
MO	M-type plug connector, without lead wire (With light/surge voltage suppressor)	

Voltage

Symbol	Specifications
5	24 VDC
6	12 VDC

Dimensions

2-Position Single

Grommet (G): 10-S0715(R)-□G-M5

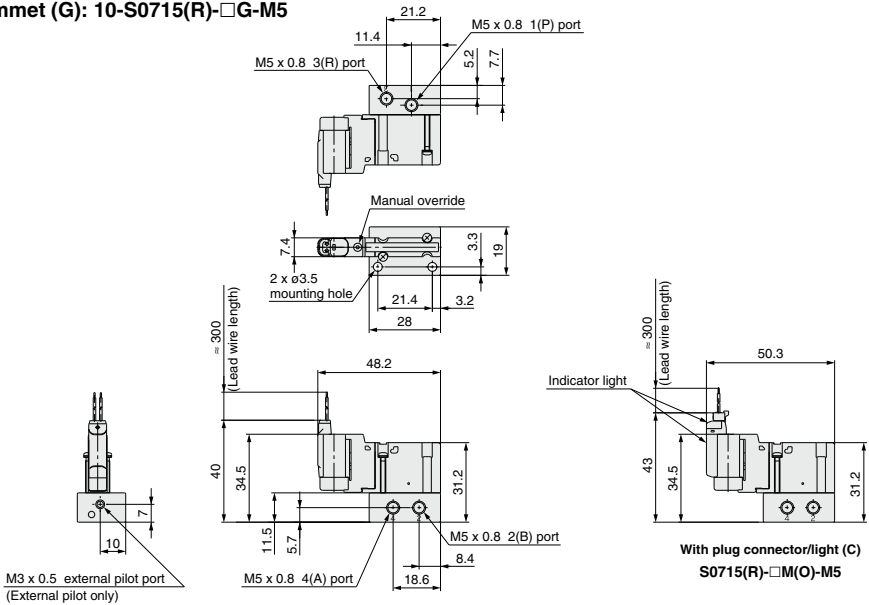

2-Position Double/4-Position Dual 3-Port

Grommet (G): 10-S0715(R)-□G-M5

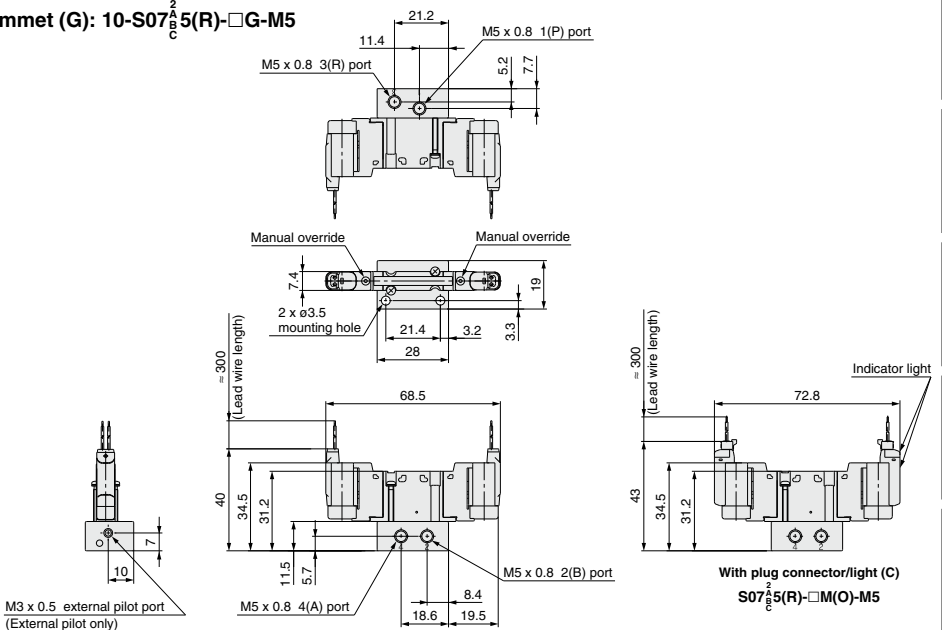

Directional Control Valves

Air Cylinders

Rotary Actuators

Air Grippers

Air Preparation Equipment

Modular F. R.

Pressure Control Equipment

Fittings & Tubing

Flow Control Equipment

Pressure Switches/Pressure Sensors

Series 10-S0700 Plug Lead Single Unit

Construction: Main Parts/Replacement Parts

2-Position Single

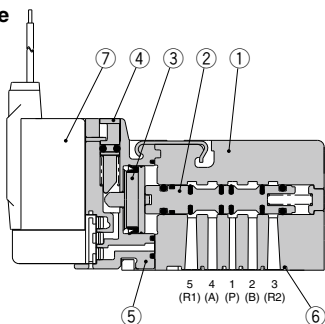

S0715

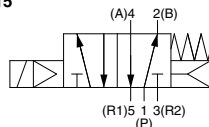

2-Position Double

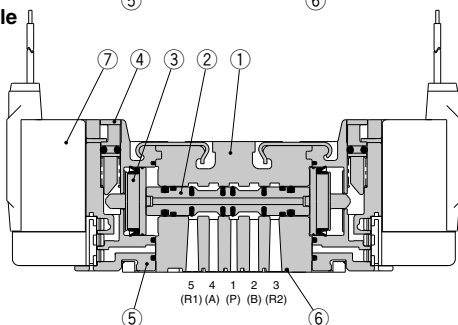

S0725

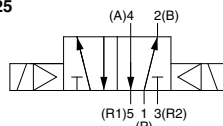

4-Position Dual 3-Port Valve

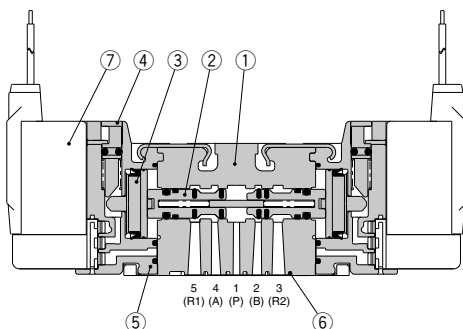

S07A5

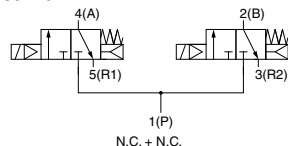

S07B5

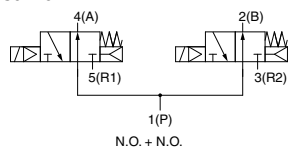

S07C5

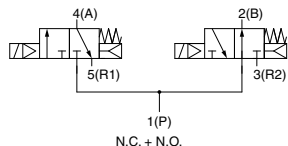

<Pilot Valve Assembly Part No.>

S070P - 5 B G -1

Voltage

Symbol	Specifications
5	24 VDC
6	12 VDC

Accessory

Symbol	Specifications
Nil	None
-1	Stopper plate is included.

Electrical entry

Symbol	Specifications
G	Grommet
C	Plug connector, with lead wire (With light/surge voltage suppressor)
CO	Plug connector, without lead wire (With light/surge voltage suppressor)

Component Parts

No.	Description	Material
1	Body	Zinc die-casted
2	Spool	Aluminum
3	Piston	Resin
4	Manual override	Resin
5	Adapter plate	Resin
6	Interface gasket	HNBR

Replacement Parts

No.	Description	Material
7	Pilot valve assembly	—

Note) For pilot valve assembly replacement, refer to the Specific Product Precautions 3.

Note) For pilot valve assembly replacement, refer to the Specific Product Precautions 3.

Series 10-S0700 Plug Lead Replacement Parts

<One-touch Fitting Assembly (For Cylinder Port)>

Manifold pitch	Port size	Part no.
8.5	ø2 One-touch fitting	VVQ0000-50A-C2
	ø3.2 One-touch fitting	VVQ0000-50A-C3
	ø4 One-touch fitting	VVQ0000-50A-C4
	ø1/8" One-touch fitting	VVQ0000-50A-N1
	ø5/32" One-touch fitting	VVQ0000-50A-N3
7.5	ø2 barb fitting	SS070-50A-20
	ø3.2 barb fitting	SS070-50A-32
	ø4 barb fitting	SS070-50A-40

Note) Purchase orders are available in units of 10 pieces.

<Plug Connector Assembly>

S070-14A-□

Lead wire length

Symbol	Length
Nil	150 mm
3	300 mm
6	600 mm
10	1000 mm

Note) Standard wire length of valve with plug connector is 300 mm. When ordering a lead wire length of 600 mm or longer, list the part numbers for the valve without connector and the connector assembly.

<Pilot Valve Assembly>

10-S070P-5 B G -1

Voltage

Symbol	Specifications
5	24 VDC
6	12 VDC

Accessory

Symbol	Specifications
Nil	None
-1	Stopper plate is included.

Electrical entry

Symbol	Specifications
G	Grommet
C	Plug connector, with lead wire (With light/surge voltage suppressor)
CO	Plug connector, without lead wire (With light/surge voltage suppressor)

Note) For pilot valve assembly replacement, refer to the Specific Product Precautions 3.

<Gasket, Screw Assembly>

Part no.
S0700-GS-5

Note) Above part number consists of 10 units.
Each unit has one gasket and two screws.

<Sub-plate>

Part no.
S0700-S-M5

<SI Unit (Series EX510)>

EX510-S 0 01

Output specifications

0	NPN output (+COM.)
1	PNP output (-COM.)

Directional
Control Valves

Air Cylinders

Rotary Actuators

Air Grippers

Air Preparation
Equipment

Modular F. R.

Pressure Control
Equipment

Fittings & Tubing

Flow Control
Equipment

Pressure Switches/
Pressure Sensors



Series 10-S0700

Specific Product Precautions 1

Be sure to read this before handling.

Refer to page 1382 for Safety Instructions and pages 677 to 683 for 3/4/5 Port Solenoid Valve Precautions.

Manual Override

Warning

The manual override is used for switching the main valve.

Push type (Tool required)

Push down on the manual override button with a small screwdriver until it stops.

Plug-in

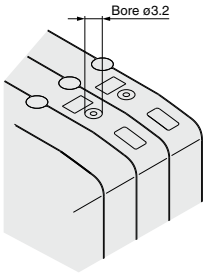

Plug lead

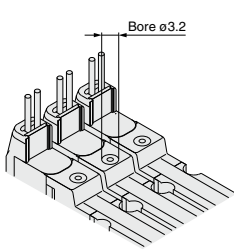

How to Attach/Detach Plug Connector

<Plug lead type only>

To attach a connector, hold the lever and connector unit between your fingers and insert straight onto the pins of the solenoid valve so that the lever's pawl is pushed into the groove and locks.

To detach a connector, remove the pawl from the groove by pushing the lever downward with your thumb, and pull the connector straight out.

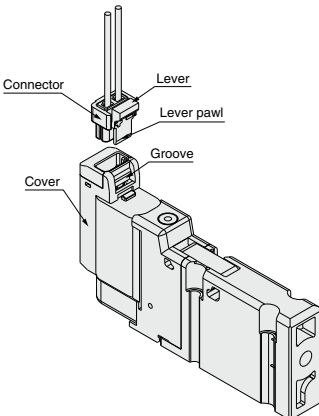

(Note) In order not to damage the connector and cover, do not pull the lead wire excessively (with a force of 10 N or more).

How to Mount Valve

Caution

Tighten the bolts firmly to stop the gasket from coming away from the valve using the appropriate torque as shown on the following table.

Proper tightening torque N·m
0.17 to 0.23

Plug-in

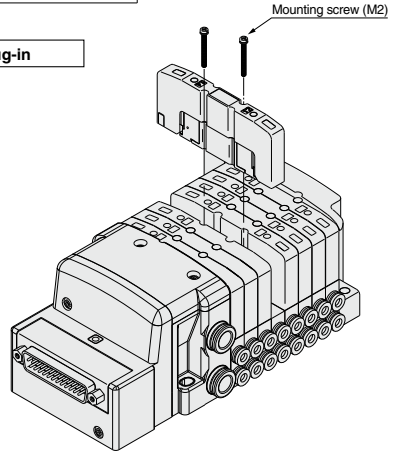

Plug lead

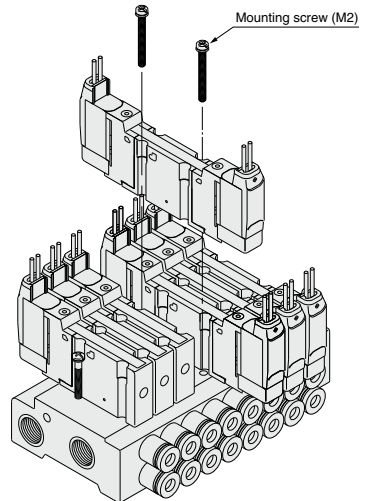



Series 10-S0700

Specific Product Precautions 2

Be sure to read this before handling.

Refer to page 1382 for Safety Instructions and pages 677 to 683 for 3/4/5 Port Solenoid Valve Precautions.

How to Mount/Remove DIN Rail

⚠ Caution

Plug-in

Removal

- Loosen the clamping screw of the end plate on both sides.
- Lift side (a) of the manifold base and slide the end plate in the direction of ② shown in the figure to remove.

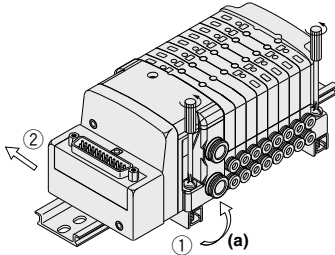

Mounting

- Hook side (b) of the manifold base on the DIN rail.
- Press down side (a) and mount the end plate on the DIN rail. Tighten the clamping screw on side (a) of the end plate. The proper tightening torque for screws is 0.4 to 0.6 N·m.

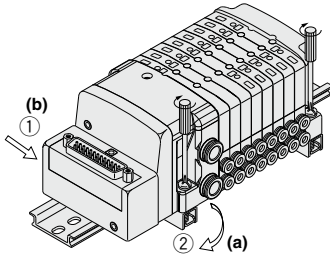

How to Change Connector Entry Direction

⚠ Caution

<Plug-in manifold stacking base>

The connector entry direction can be changed from the top to the side by simply pressing the manual release button.

It is not necessary to use the manual release button when switching from the side to the top.

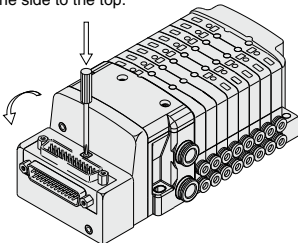

How to Replace Cylinder Port Fittings

⚠ Warning

The cylinder port fittings are a cassette for easy replacement. The fittings are blocked by a clip inserted from the top of the valve.

Remove the clip with a flat blade screwdriver to remove fittings. For replacement, insert the fitting assembly until it strikes against the inside wall and then re-insert the clip to the specified position.

Plug-in

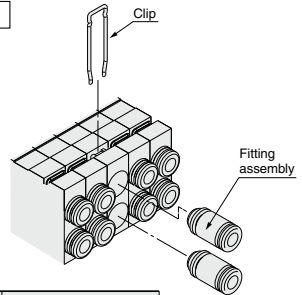

Applicable tubing O.D.	One-touch fitting part no.
Applicable tubing ø2	VVQ0000-50A-C2
Applicable tubing ø3.2	VVQ0000-50A-C3
Applicable tubing ø4	VVQ0000-50A-C4
Applicable tubing ø1/8"	VVQ0000-50A-N1
Applicable tubing ø5/32"	VVQ0000-50A-N3

- * Part number is for one fitting assembly.
- * Please order it in units of 10 pieces.

Plug lead

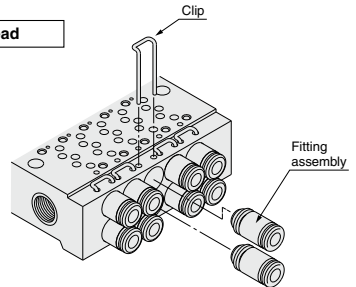

	Applicable tubing O.D.	Fitting part no.
8.5 mm pitch (One-touch fitting)	Applicable tubing ø2	VVQ0000-50A-C2
	Applicable tubing ø3.2	VVQ0000-50A-C3
	Applicable tubing ø4	VVQ0000-50A-C4
	Applicable tubing ø1/8"	VVQ0000-50A-N1
	Applicable tubing ø5/32"	VVQ0000-50A-N3
7.5 mm pitch (Barb fitting)	Barb fitting ø2	SS070-50A-20
	Barb fitting ø3.2	SS070-50A-32
	Barb fitting ø4	SS070-50A-40

- * Part number is for one fitting assembly.
- * Please order it in units of 10 pieces.

Directional Control Valves

Air Cylinders

Rotary Actuators

Air Grippers

Air Preparation Equipment

Modular F. R.

Pressure Control Equipment

Fittings & Tubing

Flow Control Equipment

Pressure Switches/ Pressure Sensors



Series 10-S0700

Specific Product Precautions 3

Be sure to read this before handling.

Refer to page 1382 for Safety Instructions and pages 677 to 683 for 3/4/5 Port Solenoid Valve Precautions.

Internal Wiring Specifications

⚠ Caution

Light/surge voltage suppressor

No polarity by adopting non-polar light.

Plug-in Single/All plug lead types

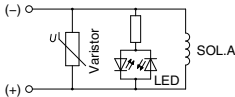

Plug-in Double, Dual 3-port

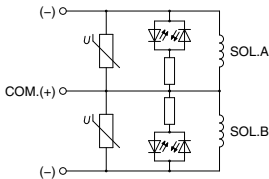

Note) Coil surge voltage generated when OFF is about -60 V. Please contact SMC separately for further suppression of the coil surge voltage.

Plug-in

Slim type plug-in manifold

A: Red
B: Green

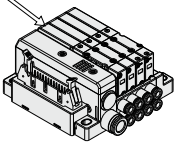

Plug-in manifold

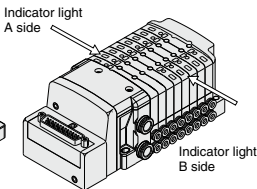

Plug lead manifold

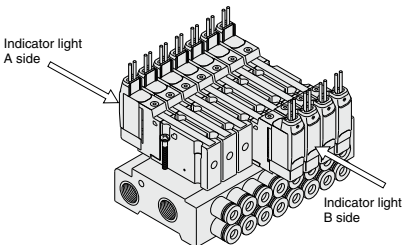

Surge Voltage Intrusion

⚠ Caution

The surge voltage created when the power supply is cut off could apply to the de-energized load equipment through the output circuit. In cases where the energized load equipment has a larger capacity (power consumption) and is connected to the same power supply as the product, the surge voltage could malfunction and/or damage the internal circuit element of the product and the internal device of the output equipment. To avoid this situation, place a diode which can suppress the surge voltage between the COM lines of the load equipment and output equipment.

How to Replace Pilot Valve

⚠ Caution

<Plug lead>

Removal

- 1) Remove the stopper plate from the adapter plate assembly by using a flat blade screwdriver on the concave of the stopper plate.
- 2) Take off the pilot valve in horizontal direction.

Mounting

- 1) Mount the pilot valve on the adapter plate assembly.
- 2) Insert the stopper plate into the adapter plate so that the stopper plate will not protrude from the end of the adapter plate.

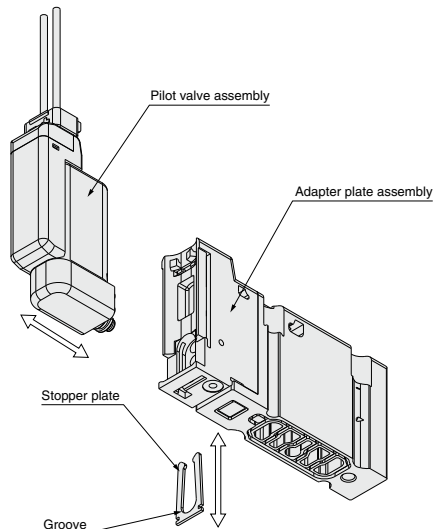



Series 10-S0700

Specific Product Precautions 4

Be sure to read this before handling.

Refer to page 1382 for Safety Instructions and pages 677 to 683 for 3/4/5 Port Solenoid Valve Precautions.

EX500/EX250/EX260

Warning

- These products are intended for use in general factory automation equipment.
Avoid using these products in machinery/equipment which affects human safety, and in cases where malfunction or failure can result in extensive damage.
- Do not use in an explosive atmosphere, environment with inflammable gases, or corrosive atmosphere. This can cause injury or fire, etc.
- Work such as transporting, installing, piping, wiring, operation, control and maintenance should be performed by personnel with specialized knowledge. There is a danger of electrocution, injury or fire, etc.
- Install an external emergency stop circuit that can promptly stop operation and shut off the power supply.
- Do not remodel these products, as there is a danger of injury and damage.

Caution

- Read the operation manual carefully, strictly observe the precautions and operate within the range of the specifications.
- Do not drop these products or submit them to strong impacts. This can cause damage, failure or malfunction, etc.
- In locations with poor electrical conditions, take steps to ensure a steady flow of the rated power supply. Use of a voltage outside of the specifications can cause malfunction, damage to the unit, electrocution or fire, etc.
- Do not touch connector terminals or internal substrates when current is being supplied. There is a danger of malfunction, damage to the unit or electrocution if connector terminals or internal substrates are touched when current is being supplied.

Be sure that the power supply is OFF when adding or removing manifold valves or input blocks, etc., or when connecting or disconnecting connectors.

- Operate at an ambient temperature that is within the specifications. Even when the ambient temperature range is within the specifications, do not use in locations where there are rapid temperature changes.
- Keep wire scraps and other extraneous material from getting inside these products. This can cause fire, failure or malfunction, etc.
- This product is not constructed to withstand water or oil penetration. Therefore it should be fitted with a protective cover when used in environments where it could be exposed to water or oil splash.
- Observe the proper tightening torque.
There is a possibility of damaging threads if tightening exceeds the tightening torque range.

9. Adjustment/Operation

DIP switches and rotary switches should be set with a small watchmakers' screwdriver.

Caution

- Provide adequate protection when operating in locations such as the following:
 - Where noise is generated by static electricity, etc.
 - Where there is a strong electric field
 - Where there is a danger of exposure to radiation
 - When in close proximity to power supply lines
- When these products are installed in equipment, provide adequate protection against noise by using noise filters, etc.
- Since these products are components that are used after installation in other equipment, the customer should confirm conformity to EMC directives for the finished product.
- Do not remove the name plate.
- Perform periodic inspections and confirm normal operation. It may otherwise be impossible to guarantee safety due to unexpected malfunction or erroneous operation.

Safety Instructions on Power Supply

Caution

- Operation is possible with a single power supply or a separate power supply. However, be sure to provide two wiring systems (one for solenoid valves, and one for input and control units).
- Use the following UL approved products for DC power supply combinations.

- Controlled voltage current circuit conforming to UL508
Circuit uses the secondary coil of an isolated transformer as the power supply, satisfying the following conditions.
 - Max. voltage (with no load): 30 Vrms (42.4 V peak) or less
 - Max. current: (1) 8 A or less (including shorts), and
(2) When controlled by a circuit protector (fuse, etc.) with the following rating

No-load voltage (V peak)	Max. current rating
0 to 20 [V]	5.0
Over 20 [V] to 30 [V]	100
	Peak voltage value

- A circuit (class 2 circuit) with maximum 30 Vrms (42.4 V peak) or less, and a power supply consisting of a class 2 power supply unit conforming to UL1310, or a class 2 transformer conforming to UL1585

Directional Control Valves

Air Cylinders

Rotary Actuators

Air Grippers

Air Preparation Equipment

Modular F. R.

Pressure Control Equipment

Fittings & Tubing

Flow Control Equipment

Pressure Switches/ Pressure Sensors



Series 10-S0700

Specific Product Precautions 5

Be sure to read this before handling.

Refer to page 1382 for Safety Instructions and pages 677 to 683 for 3/4/5 Port Solenoid Valve Precautions.

EX500/EX250

Safety Instructions on Cable

⚠ Caution

1. Be careful of miswiring. This can cause malfunction, damage and fire in the unit.
2. Do not connect cables during energizing.
This could damage or cause malfunction to the SI unit.
3. To prevent noise and surge in signal lines, keep all wiring separate from power lines and high voltage lines. Otherwise, this can cause malfunction.
4. Check wiring insulation, as defective insulation can cause damage to the unit due to excessive voltage or current.
5. Do not bend or pull cables repeatedly, and do not place heavy objects on them or allow them to be pinched. This can cause broken lines.

EX510

Design/Selection

⚠ Warning

1. Use within the allowable voltage range.
Using beyond the allowable voltage range is likely to cause the units and connecting devices to be damaged or to malfunction.
2. Do not use beyond the specification range.
Using beyond the specification range is likely to cause a fire, malfunction, or breakdown in the units and connecting devices. Check the specifications before handling.
3. Establish a backup system beforehand, which employs fail-safe concepts such as multiple equipment and devices to prevent breakage or malfunction of this product.
4. Provide an external emergency stop circuit that will immediately stop an operation and cut off the power supply.
5. When using for an interlock circuit:
 - Provide a double interlock which is operated by another system (such mechanical protection function).
 - Perform an inspection to check that it is working properly because it can cause possible injuries.

⚠ Caution

1. Keep the surrounding space free for maintenance.
When designing a system, take into consideration the amount of free space needed for performing maintenance.
2. Use the following UL approved products for DC power supply combinations.
 - 1) Controlled voltage current circuit conforming to UL508
Circuit uses the secondary coil of an isolated transformer as the power supply, satisfying the following conditions.
 - Max. voltage (with no load): 30 Vrms (42.4 V peak) or less
 - Max. current: (1) 8 A or less (including shorts), and (2) When controlled by a circuit protector (fuse, etc.) with the following rating

No-load voltage (V peak)	Max. current rating
0 to 20 [V]	5.0
Over 20 [V] to 30 [V]	100
	Peak voltage value
 - 2) A circuit (class 2 circuit) with maximum 30 Vrms (42.4 V peak) or less, and a power supply consisting of a class 2 power supply unit conforming to UL1310, or a class 2 transformer conforming to UL1585
3. This product is one of the components to be equipped into a final equipment. Confirm the adaptability to the EMC directive as the whole equipment by customers themselves.
4. The power supply for the Gateway unit should be 0 V as the standard for both power supply for outputs as well as inputs and for the control unit of the Gateway.

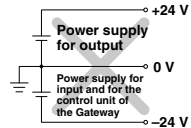
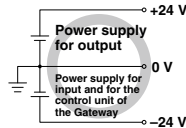



Series 10-S0700

Specific Product Precautions 6

Be sure to read this before handling.

Refer to page 1382 for Safety Instructions and pages 677 to 683 for 3/4/5 Port Solenoid Valve Precautions.

EX510

Mounting

⚠ Caution

- 1. Do not drop, bump, or apply excessive impact.**
Otherwise, the unit can become damaged, malfunction, or fail to function.
- 2. Hold the body while handling this product.**
Otherwise, the unit can become damaged, malfunction, or fail to function.
- 3. Observe the tightening torque range.**
Tightening outside of the allowable torque range will likely damage the product.
- 4. Do not install a unit in a place where it can be used as a scaffold.**
Applying any excessive load such as stepping on the unit by mistake or placing a foot on it, will cause it to break.

Wiring

⚠ Warning

- 1. Avoid miswiring.**
If miswired, there is a probability of damaging units or connecting devices.
- 2. Do not wire while energizing the product.**
It is likely to damage the units or connecting devices.
- 3. Avoid wiring the power line and high pressure line in parallel.**
Noise or surge produced by signal line resulting from the power line or high pressure line could cause a malfunction. Wiring of the reduced wiring system and the power line or high pressure line should be separated from each other.
- 4. Check the wiring insulation.**
Inferior insulation (contact with other circuit, insulation between terminals, etc.) will likely cause damage to the units or connecting devices due to excessive voltage or the influx of current.

⚠ Caution

- 1. Take measures to avoid applying repeated bending force or pulling force to the cable.**
Also, pay attention not to place any heavy matter on the cable or clipping. It is likely to cause a broken wire.
- 2. Check the grounding to maintain the safety of the reduced wiring system and for anti-noise performance.**
Grounding should be close to units and keep the grounding distance short.

Operating Environment

⚠ Warning

- 1. Do not use this product in the presence of dust, particles, water, chemicals, and oil.**
Use with such materials is likely to cause a malfunction or breakage.
- 2. Do not use this product in the presence of a magnetic field.**
Use in such an environment is likely to cause a malfunction.
- 3. Do not use this product in an atmosphere containing an inflammable gas, explosive gas, or corrosive gas.**
Use in such an atmosphere is likely to cause a fire, explosion, or corrosion. This wire-reduced system is not explosion-proof.
- 4. Do not use this product in places where there are cyclic temperature changes.**
In case that the cyclic temperature is beyond normal temperature changes, the internal unit is likely to be adversely affected.
- 5. Do not use this product in places where there is radiated heat around it.**
Such a place is likely to cause a malfunction or breakage.
- 6. Do not use this product near sources that generate a surge which exceeds the benchmark test, even though this product is CE-marked certified.**
The internal circuit components are likely to deteriorate or become damaged when there are equipment (solenoid type lifter, high frequency guided furnace, motor, etc.) which generate a large surge around the reduced wiring system. Take measures to prevent an electrical surge and avoid having the wires touch each other.
- 7. Use the product type that has an integrated surge absorption element when directly driving a load which generates surge voltage by relay or solenoid valves.**
- 8. The reduced wiring system should be installed in places with no vibration or shock.**
Such a place is likely to cause a malfunction or breakage.

Directional Control Valves

Air Cylinders

Rotary Actuators

Air Grippers

Air Preparation Equipment

Modular F. R.

Pressure Control Equipment

Fittings & Tubing

Flow Control Equipment

Pressure Switches/ Pressure Sensors



Series 10-S0700

Specific Product Precautions 7

Be sure to read this before handling.

Refer to page 1382 for Safety Instructions and pages 677 to 683 for 3/4/5 Port Solenoid Valve Precautions.

EX510

Adjustment/Operation

Warning

1. Do not short-circuit a load.

If a load is short-circuited, excessive current can cause damage to the connected devices. The fuse of the input unit will melt. The output and SI unit will activate its overcurrent protection function. However, they cannot cover all modes, so damage is likely to occur.

2. Do not manipulate or perform settings with wet hands.

Performing such activity will likely cause an electrical shock.

Caution

1. DIP switches and rotary switches should be set with a small watchmakers' screwdriver.

Maintenance

Warning

1. Do not disassemble, modify (including circuit board replacement) or repair this product.

Such actions are likely to cause injuries or breakage.

2. Perform periodic inspection.

Confirm that wiring or screws are not loose. Otherwise, unpredicted malfunction in the system composition devices is likely to occur.

3. When an inspection is performed.

- Turn off the power supply.
- Stop the supplied fluid and discharge the fluid in the piping and confirm the release to the atmosphere before performing an inspection. It is likely to cause injuries.

Caution

1. Do not wipe this product with chemicals such as benzene or thinner.

Using such chemicals is likely to cause damage.



Series 10-S0700

Specific Product Precautions 8

Be sure to read this before handling.

Refer to page 1382 for Safety Instructions and pages 677 to 683 for 3/4/5 Port Solenoid Valve Precautions.

EX600

Design/Selection

Warning

- Use this product within the specification range.**
Using beyond the specified specifications range can cause fire, malfunction, or damage to the system. Check the specifications when operating.
- When using for an interlock circuit:**
 - Provide a multiple interlock system which is operated by another system (such as mechanical protection function).
 - Perform an inspection to confirm that it is working properly. This may cause possible injury due to malfunction.

Caution

- Use the following UL approved products for DC power supply combinations.**
 - Controlled voltage current circuit conforming to UL508
Circuit uses the secondary coil of an isolated transformer as the power supply, satisfying the following conditions.
 - Max. voltage (with no load): 30 Vrms (42.4 V peak) or less
 - Max. current: (1) 8 A or less (including shorts), and (2) When controlled by a circuit protector (fuse, etc.) with the following rating

No-load voltage (V peak) 0 to 20 [V]	Max. current rating
	5.0
Over 20 [V] to 30 [V]	100 Peak voltage value
 - A circuit (class 2 circuit) with maximum 30 Vrms (42.4 V peak) or less, and a power supply consisting of a class 2 power supply unit conforming to UL1310, or a class 2 transformer conforming to UL1585

- Use this product within the specified voltage range.**
Using beyond the specified voltage range is likely to cause the units and connecting devices to be damaged or to malfunction.
- The power supply for the unit should be 0 V as the standard for both power supply for output as well as power supply for control/input.**

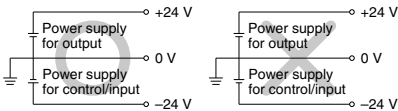

- Do not install a unit in a place where it can be used as a foothold.**
Applying any excessive load such as stepping on the unit by mistake or placing a foot on it, will cause it to break.
- Keep the surrounding space free for maintenance.**
When designing a system, take into consideration the amount of free space needed for performing maintenance.
- Do not remove the name plate.**
Improper maintenance or incorrect use of operation manual can cause failure and malfunction. Also, there is a risk of losing conformity with safety standards.
- Beware of inrush current when the power supply is turned on.**
Some connected loads can apply an initial charge current which will trigger the over current protection function, causing the unit to malfunction.

Mounting

Caution

- When handling and assembling units:**
 - Do not touch the sharp metal parts of the connector or plug.**
Do not apply excessive force to the unit when disassembling.
The connecting portions of the unit are firmly joined with seals.
 - When joining units, take care not to get fingers caught between units.**
Injury can result.
- Do not drop, bump, or apply excessive impact.**
Otherwise, the unit can become damaged, malfunction, or fail to function.
- Observe the tightening torque range.**
Tightening outside of the allowable torque range will likely damage the product.
IP67 protection class cannot be guaranteed if the screws are not tightened to the specified torque.
- When lifting a large size manifold solenoid valve unit, take care to avoid causing stress to the valve connection joint.**
The connection parts of the unit may be damaged. Because the unit may be heavy, carrying and installation should be performed by more than one operator to avoid strain or injury.
- When placing a manifold, mount it on a flat surface.**
Torsion in the whole manifold can lead to trouble such as air leakage or defective insulation.

Wiring

Caution

- Check the grounding to maintain the safety of the reduced wiring system and for anti-noise performance.**
Provide a specific grounding as close to the unit as possible to minimize the distance to grounding.
- Avoid repeatedly bending or stretching the cable and applying a heavy object or force to it.**
Wiring applying repeated bending and tensile stress to the cable can break the circuit.
- Avoid miswiring.**
If miswired, there is a danger of malfunction or damage to the reduced wiring system.
- Do not wire while energizing the product.**
There is a danger of malfunction or damage to the reduced wiring system or input/output equipment.

Directional Control Valves

Air Cylinders

Rotary Actuators

Air Grippers

Air Preparation Equipment

Modular F. R.

Pressure Control Equipment

Fittings & Tubing

Flow Control Equipment

Pressure Switches/ Pressure Sensors



Series 10-S0700

Specific Product Precautions 9

Be sure to read this before handling.

Refer to page 1382 for Safety Instructions and pages 677 to 683 for 3/4/5 Port Solenoid Valve Precautions.

EX600

Wiring

Caution

5. **Avoid wiring the power line and high pressure line in parallel.**

Noise or surge produced by signal line resulting from the power line or high pressure line could cause malfunction.

Wiring of the reduced wiring system or input/output device and the power line or high pressure line should be separated from each other.

6. **Check the wiring insulation.**

Defective insulation (contact with other circuits, improper insulation between terminals, etc.) may cause damage to the reduced wiring system or input/output device due to excessive voltage or current.

7. **When a reduced wiring system is installed in machinery/equipment, provide adequate protection against noise by using noise filters, etc.**

Noise in signal lines may cause a malfunction.

8. **When connecting wires of input/output device or handheld terminal, prevent water, solvent or oil from entering inside from the connector section.**

This can cause damage, equipment failure or malfunction.

9. **Avoid wiring patterns in which excessive stress is applied to the connector.**

This may cause malfunction or damage to the unit due to contact failure.

Operating Environment

Warning

1. **Do not use in an atmosphere containing an inflammable gas or explosive gas.**

Use in such an atmosphere is likely to cause a fire or explosion. This system is not explosion-proof.

Caution

1. **Select the proper type of enclosure according to the environment of operation.**

IP65/67 is achieved when the following conditions are met.

- 1) Provide appropriate wiring between all units using electrical wiring cables, communication connectors and cables with M12 connectors.

- 2) Suitable mounting of each unit and manifold valve.

- 3) Be sure to mount a seal cap on any unused connectors.

If using in an environment that is exposed to water splashes, please take measures such as using a cover.

Also, the Handheld Terminal conforms to IP20, so prevent foreign matter from entering inside, and water, solvent or oil from coming in direct contact with it.

Operating Environment

Caution

2. **Provide adequate protection when operating in locations such as the following.**

Failure to do so may cause damage or malfunction.

The effect of countermeasures should be checked in individual equipment and machine.

- 1) Where noise is generated by static electricity, etc.

- 2) Where there is a strong electric field

- 3) Where there is a danger of exposure to radiation

- 4) When in close proximity to power supply lines

3. **Do not use in an environment where oil and chemicals are used.**

Operating in environments with coolants, cleaning solvents, various oils or chemicals may cause adverse effects (damage, malfunction) to the unit even in a short period of time.

4. **Do not use in an environment where the product could be exposed to corrosive gas or liquid.**

This may damage the unit and cause it to malfunction.

5. **Do not use in locations with sources of surge generation.**

Installation of the unit in an area around the equipment (electromagnetic lifters, high frequency induction furnaces, welding machine, motors etc.), which generates the large surge voltage could cause to deteriorate an internal circuitry element of the unit or result in damage. Implement countermeasures against the surge from the generating source, and avoid touching the lines with each other.

6. **Use the product type that has an integrated surge absorption element when directly driving a load which generates surge voltage by relay, solenoid valves or lamp.**

When a surge generating load is directly driven, the unit may be damaged.

7. **The product is CE marked, but not immune to lightning strikes. Take measures against lightning strikes in your system.**

8. **Keep dust, wire scraps and other extraneous material from getting inside the product.**

This may cause a malfunction or damage.

9. **Mount the unit in such locations, where no vibration or shock is affected.**

This may cause a malfunction or damage.

10. **Do not use in places where there are cyclic temperature changes.**

In case that the cyclic temperature is beyond normal temperature changes, the internal unit is likely to be adversely affected.

11. **Do not use in direct sunlight.**

Do not use in direct sunlight. It may cause a malfunction or damage.

12. **Use this product within the specified ambient temperature range.**

This may cause a malfunction.

13. **Do not use in places where there is radiated heat around it.**

Such a place is likely to cause a malfunction.



Series 10-S0700

Specific Product Precautions 10

Be sure to read this before handling.

Refer to page 1382 for Safety Instructions and pages 677 to 683 for 3/4/5 Port Solenoid Valve Precautions.

EX600

Adjustment/Operation

⚠ Warning

1. Do not perform operation or setting with wet hands.

There is a risk of electrical shock.

<Handheld Terminal>

2. Do not apply pressure to the LCD.

There is a possibility of the crack of LCD and injuring.

3. The forced input/output function is used to change the signal status forcibly. When operating this function, be sure to check the safety of the surroundings and installation.

Otherwise, injury or equipment damage could result.

4. Incorrect setting of parameters can cause malfunction. Be sure to check the settings before use.

This may cause injury or equipment damage.

⚠ Caution

1. Use a watchmakers' screwdriver with thin blade for the setting of each switch of the SI unit. When setting the switch, do not touch other unrelated parts.

This may cause parts damage or malfunction due to a short-circuit.

2. Provide adequate setting for the operating conditions.

Failure to do so could result in malfunction.

Refer to the operation manual for setting of the switches.

3. For details on programming and address setting, refer to the manual from the PLC manufacturer.

The content of programming related to protocol is designed by the manufacturer of the PLC used.

<Handheld Terminal>

4. Do not press the setting buttons with a sharp pointed object.

This may cause damage or malfunction.

5. Do not apply excessive load and impact to the setting buttons.

This may cause damage, equipment failure or malfunction.

When the order does not include the SI unit, the valve plate to connect the manifold and SI unit is not mounted. Use attached valve fixing screws and mount the valve plate.
(Tightening torque: 0.6 to 0.7 N·m)

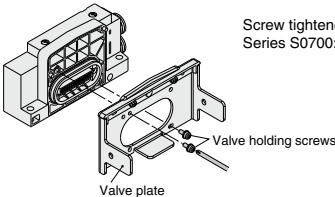

Maintenance

⚠ Warning

1. Do not disassemble, modify (including circuit board replacement) or repair this product.

Such actions are likely to cause injuries or breakage.

2. When an inspection is performed,

- Turn off the power supply.
- Stop the air supply, exhaust the residual pressure in piping and verify that the air is released before performing maintenance work.

Unexpected malfunction of system components and injury can result.

⚠ Caution

1. When handling and replacing the unit:

- Do not touch the sharp metal parts of the connector or plug.

- Do not apply excessive force to the unit when disassembling.

The connecting portions of the unit are firmly joined with seals.

- When joining units, take care not to get fingers caught between units.

Injury can result.

2. Perform periodic inspection.

Unexpected malfunction in the system composition devices is likely to occur due to malfunction of machinery or equipment.

3. After maintenance, make sure to perform an appropriate functionality inspection.

In cases of abnormality such as faulty operation, stop operation. Unexpected malfunction in the system composition devices is likely to occur.

4. Do not use benzene and thinner for cleaning units.

Damage to the surface or erasure of the display can result. Wipe off any stains with a soft cloth.

If the stain is persistent, wipe off with a cloth soaked in a dilute solution of neutral detergent and wrung out tightly, and then finish with a dry cloth.

Directional Control Valves

Air Cylinders

Rotary Actuators

Air Grippers

Air Preparation Equipment

Modular F. R.

Pressure Control Equipment

Fittings & Tubing

Flow Control Equipment

Pressure Switches/Pressure Sensors

■ Trademark

DeviceNet® is a registered trademark of ODVA, Inc. EtherNet/IP® is a registered trademark of ODVA, Inc. EtherCAT® is registered trademark and patented technology, licensed by Beckhoff Automation GmbH, Germany. The product names stated in this catalog may be trademarks of their respective owners.

