

# Series 10-SZ3000 5 Port Solenoid Valve Cassette Type Manifold

## Series 10-SZ3000 / Plug-in Type



Model		D-sub connector Type 60F	Flat ribbon cable type 60P□		
			Type 60P	Type 60PG	Type 60PH
<b>Manifold</b>		Plug-in type			
1 (P: SUP), 3/5 (R: EXH)		Common SUP, EXH			
Valve stations (With power terminal)		2 to 20 stations		2 to 16 stations	2 to 8 stations
<b>Applicable connector</b>		D-sub connector Conforming to MIL-C-24308 JIS-X-5101	Flat ribbon cable connector Socket: 26 pin MIL type with strain relief Conforming to MIL-C-83503	Flat ribbon cable connector Socket: 20 pin MIL type with strain relief Conforming to MIL-C-83503	Flat ribbon cable connector Socket: 10 pin MIL type with strain relief Conforming to MIL-C-83503
<b>Internal wiring</b>		+COM, -COM			
4(A), 2(B) port	Location	Valve			
	Porting specifications	Direction			
		Lateral, Upward, Downward			
<b>Port size</b>	Metric	1(P), 3/5(R) port: ø8		4(A), 2(B) port: M5, ø4, ø6	
	Inch	1(P), 3/5(R) port: ø5/16"		4(A), 2(B) port: ø5/32", ø1/4"	

## Series 10-SZ3000 / Non Plug-in Type



Model		Type 10-SS5Z3-60			
<b>Manifold</b>		Non plug-in type			
1 (P: SUP), 3/5 (R: EXH)		Common SUP, EXH			
Valve stations		2 to 20 stations			
4(A), 2(B) port	Location	Valve			
	Porting specifications	Direction			
		Lateral, Upward, Downward			
<b>Port size</b>	Metric	1(P), 3/5(R) port: ø8		4(A), 2(B) port: M5, ø4, ø6	
	Inch	1(P), 3/5(R) port: ø5/16"		4(A), 2(B) port: ø5/32", ø1/4"	

## Series 10-SZ3000 / Serial Transmission Type



Protocol type	CE-compliant
NKE Corp.: Fieldbus System	—
NKE Corp.: Fieldbus H System	—
Panasonic Industrial Devices SUNX Co., Ltd.: S-LINK (16 outputs)	—
Panasonic Industrial Devices SUNX Co., Ltd.: S-LINK (8 outputs)	—
DeviceNet®	○
OMRON Corp.: CompoBus/S (16 outputs)	○
OMRON Corp.: CompoBus/S (8 outputs)	○
CC-Link	○

# Series 10-SZ3000

5 Port Solenoid Valve  
Plug-in Type



## How to Order

An order cannot be placed with only the manifold part no. Be sure to order solenoid valves for mounting at the same time while referring to the ordering example.

### • Plug-in manifold with power supply terminal

**10-SS5Z3-60 F D 1 - 05 U - P - - -**

• Clean series

• CE-compliant

Nil	—
Q	CE-compliant

#### • Connector type

**F:** D-sub connector (25 pins)

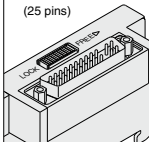

**P:** Flat ribbon cable (26 pins)

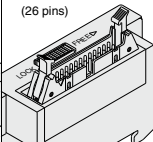

**PG:** Flat ribbon cable (20 pins)

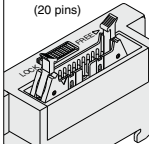

**PH:** Flat ribbon cable (10 pins)

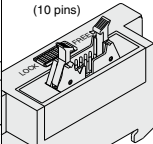

#### SUP/EXH block mounting position

<b>U</b>	U side (2 to 10 stations)
<b>D</b>	D side (2 to 10 stations)
<b>B</b>	Both sides (2 to 20 stations)
<b>M*</b>	Special specifications

\* For special specifications, indicate separately with the manifold specification sheet.  
Note) A total of up to 3 SUP/EXH blocks can be mounted. Please contact SMC if 4 or more will be mounted.

#### • Option

When a longer DIN rail is desired than the specified stations, specify the station number to be required.

#### • Power supply terminal

Symbol	Specifications
<b>P</b>	24 VDC, Positive common
<b>P12</b>	12 VDC, Positive common
<b>N</b>	24 VDC, Negative common
<b>N12</b>	12 VDC, Negative common

#### • SUP/EXH block fitting type

Nil	Straight
<b>L</b>	Elbow (Upward)
<b>B</b>	Elbow (Downward)

#### • Pilot type

Nil	Internal pilot
<b>R</b>	External pilot

#### • Valve stations

**F:** D-sub connector

Symbol	Stations	Note
<b>02</b>	2 stations	Double wiring <sup>Note 1)</sup>
∴	∴	
<b>10</b>	10 stations	Specified layout <sup>Note 2)</sup> (Up to 21 solenoids possible)
<b>02</b>	2 stations	
∴	∴	
<b>20</b>	20 stations	

**P:** Flat ribbon cable connector (26 pins)

Symbol	Stations	Note
<b>02</b>	2 stations	Double wiring
∴	∴	
<b>11</b>	11 stations	Specified layout (Up to 22 solenoids possible)
<b>02</b>	2 stations	
∴	∴	
<b>20</b>	20 stations	

#### • Connector mounting position

Symbol	Mounting position
<b>D</b>	D side

#### • Connector entry direction

**1:** Perpendicular connector    **2:** Lateral connector

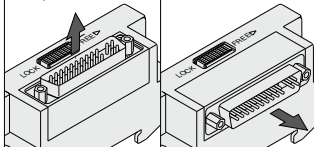

**PG:** Flat ribbon cable connector (20 pins)

Symbol	Stations	Note
<b>02</b>	2 stations	Double wiring
∴	∴	
<b>08</b>	8 stations	Specified layout (Up to 16 solenoids possible)
<b>02</b>	2 stations	
∴	∴	
<b>16</b>	16 stations	

**PH:** Flat ribbon cable connector (10 pins)

Symbol	Stations	Note
<b>02</b>	2 stations	Double wiring
∴	∴	
<b>04</b>	4 stations	Specified layout (Up to 8 solenoids possible)
<b>02</b>	2 stations	
∴	∴	
<b>08</b>	8 stations	

Note 1) Double wiring: Single, double, 3 position and 4 position solenoid valves can be used at all of the manifold stations.

Note 2) Specified layout: Indicate wiring specifications on the manifold specification sheet.

(Note that double, 3 position and 4 position valves cannot be used where single solenoid wiring has been specified.)

Directional Control Valves

Air Cylinders

Rotary Actuators

Air Grippers

Air Preparation Equipment

Modular F. R.

Pressure Control Equipment

Fittings & Tubing

Flow Control Equipment

Pressure Switches/ Pressure Sensors



An order cannot be placed with only the manifold part no. Be sure to order solenoid valves for mounting at the same time while referring to the ordering example.

## How to Order

### • Plug-in manifold without power supply terminal

**10-SS5Z3-60 F D 1 - 05 U** [ ] [ ] - [ ] - [ ]

• Clean series

• CE-compliant

Nil	—
Q	CE-compliant

#### • Connector type

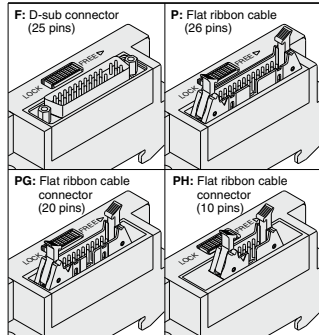

#### • SUP/EXH block mounting position

<b>U</b>	U side (2 to 10 stations)
<b>D</b>	D side (2 to 10 stations)
<b>B</b>	Both sides (2 to 20 stations)
<b>M</b> *	Special specifications

\* For special specifications, indicate separately with the manifold specification sheet.  
 (Note) A total of up to 3 SUP/EXH blocks can be mounted. Please contact SMC if 4 or more will be mounted.

• Option

When a longer DIN rail is desired than the specified stations, specify the station number to be required.

#### • SUP/EXH block fitting type

<b>Nil</b>	Straight
<b>L</b>	Elbow (Upward)
<b>B</b>	Elbow (Downward)

#### • Pilot type

<b>Nil</b>	Internal pilot
<b>R</b>	External pilot

#### • Valve stations

#### • Connector mounting position

Symbol	Mounting position
<b>D</b>	D side

#### • Connector entry direction

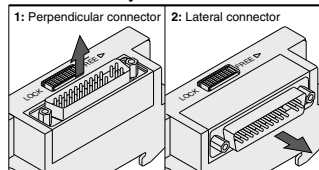

#### F: D-sub connector

Symbol	Stations	Note
<b>02</b>	2 stations	Double wiring <sup>Note 1)</sup>
⋮	⋮	
<b>12</b>	12 stations	Specified layout <sup>Note 2)</sup> (Up to 24 solenoids possible)
⋮	⋮	
<b>20</b>	20 stations	

#### P: Flat ribbon cable connector (26 pins)

Symbol	Stations	Note
<b>02</b>	2 stations	Double wiring
⋮	⋮	
<b>12</b>	12 stations	Specified layout (Up to 25 solenoids possible)
⋮	⋮	
<b>20</b>	20 stations	

#### PG: Flat ribbon cable connector (20 pins)

Symbol	Stations	Note
<b>02</b>	2 stations	Double wiring
⋮	⋮	
<b>09</b>	9 stations	Specified layout (Up to 19 solenoids possible)
⋮	⋮	
<b>19</b>	19 stations	

#### PH: Flat ribbon cable connector (10 pins)

Symbol	Stations	Note
<b>02</b>	2 stations	Double wiring
⋮	⋮	
<b>04</b>	4 stations	Specified layout (Up to 9 solenoids possible)
⋮	⋮	
<b>09</b>	9 stations	

Note 1) Double wiring: Single, double, 3 position and 4 position solenoid valves can be used at all of the manifold stations.

Note 2) Specified layout: Indicate wiring specifications on the manifold specification sheet.

(Note that double, 3 position and 4 position valves cannot be used where single solenoid wiring has been specified.)



How to Order

• How to order solenoid valve For plug-in (Common for both with and without power supply terminals)

10 - SZ3 1 60 - 5 LOZ - C6 -

• Clean series

Actuation type

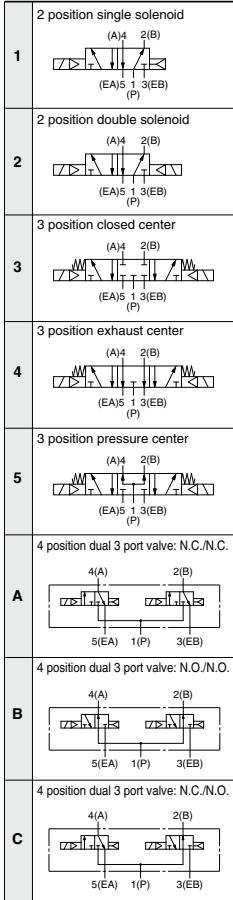

Rated voltage

5	24 VDC
6	12 VDC

• When using on a manifold with power supply terminals, be sure to match with the manifold's voltage specifications.

Back pressure check valve

Nil	None
K	Built-in

• The built-in back pressure check valve type has an effective area approximately 20% smaller.  
 • The product with back pressure check valve is not available for 3 position solenoid valves.

Pilot type

Nil	Internal pilot
R	External pilot

• External pilot specifications are not available for 4 position dual 3 port valves.

Switch

Nil: Without switch

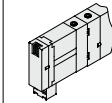

J: With switch

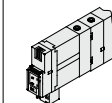

\* For switch operation, refer to page 412.

Common specifications

Nil	Positive common
N	Negative common

• When using on a manifold with power supply terminals, be sure to match with the manifold's common specifications.

Manual override

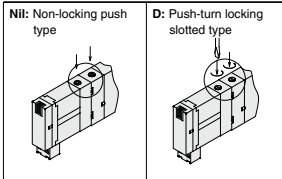

CE-compliant

Nil	-
Q	CE-compliant

A, B port size

C4: ø4 One-touch fitting  
 C6: ø6 One-touch fitting  
 N3: ø5/32" One-touch fitting  
 N7: ø1/4" One-touch fitting



M5: M5 x 0.8



Elbow fitting assembly (Upward)

L4: ø4 elbow fitting assembly  
 L6: ø6 elbow fitting assembly



Elbow fitting assembly (Downward)

B4: ø4 elbow fitting assembly  
 B6: ø6 elbow fitting assembly

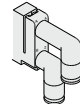

Directional Control Valves

Air Cylinders

Rotary Actuators

Air Grippers

Air Preparation Equipment

Modular F. R.

Pressure Control Equipment

Fittings & Tubing

Flow Control Equipment

Pressure Switches/ Pressure Sensors

## How to Order Valve Manifold Assembly

Ordering example (10-SZ3000, positive common with power supply terminals)

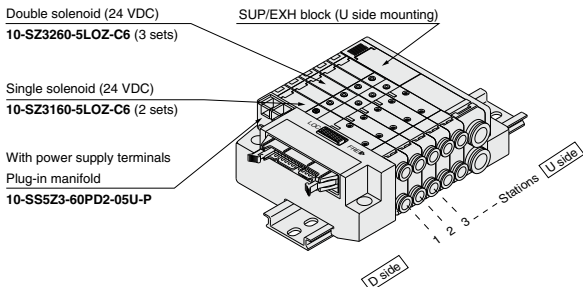

10-SS5Z3-60PD2-05U-P ..... 1 set (Manifold part no.)  
 \* 10-SZ3160-5LOZ-C6 ..... 2 sets (Single solenoid part no.)  
 \* 10-SZ3260-5LOZ-C6 ..... 3 sets (Double solenoid part no.)

The asterisk denotes the symbol for assembly.  
 Prefix to the part no. of the solenoid valve, etc.

Stations are counted from the D side as the 1st one.  
 Add the valve part number under the manifold part number.  
 For complex arrangements, specify them on the manifold specification sheet.



**Made to Order**  
 (For details, refer to page 411.)

## Manifold Specifications

Model	D-sub connector Type 60F	Flat ribbon cable type 60P□		
		Type 60P	Type 60PG	Type 60PH
<b>Manifold</b>	Plug-in type			
<b>1 (P: SUP), 3/5 (R: EXH)</b>	Common SUP, EXH			
<b>Valve stations (With power terminal)</b>	2 to 20 stations	2 to 16 stations	2 to 8 stations	
<b>Applicable connector</b>	D-sub connector Conforming to MIL-C-24308 JIS-X-5101	Flat ribbon cable connector Socket: 26 pin MIL type with strain relief Conforming to MIL-C-83503	Flat ribbon cable connector Socket: 20 pin MIL type with strain relief Conforming to MIL-C-83503	Flat ribbon cable connector Socket: 10 pin MIL type with strain relief Conforming to MIL-C-83503
<b>Internal wiring</b>	+COM, -COM			
<b>4(A), 2(B) port</b>	<b>Location</b>	Valve		
<b>Porting specifications</b>	<b>Direction</b>	Lateral, Upward, Downward		
<b>Port size</b>	<b>Metric</b>	1(P), 3/5(R) port: ø8	4(A), 2(B) port: M5, ø4, ø6	
	<b>Inch</b>	1(P), 3/5(R) port: ø5/16"	4(A), 2(B) port: ø5/32", ø1/4"	
<b>Weight W (g)</b> <sup>Note 2)</sup> (n1: Stations n2: Number of SUP/EXH blocks m: Weight of DIN rail)	W = 3.2n1 + 53n2 + m + 126.5			

Note 1) In cases such as those where many valves are operated simultaneously, use type B (double side SUP/EXH), applying pressure to the 1(P) ports on both sides and exhausting from the 3(R) ports on both sides.

Note 2) The weight W is the value for the D-sub connector manifold with power supply terminals only. To obtain the weight with solenoid valves attached, add the solenoid valve weights given on page 382 for the appropriate number of stations. For DIN rail weight, refer to page 384.

## Flow Rate Characteristics

Port size		Flow rate characteristics					
1, 5, 3 (P, EA, EB)	4, 2 (A, B)	1 → 2/4 (P → A/B)			4/2 → (A/B → R)		
		C [dm <sup>3</sup> /(s·bar)]	b	Cv	C [dm <sup>3</sup> /(s·bar)]	b	Cv
C8	C4	0.58 [0.49]	0.26 [0.36]	0.14 [0.13]	0.76 [0.65]	0.15 [0.20]	0.18 [0.15]
	C6	0.73 [0.64]	0.24 [0.27]	0.18 [0.16]	0.77 [0.74]	0.19 [0.16]	0.19 [0.19]
	M5	0.60 [0.57]	0.38 [0.35]	0.17 [0.15]	0.67 [0.58]	0.16 [0.39]	0.16 [0.16]

Note) - The values are for individually operated 2 position type manifold bases with 5 stations.

- Values inside [ ] are for 4 position dual 3 port valves.

### Solenoid Valve Specifications

Series		<b>10-SZ3000</b>	
Fluid		Air	
Internal pilot operating pressure range (MPa)	2 position single	0.15 to 0.7	
	2 position double	0.1 to 0.7	
	3 position	0.2 to 0.7	
	4 position dual 3 port valve	0.15 to 0.7	
Operating pressure range		-100 kPa to 0.7	
External pilot operating pressure range (MPa)	Pilot pressure range	2 position single	0.25 to 0.7
		2 position double	0.25 to 0.7
		3 position	0.25 to 0.7
Ambient and fluid temperature (°C)		-10 to 50 (No freezing. Refer to page 680.)	
Max. operating frequency (Hz)	2 position single, double	10	
	4 position dual 3 port valve		
	3 position	3	
Manual override (Manual operation)		Non-locking push type, Push-turn locking slotted type	
Pilot type		Main/Pilot valve common exhaust	
Lubrication		Not required	
Mounting orientation		Unrestricted	
Impact/Vibration resistance (m/s <sup>2</sup> ) <sup>(Note)</sup>		150/30	
Enclosure		Dust proof	

Note) Impact resistance: No malfunction occurred when it was tested with a drop tester in the axial direction and at right angles to the main valve and armature in both energized and de-energized states once for each condition. (Default settings)

Vibration resistance: No malfunction occurred in a one-sweep test between 45 and 2000 Hz. Test was performed in both energized and de-energized states in the axial direction and at right angles to the main valve and armature. (Default settings)

### Solenoid Specifications

Electrical entry	L type (For plug-in), M type plug connector (M)
Coil rated voltage (V) <sup>(Note)</sup>	24, 12 VDC
Allowable voltage fluctuation	±10% of rated voltage
Power consumption (W)	0.6 (With light: 0.65)
Surge voltage suppressor	Diode
Indicator light	LED

### Response Time

Note) Based on dynamic performance test, JIS B 8375-1981. (Coil temperature: 20°C, at rated voltage)

Actuation type	Response time (ms) (at the pressure of 0.5 MPa)	
	Without surge voltage suppressor	With surge voltage suppressor S, Z type
2 position single	12 or less	15 or less
2 position double	10 or less	13 or less
3 position	15 or less	20 or less
4 position dual 3 port valve	30 or less	35 or less

### Weight

Valve model	Actuation type		Port size	Weight (g)
			4(A), 2(B)	
10-SZ3□60□□-□- <b>C4</b> N3	2 position	Single	C4 N3 (One-touch fitting)	78
		Double		84
	3 position	Closed center		88
		Exhaust center		
		Pressure center		
	4 position	Dual 3 port valve		84
10-SZ3□60□□-□- <b>C6</b> N7	2 position	Single	C6 N7 (One-touch fitting)	74
		Double		81
	3 position	Closed center		85
		Exhaust center		
		Pressure center		
	4 position	Dual 3 port valve		81
10-SZ3□60□□-□- <b>M5</b>	2 position	Single	M5 x 0.8	69
		Double		75
	3 position	Closed center		79
		Exhaust center		
		Pressure center		
	4 position	Dual 3 port valve		75

Directional Control Valves  
 Air Cylinders  
 Rotary Actuators  
 Air Grippers  
 Air Preparation Equipment  
 Modular F. R.  
 Pressure Control Equipment  
 Fittings & Tubing  
 Flow Control Equipment  
 Pressure Switches/ Pressure Sensors

## Manifold Option

### ■SUP block disk

By installing a SUP block disk in the pressure supply passage of a manifold valve, it is possible to supply two or more different high and low pressures to one manifold. (Use in combination with a pilot port block disk.)



Series	Part no.
<b>10-SZ3000</b>	SZ3000-114-4A

### ■EXH block disk

By installing an EXH block disk in the exhaust passage of a manifold valve, it is possible to divide the valve's exhaust so that it does not affect another valve. (Two block disks are needed to divide both exhausts.)



Series	Part no.
<b>10-SZ3000</b>	SZ3000-114-4A

### ■Pilot port block disk

By installing a pilot port block disk in the pilot passage of a manifold valve, it can be function as an internal pilot/external pilot mixed manifold. (Use in combination with a SUP or EXH block disk.)



Series	Part no.
<b>10-SZ3000</b>	SZ3000-114-2A

### ■Blanking block assembly SZ3000-55-1A

These are mounted when later addition of valves is planned, etc.

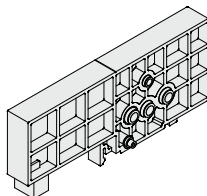

### ■Plug (White)

These are inserted in unused cylinder ports or SUP/EXH ports. Purchase orders are available in units of 10 pieces.

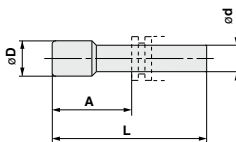

### Dimensions

Applicable fitting size $\phi d$	Model	A	L	D
4	<b>10-KQP-04</b>	16	32	$\phi 6$
6	<b>10-KQP-06</b>	18	35	$\phi 8$
8	<b>10-KQP-08</b>	20.5	39	$\phi 10$

## Manifold Option

### ■DIN rail dimensions / Weight

VZ1000-11-1-□

Refer to the L dimension tables  
\* Enter a number from the DIN rail dimension table below.

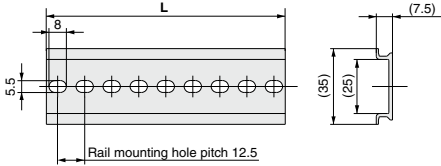

No.	0	1	2	3	4	5	6	7	8	9
L dimension	98	110.5	123	135.5	148	160.5	173	185.5	198	210.5
Weight (g)	17.6	19.9	22.1	24.4	26.6	28.9	31.1	33.4	35.6	37.9

No.	10	11	12	13	14	15	16	17	18	19
L dimension	223	235.5	248	260.5	273	285.5	298	310.5	323	335.5
Weight (g)	40.1	42.4	44.6	46.9	49.1	51.4	53.6	55.9	58.1	60.4

### ■Flat ribbon cable type / Cable assembly

AXT100-FC□-to-3

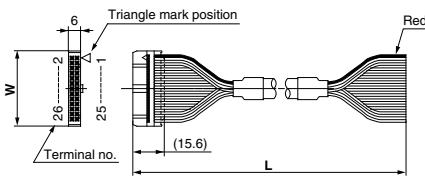

#### Flat Ribbon Cable Assembly

Cable length (L)	10 pins	20 pins	26 pins
1.5 m	AXT100-FC10-1	AXT100-FC20-1	AXT100-FC26-1
3 m	AXT100-FC10-2	AXT100-FC20-2	AXT100-FC26-2
5 m	AXT100-FC10-3	AXT100-FC20-3	AXT100-FC26-3
Connector width (W)	17.2	30	37.5

\* For other commercial connectors, use a type with strain relief conforming to MIL-C-83503.

#### Example of connector manufacturers

- HIROSE ELECTRIC CO., LTD.
- Japan Aviation Electronics Industry, Limited
- 3M Japan Limited
- J.S.T. Mfg. Co., Ltd.
- Fujitsu Limited

### ■D-sub connector (25 pins) / Cable assembly

AXT100-DS25-015  
030  
050

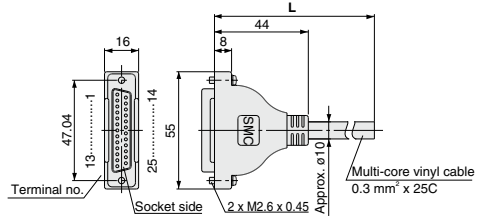

#### D-sub Connector Cable Assembly Terminal No.

Terminal no.	Lead wire color	Dot marking
1	Black	None
2	Brown	None
3	Red	None
4	Orange	None
5	Yellow	None
6	Pink	None
7	Blue	None
8	Purple	White
9	Gray	Black
10	White	Black
11	White	Red
12	Yellow	Red
13	Orange	Red
14	Yellow	Black
15	Pink	Black
16	Blue	White
17	Purple	None
18	Gray	None
19	Orange	Black
20	Red	White
21	Brown	White
22	Pink	Red
23	Gray	Red
24	Black	White
25	White	None

#### D-sub Connector Cable Assembly

Cable length (L)	Assembly part no.	Note
1.5 m	AXT100-DS25-015	Cable 25 cores x 24AWG
3 m	AXT100-DS25-030	
5 m	AXT100-DS25-050	

\* For other commercial connectors, use a 25 pin type with female connector conforming to MIL-C-24308.

#### Example of connector manufacturers

- HIROSE ELECTRIC CO., LTD.
- Japan Aviation Electronics Industry, Limited
- J.S.T. Mfg. Co., Ltd.
- Fujitsu Limited

#### Electric Characteristics

Item	Characteristics
Conductor resistance Ω/km, 20°C	65 or less
Withstand limit VAC, 1 minute	1000
Insulation resistance MΩ/km, 20°C	5 or less

(Note) The minimum bending radius of the D-sub connector cable is 20 mm.

Directional Control Valves

Air Cylinders

Rotary Actuators

Air Grippers

Air Preparation Equipment

Modular F. R.

Pressure Control Equipment

Fittings & Tubing

Flow Control Equipment

Pressure Switches/ Pressure Sensors



## Manifold Electrical Wiring

### Type 60F D-sub Connector Type (25 pins)

#### ● Without Power Supply Terminal

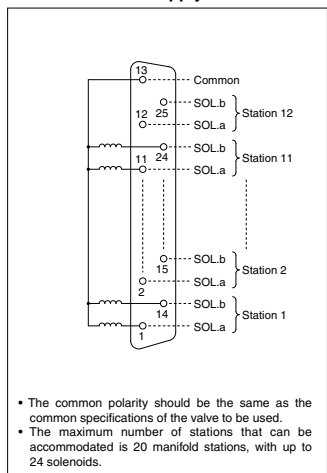

- The common polarity should be the same as the common specifications of the valve to be used.
- The maximum number of stations that can be accommodated is 20 manifold stations, with up to 24 solenoids.
- The circuits above are for the double wiring specification with up to 10 or 12 stations. Connect to SOL.A for a single solenoid. Moreover, when wiring instructions are given on the manifold specification sheet, the "A" signal for single and the "A, B" signals for double should be wired in order 1, 14, 2, 15.....etc., without skipping or leaving any connectors remaining.
- Stations are counted from the D side as the 1st one.

#### ● With Power Supply Terminal

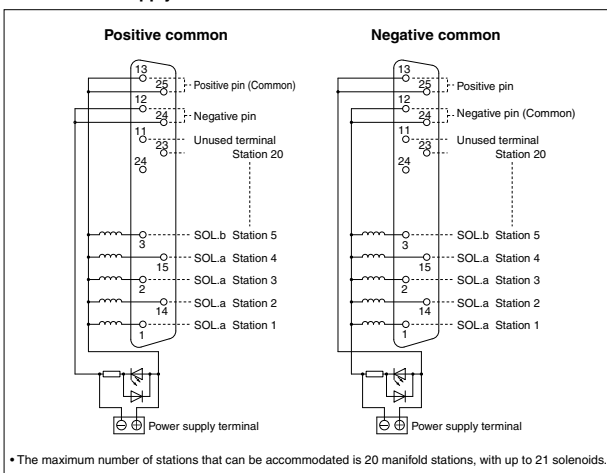

- The maximum number of stations that can be accommodated is 20 manifold stations, with up to 21 solenoids.

### Type 60P Flat Ribbon Cable Type (26 pins)

#### ● Without Power Supply Terminal

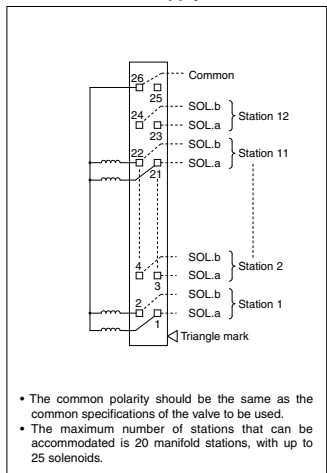

- The common polarity should be the same as the common specifications of the valve to be used.
- The maximum number of stations that can be accommodated is 20 manifold stations, with up to 25 solenoids.
- The circuits above are for the double wiring specification with up to 11 or 12 stations. Connect to SOL.A for a single solenoid. Moreover, when wiring instructions are given on the manifold specification sheet, the "A" signal for single and the "A, B" signals for double should be wired in order 1, 2, 3, 4.....etc., without skipping or leaving any connectors remaining.
- Stations are counted from the D side as the 1st one.
- Since terminal numbers are not indicated on the flat cable, use the triangle mark as a reference for wiring.

#### ● With Power Supply Terminal

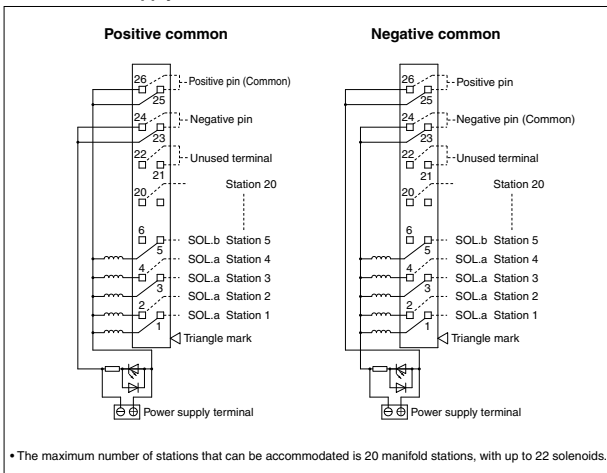

- The maximum number of stations that can be accommodated is 20 manifold stations, with up to 22 solenoids.

## Manifold Electrical Wiring

### Type 60PG Flat Ribbon Cable Type (20 pins)

#### ● Without Power Supply Terminal

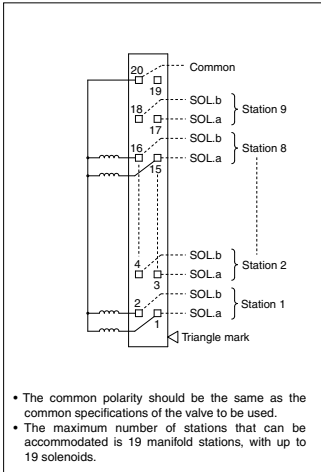

- The common polarity should be the same as the common specifications of the valve to be used.
- The maximum number of stations that can be accommodated is 19 manifold stations, with up to 19 solenoids.

#### ● With Power Supply Terminal

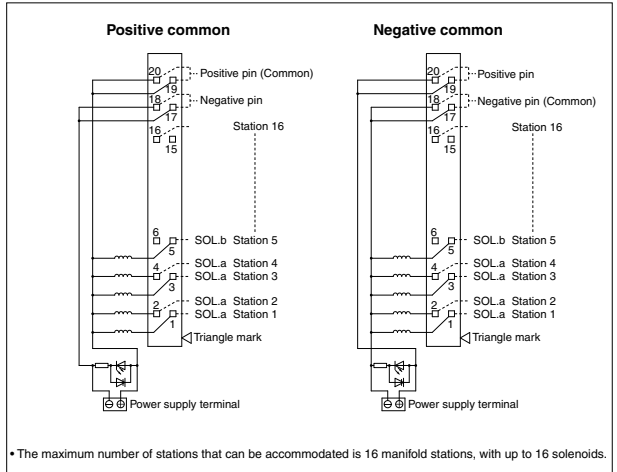

- The maximum number of stations that can be accommodated is 16 manifold stations, with up to 16 solenoids.

- The circuits above are for the double wiring specification with up to 8 or 9 stations. Connect to SOL.A for a single solenoid. Moreover, when wiring instructions are given on the manifold specification sheet, the "A" signal for single and the "A, B" signals for double should be wired in order 1, 2, 3, 4.....etc., without skipping or leaving any connectors remaining.
- Stations are counted from the D side as the 1st one.
- Since terminal numbers are not indicated on the flat cable, use the triangle mark as a reference for wiring.

### Type 60PH Flat Ribbon Cable Type (10 pins)

#### ● Without Power Supply Terminal

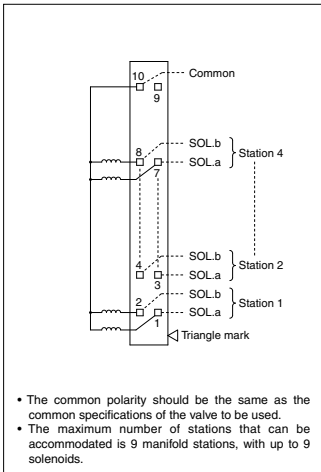

- The common polarity should be the same as the common specifications of the valve to be used.
- The maximum number of stations that can be accommodated is 9 manifold stations, with up to 9 solenoids.

#### ● With Power Supply Terminal

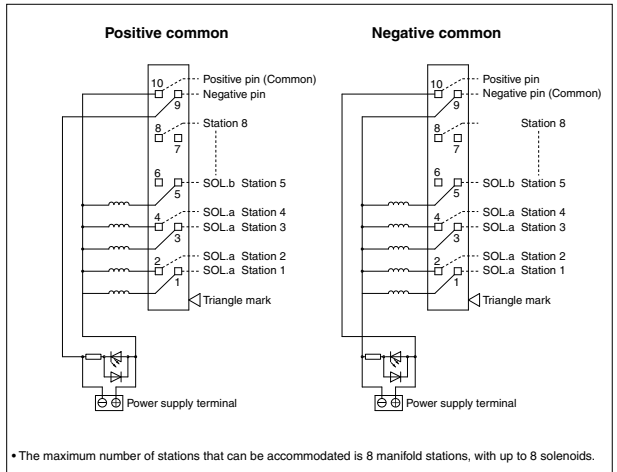

- The maximum number of stations that can be accommodated is 8 manifold stations, with up to 8 solenoids.

- The circuits above are for the double wiring specification with up to 4 stations. Connect to SOL.A for a single solenoid. Moreover, when wiring instructions are given on the manifold specification sheet, the "A" signal for single and the "A, B" signals for double should be wired in order 1, 2, 3, 4.....etc., without skipping or leaving any connectors remaining.
- Stations are counted from the D side as the 1st one.
- Since terminal numbers are not indicated on the flat cable, use the triangle mark as a reference for wiring.

Directional Control Valves

Air Cylinders

Rotary Actuators

Air Grippers

Air Preparation Equipment

Modular F. R.

Pressure Control Equipment

Fittings & Tubing

Flow Control Equipment

Pressure Switches/ Pressure Sensors

## Wiring of Plug-in Type Manifold with Power Supply Terminal (Example)

- Since the power supply to drive valves with power supply terminals can be supplied from either the control side or the manifold side, these wiring examples should be used for reference when wiring is performed.

### 1. Wiring example when using manifold power supply terminal

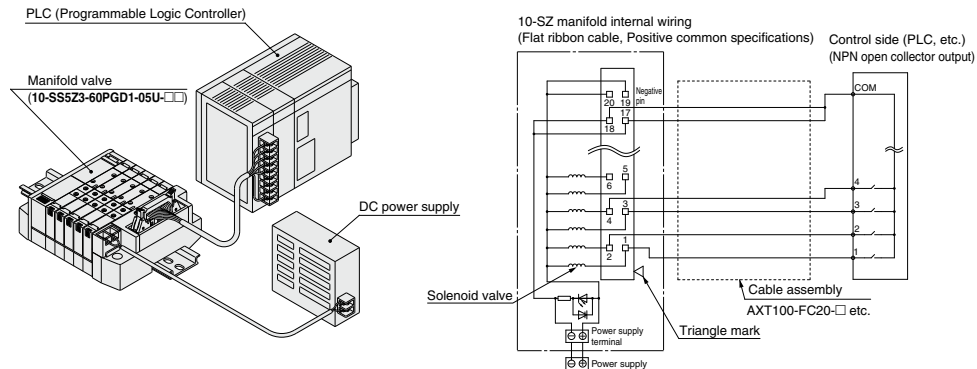

### 2. Wiring example when not using manifold power supply terminal (Power is supplied to the control side or along the wiring, etc.)

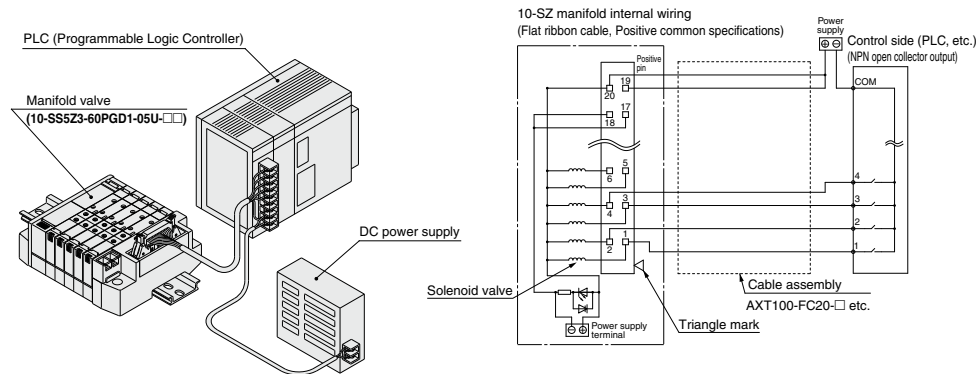

### ⚠ Caution

- Signal wire, COM position, etc. of PLC are different from each manufacturer. When connecting with PLC, read the specifications carefully and understand the electrical circuit. Poor wiring could cause damage to PLC, power source, etc. as well as manifold and valve.

**Dimensions: 10-SZ3000 for Plug-in**

**10-SS5Z3-60FD<sub>1</sub> - [Stations] U-□**

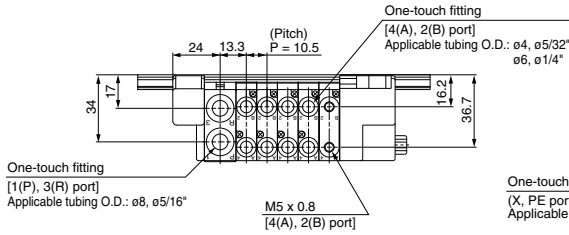

**[With External Pilot Specifications]**

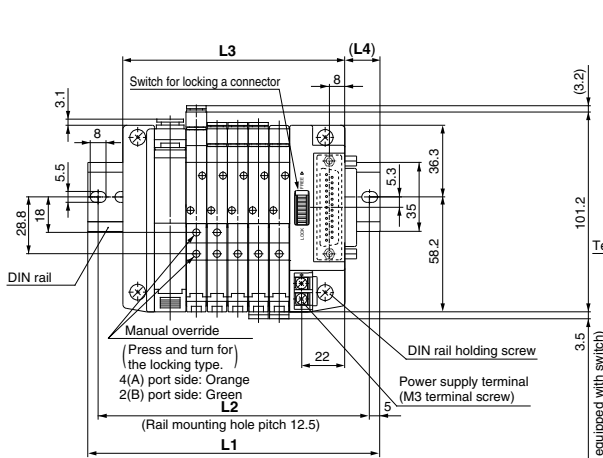
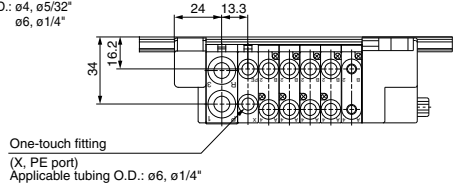

Applicable D-sub connector: {JIS-X-5101 / MIL-C-24308} equivalent

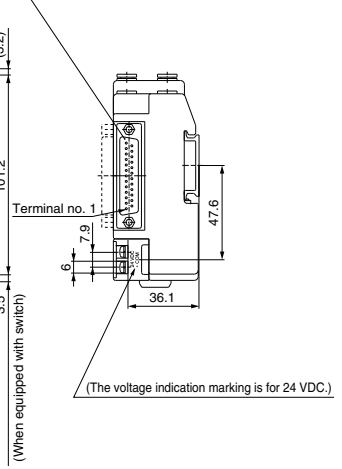

(Station n) ..... (Station 1)

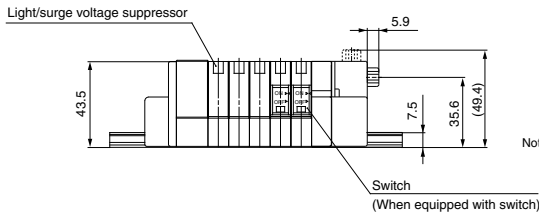

Note) For manifold dimensions with elbow fitting, refer to page 392.

Internal Pilot Manifold		L Dimension										n: Stations							
n	2	3	4	5	6	7	8	9	10										
L1	110.5	123	135.5	148	148	160.5	173	185.5	198										
L2	100	112.5	125	137.5	137.5	150	162.5	175	187.5										
L3	81	91.5	102	112.5	123	133.5	144	154.5	165										
L4	15	16	17	18	12.5	13.5	14.5	15.5	16.5										

External Pilot Manifold		L Dimension										n: Stations							
n	2	3	4	5	6	7	8	9	10										
L1	123	135.5	148	148	160.5	173	185.5	198	210.5										
L2	112.5	125	137.5	137.5	150	162.5	175	187.5	200										
L3	91.5	102	112.5	123	133.5	144	154.5	165	175.5										
L4	16	17	18	12.5	13.5	14.5	15.5	16.5	17.5										

Directional Control Valves  
 Air Cylinders  
 Rotary Actuators  
 Air Grippers  
 Air Preparation Equipment  
 Modular F. R.  
 Pressure Control Equipment  
 Fittings & Tubing  
 Flow Control Equipment  
 Pressure Switches/ Pressure Sensors

**Dimensions: 10-SZ3000 for Plug-in**

**10-SS5Z3-60FD<sub>2</sub> - [Stations] B-□**

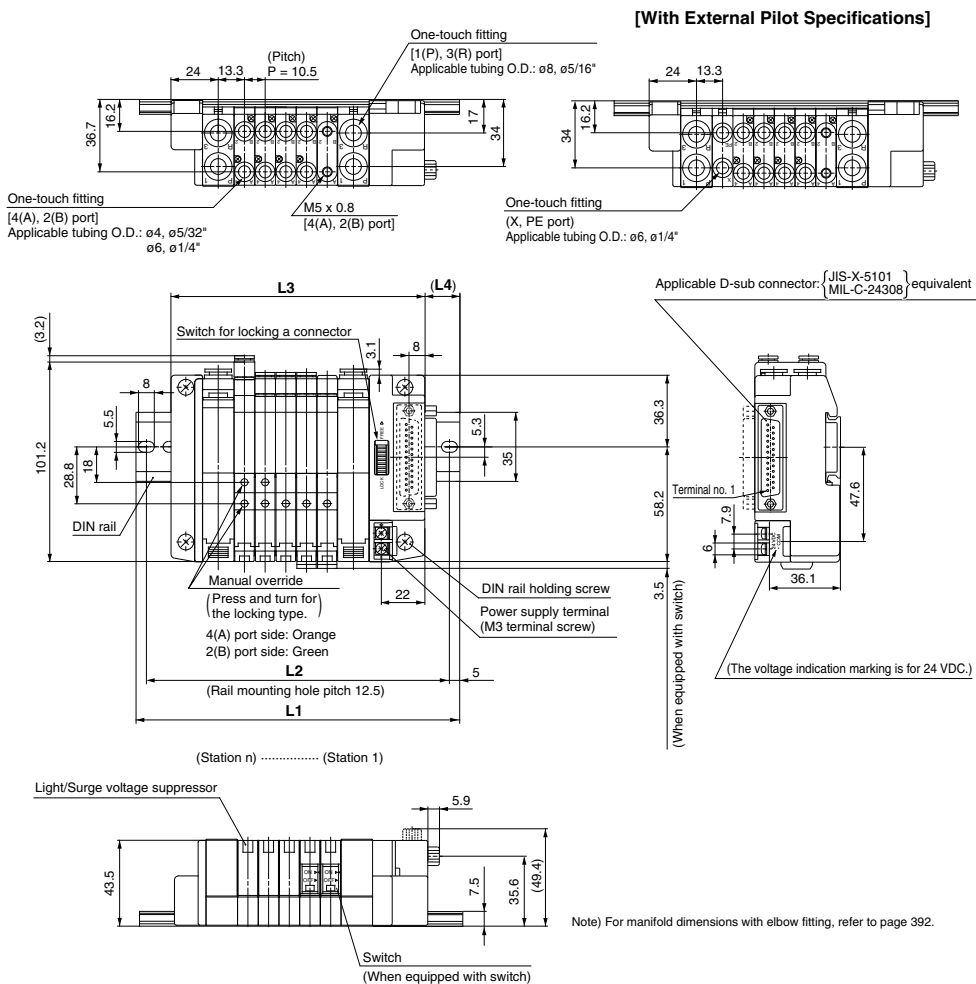

Note) For manifold dimensions with elbow fitting, refer to page 392.

**Internal Pilot Manifold L Dimension**

L	n	n: Stations																		
		2	3	4	5	6	7	8	9	10	11	12	13	14	15	16	17	18	19	20
L1	123	135.5	148	160.5	173	173	185.5	198	210.5	223	235.5	248	248	260.5	273	285.5	298	310.5	310.5	
L2	112.5	125	137.5	150	162.5	162.5	175	187.5	200	212.5	225	237.5	237.5	250	262.5	275	287.5	300	300	
L3	97	107.5	118	128.5	139	149.5	160	170.5	181	191.5	202	212.5	223	233.5	244	254.5	265	275.5	286	
L4	13	14	15	16	17	12	13	14	15	16	17	18	12.5	13.5	14.5	15.5	16.5	17.5	12.5	

**External Pilot Manifold L Dimension**

L	n	n: Stations																		
		2	3	4	5	6	7	8	9	10	11	12	13	14	15	16	17	18	19	20
L1	135.5	148	160.5	173	173	185.5	198	210.5	223	235.5	248	248	260.5	273	285.5	298	310.5	310.5	323	
L2	125	137.5	150	162.5	162.5	175	187.5	200	212.5	225	237.5	237.5	250	262.5	275	287.5	300	300	312.5	
L3	107.5	118	128.5	139	149.5	160	170.5	181	191.5	202	212.5	223	233.5	244	254.5	265	275.5	286	296.5	
L4	14	15	16	17	12	13	14	15	16	17	18	12.5	13.5	14.5	15.5	16.5	17.5	12.5	13.5	

**Dimensions: 10-SZ3000 for Plug-in**

**10-SS5Z3-60PD  $\frac{1}{2}$  - [Stations] U-□ (26 pins)**

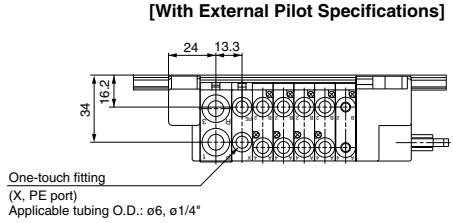
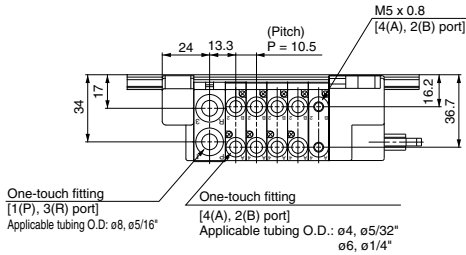

[With External Pilot Specifications]

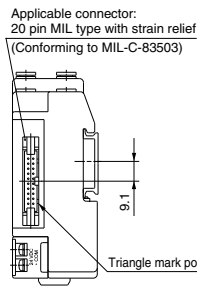
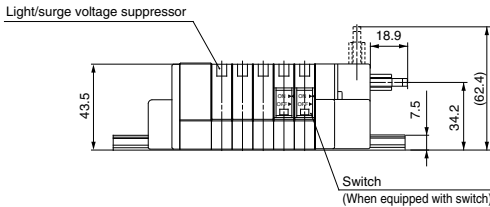
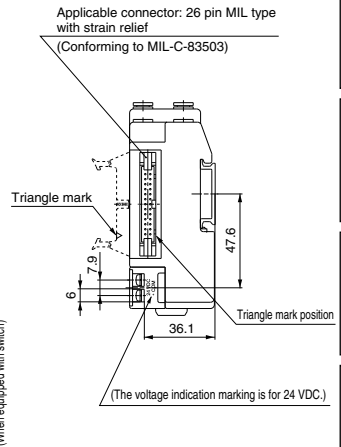
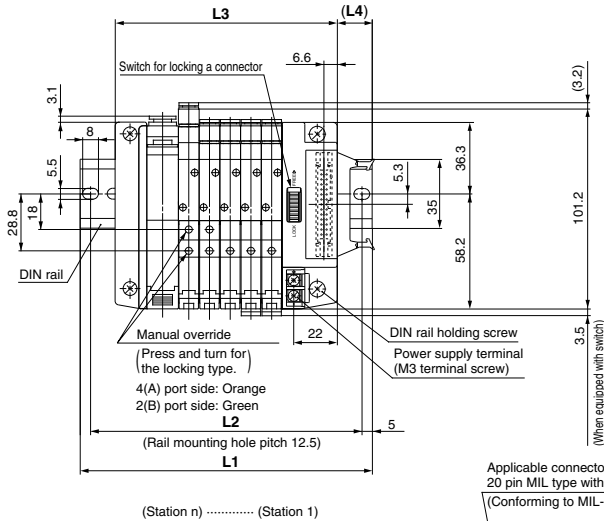

**60PG (20 pins)**

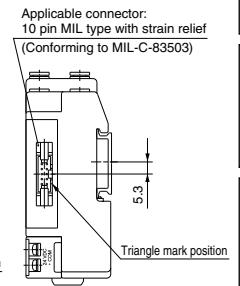

**60PH (10 pins)**

Note 1) Types 60PG and 60PH differ only in their connectors, and the L1 through L4 dimensions are the same as type 60P.  
 Note 2) For manifold dimensions with elbow fitting, refer to page 392.

Internal Pilot Manifold L Dimension										n: Stations
L	2	3	4	5	6	7	8	9	10	
L1	110.5	123	135.5	148	148	160.5	173	185.5	198	
L2	100	112.5	125	137.5	137.5	150	162.5	175	187.5	
L3	81	91.5	102	112.5	123	133.5	144	154.5	165	
L4	15	16	17	18	12.5	13.5	14.5	15.5	16.5	

External Pilot Manifold L Dimension										n: Stations
L	2	3	4	5	6	7	8	9	10	
L1	123	135.5	148	148	160.5	173	185.5	198	210.5	
L2	112.5	125	137.5	137.5	150	162.5	175	187.5	200	
L3	91.5	102	112.5	123	133.5	144	154.5	165	175.5	
L4	16	17	18	12.5	13.5	14.5	15.5	16.5	17.5	

Directional Control Valves  
 Air Cylinders  
 Rotary Actuators  
 Air Grippers  
 Air Preparation Equipment  
 Modular F. R.  
 Pressure Control Equipment  
 Fittings & Tubing  
 Flow Control Equipment  
 Pressure Switches/ Pressure Sensors

**Dimensions: 10-SZ3000 for Plug-in**

**10-SS5Z3-60PD 1/2 - [Stations] B-□ (26 pins)**

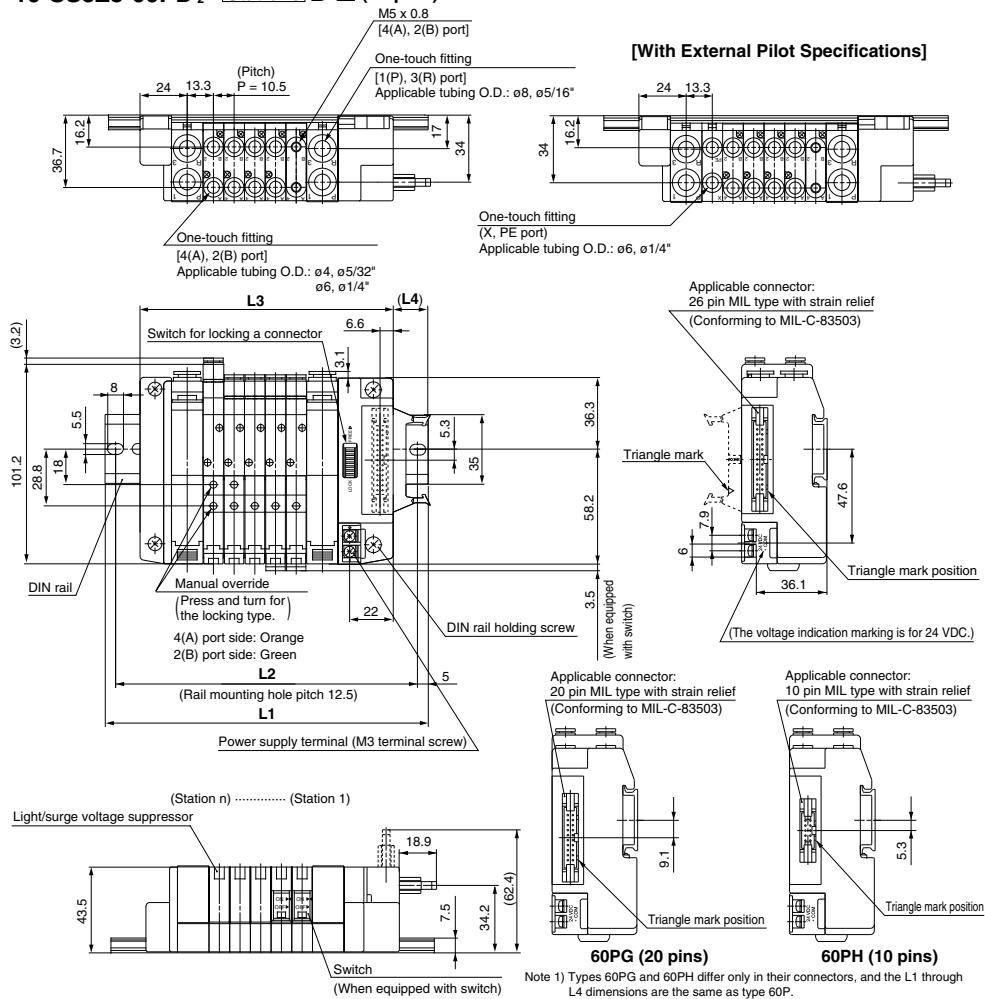

**Internal Pilot Manifold L Dimension**

n	2	3	4	5	6	7	8	9	10	11	12	13	14	15	16	17	18	19	20
L1	123	135.5	148	160.5	173	173	185.5	198	210.5	223	235.5	248	248	260.5	273	285.5	298	310.5	310.5
L2	112.5	125	137.5	150	162.5	162.5	175	187.5	200	212.5	225	237.5	237.5	250	262.5	275	287.5	300	300
L3	97	107.5	118	128.5	139	149.5	160	170.5	181	191.5	202	212.5	223	233.5	244	254.5	265	275.5	286
L4	13	14	15	16	17	12	13	14	15	16	17	18	12.5	13.5	14.5	15.5	16.5	17.5	12.5

**External Pilot Manifold L Dimension**

n	2	3	4	5	6	7	8	9	10	11	12	13	14	15	16	17	18	19	20
L1	135.5	148	160.5	173	173	185.5	198	210.5	223	235.5	248	248	260.5	273	285.5	298	310.5	310.5	323
L2	125	137.5	150	162.5	162.5	175	187.5	200	212.5	225	237.5	237.5	250	262.5	275	287.5	300	300	312.5
L3	107.5	118	128.5	139	149.5	160	170.5	181	191.5	202	212.5	223	233.5	244	254.5	265	275.5	286	296.5
L4	14	15	16	17	12	13	14	15	16	17	18	12.5	13.5	14.5	15.5	16.5	17.5	12.5	13.5

**Dimensions with Elbow Fitting: 10-SZ3000 for Plug-in, D-sub Connector**

10-SS5Z3-60FD<sub>2</sub> - [Stations] U<sub>B</sub> - □

(The fitting dimension of the flat ribbon cable and non plug-in types is the same.)

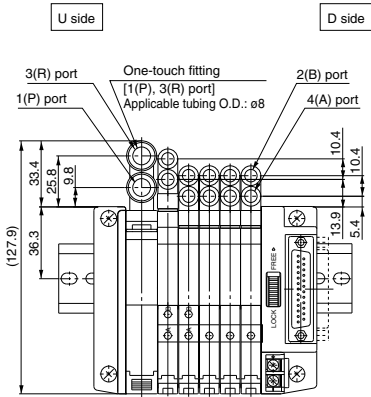
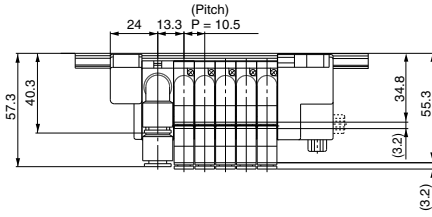

(Station n) ---- (Station 1)

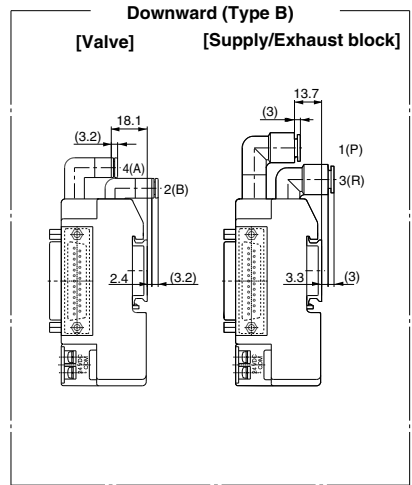
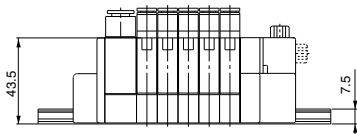

Directional Control Valves

Air Cylinders

Rotary Actuators

Air Grippers

Air Preparation Equipment

Modular F. R.

Pressure Control Equipment

Fittings & Tubing

Flow Control Equipment

Pressure Switches/ Pressure Sensors



# Series 10-SZ3000

5 Port Solenoid Valve  
Non Plug-in Type



## How to Order

An order cannot be placed with only the manifold part no. Be sure to order solenoid valves for mounting at the same time while referring to the ordering example.

### • Non plug-in manifold

**10-SS5Z3-60 - 05 U** [ ] [ ] - [ ] - [ ]

- Clean series**
- Stations**

02	2 stations
⋮	⋮
20	20 stations
- SUP/EXH block mounting position**

D	D side (2 to 10 stations)
U	U side (2 to 10 stations)
B	Both sides (2 to 20 stations)
M*	Special specifications

\* For special specifications, indicate separately with the manifold specification sheet.
- CE-compliant**

Nil	—
Q	CE-compliant
- Option**  
When a longer DIN rail is desired than the specified stations, specify the station number to be required.
- SUP/EXH block fitting type**

Nil	Straight
L	Elbow (Upward)
B	Elbow (Downward)
- Pilot type**

Nil	Internal pilot
R	External pilot

## How to Order Valve Manifold Assembly

### Ordering example (10-SZ3000, Non plug-in)

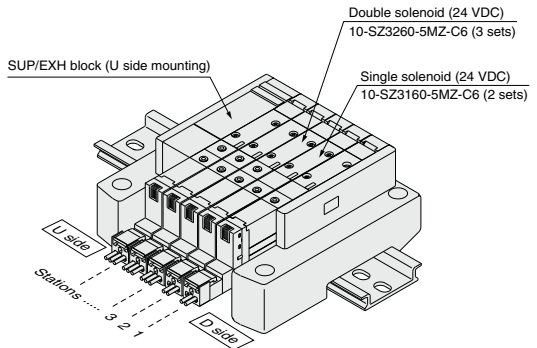

**10-SS5Z3-60-05U**.....1 set (Manifold part no.)  
 \* **10-SZ3160-5MZ-C6**.....2 sets (Single solenoid part no.)  
 \* **10-SZ3260-5MZ-C6**.....3 sets (Double solenoid part no.)  
 ↳ The asterisk denotes the symbol for assembly. Prefix to the part no. of the solenoid valve, etc.

Stations are counted from the D side as the 1st one.  
Add the valve part number under the manifold part number.  
For complex arrangements, specify them on the manifold specification sheet.

How to Order

10-SZ3 1 60 - 5 M - C6 -

● Clean series

Actuation type ●

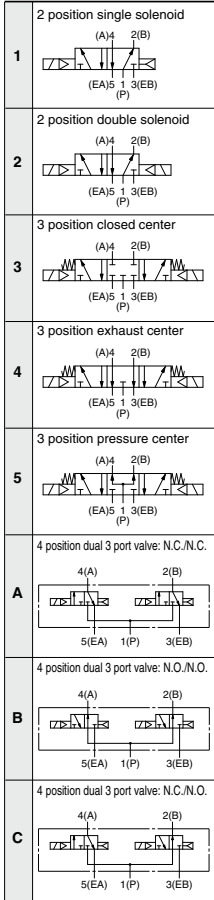

Pilot type ●

Nil	Internal pilot
R	External pilot

● External pilot specifications are not available for 4 position dual 3 port valves.

Back pressure check valve ●

Nil	None
K	Built-in

● The built-in back pressure check valve type has an effective area approximately 20% smaller.  
● The product with back pressure check valve is not available for 3 position solenoid valves.

Rated voltage ●

5	24 VDC
6	12 VDC

Common specifications ●

Nil	Positive common
N	Negative common

● The symbol is "Nil" for no light/surge voltage suppressor.

● CE-compliant

Nil	—
Q	CE-compliant

● A, B port size

C4: ø4 One-touch fitting  
C6: ø6 One-touch fitting  
N3: ø5/32" One-touch fitting  
N7: ø1/4" One-touch fitting



M5: M5 x 0.8



Elbow fitting assembly (Upward)

L4: ø4 elbow fitting assembly  
L6: ø6 elbow fitting assembly



Elbow fitting assembly (Downward)

B4: ø4 elbow fitting assembly  
B6: ø6 elbow fitting assembly

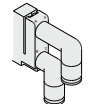

● Manual override

Nil: Non-locking push type

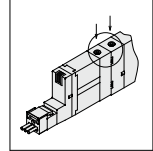

D: Push-turn locking slotted type

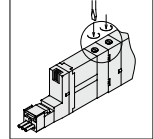

● Light/Surge voltage suppressor

Nil	Without light/surge voltage suppressor
S	With surge voltage suppressor
Z	With light/surge voltage suppressor

● Electrical entry

M: With lead wire (Length 300 mm)    MN: Without lead wire    MO: Without connector

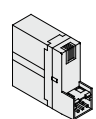
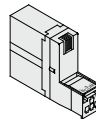
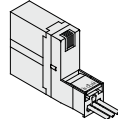

Directional Control Valves

Air Cylinders

Rotary Actuators

Air Grippers

Air Preparation Equipment

Modular F. R.

Pressure Control Equipment

Fittings & Tubing

Flow Control Equipment

Pressure Switches/ Pressure Sensors



**Made to Order**  
(For details, refer to page 411.)

## Manifold Specifications

<b>Model</b>		<b>Type 10-SSSZ3-60</b>	
<b>Manifold</b>		Non plug-in type	
<b>1 (P: SUP), 3/5 (R: EXH)</b>		Common SUP, EXH	
<b>Valve stations</b>		2 to 20 stations	
<b>4(A), 2(B) port Porting specifications</b>	<b>Location</b>	Valve	
	<b>Direction</b>	Lateral, Upward, Downward	
<b>Port size</b>	<b>Metric</b>	1(P), 3/5(R) port: ø8	4(A), 2(B) port: M5, ø4, ø6
	<b>Inch</b>	1(P), 3/5(R) port: ø5/16"	4(A), 2(B) port: ø5/32", ø1/4"
<b>Weight W (g)</b> <sup>Note 2)</sup> (n: Number of SUP/EXH blocks ) (m: Weight of DIN rail		W = 34n + m + 89	

Note 1) In cases such as those where many valves are operated simultaneously, use type B (double side SUP/EXH), applying pressure to the 1(P) ports on both sides and exhausting from the 3(R) ports on both sides.  
 Note 2) The weight W is the value for the manifold only. To obtain the weight with solenoid valves attached, add the solenoid valve weights given on page 382 for the appropriate number of stations. For DIN rail weight, refer to page 384.

## Flow Rate Characteristics

Port size		Flow rate characteristics					
1, 5, 3 (P, EA, EB)	4, 2 (A, B)	1 → 2/4 (P → A/B)			4/2 → 3 (A/B → R)		
		C [dm <sup>3</sup> /(s·bar)]	b	Cv	C [dm <sup>3</sup> /(s·bar)]	b	Cv
C8	C4	0.58 [0.49]	0.26 [0.36]	0.14 [0.13]	0.76 [0.65]	0.15 [0.20]	0.18 [0.15]
	C6	0.73 [0.64]	0.24 [0.27]	0.18 [0.16]	0.77 [0.74]	0.19 [0.16]	0.19 [0.19]
	M5	0.60 [0.57]	0.38 [0.35]	0.17 [0.15]	0.67 [0.58]	0.16 [0.39]	0.16 [0.16]

Note) · The values are for individually operated 2 position type manifold bases with 5 stations.  
 · Values inside [ ] are for 4 position dual 3 port valves.

Dimensions: 10-SZ3000 for Non Plug-in

10-SS5Z3-60- [Stations] U

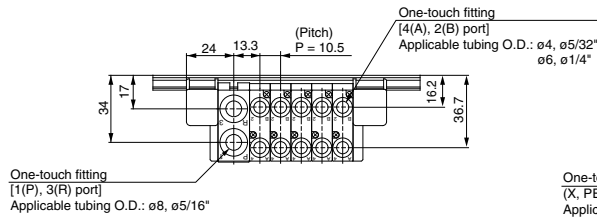

[With External Pilot Specifications]

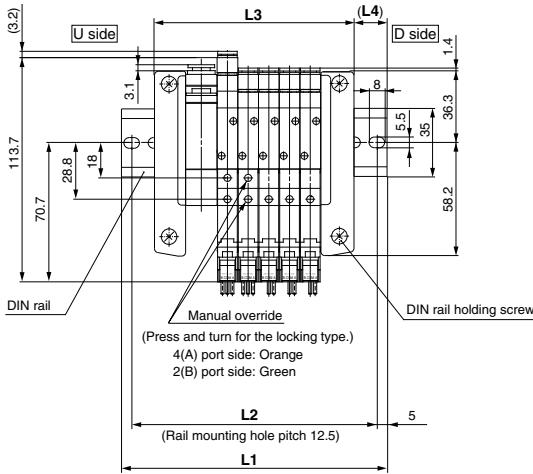
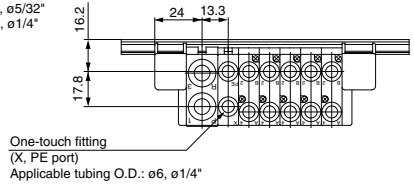

(Station n).....(Station 1)

Light/Surge voltage suppressor

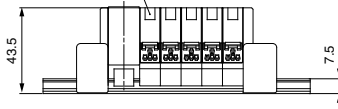

Note) For manifold dimensions with elbow fitting, refer to page 392.

Internal Pilot Manifold					L Dimension					n: Stations												
L	n	2	3	4	5	6	7	8	9	10	L	n	2	3	4	5	6	7	8	9	10	
L1	98	110.5	123	135.5	135.5	148	160.5	173	185.5													
L2	87.5	100	112.5	125	125	137.5	150	162.5	175													
L3	70	80.5	91	101.5	112	122.5	133	143.5	154													
L4	14	15	16	17	12	13	14	15	16													

External Pilot Manifold					L Dimension					n: Stations												
L	n	2	3	4	5	6	7	8	9	10	L	n	2	3	4	5	6	7	8	9	10	
L1	110.5	123	135.5	135.5	148	160.5	173	185.5	198													
L2	100	112.5	125	125	137.5	150	162.5	175	187.5													
L3	80.5	91	101.5	112	122.5	133	143.5	154	164.5													
L4	15	16	17	12	13	14	15	16	17													

**Dimensions: 10-SZ3000 for Non Plug-in**

**10-SS5Z3-60- [Stations] D**

**[With External Pilot Specifications]**

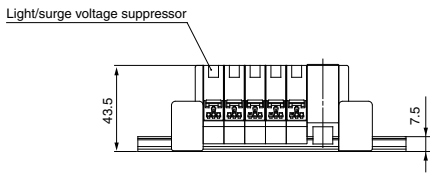
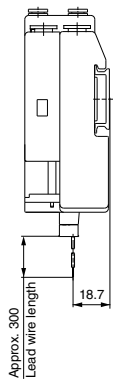
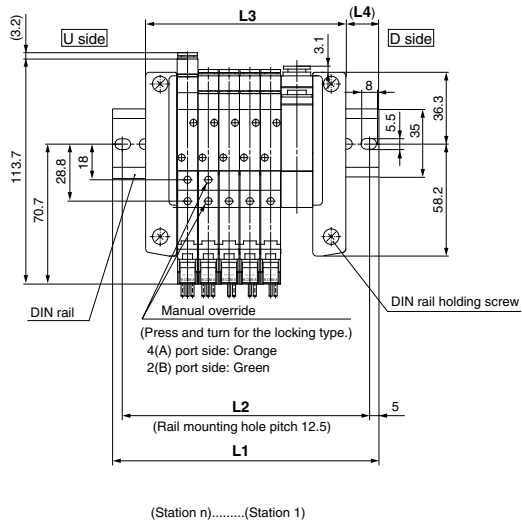
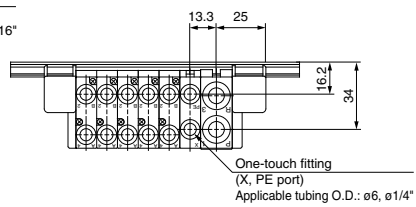
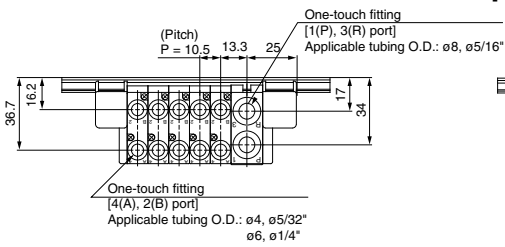

Note) For manifold dimensions with elbow fitting, refer to page 392.

Internal Pilot Manifold		L Dimension								n: Stations		
L	n	2	3	4	5	6	7	8	9	10		
L1	98	110.5	123	135.5	135.5	148	160.5	173	185.5			
L2	87.5	100	112.5	125	125	137.5	150	162.5	175			
L3	70	80.5	91	101.5	112	122.5	133	143.5	154			
L4	14	15	16	17	12	13	14	15	16			

External Pilot Manifold		L Dimension								n: Stations		
L	n	2	3	4	5	6	7	8	9	10		
L1	110.5	123	135.5	135.5	148	160.5	173	185.5	198			
L2	100	112.5	125	125	137.5	150	162.5	175	187.5			
L3	80.5	91	101.5	112	122.5	133	143.5	154	164.5			
L4	15	16	17	12	13	14	15	16	17			

**Dimensions: 10-SZ3000 for Non Plug-in**

**10-SS5Z3-60- [Stations] B**

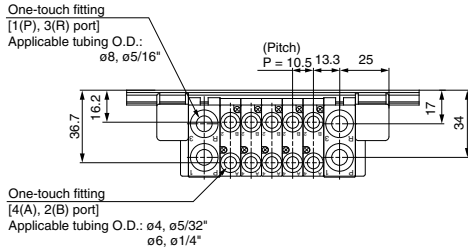

**[With External Pilot Specifications]**

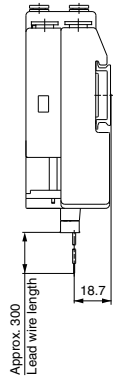
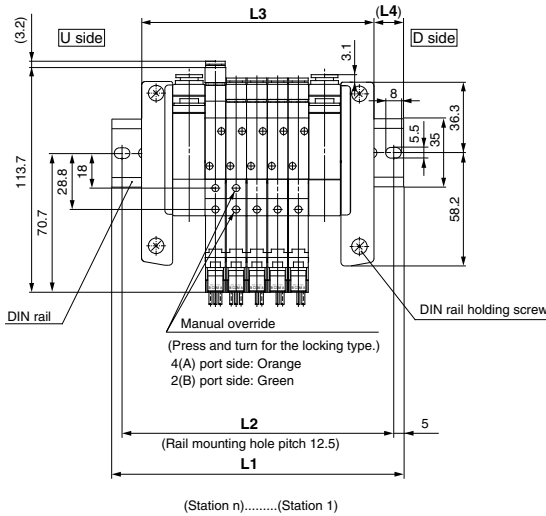
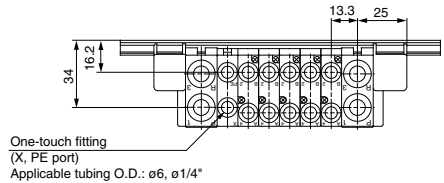

Note) For manifold dimensions with elbow fitting, refer to page 392.

**Internal Pilot Manifold L Dimension**

L	n	2	3	4	5	6	7	8	9	10	11	12	13	14	15	16	17	18	19	20
L1	n: Stations	110.5	123	135.5	148	160.5	173	173	185.5	198	210.5	223	235.5	235.5	248	260.5	273	285.5	298	310.5
L2	n: Stations	100	112.5	125	137.5	150	162.5	162.5	175	187.5	200	212.5	225	225	237.5	250	262.5	275	287.5	300
L3	n: Stations	86	96.5	107	117.5	128	138.5	149	159.5	170	180.5	191	201.5	212	222.5	233	243.5	254	264.5	275
L4	n: Stations	12	13	14	15	16	17	12	13	14	15	16	17	12	13	14	15	16	17	18

**External Pilot Manifold L Dimension**

L	n	2	3	4	5	6	7	8	9	10	11	12	13	14	15	16	17	18	19	20
L1	n: Stations	123	135.5	148	160.5	173	173	185.5	198	210.5	223	235.5	235.5	248	260.5	273	285.5	298	310.5	310.5
L2	n: Stations	112.5	125	137.5	150	162.5	162.5	175	187.5	200	212.5	225	225	237.5	250	262.5	275	287.5	300	300
L3	n: Stations	96.5	107	117.5	128	138.5	149	159.5	170	180.5	191	201.5	212	222.5	233	243.5	254	264.5	275	285.5
L4	n: Stations	13.5	14.5	15.5	16.5	17.5	12	13	14	15	16	17	12	13	14	15	16	17	18	12.5

Directional Control Valves  
Air Cylinders  
Rotary Actuators  
Air Grippers  
Air Preparation Equipment  
Modular F. R.  
Pressure Control Equipment  
Fittings & Tubing  
Flow Control Equipment  
Pressure Switches/ Pressure Sensors

# Type 60S□ Series 10-SZ3000

EX140 Integrated-type (For Output)  
Serial Transmission System



Note) Refer to the SI unit part no. for the SI unit comparable with CE.



An order cannot be placed with only the manifold part no. Be sure to order solenoid valves for mounting at the same time while referring to the ordering example.

## How to Order Manifold

**10 - SS5Z3 - 60S □ Q D - 05 U □ □ □ □ □ □ □ □**

**Clean series**

**SI unit specifications**

Symbol	Protocol type
<b>0</b>	Without SI unit
<b>H</b>	NKE Corp.: Fieldbus H System
<b>Q</b>	DeviceNet®
<b>R1</b>	OMRON Corp.: CompoBus/S System (16 outputs)
<b>R2</b>	OMRON Corp.: CompoBus/S System (8 outputs)
<b>V</b>	CC-Link

**SI unit mounting position**

<b>D</b>	D side
----------	--------

This should be indicated even without SI unit.

**Valve stations**

Symbol	Stations	Note
<b>02</b>	2 stations	Double wiring
<b>08</b>	8 stations	
<b>02</b>	2 stations	Specified layout (Up to 16 solenoids possible.)
<b>16</b>	16 stations	

Note 1) Double wiring: Single, double, 3 position and 4 position solenoid valves can be used at all of the manifold stations.  
 Note 2) Specified layout: Indicate wiring specifications on the manifold specification sheet. (Note that double, 3 and 4 position valves cannot be used where single solenoid wiring has been specified.)  
 Note 3) R2 and J2 are available with up to 8 solenoids.

**CE-compliant**

<b>Nil</b>	—
<b>Q</b>	CE-compliant

**Option**

When a longer DIN rail is desired than the specified stations, specify the station number to be required.

**SUP/EXH block fitting type**

<b>Nil</b>	Straight
<b>L</b>	Elbow (Upward)
<b>B</b>	Elbow (Downward)

**Pilot type**

<b>Nil</b>	Internal pilot
<b>R</b>	External pilot

**SUP/EXH block mounting position**

<b>U</b>	U side (2 to 10 stations)
<b>D</b>	D side (2 to 10 stations)
<b>B</b>	Both sides (2 to 16 stations)
<b>M</b>	Special specifications

**SI unit part no.**

Symbol	Protocol type	SI unit part no.	CE-compliant
<b>H</b>	NKE Corp.: Fieldbus H System	EX140-SUH1	—
<b>Q</b>	DeviceNet®	EX140-SDN1	○
<b>R1</b>	OMRON Corp.: CompoBus/S (16 outputs)	EX140-SCS1	○
<b>R2</b>	OMRON Corp.: CompoBus/S (8 outputs)	EX140-SCS2	○
<b>V</b>	CC-Link	EX140-SMJ1	○

\* For special specifications, indicate separately with the manifold specification sheet.  
 Note) A total of up to 3 SUP/EXH blocks can be mounted. Please contact SMC if 4 or more will be mounted.

## How to Order Valve Manifold Assembly

### Ordering example (CompoBus/S compatible SI unit)

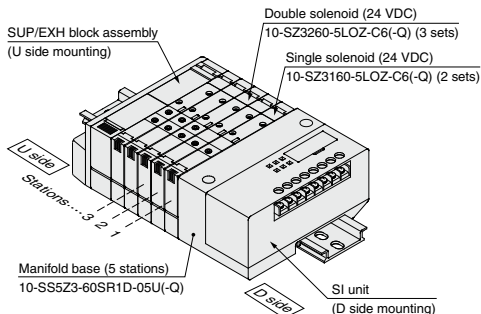

**10-SS5Z3-60SR1D-05U (-Q) ..... 1 set (Manifold part no.)**  
 \* **10-SZ3160-5LOZ-C6 (-Q) ..... 2 sets (Single solenoid part no.)**  
 \* **10-SZ3260-5LOZ-C6 (-Q) ..... 3 sets (Double solenoid part no.)**

↳ The asterisk denotes the symbol for assembly. Prefix it to the part no. of the solenoid valve, etc.

Stations are counted from the D side as the 1st one.  
 Add the valve part number under the manifold part number.  
 For complex arrangements, specify them on the manifold specification sheet.

## How to Order Solenoid Valve

10-SZ3 1 60 - 5 LOZ - C6

• Clean series

• Actuation type

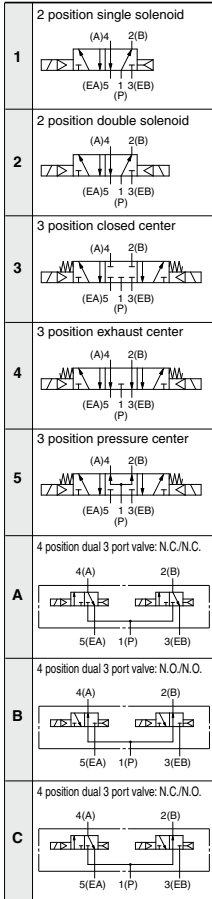

• Rated voltage

5	24 VDC
---	--------

• CE-compliant

Nil	—
Q	CE-compliant

• Made to Order

Nil	—
X90	Main valve fluororubber (Refer to page 411.)

• Switch

Nil: Without switch

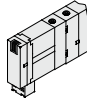

J: With switch

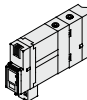

\* For switch operation, refer to page 412.

• Manual override

Nil: Non-locking push type

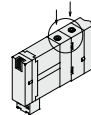

D: Push-turn locking slotted type

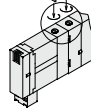

• A, B port size

C4: ø4 One-touch fitting  
C6: ø6 One-touch fitting



M5: M5 x 0.8



Elbow fitting assembly (Upward)  
L4: ø4 elbow fitting assembly  
L6: ø6 elbow fitting assembly



Elbow fitting assembly (Downward)  
B4: ø4 elbow fitting assembly  
B6: ø6 elbow fitting assembly

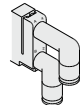

• Back pressure check valve

Nil	None
K	Built-in

- The built-in back pressure check valve type has an effective area approximately 20% smaller.
- The product with back pressure check valve is not available for 3 position solenoid valves.

• Pilot type

Nil	Internal pilot
R	External pilot

- External pilot specifications are not available for 4 position dual 3 port valves.

Directional Control Valves

Air Cylinders

Rotary Actuators

Air Grippers

Air Preparation Equipment

Modular F. R.

Pressure Control Equipment

Fittings & Tubing

Flow Control Equipment

Pressure Switches/ Pressure Sensors



**Dimensions: 10-SZ3000 for EX140 Integrated-type (For Output) Serial Transmission System**

10-SS5Z3-60S □ D- Stations U

[With External Pilot Specifications]

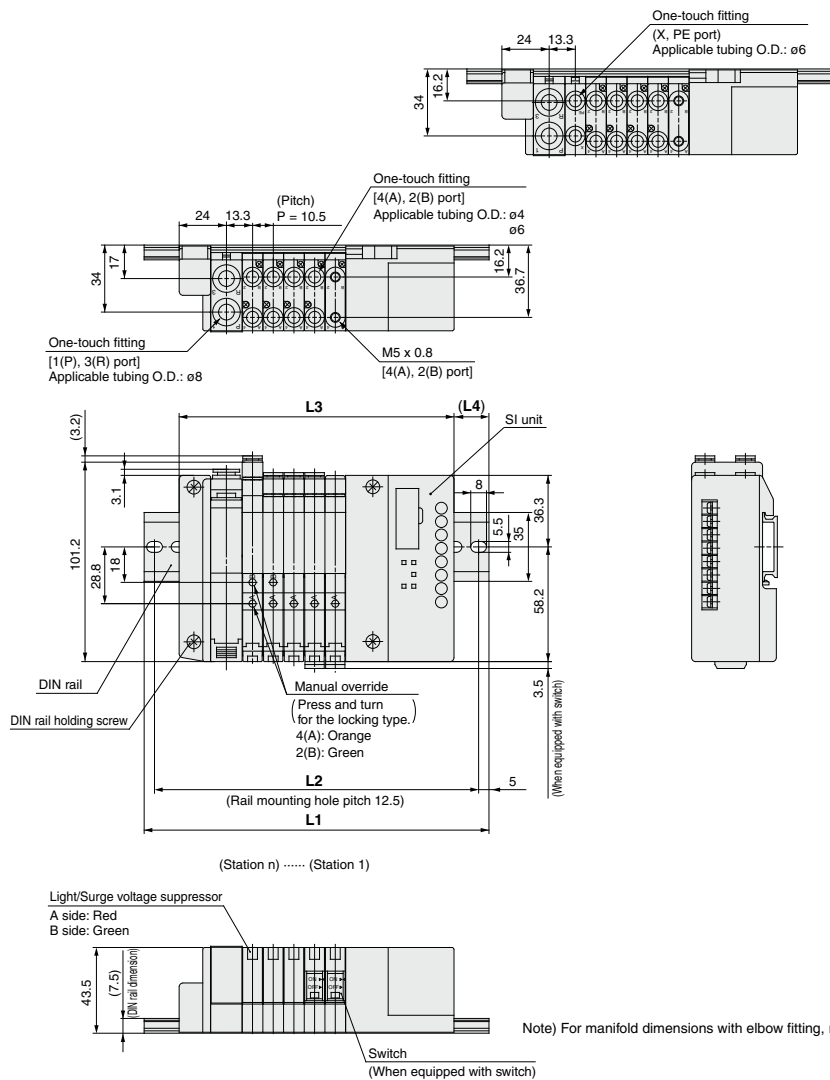

**Internal Pilot Manifold L Dimension**

n: Stations

L \ n	2	3	4	5	6	7	8	9	10
L1	135.5	148	160.5	173	185.5	185.5	198	210.5	223
L2	125	137.5	150	162.5	175	175	187.5	200	212.5
L3	108	118.5	129	139.5	150	160.5	171	181.5	192
L4	14	15	16	17	18	12.5	13.5	14.5	15.5

**External Pilot Manifold L Dimension**

n: Stations

L \ n	2	3	4	5	6	7	8	9	10
L1	148	160.5	173	185.5	185.5	198	210.5	223	235.5
L2	137.5	150	162.5	175	175	187.5	200	212.5	225
L3	118.5	129	139.5	150	160.5	171	181.5	192	202.5
L4	15	16	17	18	12.5	13.5	14.5	15.5	16.5

Dimensions: 10-SZ3000 for EX140 Integrated-type (For Output) Serial Transmission System

10-SS5Z3-60S □ D- Stations B

[With External Pilot Specifications]

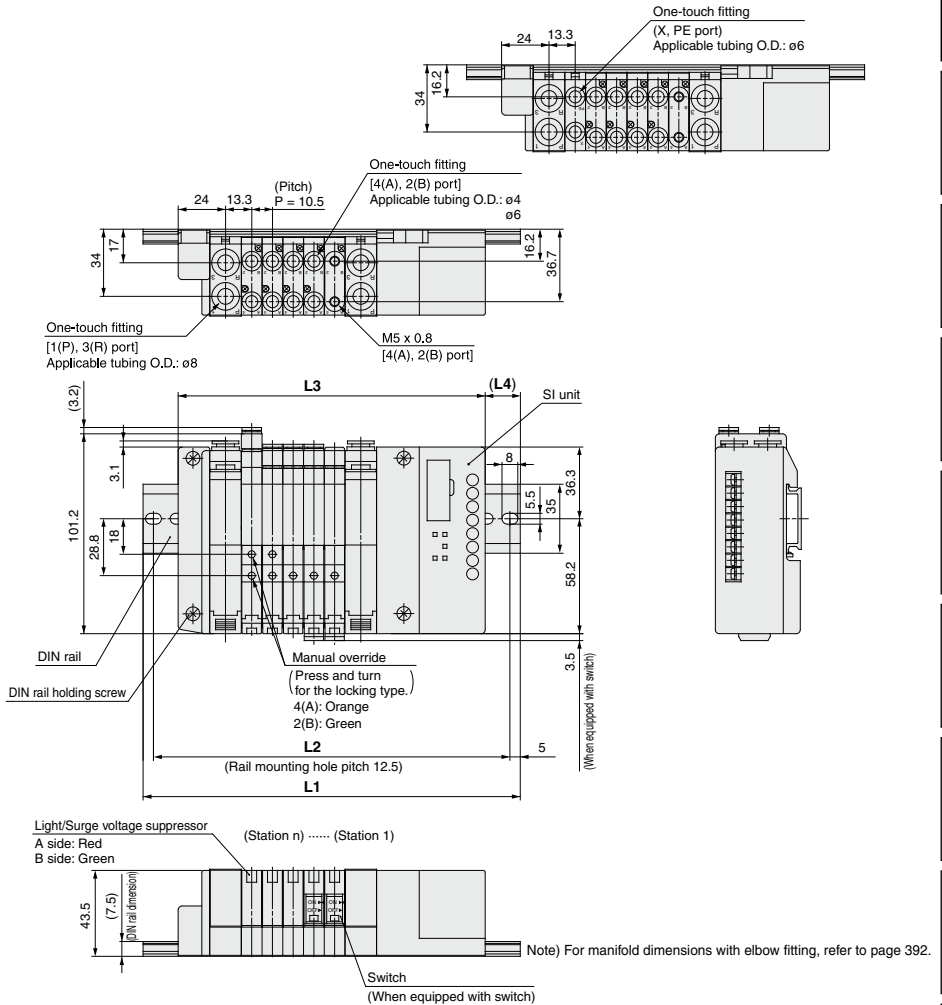

Internal Pilot Manifold L Dimension n: Stations

n	2	3	4	5	6	7	8	9
L1	148	160.5	173	185.5	198	210.5	210.5	223
L2	137.5	150	162.5	175	187.5	200	200	212.5
L3	124	134.5	145	155.5	166	176.5	187	197.5
L4	12	13	14	15	16	17	12	13

n	10	11	12	13	14	15	16
L1	235.5	248	260.5	273	285.5	285.5	298
L2	225	237.5	250	262.5	275	275	287.5
L3	208	218.5	229	239.5	250	260.5	271
L4	14	15	16	17	18	12.5	13.5

External Pilot Manifold L Dimension n: Stations

n	2	3	4	5	6	7	8	9
L1	160.5	173	185.5	198	210.5	210.5	223	235.5
L2	150	162.5	175	187.5	200	200	212.5	225
L3	134.5	145	155.5	166	176.5	187	197.5	208
L4	13	14	15	16	17	12	13	14

n	10	11	12	13	14	15	16
L1	248	260.5	273	285.5	285.5	298	310.5
L2	237.5	250	262.5	275	275	287.5	300
L3	218.5	229	239.5	250	260.5	271	281.5
L4	15	16	17	18	12.5	13.5	14.5

Directional Control Valves  
Air Cylinders  
Rotary Actuators  
Air Grippers  
Air Preparation Equipment  
Modular F. R.  
Pressure Control Equipment  
Fittings & Tubing  
Pressure Switches/ Pressure Sensors

# Type 60S6B Series 10-SZ3000

EX510 Gateway-type  
Serial Transmission System



An order cannot be placed with only the manifold part no. Be sure to order solenoid valves for mounting at the same time while referring to the ordering example.

## How to Order Manifold

10 - SS5Z3 - 60S6B [ ] D - 05 U [ ] [ ] [ ] [ ] [ ] [ ]

Clean series

### SI unit specifications

Nil	NPN output (+ COM)
N	PNP output (- COM)

### Unit mounting position

D	D side
---	--------

### CE-compliant

Nil	—
Q	CE-compliant

### Option

When a longer DIN rail is desired than the specified stations, specify the station number to be required. (Max. 16)

### SUP/EXH block fitting type

Nil	Straight
L	Elbow (Upward)
B	Elbow (Downward)

### Pilot type

Nil	Internal pilot
R	External pilot

### SUP/EXH block mounting position

U	U side	2 to 10 stations
D	D side	2 to 10 stations
B	Both sides	2 to 16 stations
M	Special specifications*	

\* For special specifications, indicate separately with the manifold specification sheet.

Note) A total of up to 3 SUP/EXH blocks can be mounted. Please contact SMC if 4 or more will be mounted.

### Valve stations

Symbol	Stations	Note
02	2 stations	Double wiring Note 1)
:	:	
08	8 stations	
02	2 stations	Specified layout Note 2) (Up to 16 solenoids possible.)
:	:	
16	16 stations	

\* Includes the number of blanking block assemblies.

Note 1) Double wiring: Single, double, 3 position and 4 position solenoid valves can be used at all of the manifold stations.

Note 2) Specified layout: Indicate wiring specifications on the manifold specification sheet. (Note that double, 3 and 4 position valves cannot be used where single solenoid wiring has been specified.)

## How to Order Valve Manifold Assembly

### Ordering example

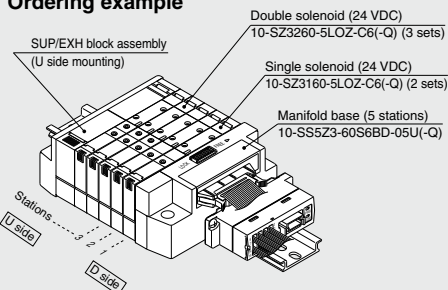

10-SS5Z3-60S6BD-05U (-Q) ...1 set (Type 60S6B 5-station manifold part no.)  
 \* 10-SZ3160-5LOZ-C6 (-Q) ...2 sets (Single solenoid part no.)  
 \* 10-SZ3260-5LOZ-C6 (-Q) ...3 sets (Double solenoid part no.)

The asterisk denotes the symbol for assembly. Prefix it to the part no. of the solenoid valve, etc.

- Stations are counted from the D side as the 1st one.
- Add the valve part number under the manifold part number.
- For complex arrangements, specify them on the manifold specification sheet.

### SI unit part no.

Symbol	SI unit specifications	SI unit part no.
Nil	NPN output (+ COM)	EX510-S002B
N	PNP output (- COM)	EX510-S102B

# How to Order

● How to order solenoid valve For plug-in (Common for both with and without power supply terminals)

10 - SZ3 1 60 - 5 LOZ - C6 -

● Clean series

● Actuation type ●

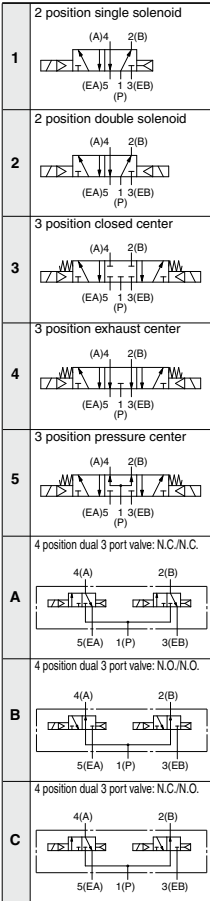

● Rated voltage

5	24 VDC
---	--------

● Back pressure check valve

Nil	None
K	Built-in

- The built-in back pressure check valve type has an effective area approximately 20% smaller.
- The product with back pressure check valve is not available for 3 position solenoid valves.

● Pilot type

Nil	Internal pilot
R	External pilot

- External pilot specifications are not available for 4 position dual 3 port valves.

● Switch

Nil: Without switch

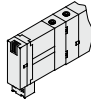

J: With switch

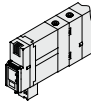

- \* For switch operation, refer to page 412.

● Common specifications

Nil	Positive common
N	Negative common

- When the SI unit specifications are PNP output (-COM), the common specifications of valves should be negative common.

● Manual override

Nil: Non-locking push type

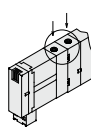

D: Push-turn locking slotted type

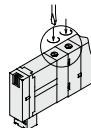

● CE-compliant

Nil	—
Q	CE-compliant

● Made to Order

Nil	—
X90	Main valve fluororubber (Refer to page 411.)

● A, B port size

- C4: ø4 One-touch fitting
- C6: ø6 One-touch fitting



M5: M5 x 0.5



- Elbow fitting assembly (Upward)
- L4: ø4 elbow fitting assembly
- L6: ø6 elbow fitting assembly



- Elbow fitting assembly (Downward)
- B4: ø4 elbow fitting assembly
- B6: ø6 elbow fitting assembly

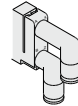

Directional Control Valves  
Air Cylinders  
Rotary Actuators  
Air Grippers  
Air Preparation Equipment  
Modular F. R.  
Pressure Control Equipment  
Fittings & Tubing  
Flow Control Equipment  
Pressure Switches/ Pressure Sensors



**Dimensions: 10-SZ3000 for EX510 Gateway-type Serial Transmission System**

10-SS5Z3-60S6B □ D- Stations B- □

[With External Pilot Specifications]

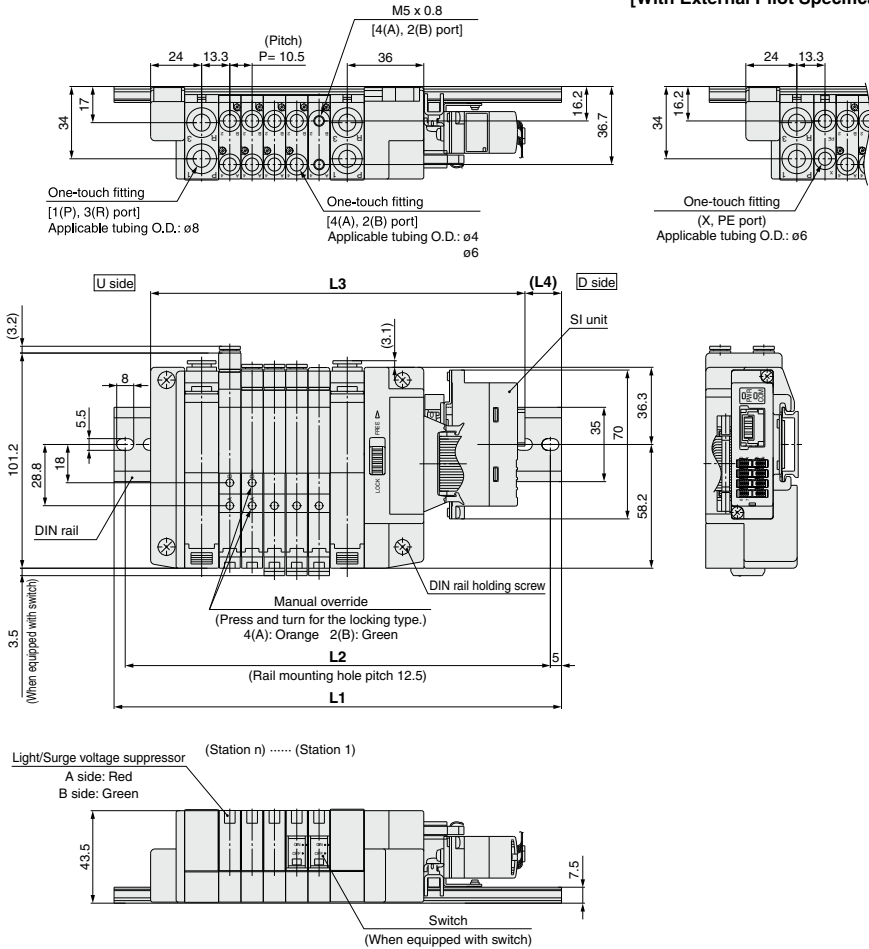

**Internal Pilot Manifold L Dimension**

L \ n	2	3	4	5	6	7	8	9	10	11	12	13	14	15	16
L1	173	185.5	198	210.5	223	223	235.5	248	260.5	273	285.5	298	298	310.5	323
L2	162.5	175	187.5	200	212.5	212.5	225	237.5	250	262.5	275	287.5	287.5	300	312.5
L3	144.6	155.1	165.6	176.1	186.6	197.1	207.6	218.1	228.6	239.1	249.6	260.1	270.6	281.1	291.6
L4	14	15	16	17	18	13	14	15	16	17	18	19	13.5	14.5	15.5

**External Pilot Manifold L Dimension**

L \ n	2	3	4	5	6	7	8	9	10	11	12	13	14	15	16
L1	185.5	198	210.5	223	223	235.5	248	260.5	273	285.5	298	298	310.5	323	335.5
L2	175	187.5	200	212.5	212.5	225	237.5	250	262.5	275	287.5	287.5	300	312.5	325
L3	155.1	165.6	176.1	186.6	197.1	207.6	218.1	228.6	239.1	249.6	260.1	270.6	281.1	291.6	302.1
L4	15	16	17	18	13	14	15	16	17	18	19	13.5	14.5	15.5	16.5

Directional Control Valves

Air Cylinders

Rotary Actuators

Air Grippers

Air Preparation Equipment

Modular F. R.

Pressure Control Equipment

Fittings & Tubing

Flow Control Equipment

Pressure Switches/ Pressure Sensors

# Series 10-SZ3000

## Made to Order

Please contact SMC for detailed specifications, delivery and pricing.

### 1 Main Valve Fluororubber Specifications -X90

Symbol

Fluororubber is used for rubber parts of the main valve to allow use in applications such as the following.

1. When using a lubricant other than the recommended turbine oil, and there is a possibility of malfunction due to swelling of the spool valve seals.
2. When ozone enters or is generated in the air supply.

Model no.

10-SZ3   60(R)             -X90

- Entry is the same as standard products.  
Specifications and performance are the same as standard products.

Note) Because in series -X90 fluororubber is used for only main valve, the rubber parts of the application/usage in conditions requiring heat resistance should be avoided.

### 2 Plug-in Manifold Connector and Serial Unit Mounted on U Side

Products are also available with the plug-in manifold connector mounting position and the serial unit mounting position on the reverse side (U side). For details about part numbers and wiring specifications, etc., please contact SMC.

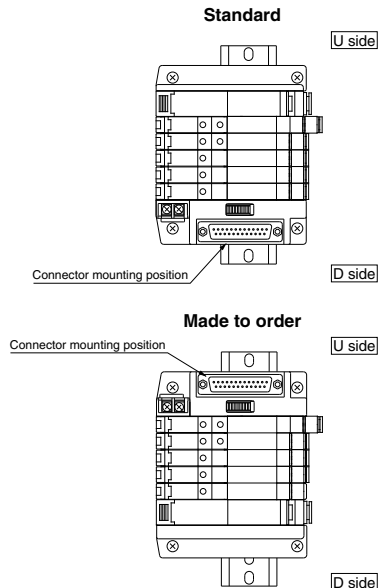

## ⚠ Specific Product Precautions 1

Be sure to read this before handling.

### ⚠ Warning

#### Manual Override Operation

Handle carefully, as connected equipment can be actuated through manual override operation.

##### ■ Non-locking push type

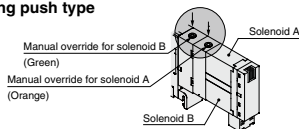

##### ■ Push-turn locking slotted type

While pressing the lock down, turn it in the direction of the arrow. If it does not turn, it can be operated the same way as the non-locking type.

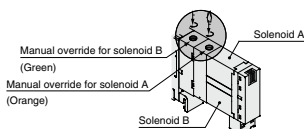

### ⚠ Caution

When locking the manual override on the push-turn locking slotted type, be sure to push the lock down before turning it. Turning without first pushing it down can cause damage to the manual override and other trouble such as air leakage, etc.

### ⚠ Warning

#### Valves with Switches

When turning OFF with the switch, be sure to move the switch to the locked position. Connected equipment may be actuated if current flow occurs with the switch at an improper position.

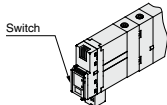

ON position



OFF position

Normal operating state. Switching of valve is based on an electric signal from the connector.

The valve coil is kept in a de-energized state even when there is an electric signal from the connector.

#### Electric circuit diagram (With positive common and light/surge voltage suppressor)

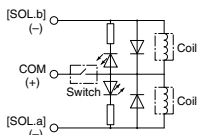

### ⚠ Caution

#### How to Use Plug Connector

When attaching and detaching a connector, first shut off the electric power and the air supply.

Also, crimp the lead wires and sockets securely.

##### 1. Attaching and detaching connectors

- To attach a connector, hold the lever and connector unit between your fingers and insert straight onto the pins of the solenoid valve so that the lever's pawl is pushed into the groove and locks.
- To detach a connector, remove the pawl from the groove by pushing the lever downward with your thumb, and pull the connector straight out.

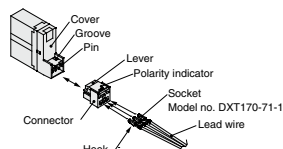

##### 2. Crimping connection of lead wire and socket

Strip 3.2 to 3.7 mm at the end of lead wires, insert the end of the core wires evenly into the sockets, and then crimp it with a crimping tool. When this is done, take care that the coverings of the lead wires do not enter the core wire crimping area. (Crimping tool: Model no. DXT170-75-1)

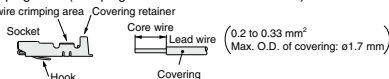

##### 3. Attaching and detaching lead wire with socket

- Attaching**  
Insert the sockets into the square holes of the connector (⊕ and ⊖ indication), and continue to push the sockets all the way in until they lock by hooking into the seats in the connector. (When they are pushed in, the hooks open and they are locked automatically.) Then confirm that they are locked by pulling lightly on the lead wires.
- Detaching**  
To detach a socket from a connector, pull out the lead wire while pressing the socket's hook with a thin tipped stick (approx. 1 mm). If the socket is to be used again, first spread the hook outward.

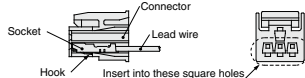

##### ■ Plug connector lead wire length

Standard length is 300 mm, but the following lengths are also available.

#### How to Order M Type Connector Assembly

##### Positive common specifications

- For single solenoid: **SX100-40-4S-**
- For double solenoid
- For 3 position type: **SX100-40-4D-**
- For 4 position type

##### Negative common specifications

- For single solenoid: **SX100-41-4S-**
- For double solenoid
- For 3 position type: **SX100-41-4D-**
- For 4 position type

##### Lead wire length

Nil	300 mm
6	600 mm
10	1000 mm
15	1500 mm
20	2000 mm
25	2500 mm
30	3000 mm
50	5000 mm

##### How to Order

Specify the part numbers of the solenoid valve without connector and the connector assembly with protective cover separately.

<Example> Lead wire length 2000 mm  
**10-SZ3160-5M0-M5**  
**SX100-40-4S-20**

Directional Control Valves

Air Cylinders

Rotary Actuators

Air Grippers

Air Preparation Equipment

Modular F. R.

Pressure Control Equipment

Fittings & Tubing

Flow Control Equipment

Pressure Switches/ Pressure Sensors



## ⚠ Specific Product Precautions 2

Be sure to read this before handling.

### ⚠ Caution

#### Common Connector Assembly for Manifold

By using a common connector assembly for the solenoid valves on a manifold, the common wiring for each solenoid valve is reduced to one line, making it possible to achieve labor savings on wiring work.

#### Common connector assembly part numbers

Positive common specifications  
For single solenoid  
**SX100-42-4S**



For double solenoid,  
3 position, 4 position types  
**SX100-42-4D**



With common lead wire for  
single solenoid  
**SX100-40-4S**



With common lead wire for  
double solenoid, 3 position,  
4 position types  
**SX100-40-4D**



(Lead wire length 300 mm)

Negative common specifications  
For single solenoid  
**SX100-43-4S**



For double solenoid,  
3 position, 4 position types  
**SX100-43-4D**



With common lead wire for  
single solenoid  
**SX100-41-4S**



With common lead wire for  
double solenoid, 3 position,  
4 position types  
**SX100-41-4D**



(Lead wire length 300 mm)

#### How to Order

Include the common connector assembly part number together with the manifold and solenoid valve part numbers. If the arrangement becomes complicated, then indicate on the manifold specification sheet.

Note 1) Take note that applications with unused connectors or with blanking plates between stations are not possible.

Note 2) For the solenoid valve, specify "without connector" for the plug connector type. The grommet type cannot be used.

Note 3) In places where signals will be sent to the common wiring, use a connector assembly with a common lead wire. (This is limited to the first station or the last station of a manifold.)

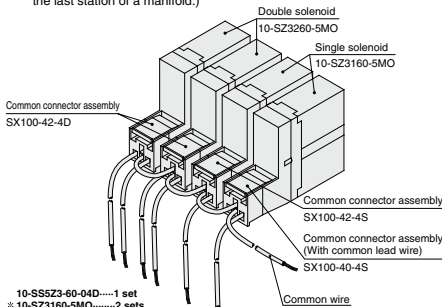

- 10-SS523-60-04D.....1 set
  - \* 10-SZ3160-5MO.....2 sets
  - \* 10-SZ3260-5MO.....2 sets
  - \* SX100-40-4S.....1 set (with common lead wire for single solenoid)
  - \* SX100-42-4S.....1 set (For single solenoid)
  - \* SX100-42-4D.....2 sets (For double solenoid, for 3 position, for 4 position)
- † The asterisk denotes the symbol for assembly. Prefix it to the part no. of solenoid valve, etc.

#### Common Connector Assembly Wiring

When ordering common connector assemblies only, wiring should be performed as outlined in the drawing below. For details on attachment of sockets, refer to the How to Use Plug Connector on page 412.

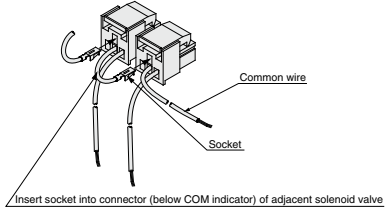

### ⚠ Caution

#### One-touch Fittings

The pitch determined for each of the 10-SZ series piping ports (P, A, B, etc.) is based on the assumption that the 10-KQ2 series One-touch fittings will be used. For this reason, other pipe fittings may interfere with each other depending on their type and size. Dimensions should be confirmed in a fitting catalog before they are used.

### ⚠ Caution

#### Exhaust Throttle

With the 10-SZ series, the pilot valve and main valve share a common exhaust inside the valve. Therefore, do not block the exhaust port when installing the piping.

### ⚠ Caution

#### 10-SZ3000 Series Used as a 3 Port Valve

##### When using a 5 port valve as a 3 port valve

The 10-SZ3000 series valves can be used as normally closed (N.C.) or normally open (N.O.) 3 port valves by closing one of the cylinder ports (A or B) with a plug. However, they should be used with the exhaust ports kept open. They are convenient at times when a double solenoid type 3 port valve is required.

		B port	A port
		N.C.	N.O.
Number of solenoids	Single		
	Double		

## ⚠ Specific Product Precautions 3

Be sure to read this before handling.

### ⚠ Caution

#### Light/Surge Voltage Suppressor

##### Positive common specifications

Single solenoid type

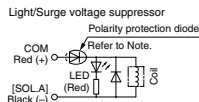

Surge voltage suppressor

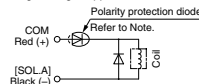

##### Positive common specifications

Double solenoid, 3 position, 4 position types

Light/surge voltage suppressor

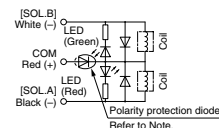

Surge voltage suppressor

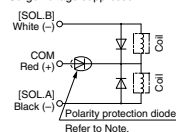

##### Negative common specifications

Single solenoid type

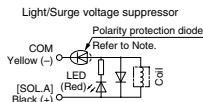

Surge voltage suppressor

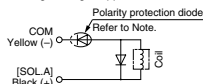

##### Negative common specifications

Double solenoid, 3 position, 4 position types

Light/surge voltage suppressor

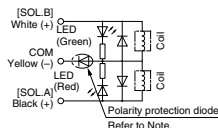

Surge voltage suppressor

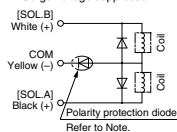

Note) Connect so that polarity is matched to the connector's (+), (-) and A, B and COM indicators. In case of voltage specifications other than 12 or 24 VDC, take care to avoid mistaking polarity, as there is no diode to prevent reverse current. In the event that lead wires are connected in advance, they will be as shown below.

##### Positive common specifications

- A (-): **Black**
- COM (+): **Red**
- B (-): **White** (No lead wire in case of single solenoid)

##### Negative common specifications

- A (+): **Black**
- COM (-): **Yellow**
- B (+): **White** (No lead wire in case of single solenoid)

### ⚠ Caution

#### Light Indication

When equipped with indicator light and surge voltage suppressor, the light window turns red when solenoid A is energized, and it turns green when solenoid B is energized.

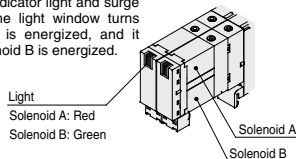

### ⚠ Caution

#### Changing the Connector Entry Direction

To change the connector entry direction, set the switch on the top of the connector block to the FREE position, and turn the connector. Make sure to set the switch back to the LOCK position before connecting the connector. (When the switch is difficult to slide, move the connector a little so that it will slide easier.)

If an excessive force is applied on the connector in the LOCK position, the connector block may be damaged. Also, using in such a way that the connector floats in the FREE position, it may cause the lead wire, etc. to break. Thus, refrain from using in these ways.

Switch for locking a connector

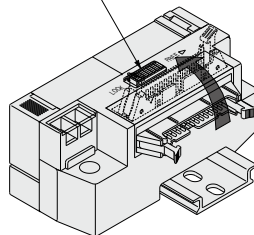

Directional Control Valves  
Air Cylinders  
Rotary Actuators  
Air Grippers  
Air Preparation Equipment  
Modular F. R.  
Pressure Control Equipment  
Fittings & Tubing  
Flow Control Equipment  
Pressure Switches/Pressure Sensors

**⚠ Specific Product Precautions 4****Be sure to read this before handling.****⚠ Caution****One-touch Fittings****1. Tubing attachment/detachment for One-touch fittings****1) Attaching of tubing**

(1) Take a tubing with no flaws on its periphery and cut it off at a right angle. When cutting the tubing, use tube cutters TK-1, 2 or 3. Do not use pinchers, nippers or scissors, etc. If cutting is done with tools other than tube cutter, the tubing may be cut diagonally or become flattened, making a secure installation impossible, and cause problems such as the tubing coming out after installation or air leakage.

Allow some extra length in the tubing.

(2) Grasp the tubing and push it in slowly, inserting it securely all the way into the fitting.

(3) After inserting the tubing, pull on it lightly to confirm that it will not come out. If it is not installed securely all the way into the fitting, this can cause problems such as air leakage or the tubing coming out.

**2) Detaching of tubing**

(1) Push in the release button sufficiently, pushing its collar equally around the circumference.

(2) Pull out the tubing while holding down the release button so that it does not come out. If the release button is not pressed down sufficiently, there will be increased bite on the tubing and it will become more difficult to pull it out.

(3) When the removed tubing is to be used again, cut off the portion which had been secured before reusing it. If the same portion of the tubing is reused, this can cause trouble such as air leakage or difficulty in removing the tubing.

**⚠ Caution****Other Tubing Brands**

1. When using tubing other than SMC brand tubing, confirm that the following specifications are satisfied with respect to the outside diameter tolerance of the tubing.

- 1) Nylon tubing within  $\pm 0.1$  mm
- 2) Soft nylon tubing within  $\pm 0.1$  mm
- 3) Polyurethane tubing within  $+0.15$  mm, within  $-0.2$  mm

Do not use tubing which do not meet these outside diameter tolerances. It may not be possible to connect them, or they may cause other trouble, such as air leakage or the tubing coming out after connection.

**⚠ Caution****Built-in Back Pressure Check Valve**

1. Valves with built-in back pressure check valve are to protect the back pressure inside a valve. For this reason, use caution that the valves with external pilot specifications cannot be pressurized from exhaust port [3(R)]. As compared with the types which do not integrate the back pressure check valve, C value of the flow rate characteristics goes down. For details, please contact SMC.
2. Do not switch valves when A or B port is open to the atmosphere, or while the actuators and air operated equipment are in operation. The back pressure prevention seal may be peeled off, which may cause air leakage or malfunctions. Use caution especially when performing a trial operation or maintenance work.