

Card Motor

LAT3 Series



The transportation, pushing and length measurement systems have been miniaturized through the use of a linear motor.

Weight
130 g
Stroke: 10 mm

Maximum stroke
50 mm

Thickness
9 mm

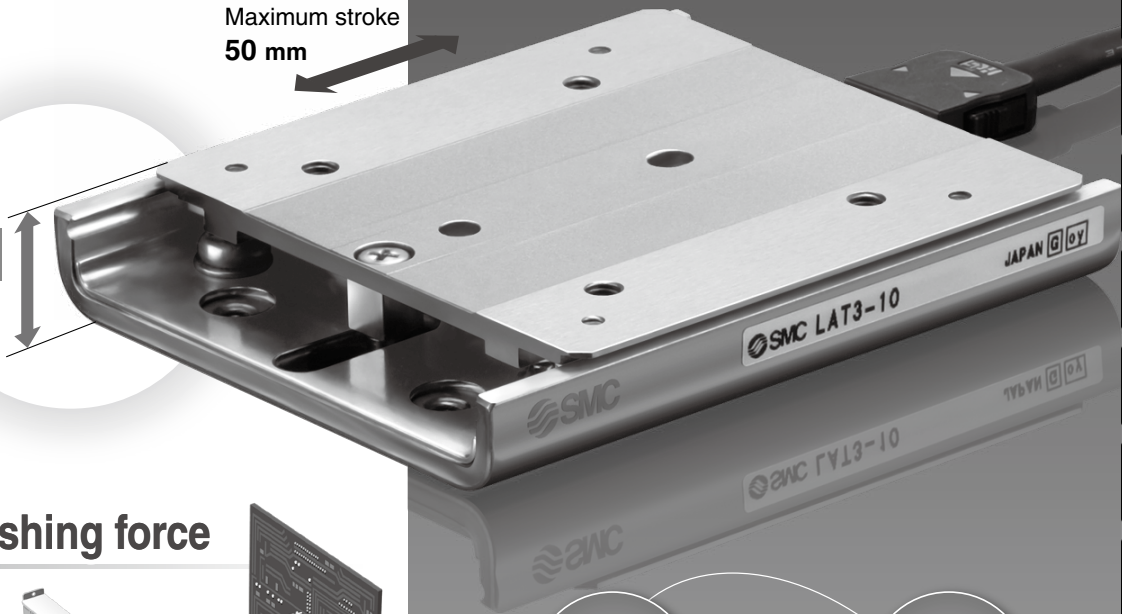

Maximum pushing force

6 N

Pushing a miniature load

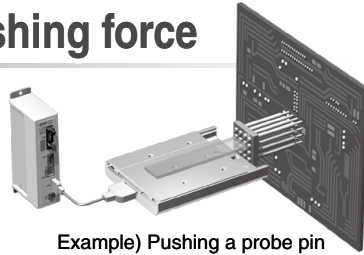

Example) Pushing a probe pin

Positioning repeatability

±5 μm

Positioning a workpiece

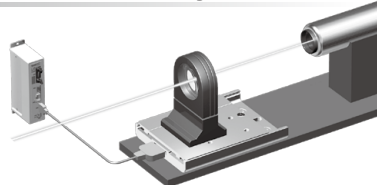

Example) Lens focusing

Pushing measurement accuracy

±10 μm

Parts measurement

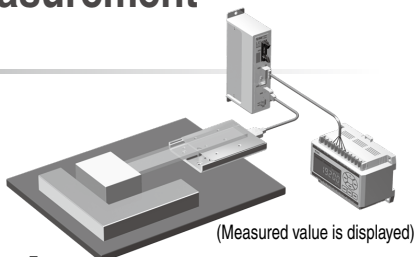

(Measured value is displayed)

Load mass: 100 g, Stroke: 5 mm

Maximum operating frequency

500 cpm

Rejection of non-conforming products etc.

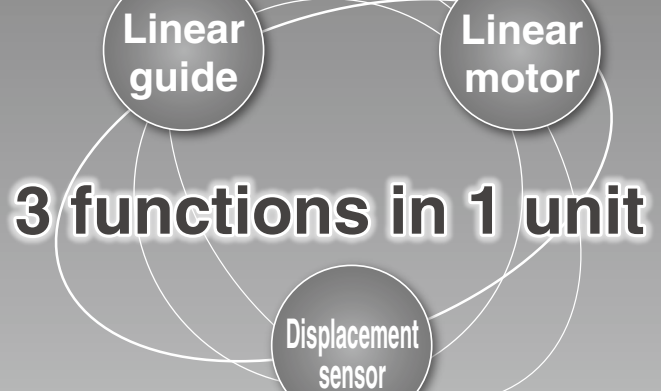
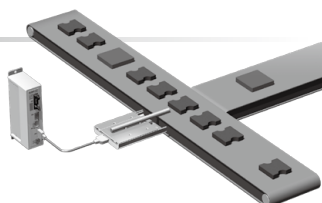

- Easy programming (Cycle time entry)

Just input
3 parameters:
Positioning time,
Target position,
Load mass.

- Serial communication
Modbus compatible



LEFS
LEFB
LEJS
LEJB
LEL
LEM
LEY
LEYG
LES
LESH
LEPY
LEPS
LER
LEH
LEH-X5
LEY-X5
11-LEFS
11-LEJS
11-LEJS
25A-
LEC
JXC
LECS
LECS-T
LECY
Motorless
LAT3

Compact and lightweight

Model	W [mm]	L [mm]	H [mm]	Weight [g]
LAT3□-10	50	60	9	130
LAT3□-20		90		190
LAT3□-30		120		250
LAT3□-50		150		360

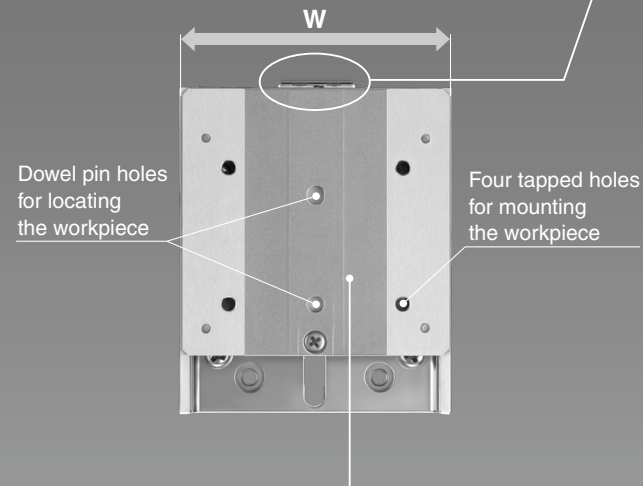

Workpiece Mounting

The table is provided with dowel pin holes for locating the workpiece as standard equipment.

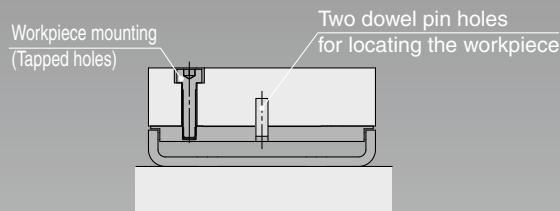

Cable Mounting

The cable connector does not protrude above the actuator.

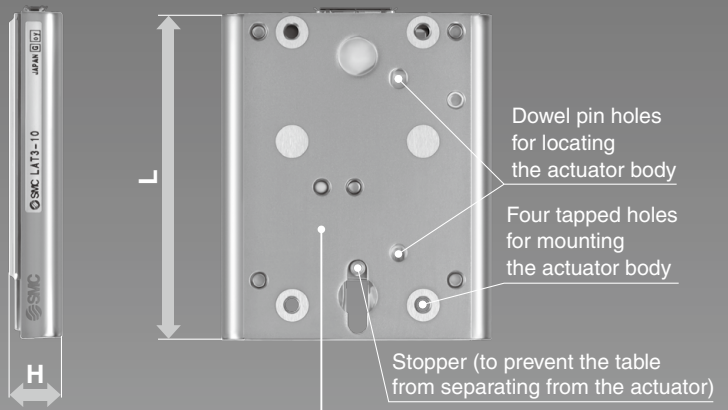
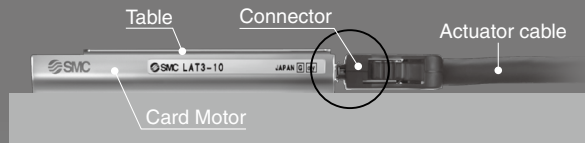

Body Mounting

2 body mounting options

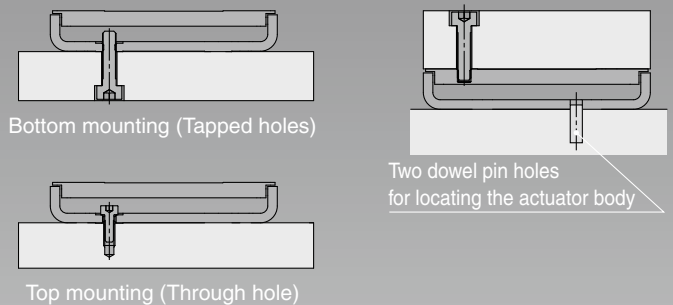

Series Variations

Model	Stroke				Sensor (Optical linear encoder) Resolution	Linear motor Type	Linear guide Type	Pushing* Maximum instantaneous thrust	Positioning repeatability Accuracy	Pushing measurement Accuracy	Maximum load mass		Maximum speed
	10	20	30	50							Horizontal	Vertical	
LAT3F	○	○	○	○	1.25 μm	Moving magnet type linear motor	Linear guide with circulating balls	Up to 6 N	±5 μm	±10 μm	1000 g	Up to 100 g	400 mm/s
LAT3M	—	—	—	○	5 μm				±20 μm	±40 μm			
LAT3	○	○	○	—	30 μm				±90 μm	±100 μm			

* The pushing and maximum load mass changes with the stroke. For details, refer to the specifications on page 954.

Structure and Working Principle

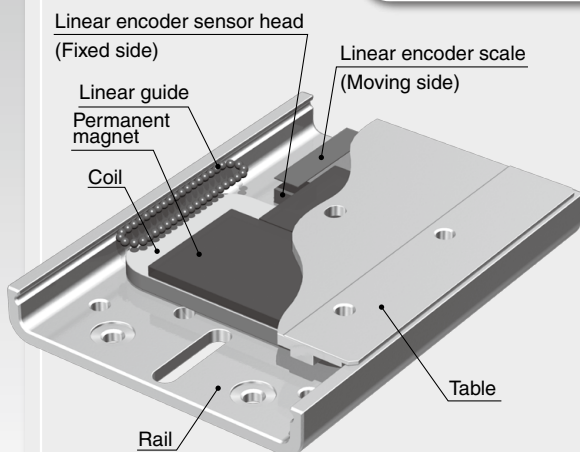

The permanent magnet is mounted on the bottom side of the table, and the coil is mounted on the top surface of the rail. When current is supplied to the coil, a north pole (N) is generated in the middle of the top surface of the coil. This north pole attracts the south pole (S) of the permanent magnet on the left and repels the north pole on the right, and these attracting and repelling forces generate the thrust force. Therefore, thrust force is applied to the table in the right direction, and the table moves to the right.

When current is applied to the coil in the reverse direction, a south pole will be generated in the middle of the top surface of the coil. Similarly, a thrust force will be applied to the table in the left direction, and the table moves to the left.

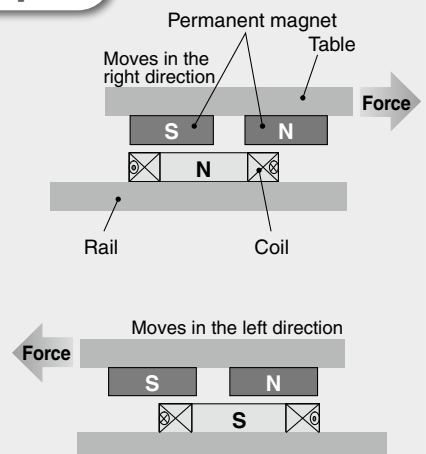

Start-up time is reduced greatly with a system that is ready-to-use and easy to set up.

The functions described below makes the start-up quick and easy.

Parallel Input/Output Status Check Function

The status of the parallel input signals can be checked, or the parallel output signals can be activated manually using a PC.

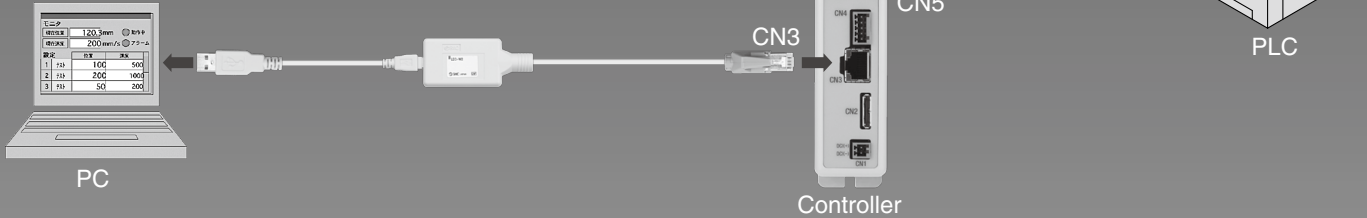

Built-in Operation Patterns

Positioning Operation (Absolute • Relative)

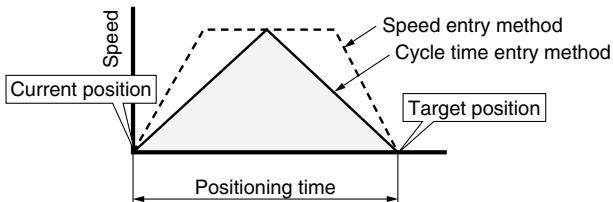

Absolute: The table moves to the target position with reference to the origin position and stops there.

Relative: The table moves to the target position with reference to the current position and stops there.

Pushing Operation (Absolute • Relative)

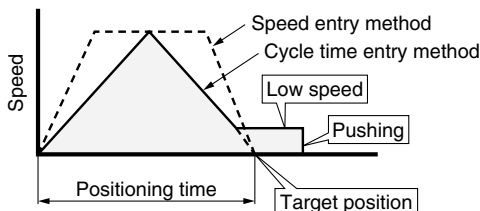

The table moves to a position close to the target position, decelerates to low speed and starts pushing after the table has come in contact with the workpiece.

Cycle Time Entry Method

Only target position and positioning time need to be entered, so there is no need to enter the speed, acceleration and deceleration.

(Using the speed entry method allows you to enter the speed, acceleration and deceleration.)

Step Data Input

The Card Motor operation type and condition are preset in the step data. The Card Motor is operated according to the contents of the selected preset step data number.

Step Data

No.	Operation	Movement MOD	Target Position [mm]	Positioning Time [s]	Speed [mm/s]	Accel [mm/s ²]	Decel [mm/s ²]	Thrust Setting Value	Load Mass [g]
1	Position	Absolute	0.000	0.30	0	0	0	1.0	0
2	Position	ABS	30.000	0.30	0	0	0	1.0	0
3	Position	ABS	15.000	0.20	0	0	0	1.0	0
4	Position	REL	-1.000	0.03	0	0	0	1.0	0
5	Position	REL	-1.000	0.03	0	0	0	1.0	0
6	Push	ABS	5.000	0.70	0	0	0	2.0	0
7	Push	ABS	5.000	1.00	0	0	0	1.0	0
8	Position	REL	5.000	1.00	0	0	0	1.0	0
9	Position	ABS	5.000	1.00	0	0	0	1.0	0
10	Position	REL	5.000	1.00	0	0	0	1.0	0
11	Position	ABS	5.000	1.00	0	0	0	1.0	0
12	Position	REL	5.000	1.00	0	0	0	1.0	0
13	Position	ABS	5.000	1.00	0	0	0	1.0	0
14	Position	REL	5.000	1.00	0	0	0	1.0	0
15	Position	ABS	5.000	1.00	0	0	0	1.0	0

Function for measuring and differentiation of workpieces

The size of the workpiece can be measured based on the table stopping position by driving the table until it comes into contact with the workpiece.

The workpieces can be differentiated or checked for quality using parallel output signals that correspond to preset table position ranges.

Furthermore, using the multi-counter (separately sold products: refer to page 974) makes it possible to display the table position and output up to 31 preset points.



- LEFS LEFB
- LEJS LEJB
- LEL
- LEM
- LEY LEYG
- LES LESH
- LEPY LEPS
- LER
- LEH
- LEY-X5
- 11-LEFS
- 11-LEJS
- 25A-
- LEC
- JXC
- LECS LECS-T
- LECY
- Motorless
- LAT3

Application Examples of Card Motor

The applications described below are just a few examples.

When using the Card Motor, select an appropriate model by carefully checking the specifications.

Examples of Positioning Applications

Sensor head movement and positioning

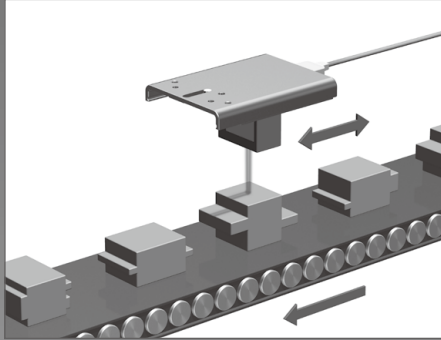

Component movement and positioning

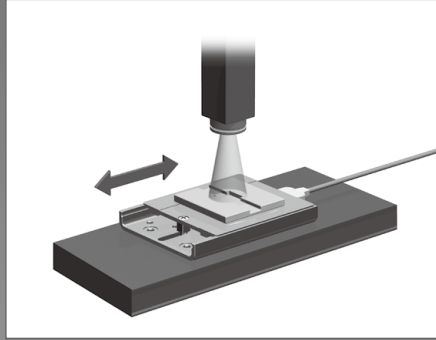

Electronic component pick and place

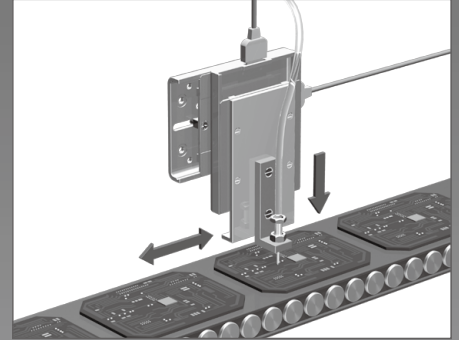

Component supply to tape

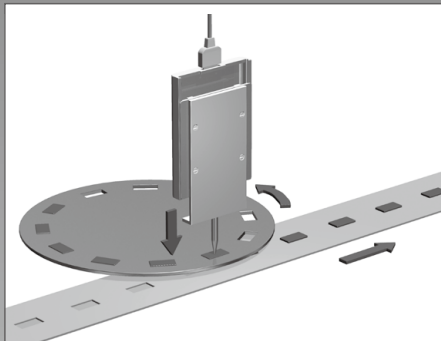

Component separation (escapement)

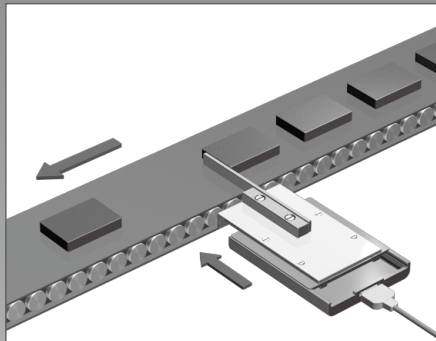

Workpiece alignment

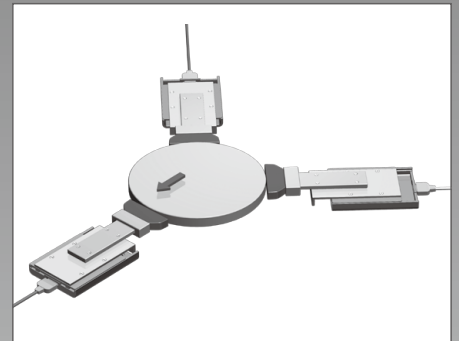

Examples of Measurement Applications

Measurement of workpiece height

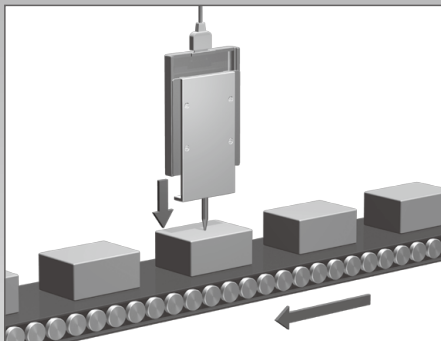

Measurement of glass substrate thickness (multiple points)

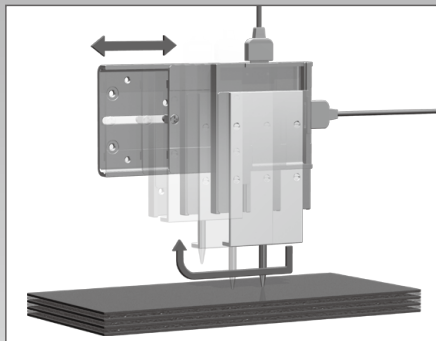

Measurement of cable outside diameter

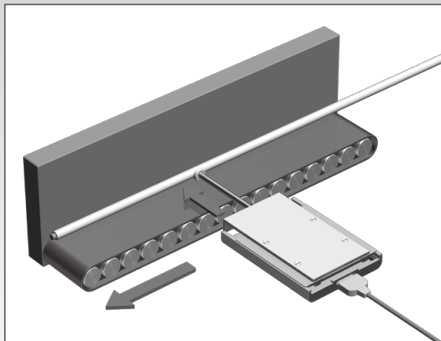

Measurement of tape thickness

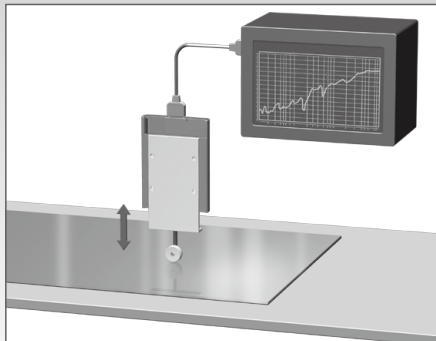

Examples of High Frequency Actuation

Alignment of components on pallet by vibration

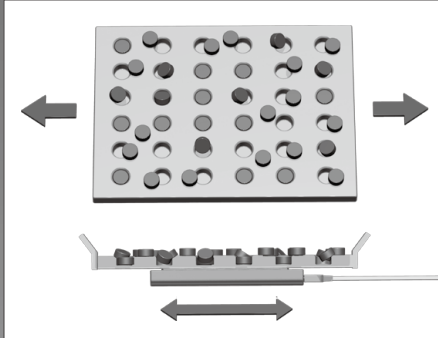

Distribution of workpieces

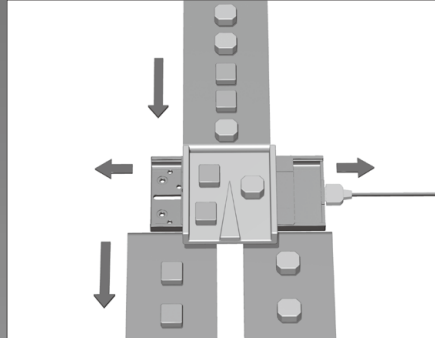

Examples of Pushing Applications

Pushing of workpieces (soft touch)



Positioning of workpieces

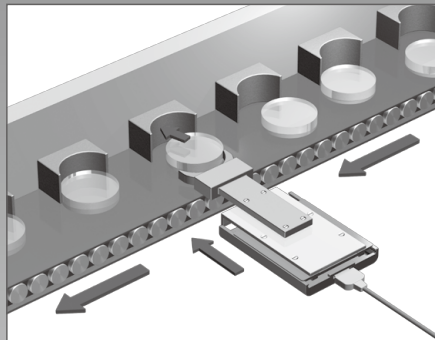

Cutting of resin mold component runners

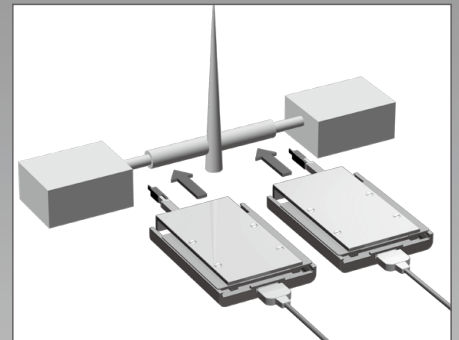

Tape alignment

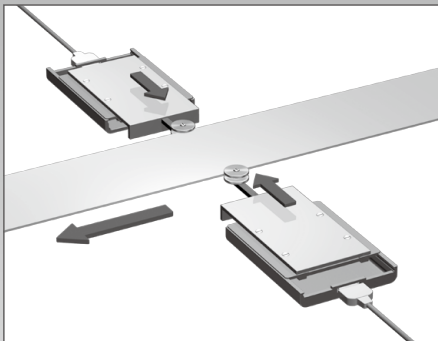

Switch inspection



High-density layout

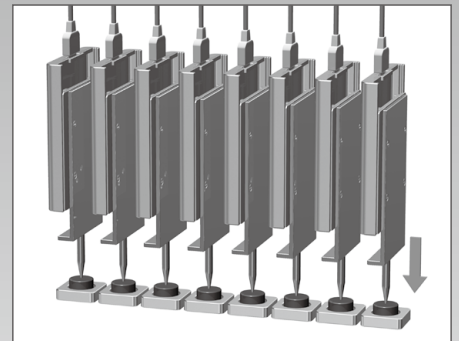

LEFS
LEFB

LEJS
LEJB

LEL

LEM

LEY
LEYG

LES
LESH

LEPY
LEPS

LER

LEH

LEY-X5

11-LEFS

11-LEJS

25A-

LEC

JXC

LECS
LECS-T

LECY

Motorless

LAT3

LAT3 Series Model Selection 1

Selection Procedure for Positioning Operation (Refer to pages 947 to 949 for **Fig.1, 2, 3, 4, 5** and **Table 1, 2, 3.**)

Selection Procedure

Formula / Data

Selection Example

1 Operating conditions

List the operating conditions with consideration to the mounting orientation and shape of the workpiece.

- Stroke St [mm]
- Load mass W [g]
- Mounting orientation
- Mounting angle θ [°] **Fig.2**
- Amount of overhang Ln [mm] **Fig.1**
- Correction values for the distances to the moment center An [mm] **Fig.1 Table 1**

- 15 mm
- 300 g
- Horizontal table mounting
- $\theta = 0^\circ$
- $L_1 = -10$ mm
- $L_2 = 30$ mm
- $L_3 = 35$ mm
- $T_p = 200$ ms
- 100 μ m

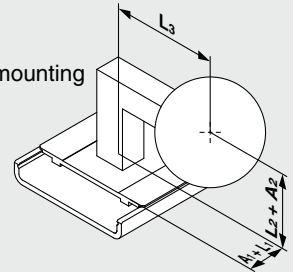

2 Select an actuator temporarily.

Select a model temporarily based on the required positioning repeatability and stroke.

Table 2

Model	LAT3-10	LAT3F-10	LAT3-20	LAT3F-20	LAT3-30	LAT3F-30	LAT3M-50	LAT3F-50
Stroke [mm]	10		20		30		50	
Positioning repeatability [μ m]	± 90	± 5	± 90	± 5	± 90	± 5	± 20	± 5
Measuring accuracy [μ m]	30	1.25	30	1.25	30	1.25	5	1.25
Table weight [g]	50		70		90		110	

From Table 2, temporarily select the **LAT3-20**, which satisfies the positioning repeatability 100 μ m and the minimum stroke that satisfies the stroke $St = 15$

3 Check the load mass and load factor.

Find the allowable load mass W_{max} [g] from the graph.

- * Confirm that the applied load mass W [g] does not exceed the allowable load mass.

W_{max} **Fig.2**

$$W \leq W_{max}$$

A_n **Table 1**

$$M = W/1000 \cdot 9.8 (L_n + A_n)/1000$$

M_{max} **Table 3**

$$\alpha = M/M_{max}$$

$$\sum \alpha_p + \alpha_y + \alpha_r \leq 1$$

From Table 1, find the correction values for the distances to the moment center. Calculate the static moment M [N·m]. From Table 3, find the allowable moment M_{max} [N·m]. Calculate the load factor α_n for the static moments.

- * Confirm that the total sum of the guide load factors for the static moments does not exceed 1.

From Fig. 2: $\theta = 0$, find $W_{max} = 1000$
As $W = 300 < W_{max} = 1000$, the selected model can be used.

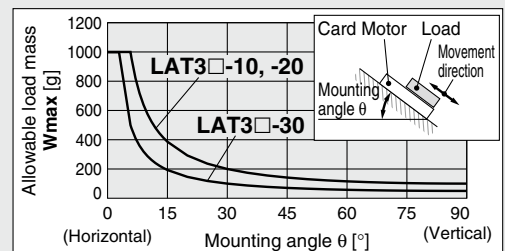

From Table 1, $A_1 = 32.5$

Pitch moment

$$M_p = 300/1000 \times 9.8 (-10 + 32.5)/1000 = 0.066$$

From Table 3, $M_{pmax} = 0.3$
 $\alpha_p = 0.066/0.3 = 0.22$

Roll moment

$$M_r = 300/1000 \times 9.8 \times 35/1000 = 0.103$$

From Table 3, $M_{rmax} = 0.2$
 $\alpha_r = 0.103/0.2 = 0.52$
 $\sum \alpha_n = 0.22 + 0.52 = 0.74 \leq 1$, thus, the selected model can be used.

4 Check the positioning time.

Find the shortest positioning time T_{min} [ms] from the graph.

- * Confirm that the positioning time T_p [ms] is longer than the shortest positioning time.

T_{min} **Fig.3**

$$T_p \geq T_{min}$$

From Fig. 3: $St = 15$ and $W = 300$, find $T_{min} = 150$
As $T_p = 200 \geq T_{min} = 150$, the selected model can be used.

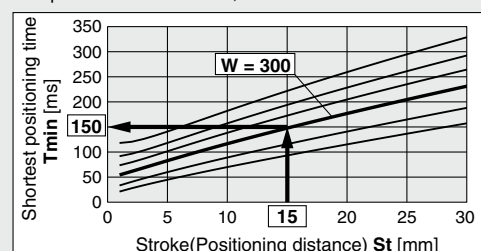

Selection Procedure for Pushing Operation

Selection Procedure Formula / Data Selection Example

1 Operating conditions

List the operating conditions with consideration to the mounting orientation and shape of the workpiece.

* When operating the product in a vertical direction, consider the effect of the table weight on the Card Motor (See Table 2) and the weight of the workpiece to find out the pushing force of the Card Motor.

- Stroke St [mm]
- Load mass W [g]
- Mounting orientation
- Mounting angle θ [°]
- Amount of overhang (L_1, L_2, L_3) [mm] **Fig.1**
- Correction values for the distances to the moment center An [mm]

- Measuring accuracy [μm] **Fig.1 Table 1**
- Positioning time Tp [ms]
- Pushing force F [N]
- Pushing position [mm]
- Pushing direction
- Positioning time + Pushing time Ta [s]
- Cycle time Tb [s]

- 8 mm
- 50 g
- Horizontal table mounting
- $\theta = 0^\circ$
- $L_1 = 30$ mm
- $L_2 = 10$ mm
- $L_3 = 0$ mm
- 10 μm
- $Tp = 150$ ms
- 4 N
- 4 mm
- Pushing direction away from the connector
- 4 s
- 10 s

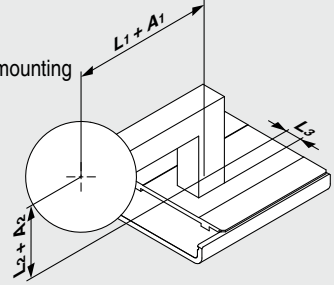

2 Select an actuator temporarily.

Select a model temporarily based on the required measuring accuracy and stroke.

Table 2

Model	LAT3-10	LAT3F-10	LAT3-20	LAT3F-20	LAT3-30	LAT3F-30	LAT3M-50	LAT3F-50
Stroke [mm]	10		20		30		50	
Positioning repeatability [μm]	± 90	± 5	± 90	± 5	± 90	± 5	± 20	± 5
Measuring accuracy [μm]	30	1.25	30	1.25	30	1.25	5	1.25
Table weight [g]	50		70		90		110	

From Table 2, temporarily select the **LAT3F-10**, which satisfies the measuring accuracy 10 μm and the minimum stroke that satisfies the stroke $St = 8$

3 Check the load mass and moment.

Find the allowable load mass W_{max} [g] from the graph.

* Confirm that the applied load mass W [g] does not exceed the allowable load mass.

From Table 1, find the correction values for the distances to the moment center. Calculate the static moment M [N·m].

From Table 3, find the allowable moment M_{max} [N·m]. Calculate the load factor α_n for the static moments.

* Confirm that the total sum of the guide load factors for the static moments does not exceed 1.

W_{max} **Fig.2**

$W \leq W_{\text{max}}$

An **Table 1**

$M = W/1000 \cdot 9.8 (Ln + An)/1000$

M_{max} **Table 3**

$\alpha = M/M_{\text{max}}$

$\sum \alpha_p + \alpha_y + \alpha_r \leq 1$

From Fig. 2: $\theta = 0$, find $W_{\text{max}} = 500$

As $W = 50 < W_{\text{max}} = 500$, the selected model can be used.

From Table 1, $A_1 = 22.5$

Pitch moment

$M_p = 50/1000 \times 9.8 (30 + 22.5)/1000 = 0.026$

From Table 3, $M_{p\text{max}} = 0.2$

$\alpha_p = 0.026/0.2 = 0.13$

$\sum \alpha_n = 0.13 \leq 1$, thus, the selected model can be used.

4 Check the positioning time.

Find the shortest positioning time T_{min} [ms] from the graph.

* Confirm that the positioning time Tp [ms] is longer than the minimum positioning time.

T_{min} **Fig.3**

$Tp \geq T_{\text{min}}$

From Fig. 3: $St = 8$ and $W = 50$, find $T_{\text{min}} = 100$

As $Tp = 150 \geq T_{\text{min}} = 100$, the selected model can be used.

5 Check the pushing force.

Calculate the duty ratio [%].

Find the allowable thrust setting value from the graph.

From Fig. 5, find the allowable pushing force F_{max} [N] generated at the required pushing position and for the allowable thrust setting value. Confirm that the pushing force F [N] does not exceed the allowable pushing force.

Duty ratio = $Ta/Tb \times 100$ **Fig.4**

$F \leq F_{\text{max}}$

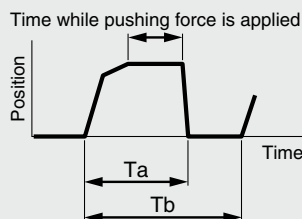

Duty ratio = $4/10 \times 100 = 40\%$

From Fig. 4: **LAT3□-10** and 40% duty ratio, find the allowable thrust setting value = 4.2

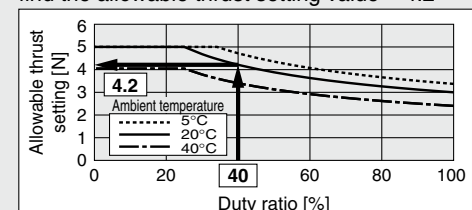

From Fig. 5: **LAT3□-10**, pushing direction away from the connector at pushing position 4 mm, find $F_{\text{max}} = 4.5$

As $F = 4 \leq F_{\text{max}} = 4.5$, the selected model can be used.

- LEFS
- LEFB
- LEJS
- LEJB
- LEL
- LEM
- LEYG
- LESH
- LEPS
- LER
- LEH
- LEY-X5
- 11-LEFS
- 11-LEJS
- 25A-
- LEC□
- JXC□
- LECS□
- LECS□-T
- LECY□
- Motorless
- LAT3

LAT3 Series Model Selection 2

Selection

⚠ Caution

1. The temperature increase of the Card Motor varies depending on the duty ratio and the heat dissipation properties of the base it is mounted onto. If the temperature of the Card Motor becomes high, reduce the duty ratio by increasing the cycle time, or improve the heat transfer properties of the mounting base and the surroundings.
2. The pushing force generated by the Card Motor varies in relation to the thrust setting value depending on the pushing position and the pushing direction. Refer to Fig. 5 for details.

Fig. 1 Amount of Overhang: L_n [mm], Correction Value for Distances to Moment Center: A_n [mm]

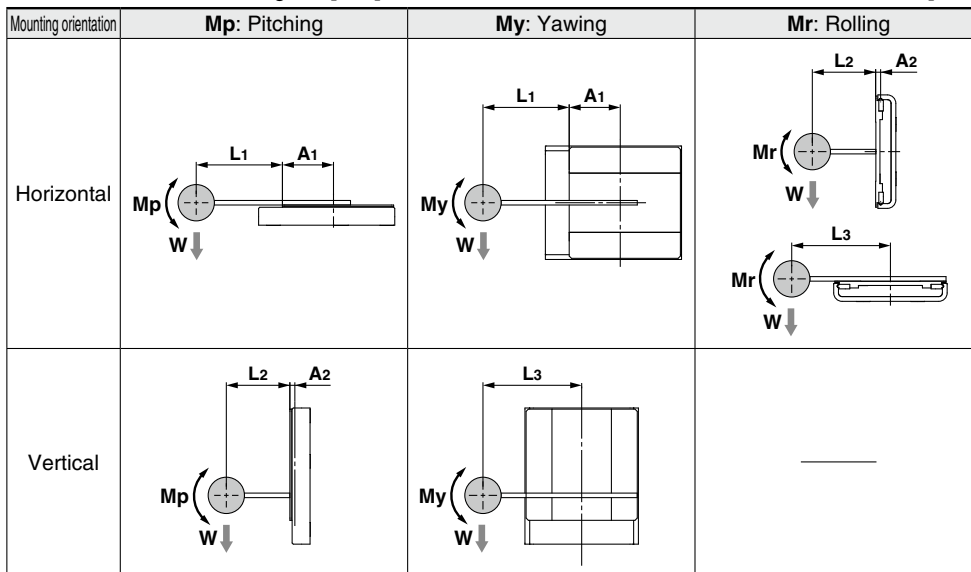
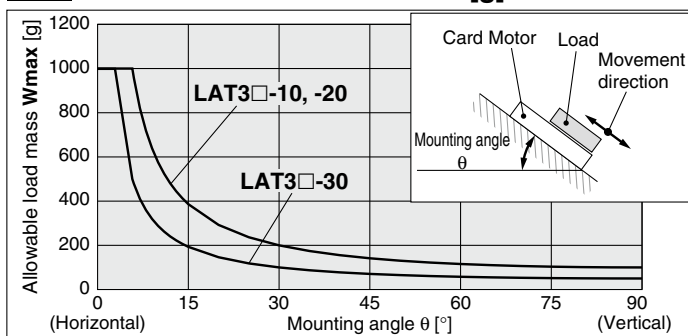

Table 1 Correction Value for Distances to Moment Center: A_n [mm]

Model	A_1	A_2
LAT3□-10	22.5	2.2
LAT3□-20	32.5	2.2
LAT3□-30	42.5	2.2
LAT3□-50	35	2.4

Fig. 2 Allowable Load Mass: W_{max} [g]



* LAT3□-50 can be used only at the horizontal mounting angle (0°).

Fig. 3 Shortest Positioning Time (Reference): T_{min} [ms]

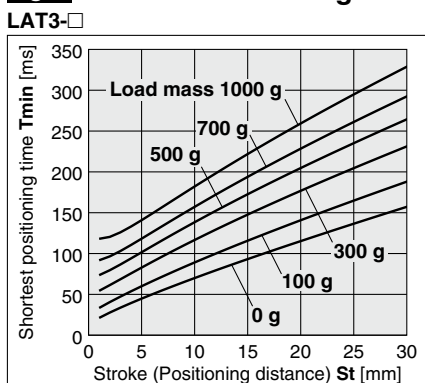

Operating conditions
Model: LAT3□
Mounting orientation: Horizontal/Vertical

Step data input version: Cycle time entry method (Triangular movement profile)

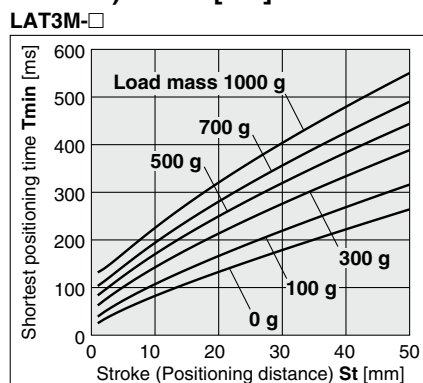

Operating conditions
Model: LAT3M□
Mounting orientation: Horizontal/Vertical

Step data input version: Cycle time entry method (Triangular movement profile)

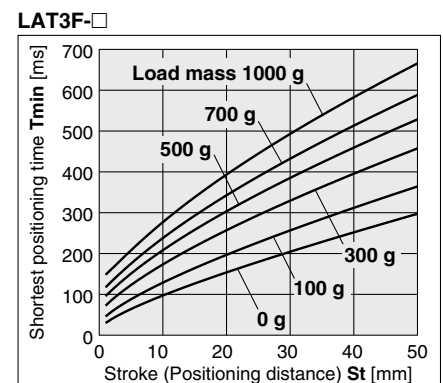

Operating conditions
Model: LAT3F□
Mounting orientation: Horizontal/Vertical

Step data input version: Cycle time entry method (Triangular movement profile)

Fig. 4 Allowable Thrust Setting Value

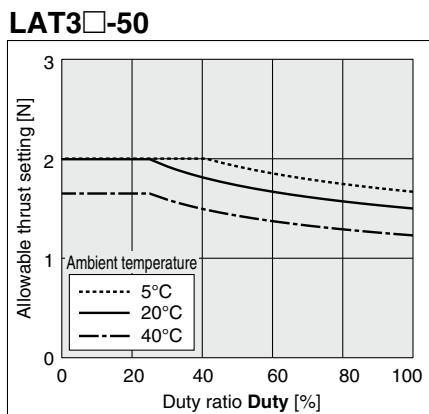
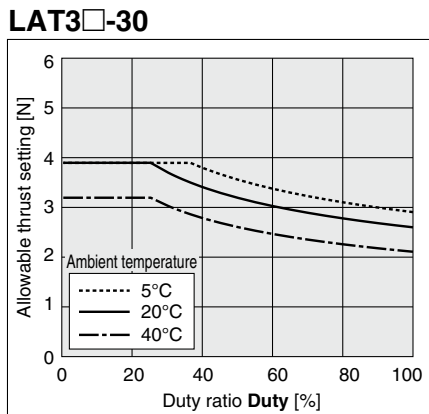
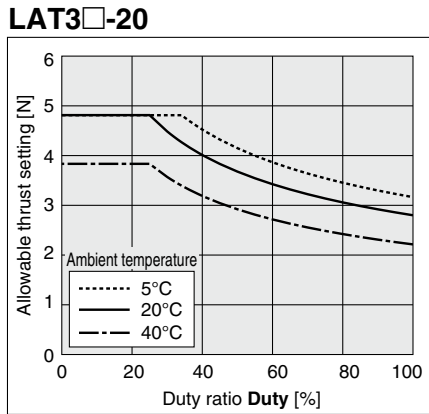
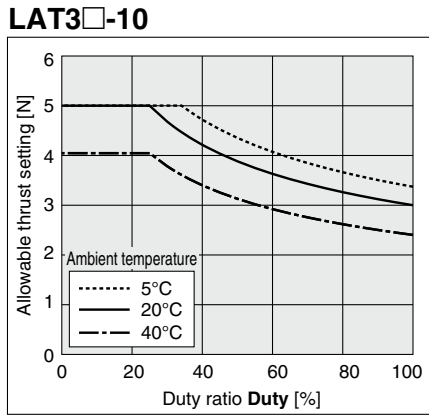
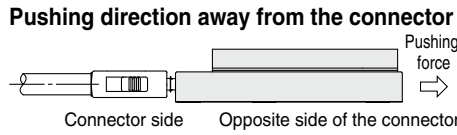
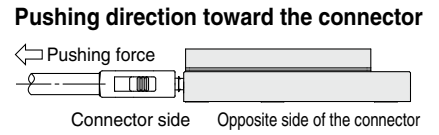
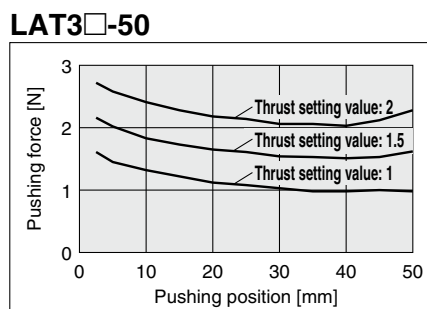
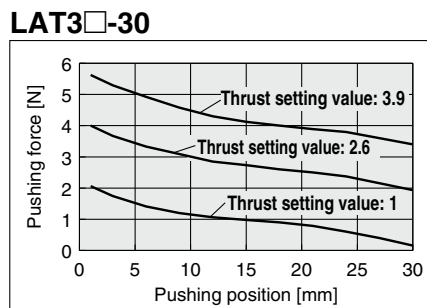
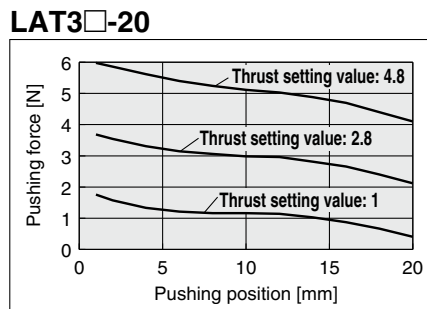
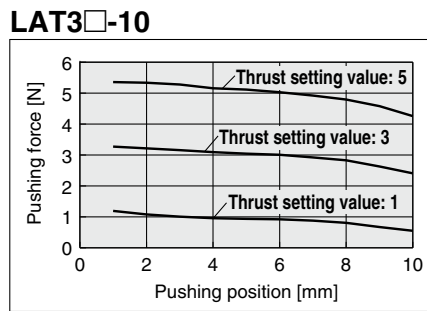

Fig. 5 Pushing Force: F [N] Characteristics (Reference)



Operating conditions
 Mounting orientation: Horizontal table mounting
 Pushing force settings: Minimum, continuous, or maximum instantaneous thrust of each model

Table start position: Retracted end (Connector side)
 Pushing direction: Away from the connector
 Pushing position: Positioning distance from the connector side, retracted end



Operating conditions
 Mounting orientation: Horizontal table mounting
 Pushing force settings: Minimum, continuous, or maximum instantaneous thrust of each model

Table start position: Extended end (Opposite side of the connector)
 Pushing force direction: Toward the connector
 Pushing position: Positioning distance from the connector side, retracted end

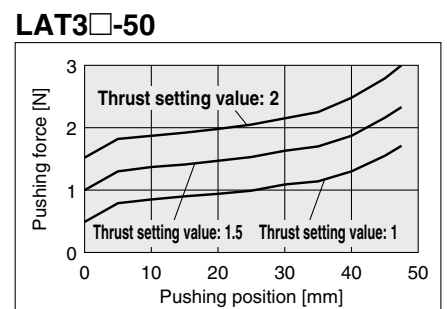
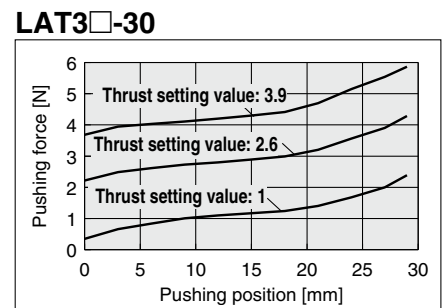
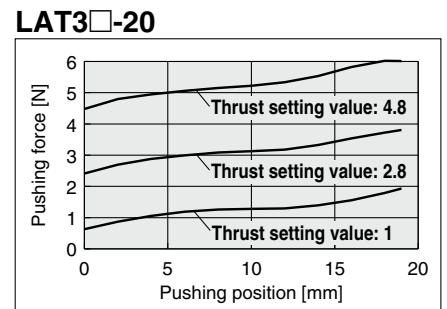
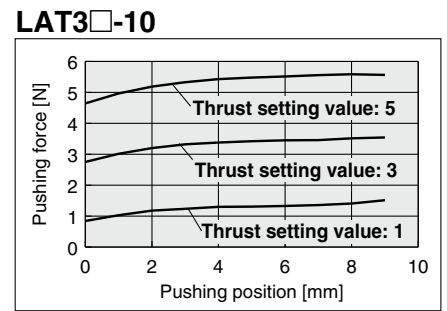

- LEFS
- LEFB
- LEJS
- LEJB
- LEL
- LEM
- LEMY
- LEYG
- LES
- LESH
- LEPY
- LEPS
- LER
- LEH
- LEH-X5
- LEY-X5
- 11-LEFS
- 11-LEJS
- 25A-
- LEC□
- JXC□
- LECS□
- LECS□-T
- LECY□
- Motorless
- LAT3

LAT3 Series

Table Displacement (Reference)

Displacement through the entire stroke when a load is applied to the point indicated by the arrow

Table displacement due to pitch moment load

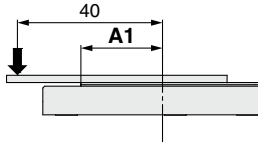

LAT3□-10, -20, -30, -50

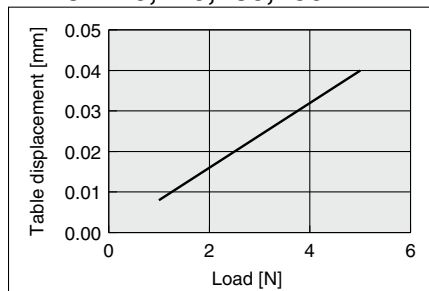
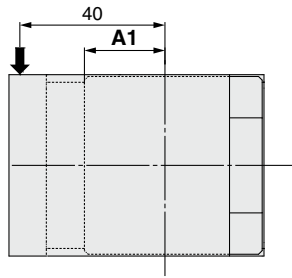

Table displacement due to yaw moment load



LAT3□-10, -20, -30, -50

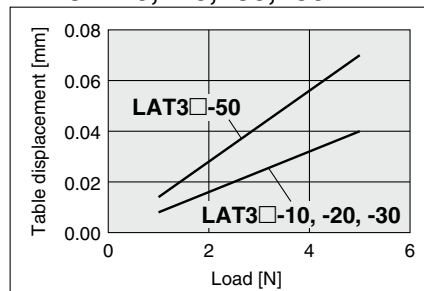
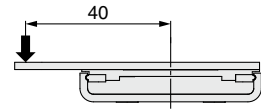

Table displacement due to roll moment load



LAT3□-10, -20, -30, -50

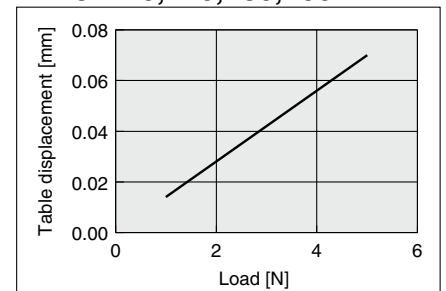

Table 2 Stroke: St [mm], Positioning Repeatability [μm], Measuring Accuracy [μm], Table Weight [g]

Model	LAT3-10	LAT3F-10	LAT3-20	LAT3F-20	LAT3-30	LAT3F-30	LAT3M-50	LAT3F-50
Stroke [mm]	10		20		30		50	
Positioning repeatability [μm]	±90	±5	±90	±5	±90	±5	±20	±5
Measuring accuracy [μm]	30	1.25	30	1.25	30	1.25	5	1.25
Table weight [g]	50		70		90		110	

Table 3 Allowable Moment: Mmax [N·m]

Model	Pitch moment/Yaw moment Mpmax, Mymax	Roll moment Mrmax
LAT3□-10	0.2	0.2
LAT3□-20	0.3	0.2
LAT3□-30	0.4	0.2
LAT3□-50	0.2	0.2

System Construction/General Purpose I/O

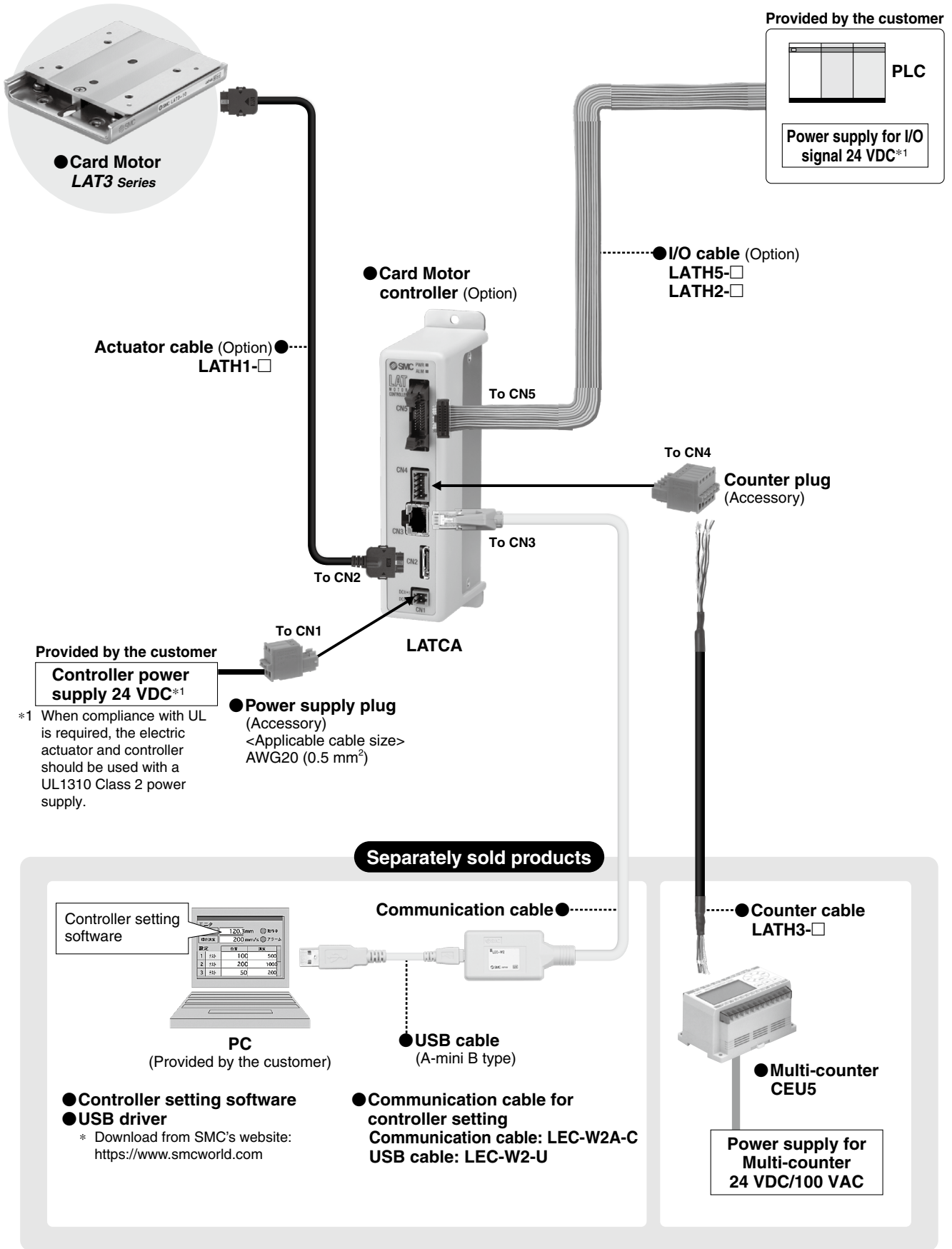

*1 When compliance with UL is required, the electric actuator and controller should be used with a UL1310 Class 2 power supply.

Separately sold products

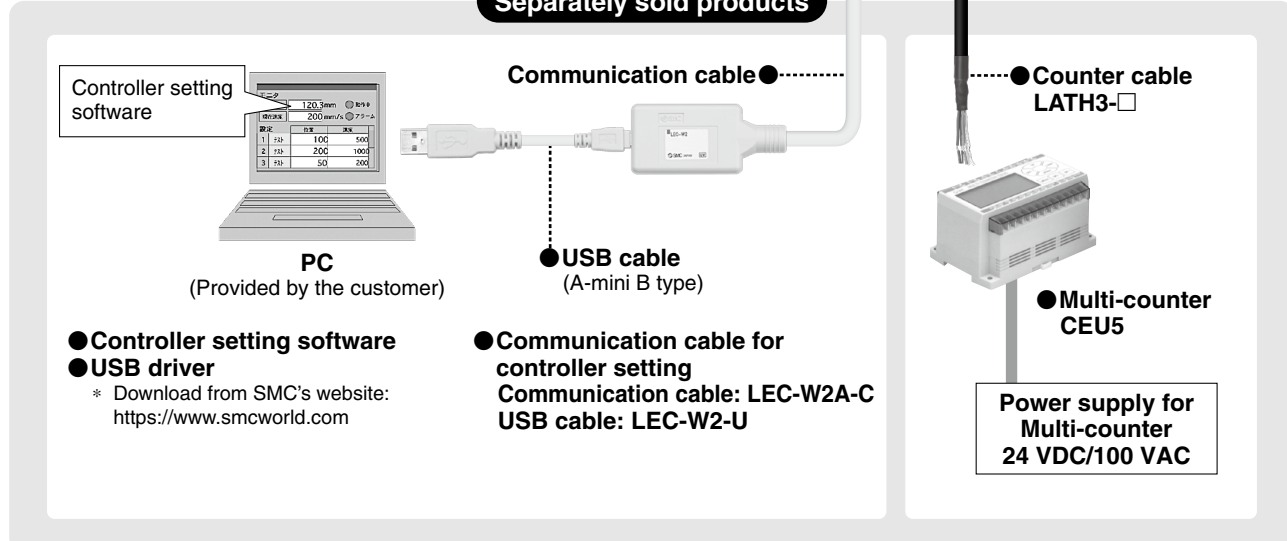

* Option: Can be ordered in the "How to Order" for the Card Motor
 * Accessory: Attached to the controller
 * Separately sold products: Order them separately. Refer to pages 971 to 974 for details.

- LEFS
- LEFB
- LEJS
- LEJB
- LEL
- LEM
- LEY
- LEYG
- LES
- LESH
- LEPY
- LEPS
- LER
- LEH
- LEY-X5
- 11-LEFS
- 11-LEJS
- 25A-
- LEC□
- JXC□
- LECS□
- LECS□-T
- LECY□
- Motorless
- LAT3

System Construction/Pulse Signal

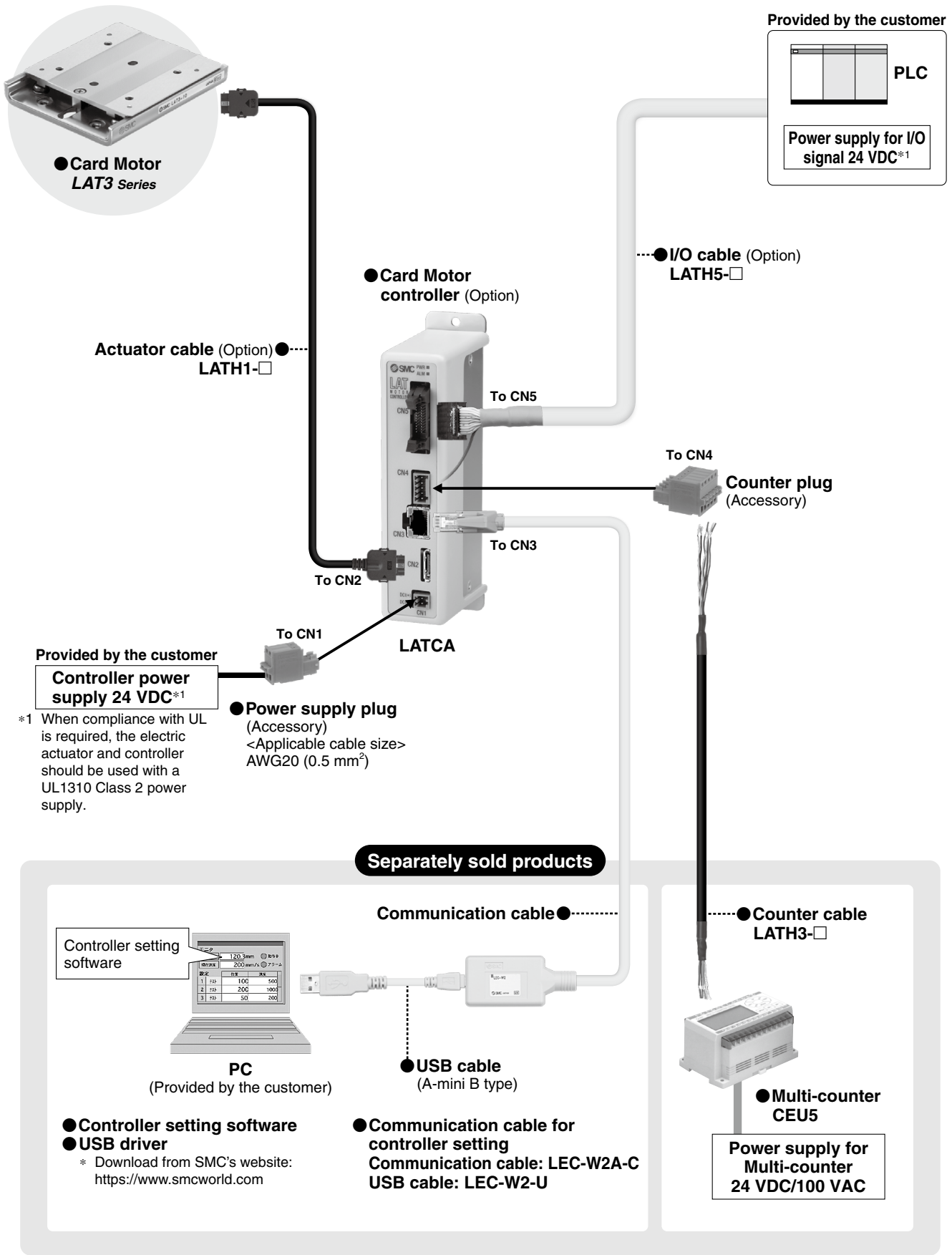

System Construction/Serial Communication (One Controller)

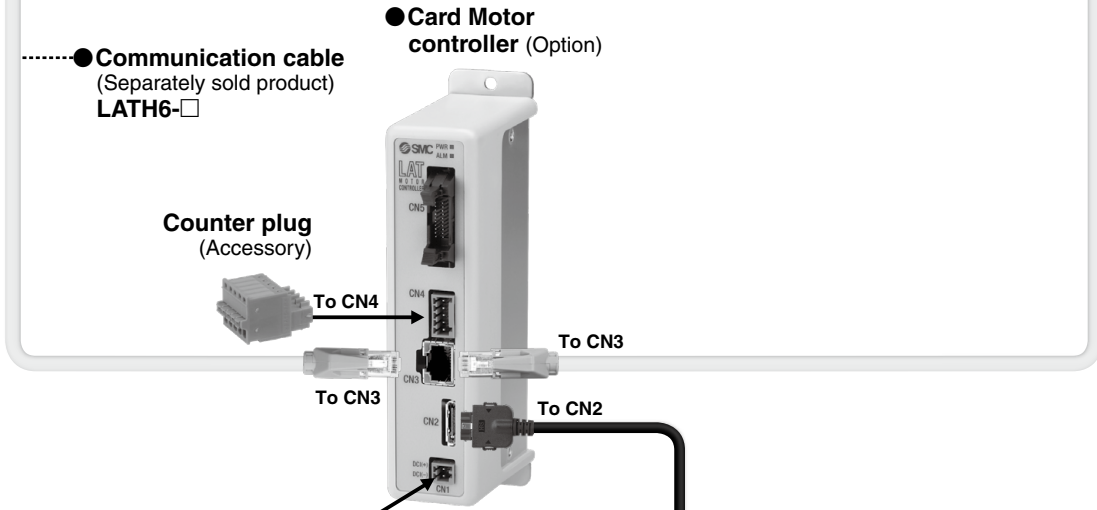
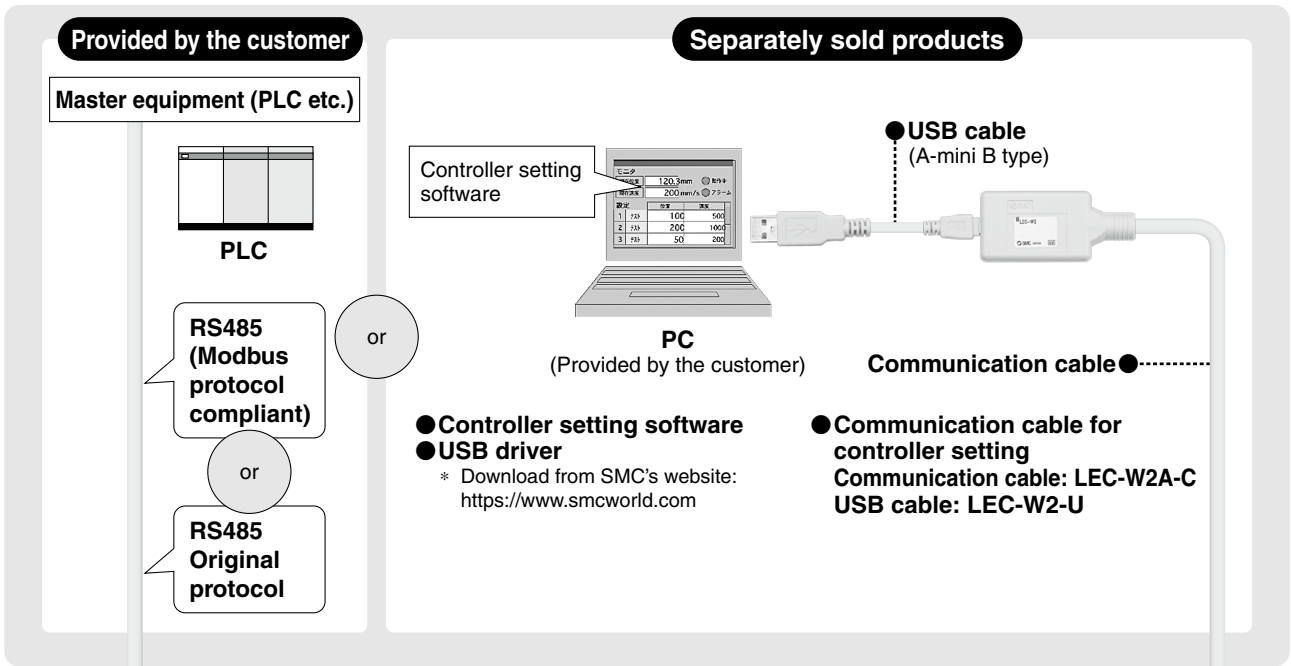

Provided by the customer

Controller power supply 24 VDC*1

*1 When compliance with UL is required, the electric actuator and controller should be used with a UL1310 Class 2 power supply.

● **Power supply plug** (Accessory)
<Applicable cable size>
AWG20 (0.5 mm²)

● **Actuator cable** (Option)
LATH1-□

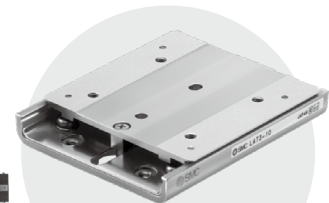

● **Card Motor**
LAT3 Series

* Option: Can be ordered in the "How to Order" for the Card Motor
 * Accessory: Attached to the controller
 * Separately sold products: Order them separately. Refer to pages 971 to 974 for details.

- LEFS
- LEFB
- LEJS
- LEJB
- LEL
- LEM
- LEY
- LEYG
- LES
- LESH
- LEPY
- LEPS
- LER
- LEH
- LEY-X5
- 11-LEFS
- 11-LEJS
- 25A-
- LEC□
- JXC□
- LECS□
- LECS□-T
- LECY□
- Motorless
- LAT3

System Construction/Serial Communication (2 to 16 Controllers)

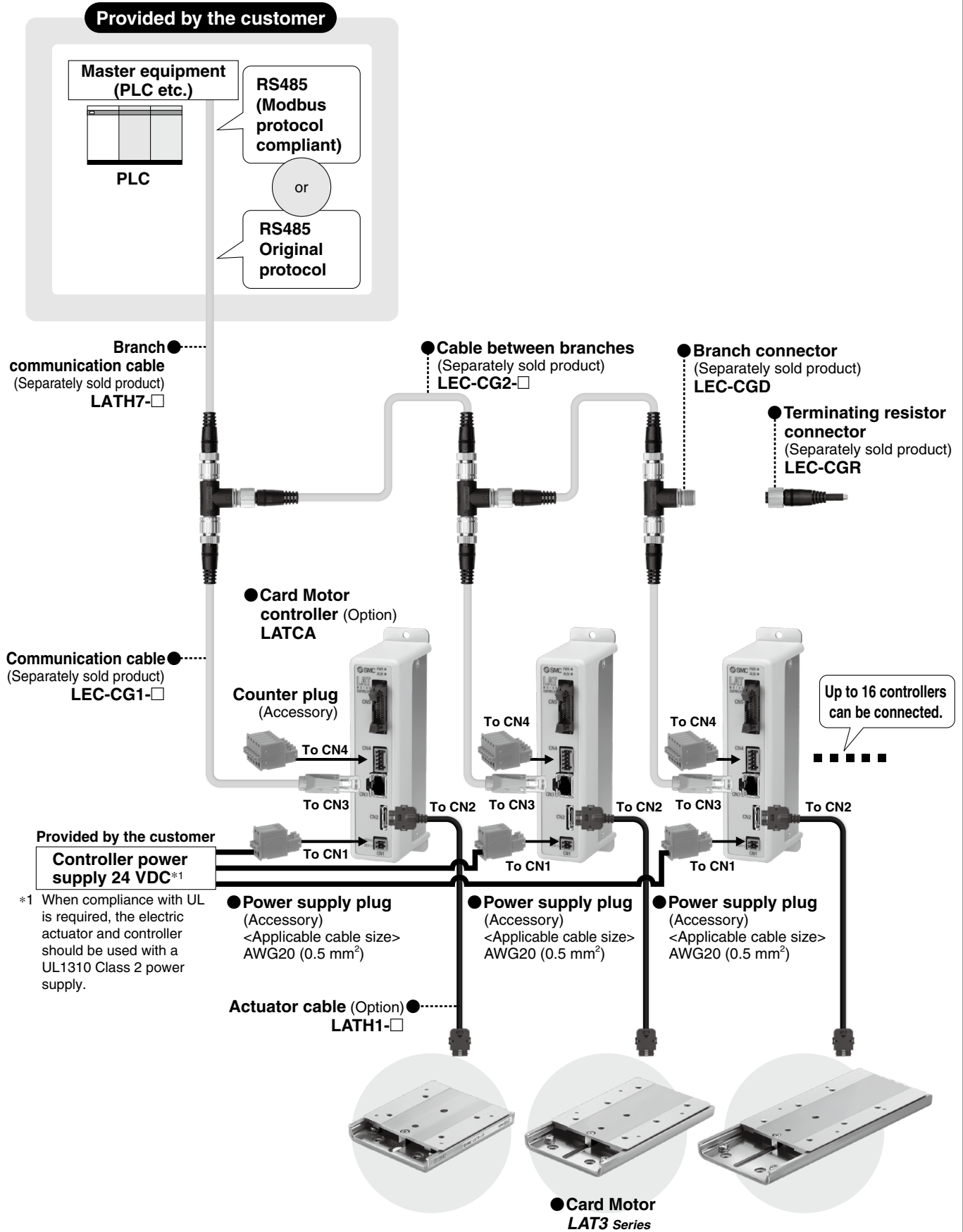

* Option: Can be ordered in the "How to Order" for the Card Motor
 * Accessory: Attached to the controller
 * Separately sold products: Order them separately. Refer to pages 971 to 974 for details.

Card Motor

LAT3 Series



How to Order

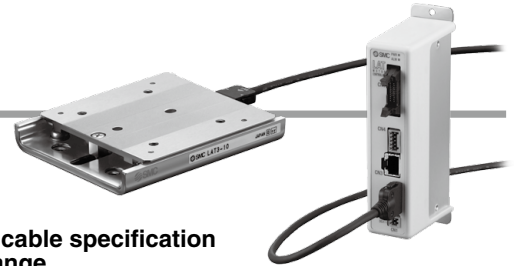

LAT3 F - 10 - 1 AN 1 D -

Card Motor

Sensor resolution

Nil	30 μm
M	5 μm
F	1.25 μm

Stroke

Model	Stroke			
	10 mm	20 mm	30 mm	50 mm
LAT3	○	○	○	—
LAT3M	—	—	—	○
LAT3F	○	○	○	○

○: Compatible —: Not compatible

Actuator cable length

Nil	Without cable
1	1 m
3	3 m
5	5 m

I/O cable specification change

Nil	No specification change
X152	Without shield*4

Controller mounting

Nil	Screw mounting
D*3	DIN rail

I/O cable length*2

Nil	Without cable
1	1 m
3	3 m
5	5 m

Controller*1

Nil	Without controller
AN	With controller LATCA (NPN)
AP	With controller LATCA (PNP)

*1 Refer to page 957 (LATCA) for detailed specifications of the controller.

*2 If "Without controller" has been selected, the I/O cable is also not included.

Therefore it is not possible to select the I/O cable for this option. If the I/O cable is required, please order it separately. (Refer to page 972, "I/O cable" for details.)

*3 The DIN rail is not included. If the DIN rail is required, please order it separately. (Refer to page 958, "DIN rail" and "DIN rail mounting adapter" for details.)

*4 The included I/O cable is changed from LATH5 to LATH2 (normally LATH5).

Specifications

Model		LAT3-10	LAT3F-10	LAT3-20	LAT3F-20	LAT3-30	LAT3F-30	LAT3M-50	LAT3F-50
Stroke [mm]		10		20		30		50	
Motor	Type	Moving magnet type linear motor							
	Maximum instantaneous thrust [N]*1 *2 *3	5.2		6		5.5		2.5	
	Continuous thrust [N]*1 *2 *3	3		2.8		2.6		1.5	
Guide	Type	Linear guide with circulating balls							
	Maximum load mass [g]	Horizontal: 1000, Vertical: 100				Horizontal: 1000, Vertical: 50		Horizontal: 1000, Vertical: Not possible	
Sensor	Type	Optical linear encoder (incremental)							
	Resolution [μm]	30	1.25	30	1.25	30	1.25	5	1.25
	Origin position signal	None	Provided	None	Provided	None	Provided	Provided	
Pushing operation	Pushing speed [mm/s]	6							
	Thrust setting value*1 *2 *3	1 to 5		1 to 4.8		1 to 3.9		1 to 2	
Positioning operation	Positioning resolution [μm]	30	1.25	30	1.25	30	1.25	5	1.25
	Positioning repeatability [μm]*4 *5	±90	±5	±90	±5	±90	±5	±20	±5
Measurement	Accuracy [μm]*4 *5	±100	±10	±100	±10	±100	±10	±40	±10
Maximum speed [mm/s]*6		400							
Operating temperature range [°C]		5 to 40 (No condensation)							
Operating humidity range [%]		35 to 85 (No condensation)							
Weight [g]*7		130		190		250		360	
Table weight [g]		50		70		90		110	

*1 Continuous thrust can be generated and maintained continuously. Maximum instantaneous thrust is the maximum peak thrust that can be generated. Refer to Fig. 4 Allowable thrust setting value (Page 948) and to Fig. 5 Pushing force characteristics (Page 948).

*2 When mounted on a base with good heat dissipating capacity at 20°C ambient temperature

*3 The pushing force varies depending on the operating environment, pushing direction and table position. Refer to Fig. 5 Pushing force characteristics (Page 948).

*4 When the temperature of the Card Motor is 20°C

*5 The accuracy after mounting the Card Motor may vary depending on the mounting conditions, operating conditions and environment, so please calibrate it with the equipment used in your application.

*6 The maximum speed varies depending on the operating conditions (load mass, positioning distance).

*7 The weight of the Card Motor itself. Controllers and cables are not included.

LEFS
LEFB

LEJS
LEJB

LEL

LEM

LEY
LEYG

LES
LESH

LEPY
LEPS

LER

LEH

LEY-X5

11-LEFS

11-LEJS

25A-

LEC

JXC

LECS
LECS-T

LECY

Motorless

LAT3

Card Motor Controller

(Step Data Input Type/Pulse Input Type)

LATCA Series



How to Order

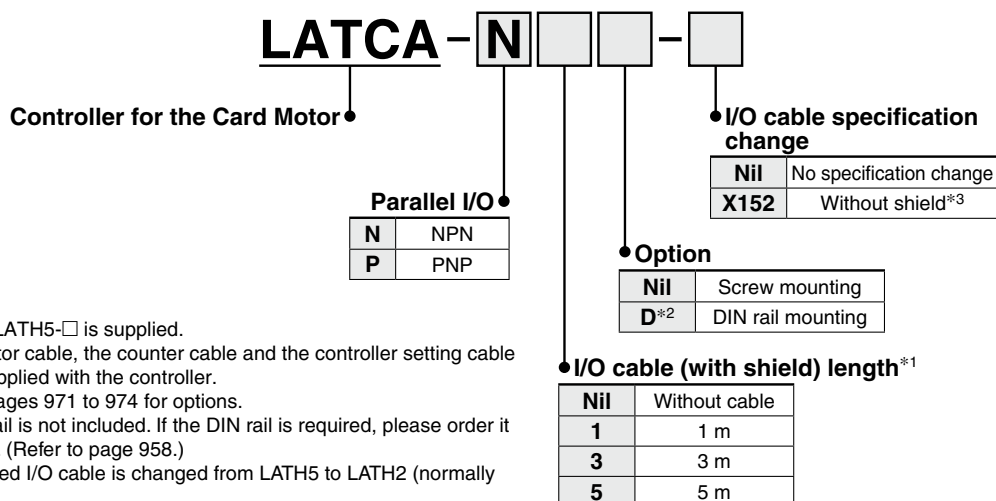

- *1 I/O cable LATH5-□ is supplied. The actuator cable, the counter cable and the controller setting cable are not supplied with the controller. Refer to pages 971 to 974 for options.
- *2 The DIN rail is not included. If the DIN rail is required, please order it separately. (Refer to page 958.)
- *3 The included I/O cable is changed from LATH5 to LATH2 (normally LATH5).

Specifications

Model	LATCA	
Setting method*1	Step data input type	Pulse input type
Compatible actuator	Card Motor LAT3 series	
Number of axis	1 axis	
Power supply*2	Power supply voltage: 24 VDC ±10%, Current consumption*3: Rated 2 A (Peak 3 A), Power consumption*3: Rated 48 W (Maximum 72 W)	
Control system	Closed loop	
Movement mode	Positioning operation, Pushing operation	
Number of step data	15 points	4 points
Parallel input	6 inputs (Optically isolated)	
Parallel output	4 outputs (Optically isolated, open collector output)	
Pulse input mode	—	Pulse and direction control mode CW and CCW control mode Quadrature control mode
Pulse signal input maximum frequency	—	100 kHz (Open collector) 200 kHz (Differential)
Position display output*4	A-phase and B-phase pulse signals, RESET signal (NPN open collector output)	
Serial communication	RS485 (Modbus protocol compliant), RS485 (Original protocol)	
Communication speed	2400 bps, 9600 bps, 19200 bps, 38400 bps, 57600 bps	
LED indicator	2 LED's (Green and Red)	
Cooling method	Natural air-cooling	
Operating temperature range	0 to 40°C (No condensation)	
Operating humidity range	90% or less (No condensation)	
Insulation resistance	Between case and FG: 50 MΩ (500 VDC)	
Weight*5	Screw mounting: 130 g, DIN rail mounting: 150 g	
Controller setting software*6	LATC-Configurator	
Setting cable	LEC-W2A-C, LEC-W2-U	

- *1 Either the step data input type or pulse input type can be selected after purchase.
- *2 For the controller, use a power supply which satisfies the max. current consumption and power consumption. However, be sure not to use an "inrush-current limited" type.
- *3 Rated current: Current consumption when continuous thrust is generated. Peak current: Current consumption when maximum instantaneous thrust is generated.
- *4 Specification for the connection of the separately sold multi-counter (CEU5).
- *5 Cables are not included.
- *6 The controller setting software can be downloaded via the SMC website: <https://www.smcworld.com>

How to Mount

a) Screw mounting (LATCA-□□) (Installation with two M4 screws)

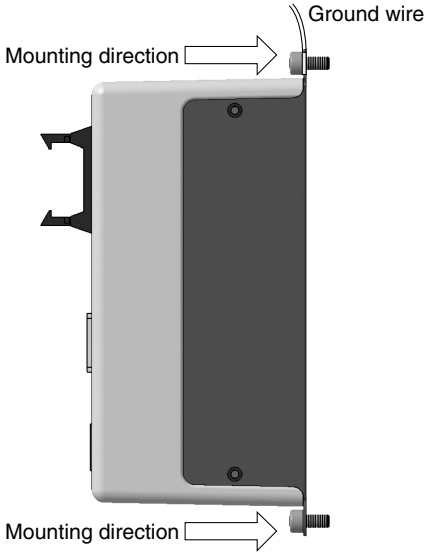

b) DIN rail mounting (LATCA-□□D) (Installation with the DIN rail)

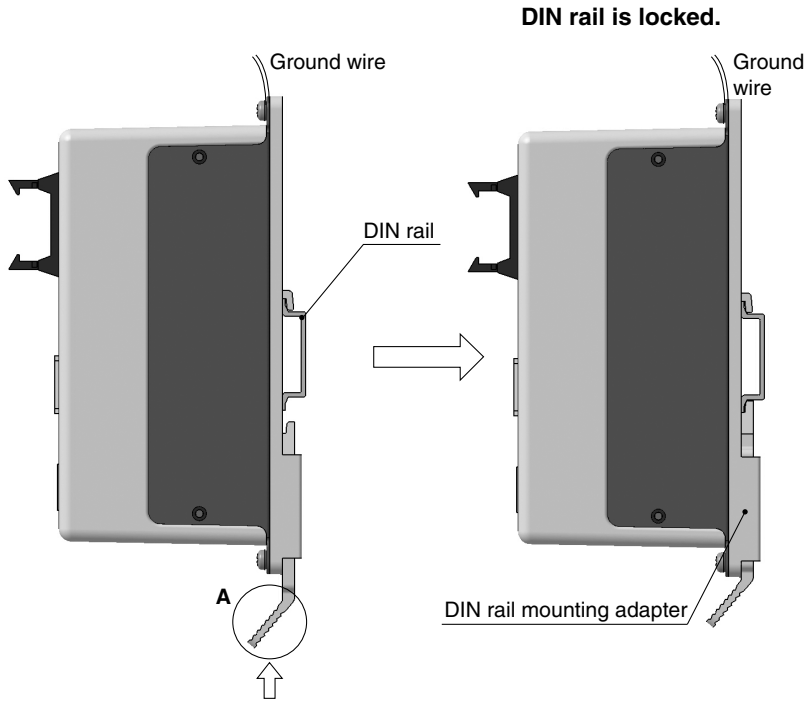

Hook the controller on the DIN rail and press the lever of section **A** in the arrow direction to lock it.

DIN rail AXT100-DR-□

* For □, enter a number from the "No." line in the table below.
Refer to the dimension drawings on page 959 for the mounting dimensions.

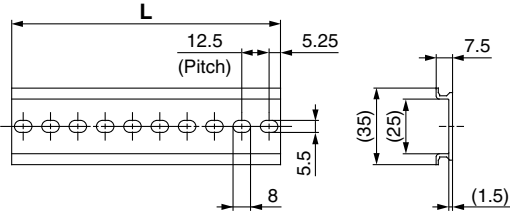

L Dimensions

No.	1	2	3	4	5	6	7	8	9	10	11	12	13	14	15	16	17	18	19	20
L	23	35.5	48	60.5	73	85.5	98	110.5	123	135.5	148	160.5	173	185.5	198	210.5	223	235.5	248	260.5
No.	21	22	23	24	25	26	27	28	29	30	31	32	33	34	35	36	37	38	39	40
L	273	285.5	298	310.5	323	335.5	348	360.5	373	385.5	398	410.5	423	435.5	448	460.5	473	485.5	498	510.5

DIN rail mounting adapter LEC-D0 (with 2 mounting screws)

The DIN rail mounting adapter can be retrofitted onto a screw mounting type controller.

- LEFS
- LEFB
- LEJS
- LEJB
- LEL
- LEM
- LEY
- LEYG
- LES
- LESH
- LEPY
- LEPS
- LER
- LEH
- LEY-X5
- 11-LEFS
- 11-LEJS
- 25A-
- LEC□
- JXC□
- LECS□
- LECS□-T
- LECY□
- Motorless
- LAT3

LATCA Series

Dimensions

a) Screw mounting (LATCA-□□)

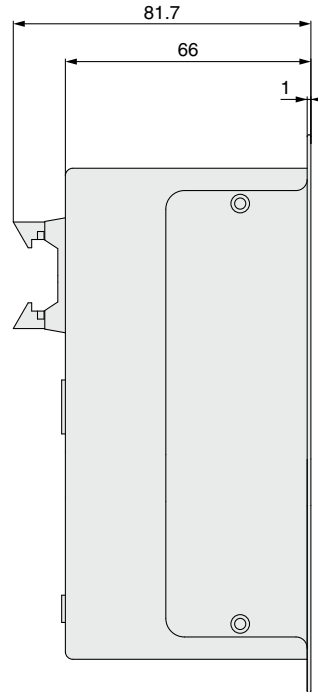
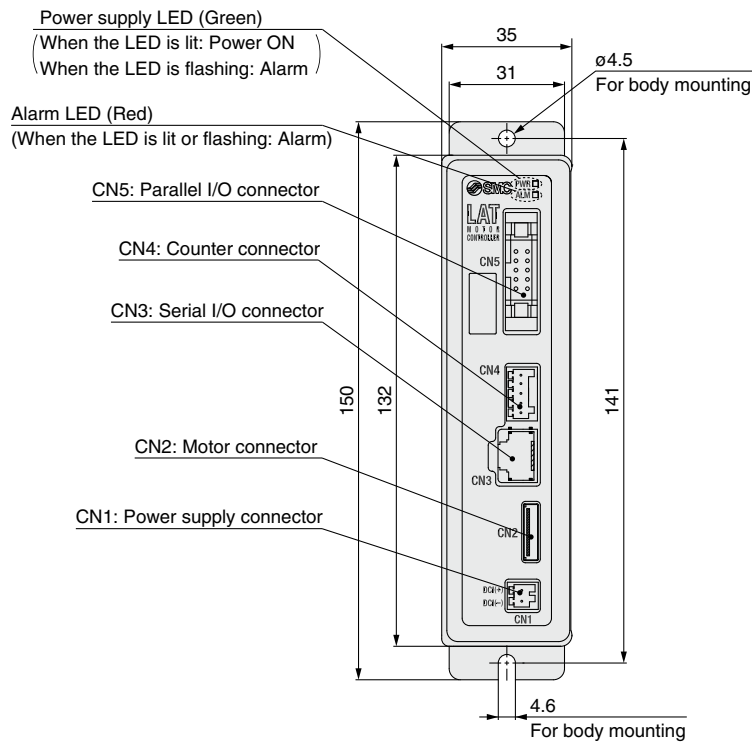

b) DIN rail mounting (LATCA-□□D)

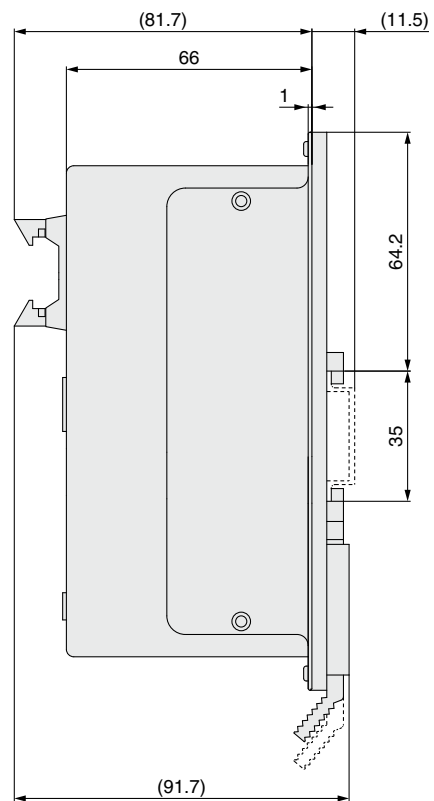
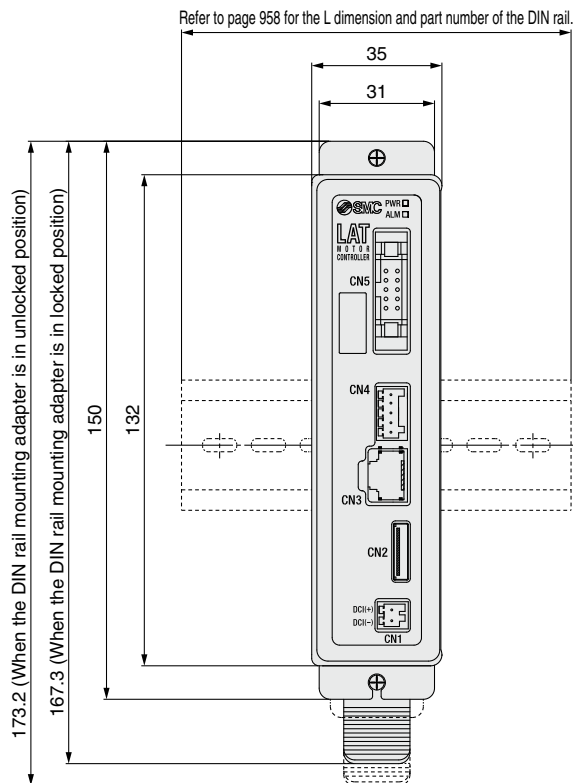

* When two or more controllers are used,
the space between the controllers should be 10 mm
or more.

Wiring Example

Power Supply Connector: CN1

* The power supply plug is an accessory (supplied with the controller).
Use an AWG20 (0.5 mm²) cable for connecting the power supply plug to a 24 VDC power supply.

Power Supply Connector Terminal

Terminal name	Function	Details
DC1(-)	Power supply(-)	The negative (-) power supply terminal to the controller. Power (-) is also supplied to the Card Motor via the internal circuit of the controller and actuator cable.
DC1(+)	Power supply(+)	The positive (+) power supply terminal to the controller. Power (+) is also supplied to the Card Motor via the internal circuit of the controller and actuator cable.

Power supply plug

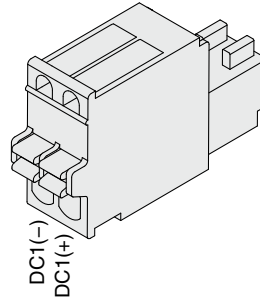

Counter plug

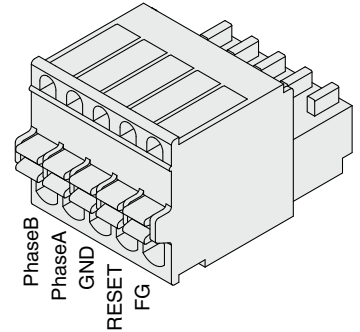

Counter Connector: CN4

* The counter plug is an accessory (supplied with the controller).
* Use the counter cable (LATH3-□) for connecting the counter to the counter plug.

Counter Connector Terminal

Name	Details	Cable color
PhaseB	Connect to the phase B wire of the counter cable.	White
PhaseA	Connect to the phase A wire of the counter cable.	Red
GND	Connect to the GND wire of the counter cable.	Light gray
RESET	Connect to the Reset wire of the counter cable.	Yellow
FG	Connect to the FG wire of the counter cable.	Green

Parallel I/O Connector: CN5

* Use the I/O cable (LATH5-□) to connect a PLC, etc., to the CN5 parallel I/O connector.
* The wiring is specific to the type of parallel I/O (NPN or PNP). Refer to the wiring diagrams below for correct wiring of NPN and PNP type controllers.

■ NPN

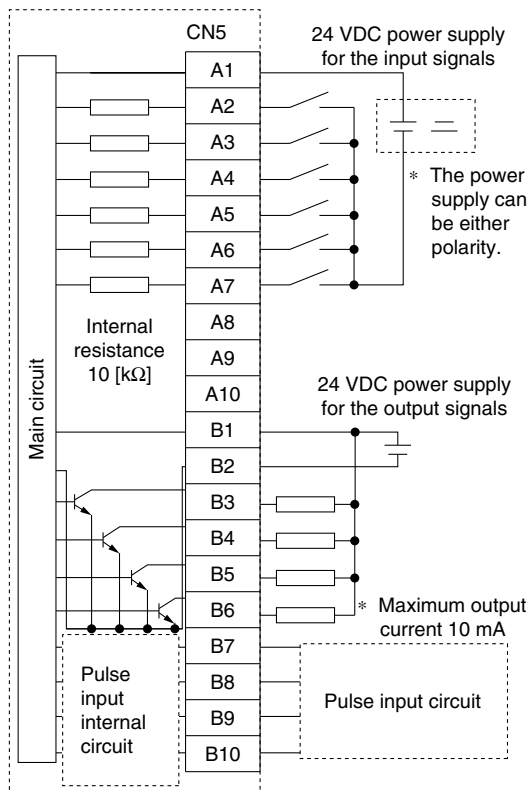

■ PNP

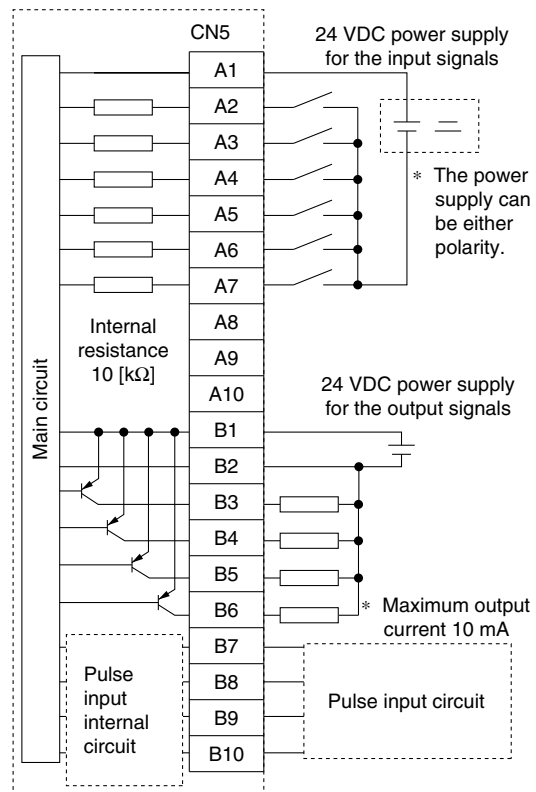

* When using the controller by the step data input type, do not wire as there is an internal circuit to use terminals B7 to B10 as the pulse signal input terminals.

LEFS
LEFBLEJS
LEJB

LEL

LEM

LEY
LEYGLES
LESHLEPY
LEPS

LER

LEH

LEY-X5

11-LEFS

11-LEJS

25A-

LEC□

LECS□
LECS□-T

LECY□

Motorless

LAT3

LATCA Series

Wiring Example

Step Data Input Type

Input/Output Signal

Terminal no.	Input/Output	Function	Details
A1	Input	COM	Connect a 24 VDC power supply for the input signals. (Polarity is reversible)
A2		INO	Selection of step data number specified by a Bit No. (combinations of IN0 to IN3)
A3		IN1	
A4		IN2	
A5		IN3	Command to drive the motor
A6		DRIVE	
A7		SVON	Command to turn the servo motor ON
A8		NC	Not connected
A9		NC	Not connected
A10		NC	Not connected
B1	Output	DC2(+)	Connect the 24 V power supply terminal for the output signals.
B2		DC2(-)	Connect the 0 V power supply terminal for the output signals.
B3		BUSY	ON when the actuator is moving*1
B4		ALARM	OFF when alarm is generated*2
B5		OUT0	Select an output function among BUSY, INP, INFP, INF, AREA A, AREA B, OVC, and OVT.*3
B6		OUT1	
B7	Input	NC	Not connected
B8		NC	Not connected
B9		NC	Not connected
B10		NC	Not connected

- *1 Other output functions can also be assigned to the BUSY output.
- *2 This output signal turns ON when power is supplied to the controller, but turns OFF in alarm condition (N.C.).
- *3 INP is set as a default for OUT0, and INF for OUT1.

Pulse Input Type

Input/Output Signal

Terminal no.	Input/Output	Function	Details
A1	Input	COM	Connect a 24 VDC power supply for the input signals. (Polarity is reversible)
A2		INO	Selection of step data number specified by a Bit No. (combinations of IN0 and IN1)
A3		IN1	
A4		SETUP	Instruction to return to origin
A5		CLR	Deviation reset
A6		TL	Instruction to pushing operation
A7		SVON	Command to turn the servo motor ON
A8		NC	Not connected
A9		NC	Not connected
A10		NC	Not connected
B1	Output	DC2(+)	Connect the 24 V power supply terminal for the output signals.
B2		DC2(-)	Connect the 0 V power supply terminal for the output signals.
B3		BUSY	ON when the actuator is moving*1
B4		ALARM	OFF when alarm is generated*2
B5		OUT0	Select an output function among BUSY, INP, INFP, INF, AREA A, AREA B, OVC, and OVT.*3
B6		OUT1	
B7	Input	PP+	Connect the pulse input signal*4
B8		PP-	
B9		NP+	
B10		NP-	

- *1 Other output functions can also be assigned to the BUSY output.
- *2 This output signal turns ON when power is supplied to the controller, but turns OFF in alarm condition (N.C.).
- *3 INP is set as a default for OUT0, and INF for OUT1.
- *4 The function assignment changes according to the pulse input mode.

Pulse Input Circuit Example

Pulse signal output of positioning unit is open collector output

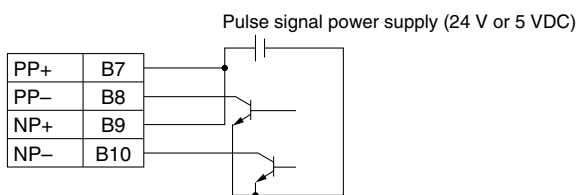

Pulse signal output of positioning unit is differential output

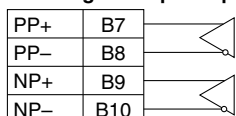

OUT0 and OUT1 Optional Output Functions*4

Name	Details
BUSY	ON when the actuator is moving*1
INP	ON when the table is within the "INP" output range of the current "Target Position."
INFP	ON when the table is within the positioning repeatability range of the actuator for the current "Target Position."
INF	ON when the pushing force is within the "Threshold Force Value."
AREA A, AREA B	ON when the table is within the set "Area Ranges."
OVC	ON when the set current has been exceeded
OVT	ON when the set temperature has been exceeded

*4 One output function can be selected for each OUT0 and OUT1.

Pulse Input Internal Circuit

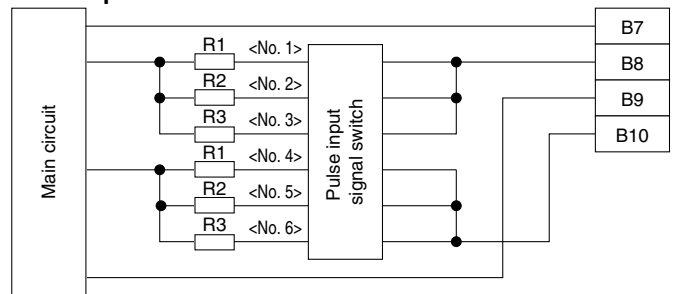

	Signal input method	Pulse input signal power supply voltage	Pulse input signal switch setting	Current limiting resistor R specifications
(a)	Open collector input	24 VDC $\pm 10\%$	No. 2 & No. 5: ON, Others: OFF	R2 = 1.5 k Ω
(b)	Open collector input	5 VDC $\pm 5\%$	No. 1 & No. 4: ON, Others: OFF	R1 = 220 Ω
(c)	Differential input	—	No. 3 & No. 6: ON, Others: OFF	R3 = 120 Ω

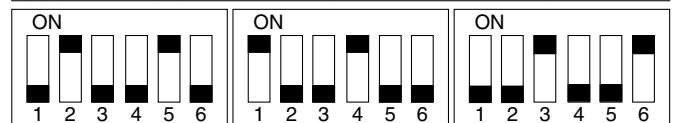

Change the switch in the controller according to the pulse input signal power supply voltage. For differential input, connect the positioning unit using the line driver which is equivalent to DS26C31.

Pulse Input Mode

Table moves to opposite side of connector | Table moves to connector side

Pulse and direction control mode

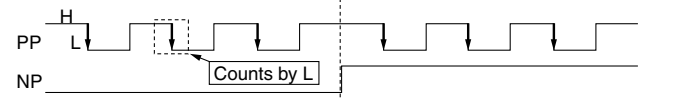

CW and CCW control mode

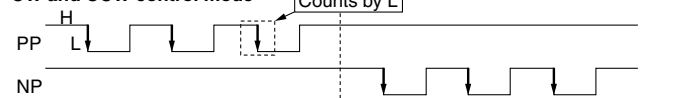

Quadrature control mode



Signal Timing (When step data input type is selected)

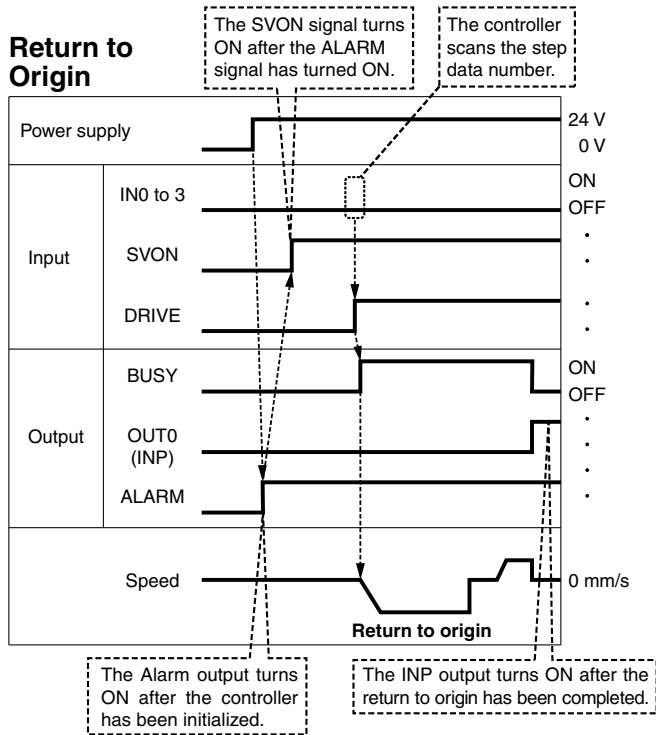

* "ALARM" is expressed as a negative-logic circuit.

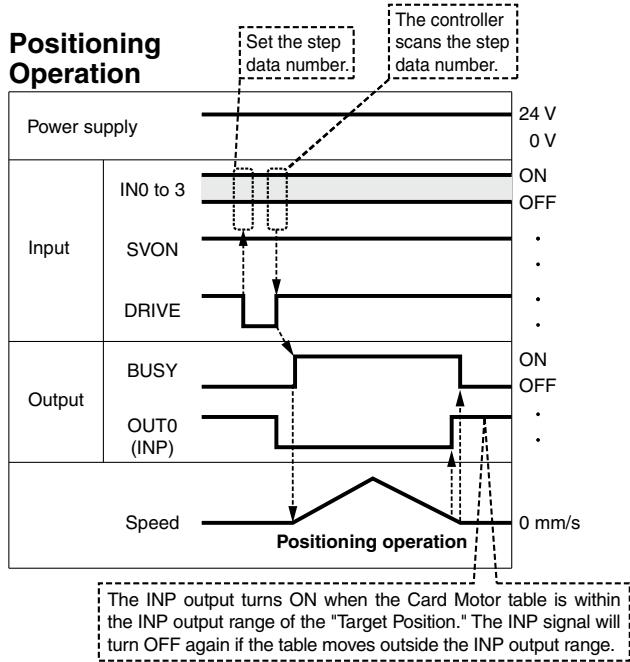

AREA Signal

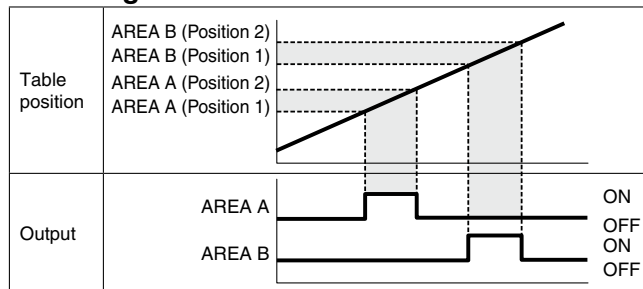

* Select the AREA signal for the parallel output signal (OUT0 or OUT1).

⚠ Caution

- Use a 2 ms interval or more between input signals, and maintain the signal state for at least 2 ms.
- Turn ON the SVON signal first after that the ALARM signal has turned ON after power has been supplied to the controller. If the SVON signal is already ON, the operation will not start for safety reasons.
- Keep the DRIVE signal turned ON until the next operation instruction is given except when stopped during operation.
- When the DRIVE signal is turned OFF during positioning operation, the table of the Card Motor stops, and holds the position.
- When the DRIVE signal is turned OFF during pushing operation, the pushing operation is completed and this position is retained.
- When using a multi-counter, after [Return to Origin] has been performed, turn the DRIVE signal OFF for 300 ms or more to allow for the counter to be reset. If the table is moved before the counter has been reset, a deviation in the multi-counter's displayed value may occur.

Pushing Operation

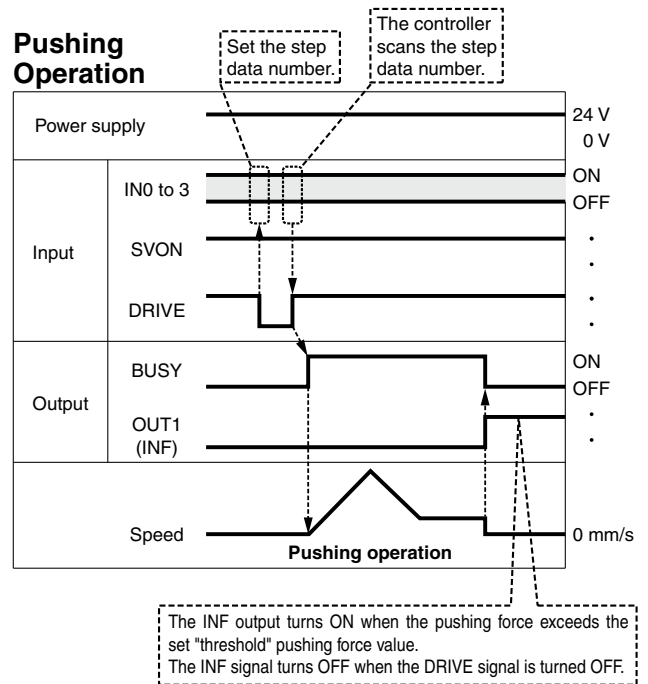

Alarm Reset

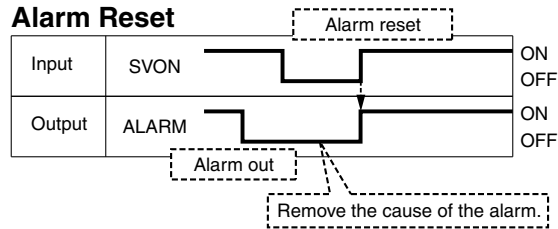

* "ALARM" is expressed as a negative-logic circuit.

LEFS
LEJB
LEJ
LEM
LEYG
LESH
LEPS
LER
LEH
LEY-X5
11-LEFS
11-LEJS
25A-
LEC
JXC
LECS
LECS-T
LECY
Motorless
LAT3

LATCA Series

Signal Timing (When pulse input type is selected)

Return to Origin

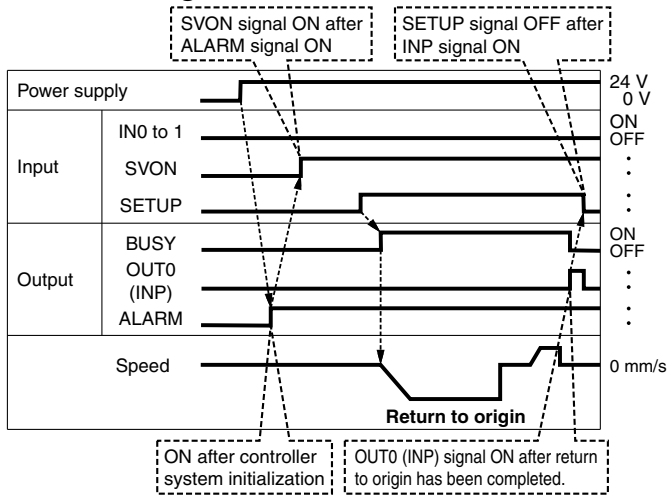

* "ALARM" is expressed as a negative-logic circuit.

Positioning Operation

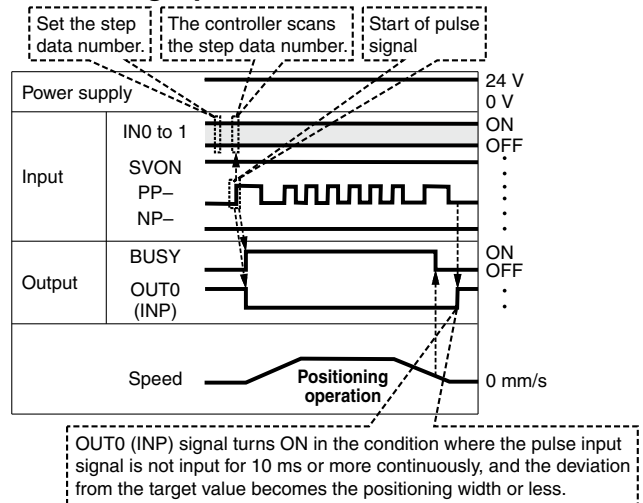

Caution

- Turn ON the SVON signal first after that the ALARM signal has turned ON after power has been supplied to the controller. If the SVON signal is already ON, the operation will not start for safety reasons.
- During the return to origin, do not input a pulse input signal until the SETUP signal has turned OFF. Pulse input signals input while the SETUP signal is turned ON will be invalidated. In addition, when using a multi-counter, turn the SETUP signal OFF and then wait for 300 ms or more before inputting a pulse signal. If the table is moved before the counter has been reset, a deviation in the multi-counter's displayed value may occur.
- Do not input the pulse signals PP and NP at the same time in the CW and CCW control mode.
- When changing the moving direction of the actuator, be sure to leave an interval of 10 [ms] or more, and input a pulse signal of reverse direction.
- After the IN0 and IN1 signals are changed, leave an interval of 10 ms or more, then input a pulse signal.

Pushing Operation

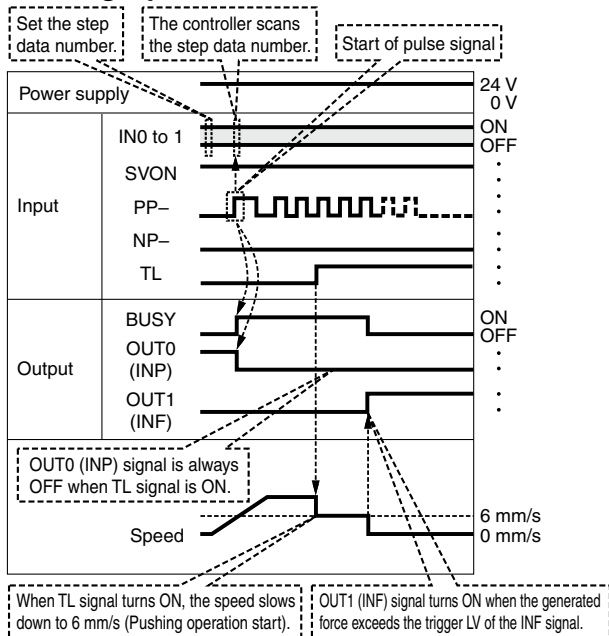

When TL signal turns ON, the speed slows down to 6 mm/s (Pushing operation start).
OUT1 (INF) signal turns ON when the generated force exceeds the trigger LV of the INF signal.

Operation after Pushing Operation

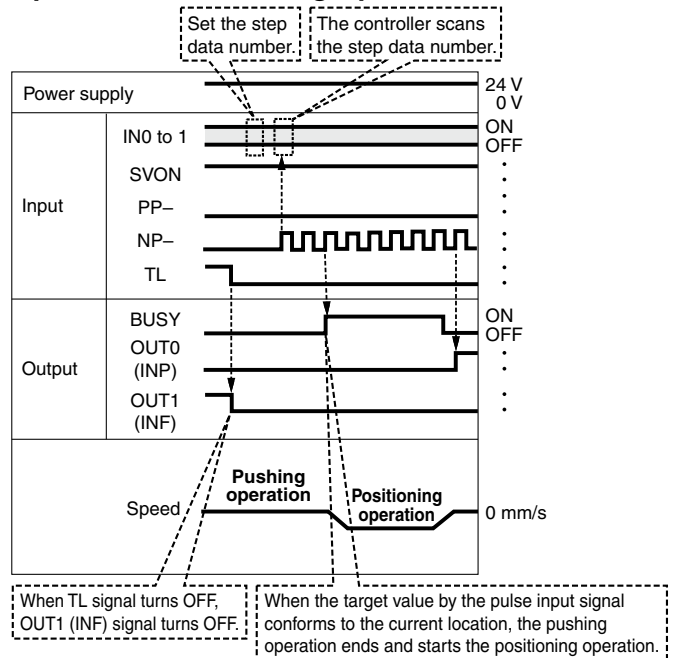

When TL signal turns OFF, OUT1 (INF) signal turns OFF.
When the target value by the pulse input signal conforms to the current location, the pushing operation ends and starts the positioning operation.

AREA Signal

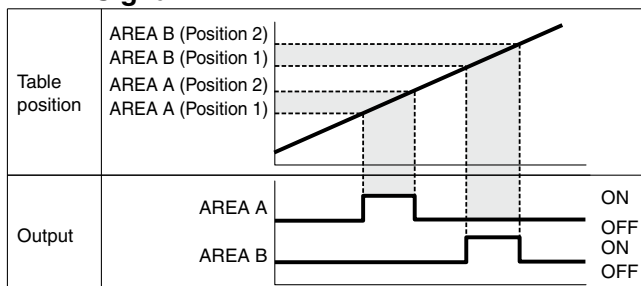

* Select the AREA signal for the parallel output signal (OUT0 or OUT1).

Alarm Reset

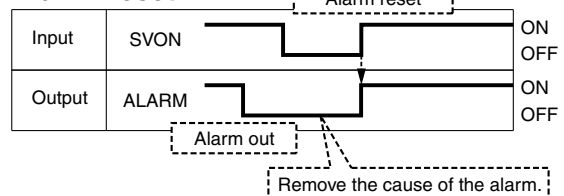

* "ALARM" is expressed as a negative-logic circuit.

Serial Communication

Communication Specifications

Item	Details	
Protocol*1	Original, Modbus	
Communication data	ASCII, RTU*2 *3	
Node type	Slave (Controller)	
Error checking	None	
Frame size	Variable length: Max. 128 bytes	
Communication method	RS485, asynchronous system	
	Communication speed	2400 bps, 9600 bps, 19200 bps, 38400 bps, 57600 bps*4
	Data bit	8 bit
	Parity	Even parity
	Stop bit	1 bit
	Flow control	None

*1 The protocol is recognized automatically.

*2 RTU is only compatible with Modbus.

*3 Modbus protocol automatically recognizes both ASCII and RTU.

*4 The product is set to 19200 bps at the time of shipment from the factory. After purchase, it is possible to change to one of the other communication speeds.

Function

① **Setting of step data**

The contents of the step data such as the target position and positioning time can be set.

② **Acquisition of operation information**

Information such as the status of a parallel I/O signal and table position can be acquired.

③ **Step data operation**

Without inputting a parallel I/O signal, the step data number can be selected from the communication device of the PLC, etc. via serial communication to specify the operation.

④ **Direct operation**

Operation can be executed by setting the target position, positioning time, etc. each time.

Caution

Use the controller setting software to set the basic settings (refer to the following) of the controller.

1. Select input type.
2. Card Motor product number
3. Return to origin method
4. Step data input method
5. Card Motor mounting orientation
6. Set the controller ID. (Set to "1" at the time of shipment)
7. Select output signal.

LEFS
LEFB

LEJS
LEJB

LEL

LEM

LEY
LEYG

LES
LESH

LEPY
LEPS

LER

LEH

LEY-X5

11-LEFS

11-LEJS

25A-

LEC

JXC

LECS
LECS-T

LECY

Motorless

LAT3

LATCA Series

Step Data Setting Methods and Movement Profiles

There are two methods for setting the step data in the Card Motor controller as described below.

Cycle time entry method

To operate the table based on the target position and positioning time, or to operate it at high frequency. The speed, acceleration and deceleration are calculated automatically after the target position and positioning time have been set.

Speed entry method

To operate the table at a constant speed. The table moves to the set target position based on the set speed, acceleration and deceleration.

Cycle Time Entry Method (Positioning Operation)

Setting items: **Target position [mm]** **Positioning time [s]** **Load mass [g]**

Calculate the positioning distance S [mm] between the start position and the target position. The table will move to the target position based on the set positioning time t_p [s] according to a triangular movement profile as shown in the diagram on the right.

* It is not necessary to enter the speed, acceleration and deceleration since they are calculated automatically by the Card Motor Controller Setting Software.

The positioning time should be set longer than the shortest positioning time shown in **Fig. 3** on page 947 with consideration to the load mass during the operation. If there is overshoot or vibration, set the positioning time longer.

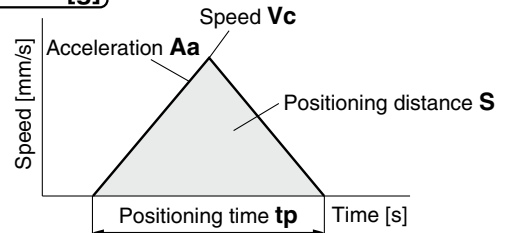

Speed Entry Method (Positioning Operation)

Setting items: **Target position [mm]** **Speed [mm/s]** **Acceleration [mm/s²]** **Deceleration [mm/s²]** **Load mass [g]**

Calculate the positioning distance S [mm] between the start position and the target position. The table will move to the target position based on the set speed V_c [mm/s], acceleration A_a [mm/s²] and deceleration A_d [mm/s²] according to a trapezoidal movement profile as shown in the diagram on the right.

Refer to the equations below for how to calculate the acceleration, constant velocity and deceleration times and distances.

Acceleration time: $t_a = V_c / A_a$ [s]

Deceleration time: $t_d = V_c / A_d$ [s]

Acceleration distance: $S_a = 0.5 \times A_a \times t_a^2$ [mm]

Deceleration distance: $S_d = 0.5 \times A_d \times t_d^2$ [mm]

Distance with constant velocity: $S_c = S - S_a - S_d$ [mm]

Time with constant velocity: $t_c = S_c / V_c$ [s]

Positioning time: $t_p = t_a + t_c + t_d$ [s]

(Add settling time*1 to the positioning time to obtain the real cycle time.)

*1 The settling time varies depending on the positioning distance and load mass. 0.15 seconds (0.25 seconds for the load mass of 500 g or more) at maximum can be used as a reference value.

The acceleration and deceleration should be smaller than the maximum acceleration/deceleration with consideration to the load mass during the operation as specified in the diagram on the right.

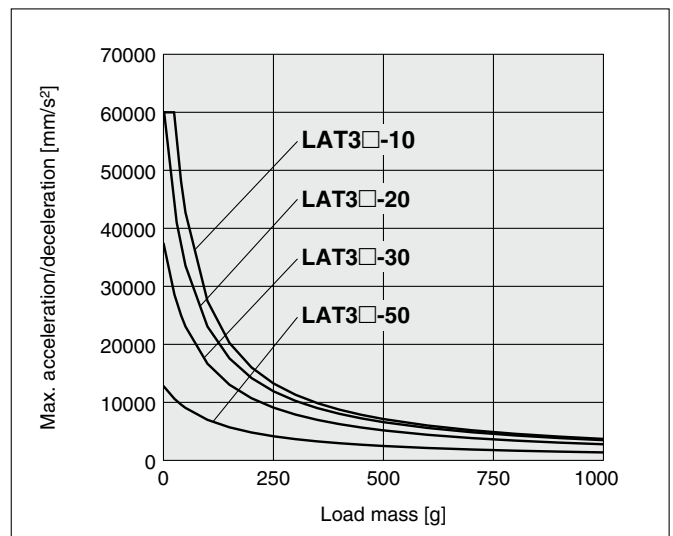
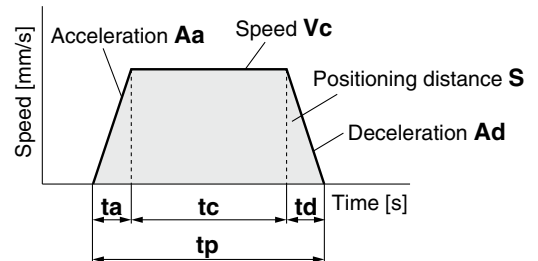

⚠ Caution

If the acceleration/deceleration is low, the table may not reach the set speed due to a triangular movement profile.

Cycle Time Entry

The controller automatically calculates the speed, acceleration and deceleration after the user has entered how many seconds it should take for the Card Motor table to move to the target position. Therefore, there is no need to enter the speed, acceleration and deceleration.

Cycle Time Entry Method

Step 1 Basic settings

Set each item described below and register it to the controller by clicking [Setup].

- A** [Card Motor Product Number]: Enter the product number of the connected Card Motor.
- B** [Return to Origin Method]: Select origin method and position.
- C** [Card Motor Mounting Orientation]: Select horizontal or vertical.
- D** [Step Data Input Method]: Select cycle time entry method

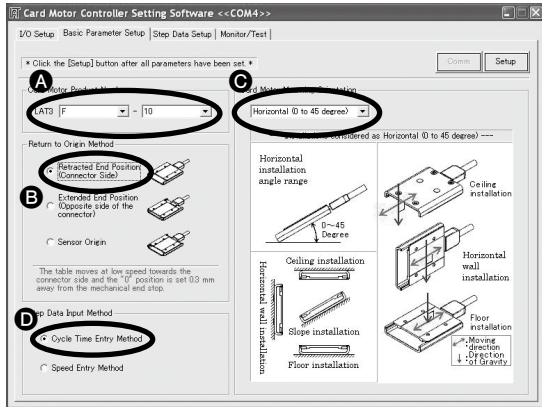

Step 2 Setting of the operating conditions - Selection of operation type-

- B** Select the [Step Data Setup] tab.
- F** Select "Operation" type.
 - Position** For transporting a workpiece to a specific position
 - Pushing** For applying force to a workpiece or for measuring the size of a workpiece

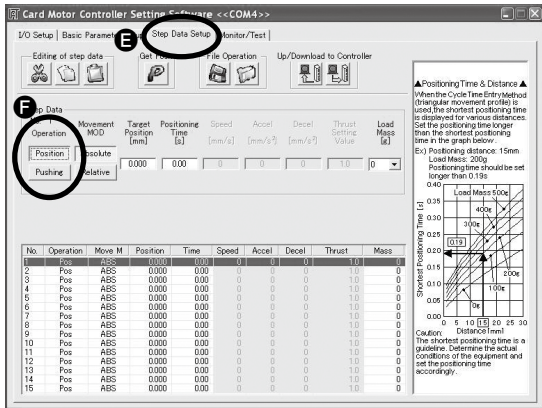

Step 3 Setting of the operating conditions - Entering of the operating values-

<Positioning operation>

- Items to enter
- G** **Target position [mm]** Distance from the origin position (or current position) to the target position
 - H** **Positioning time [s]** Time required to move to the target position
 - I** **Load mass [g]** Select the approximate weight of attachment or workpieces mounted on the Card Motor table.

<Pushing operation>

- Items to enter
- G** **Target position [mm]**
 - H** **Positioning time [s]**
 - I** **Load mass [g]**
 - J** **Thrust setting value** Force to be applied

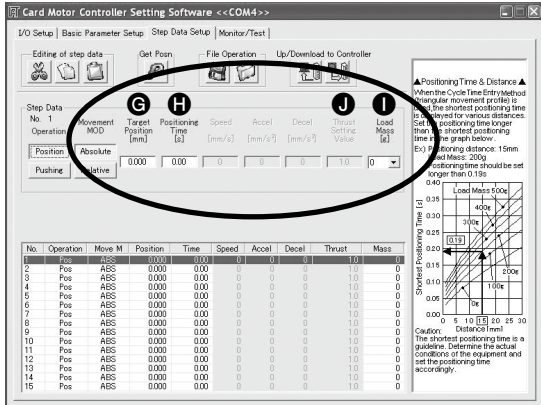

Step 4 Download the completed settings

- After the operating conditions have been set,
- K** Click the [Download] button to complete the settings.

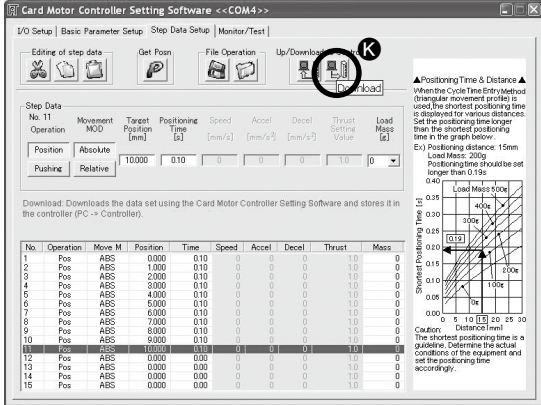

* Refer to the Operation Manual for details.

- LEFS
- LEFB
- LEJS
- LEJB
- LEL
- LEM
- LEM
- LEY
- LEYG
- LES
- LESH
- LEPY
- LEPS
- LER
- LEH
- LEH
- LEY-X5
- 11-LEFS
- 11-LEJS
- 11-LEJS
- 25A-
- LEC
- JXC
- LECS
- LECS-T
- LECY
- Motorless
- LAT3

LATCA Series

Operation Modes

The Card Motor controller has two operation modes as described below.

Position For transporting a workpiece to a specific position

Pushing For applying force to a workpiece or for measuring the size of a workpiece

Positioning Operation

Cycle Time Entry Method: The acceleration and deceleration are automatically calculated based on the set positioning time, and the table moves according to a triangular movement profile ① and stops at the set target position ②.

Speed Entry Method: The table moves based on the set acceleration, speed and deceleration according to a trapezoidal movement profile ① and stops at the target position ②.

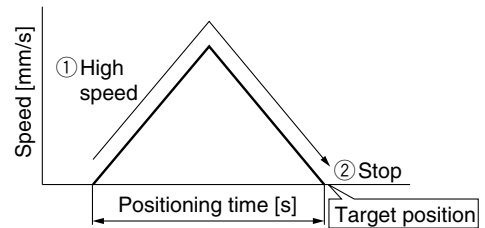
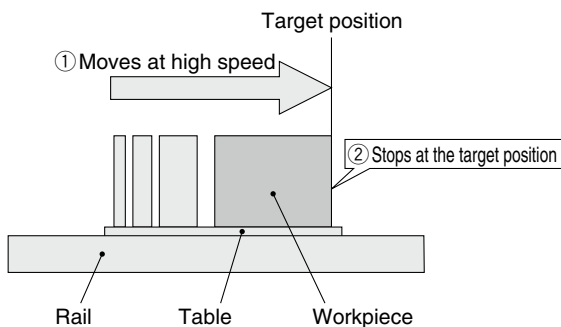

Movement profile for the Cycle Time Entry Method (Triangular)

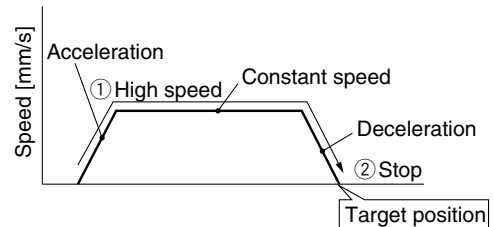

Movement profile for the Speed Entry Method (Trapezoidal)

Pushing Operation

Cycle Time Entry Method: The acceleration and deceleration are automatically calculated based on the set positioning time, and the table moves according to a triangular movement profile close to the target position ①, and continues to move at low speed (6 mm/s) until it comes into contact with the workpiece ②. After the table has come into contact with the workpiece the Card Motor presses the workpiece ③.

Speed Entry Method: The table moves based on the set acceleration, speed and deceleration according to a trapezoidal movement profile close to the target position ①, and continues to move at low speed (6 mm/s) until it comes into contact with the workpiece ②. After the table has come into contact with the workpiece the Card Motor presses the workpiece ③.

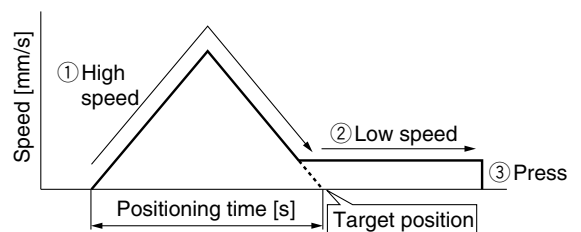
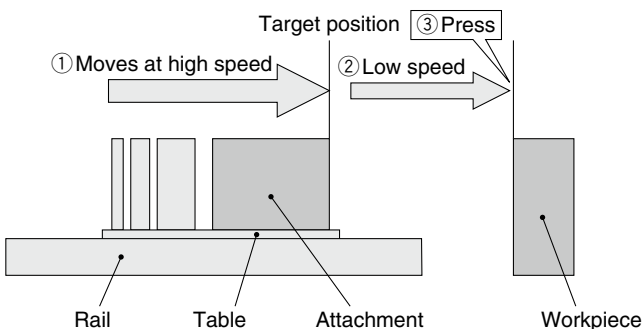

Movement profile for the Cycle Time Entry Method (Triangular)

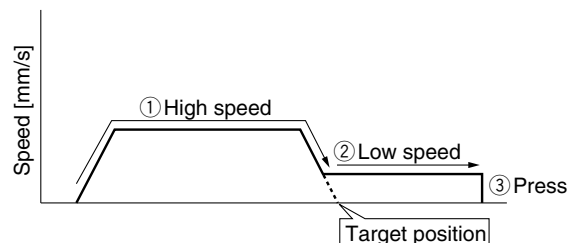

Movement profile for the Speed Entry Method (Trapezoidal)

⚠ Caution

For pushing operations, set the target position at least 1 mm away from the position where the table or the pushing tool comes into contact with the workpiece. Otherwise, the table may hit the workpiece at a speed exceeding the specified 6 mm/s pushing speed, which could damage the workpiece and Card Motor. The pushing force varies from the thrust setting value depending on the operating environment, pushing direction and table position. The thrust setting value is a nominal value. Calibrate the thrust setting value according to the application requirements.

Operation Modes

Length measurement, differentiation and quality judgement of workpieces are possible using the multi-counter (separately sold products: refer to page 974) and the AREA outputs of the controller.

Length Measurement

The amount of table movement is detected by the sensor (encoder) built into the Card Motor for measuring the size of workpieces.

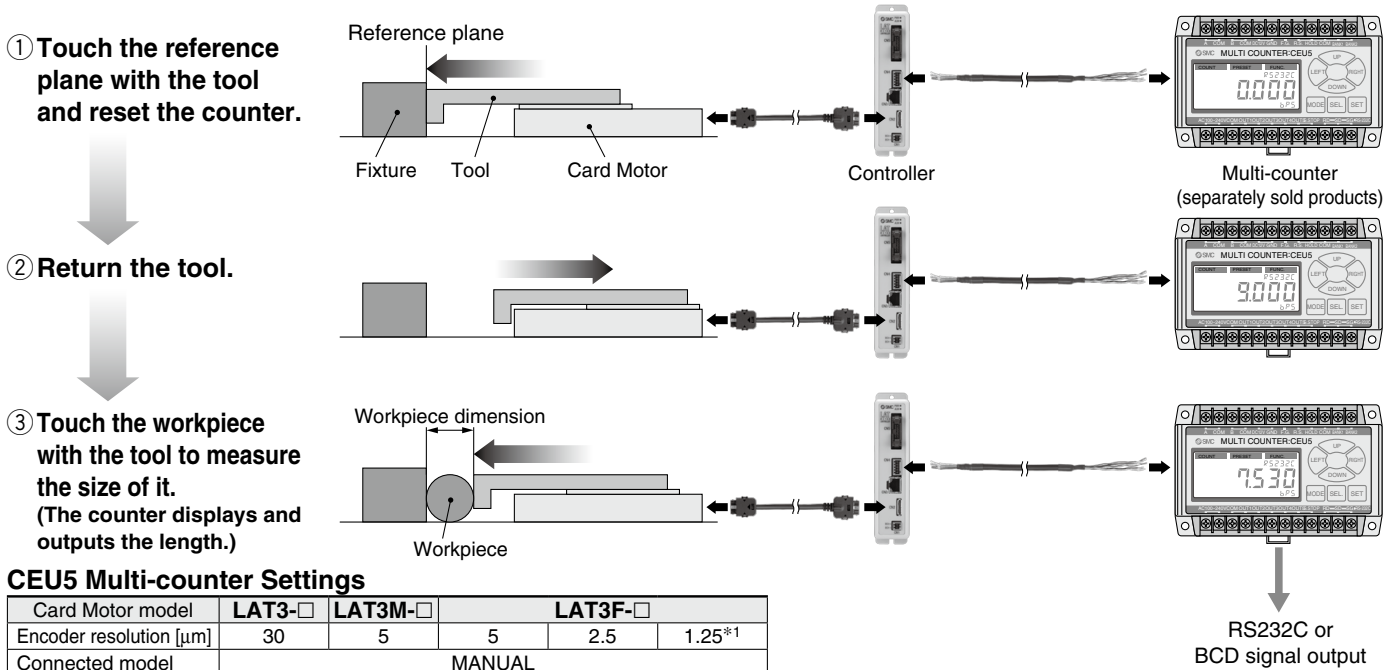

CEU5 Multi-counter Settings

Card Motor model	LAT3-□	LAT3M-□	LAT3F-□		
Encoder resolution [μm]	30	5	5	2.5	1.25*1
Connected model	MANUAL				
Multiplication factor	X4	X4	X1	X2	X4
Value per 1 pulse	00.0300	00.0050	00.0050	00.0025	0.00125
Decimal point position	**,****			*,*****	
Input signal	2PHASE				

*1 The decimal numbers will not be displayed when the resolution is set to "0.00125", because the CEU5 multi-counter has a 6-digit display.

Caution

The multi-counter may lose pulses when a long counter cable is used or the Card Motor is driven at high speed.

Workpiece Quality Judgement and Differentiation

The area output range preset in the controller is compared with the table position, and the AREA output signals are activated by the controller when the table is within the set range. These signals are used for quality judgement and differentiation of workpieces.

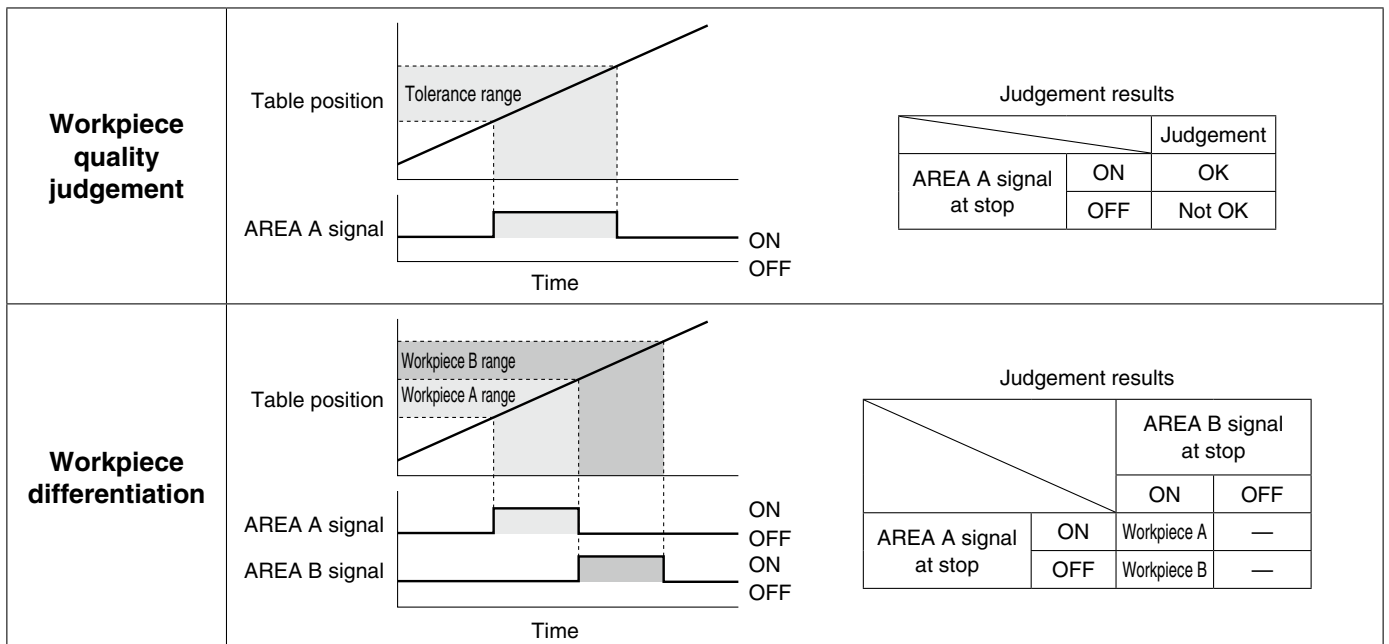

It is possible to output up to 31 preset points using the multi-counter (separately sold products: refer to page 974).

LEFS
LEFB
LEJS
LEJB
LEL
LEM
LEY
LEYG
LES
LESH
LEPY
LEPS
LER
LEH
LEY-X5
11-LEFS
11-LEJS
25A-
LEC
JXC
LECS
LECS-T
LECY
Motorless
LAT3

LATCA Series

Return to Origin

The Card Motor uses an incremental type sensor (linear encoder) to detect the position of the table. Therefore it is necessary to return the table to the origin position after the power has been turned on. There are three [Return to Origin] methods as stated below.

In any of the methods, the origin position (0) will be set at the connector side. When the table is moved away from the connector toward the opposite side, after the [Return to Origin] has been performed, the new position of the table is added in the controller (incremental positive direction).

- ① Retracted end position (Connector side)

The default origin position is set as the end on the connector side [Retracted End Position]. The table is moved to the connector side, returns toward the side opposite the connector side by 0.3 mm from the end, and stops. The stop position is set as 0 (the origin position).
- ② Extended end position

Fixture is used to stop the table of the card motor when [Return to Origin] is performed. The table is moved to the side opposite the connector side, returns toward the connector side by 0.3 mm from the end, and stops. The origin position (0) is set at an A mm stroke away from the stopping position toward the connector side.
- ③ Sensor origin

This method is used to achieve high positioning repeatability accuracy of the origin position. Only the LAT3M-□ and LAT3F-□, which feature an integrated sensor equipped with an origin position signal, can use this method. The table is moved to the connector side, and while returning toward the side opposite the connector side from the end it stops at the position where the sensor's origin position signal is detected. The origin position (0) is set at a certain distance (J) away from the stopping position toward the connector side.

If the table is returned to the origin position by the mechanical end stopper installed in the Card Motor, the origin position will be set to the position shown below.

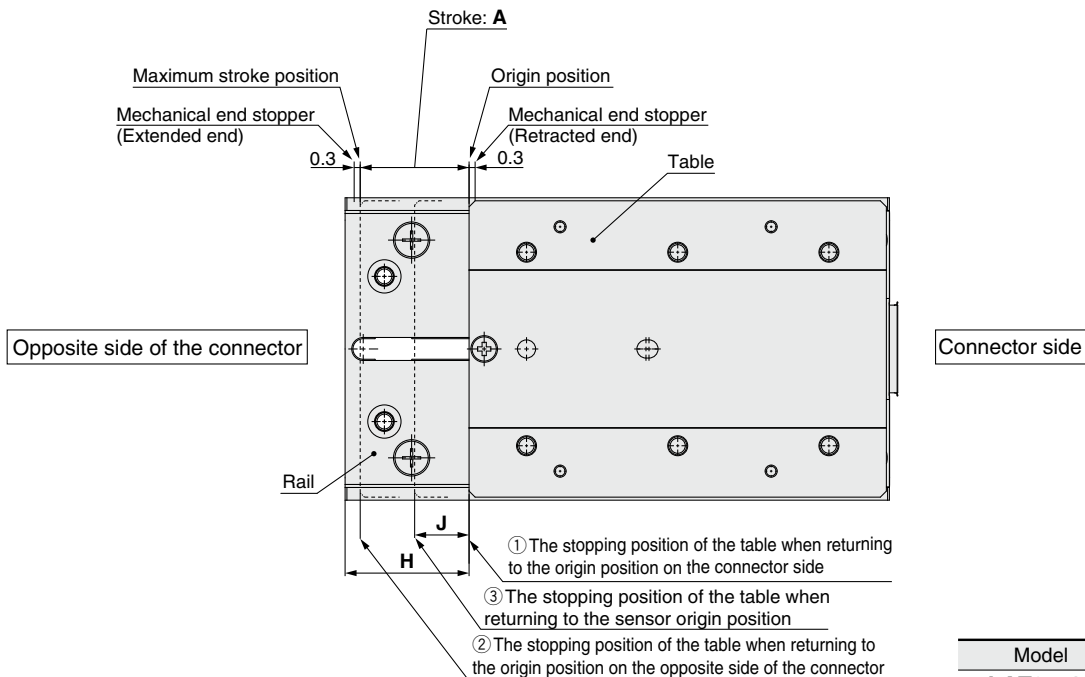

Model	A	H	J ^{*1}
LAT3□-10	10	10.5	5
LAT3□-20	20	20.5	5
LAT3□-30	30	30.5	15
LAT3□-50	50	70	25

*1 Only for the LAT3M-□ and LAT3F-□

⚠ Caution

- The origin position varies depending on the return to origin position method. Adjust according to the specific equipment used with this product.
- If the return to origin position is performed using fixture or workpiece to stop the table, the origin position may be set outside of the travel range. Do not set the target position of the step data outside of the Card Motor movable range. It may damage the workpieces and the Card Motor.

Setting Software

[Controller setting software]

LATC-Configurator

* Download from SMC's website:
<https://www.smcworld.com>

Compatible Controller/Driver

Step data input type/Pulse input type
 LATCA Series

Hardware Requirements

OS IBM PC/AT compatible machine running Windows® 8.1 (32-bit and 64-bit), Windows® 7 (32-bit and 64-bit), Windows® 10 (32-bit and 64-bit).

Communication interface USB 1.1 or USB 2.0 ports
Display XGA (1024 x 768)

* Windows® 7, Windows® 8.1 and Windows® 10 are registered trademarks of Microsoft Corporation.
 * Refer to the SMC website for version upgrade information: <https://www.smcworld.com>

Function

- Status display for parallel input signals and manual output of parallel output signals
- Entering of driven actuator
- Select input type (Step data input type/Pulse input type)
- Setting of the step data operating conditions
- Jog, constant speed and distance movements and test operation
- Monitoring of operation status (parallel input/output signals, position, speed and thrust)
- Alarm history display

Screen Example (Step data input type)

Basic Parameter Setup

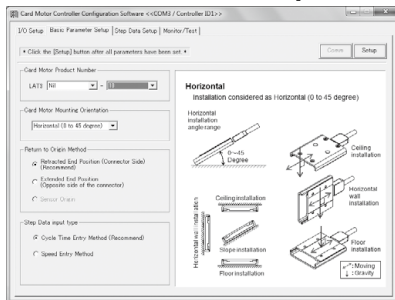

- Model selection of the Card Motor connected to controller
- Selection of return to origin method
- Selection of entry method (Cycle time entry method/Speed entry method)

Step Data Setup

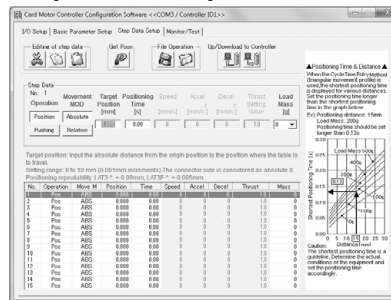

- Creation of 15 point step data
- Save/Open file of step data
- Setting step data to controller (Upload)
- Confirming step data set in controller (Download)
- Setting target position and positioning time (Cycle time entry method)
- Setting target position, speed, acceleration and deceleration (Speed entry method)

Monitor/Test

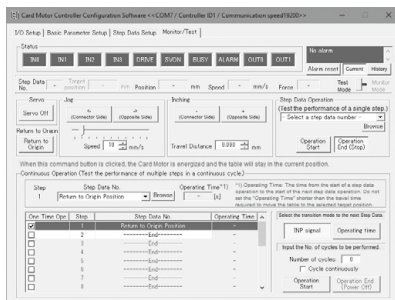

- Confirming set step data
- Can be used to jog and move at a constant rate.
- Operation confirmation of step data using PC
- Monitoring current position, current speed, and input/output status of parallel I/O
- Alarm history display

I/O Setup

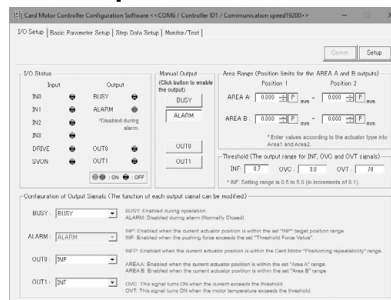

- Confirming input status of parallel I/O
- Manual output of parallel I/O
- Selection of output signal of parallel I/O

LEFS
LEJB
LEJ
LEM
LEY
LESH
LEPS
LER
LEH
LEY-X5
11-LEFS
11-LEJS
25A-
LEC
JXC
LECS
LECS-T
LECY
Motorless
LAT3

LATCA Series

Separately Sold Products

[Communication cable for controller setting]

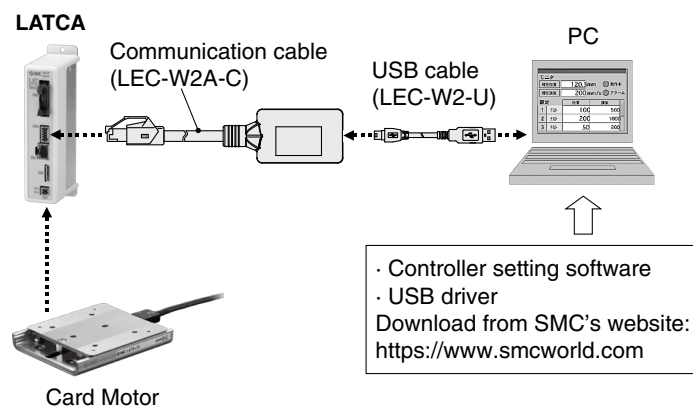

How to Order

LEC-W2A-C

Communication cable

LEC-W2-U

USB cable

Compatible Controller/Driver

Step data input type/Pulse input type **LATCA Series**

Hardware Requirements

OS	Windows® 7, Windows® 8.1, Windows® 10
Communication interface	USB 1.1 or USB 2.0 ports
Display	1024 x 768 or more

* Windows® 7, Windows® 8.1 and Windows® 10 are registered trademarks of Microsoft Corporation.

Separately Sold Products

[Actuator cable]

LATH1 - 1

Cable length (L)	
1	1 m
3	3 m
5	5 m

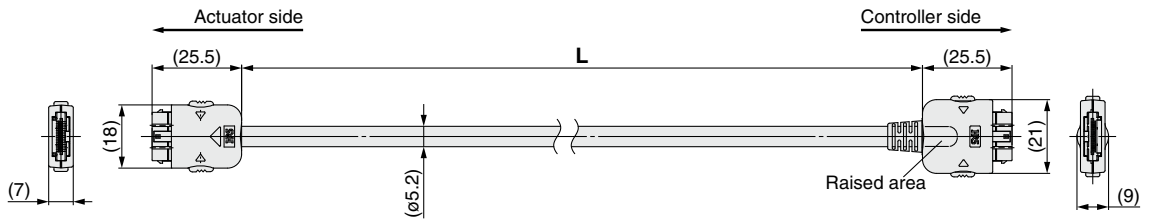

* The actuator cable is direction dependent. Make sure to connect the Card Motor side of the cable to the Card Motor and vice versa. There is a small raised area on the connector for the controller.

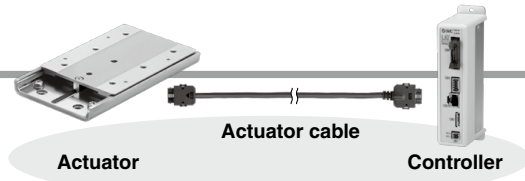

[I/O cable (without shield)]

LATH2 - 1

Cable length (L)	
1	1 m
3	3 m
5	5 m

* Conductor size: AWG28

This is used when inputting/outputting a general-purpose I/O signal.

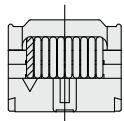
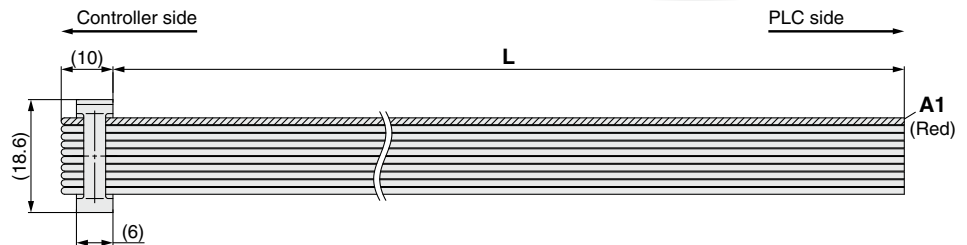

Polarized key

Color polarity indication (Red)

View C

Parallel I/O Plug Terminal List

Terminal no.	Function	Terminal no.	Function
A1	COM	B1	DC2(+)
A2	IN 0	B2	DC2(-)
A3	IN 1	B3	BUSY
A4	IN 2	B4	ALARM
A5	IN 3	B5	OUT 0
A6	DRIVE	B6	OUT 1
A7	SVON	B7	NC
A8	NC	B8	NC
A9	NC	B9	NC
A10	NC	B10	NC

[I/O cable (with shield)]

LATH5 - 1

Cable length (L)	
1	1 m
3	3 m
5	5 m

* Conductor size: AWG28

The cable is shielded. This is used when inputting a pulse input signal.

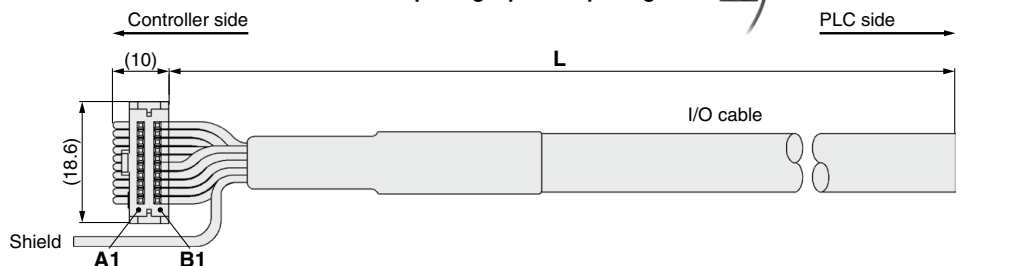

Parallel I/O Plug Terminal List (Pulse input type)

Terminal no.	Function	Insulation color	Dot mark	Dot color	Terminal no.	Function	Insulation color	Dot mark	Dot color
A1	COM	Light brown	■	Red	B1	DC2(+)	Light brown	■ ■	Red
A2	IN0	Yellow	■	Black	B2	DC2(-)	Light brown	■ ■	Black
A3	IN1	Yellow	■	Red	B3	BUSY	Yellow	■ ■	Red
A4	SETUP	Light green	■	Black	B4	ALARM	Yellow	■ ■	Black
A5	CLR	Light green	■	Red	B5	OUT0	Light green	■ ■	Red
A6	TL	Gray	■	Black	B6	OUT1	Light green	■ ■	Black
A7	SVON	Gray	■	Red	B7*1	PP+	Gray	■ ■	Red
A8	NC	White	■	Black	B8*1	PP-	Gray	■ ■	Black
A9	NC	White	■	Red	B9*1	NP+	White	■ ■	Red
A10	NC	White	■	Black	B10*1	NP-	White	■ ■	Black

*1 When using the controller for the step data input type, do not wire output terminals B7 to B10. It can cause a failure as there is an internal circuit used as a pulse signal input terminal.

* When a step data input type is selected for input type of the controller, the function of each terminal differs from the list on the left. Refer to the LATH2 when using the controller for the step data input type.

- LEFS
- LEFB
- LEJS
- LEJB
- LEL
- LEM
- LEY
- LEYG
- LES
- LESH
- LEPY
- LEPS
- LER
- LEH
- LEY-X5
- 11-LEFS
- 11-LEJS
- 25A-
- LEC
- JXC
- LECS
- LECS-T
- LECY
- Motorless
- LAT3

LATCA Series

Separately Sold Products

[Counter cable]

LATH3-1

Cable length (L)

1	1 m
3	3 m
5	5 m

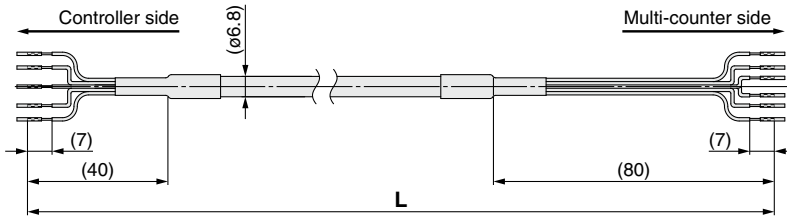

Wiring Diagram

Terminal no.	Circuit	Cable color
1	PhaseB	White
2	PhaseA	Red
3	GND	Light gray
4	RESET	Yellow
5	FG	Green

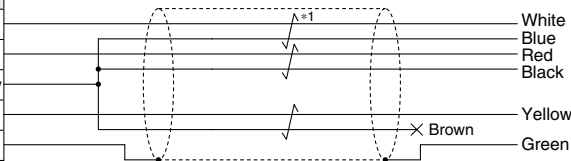

*1 indicates a twisted pair cable.

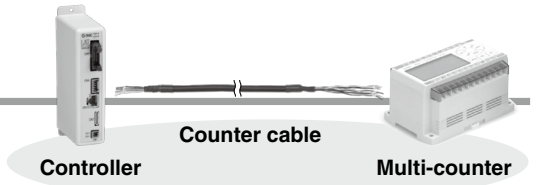

[Communication cable]

LATH6-1

Cable length (L)

1	1 m
---	-----

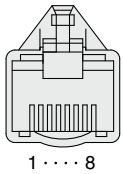

Communication Plug Terminal List

Terminal no.	Function	Insulation color
1	NC	—
2	NC	—
3	SD+	White
4	SD-	Black
5	NC	—
6	NC	—
7	NC	—
8	NC	—
Connector case	FG	Shield

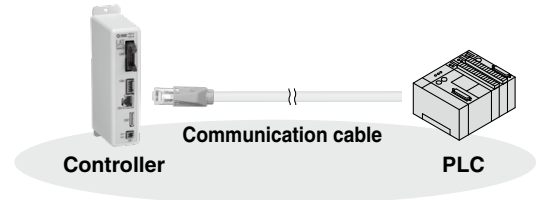

[Branch communication cable]

LATH7-1

Cable length (L)

1	1 m
---	-----

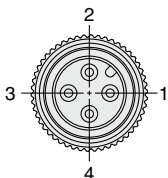

Branch Communication Plug Terminal List

Terminal no.	Function	Insulation color
1	NC	—
2	SD+	White
3	FG	Shield
4	SD-	Black

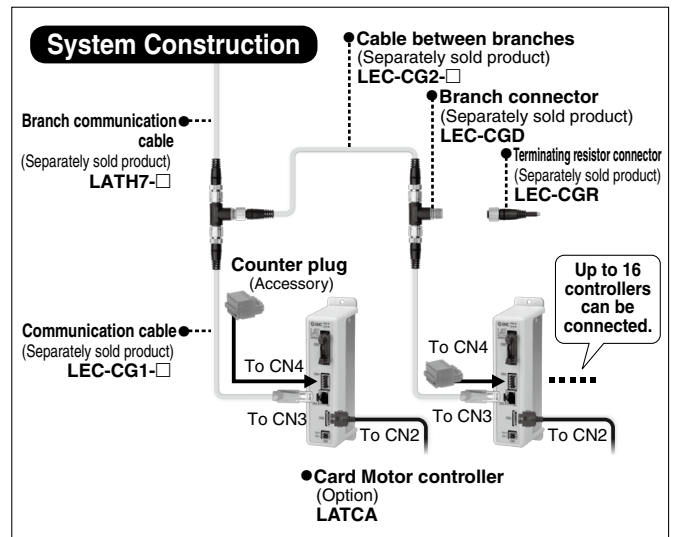

[Cable]

LEC-CG 1-L

Cable type

1	Communication cable
2	Cable between branches

Cable length

K	0.3 m
L	0.5 m
1	1 m



Communication cable



Cable between branches

[Branch connector]

LEC-CGD

Branch connector



[Terminating resistor]

LEC-CGR



Separately Sold Products

[Multi-counter]

This counter displays the table position of the Card Motor and performs preset outputs according to the program (preset data and output form, etc.) when measuring. The RS-232C can be used to send the table position to a PLC or PC or to set the Multi-counter.

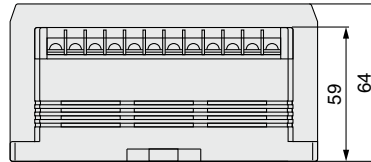
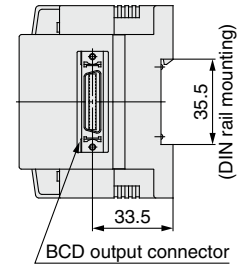
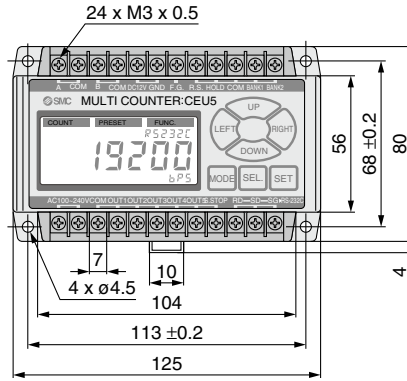
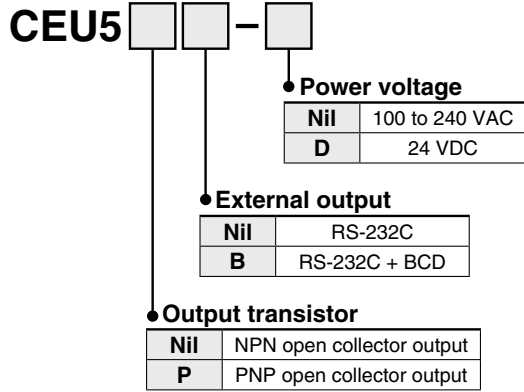

Specifications

Model	CEU5□□-□□
Mounting method	Surface mounting (Fixed by DIN rail or screw)
Operation mode	Operating mode, Data setting mode, Function setting mode
Display	LCD with backlight
Number of digits	6 digits
Counting speed	100 kHz
Insulation resistance	Between case and AC line: 500 VDC, 50 MΩ or more
Ambient temperature	0 to +50°C (No freezing)
Ambient humidity	35 to 85% RH (No condensation)
Weight	350 g or less

* Refer to the **Web Catalog** and the Operation Manual for details.

■ Wiring Example

Multi-counter CEU5 Terminal Block

Name	Cable color
A	Red
COM	Black
B	White
COM	Blue
12 VDC	-
GND	-
F.G.	Green
RESET	Yellow
HOLD	-
COM	-
BANK1	-
BANK2	-

Controller LATCA Counter Plug

Cable color	Name
White	PhaseB
Red	PhaseA
Light gray	GND
Yellow	RESET
Green	F.G.

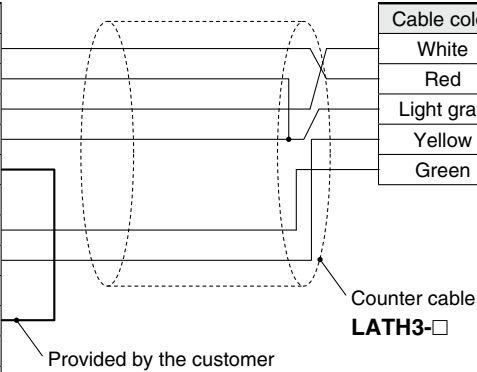

- LEFS
- LEFB
- LEJS
- LEJB
- LEL
- LEM
- LEY
- LEYG
- LES
- LESH
- LEPY
- LEPS
- LER
- LEH
- LEY-X5
- 11-LEFS
- 11-LEJS
- 25A-
- LEC□
- JXC□
- LECS□
- LECS□-T
- LECY□
- Motorless
- LAT3



LAT3 Series

Specific Product Precautions 1

Be sure to read this before handling the products. Refer to page 984 for safety instructions, pages 985 to 990 for electric actuator precautions.

Design / Selection

Warning

1. Consider possible movements of the actuator in the event of an emergency stop, alarm or power failure.

If power is not supplied to the product due to an emergency stop or if the SVON signal is turned OFF, in the event of an alarm (when temperature of the Card Motor exceeds 70°C) or at power failure, the table will not be held in place and may be moved by external forces. Design the Card Motor application so that people and equipment will not be injured or damaged by the table movement.

2. Effects on implantable medical devices

This product uses a rare earth magnet. Therefore, it may cause interference with implantable medical devices such as cardiac pacemakers and cardioverter defibrillators, resulting in the malfunction of the medical device or other adverse effects. Please use extreme caution when operating equipment which may have an adverse effect on your implantable medical device. Be sure to thoroughly read the precautions stated in the catalog, operation manual, etc., of your implantable medical device or contact the manufacturer directly for further details on what types of equipment need to be avoided.

Caution

1. Do not apply a load outside the specifications.

The Card Motor should be fitted for the application based on the maximum work load and allowable moments. If the product is used outside the specifications, the excess load applied to the guide will lead to play in the guide, decrease in accuracy and the life span of the product will be shortened.

2. Do not use the product in applications where excessive external force or impact is applied to it.

Otherwise, a failure or malfunction can result.

3. The Card Motor is equipped with a stopper to prevent the table from coming off and to be resistant to light impacts generated by returning to origin or during transportation.

Thus, excessive external force or impact may damage the product, so please install a separate external stopper if the operating conditions require.

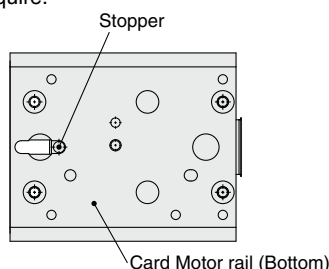

4. Strong magnet

The Card Motor contains a strong rare earth magnet, whose magnetic field may affect the workpiece. Mount the workpiece away from the Card Motor far enough to prevent the magnetic field from affecting the workpiece.

5. In pushing operation, use thrust setting values within the allowable limits.

Otherwise, it may cause overheating of the workpiece or the mounting surface.

6. The flatness of the mounting surface of the table and rail must be 0.02 mm or less.

Unevenness of a workpiece the Card Motor is mounted to or of the base the Card Motor is mounted onto, can cause play in the guide and an increase in the sliding resistance.

Design / Selection

Caution

7. SMC products are not intended for use as instruments for legal metrology.

Measurement instruments that SMC manufactures or sells have not been qualified by type approval tests relevant to the metrology (measurement) laws of each country. Therefore, SMC products cannot be used for business or certification ordained by the metrology (measurement) laws of each country.

8. Prevent workpieces mounted on the body from vibrating.

Vibration may be caused during the positioning operation.

Handling

Warning

1. Do not touch the product when it is energized or for a few minutes after it has been de-energized.

The surface temperature of the Card Motor can increase up to approximately 70°C depending on the operating conditions. Energizing alone may also cause the temperature to increase. Do not touch the Card Motor during operation or when energized to prevent burns or other injuries.

Caution

1. Strong magnet

The Card Motor contains a strong rare earth magnet. If a magnetic card is brought close to the Card Motor, the card data may get distorted or lost. Do not bring items, which are sensitive to or affected by magnetism close to the product.

2. Do not operate the Card Motor continuously with an allowable set thrust or more at 100% of duty ratio.

The Card Motor may overheat due to the heat generated by the Card Motor itself, and a temperature error or malfunction may occur.

3. Do not hit the stroke ends during operation, except during return to origin and in pushing operation.

Otherwise, a failure can result.

4. For pushing operations, set the target position at least 1 mm away from the position where the pushing tool comes into contact with the workpiece.

Otherwise, the table may hit the workpiece at a speed exceeding the specified pushing speed.

5. The table and the guide rail are made of special stainless steel, but can rust in an environment where droplets of water adhere to it.

6. Do not dent, scratch or cause other damage to the steel ball rolling surface of the table and the rail.

Otherwise, it will result in play or increased sliding friction.

7. Positioning accuracy, thrust and measurement accuracy may vary after the Card Motor or the work load have been mounted, depending on the mounting conditions and environment.

Calibrate them according to the actual application.

8. Consider mounting a bumper on the pushing surface.

If impact to the Card Motor should be avoided during pushing operation, we recommend an elastic bumper is attached on the pushing surface.



LAT3 Series

Specific Product Precautions 2

Be sure to read this before handling the products. Refer to page 984 for safety instructions, pages 985 to 990 for electric actuator precautions.

Installation

⚠ Caution

1. Strong magnet

The Card Motor contains a strong rare earth magnet. If magnetized workpieces, tools and metallic parts are brought in the vicinity of the Card Motor, they will be attracted, which could cause injury to operators and damage equipment. Take special care when handling and operating the product.

2. Mount the Card Motor on a base with good cooling performance, for example a metal plate.

If the cooling performance is not good enough, the temperature of the Card Motor will increase and a failure can result.

3. If magnetized parts are mounted on the Card Motor, thrust changes, which may lead to vibration.

Please contact SMC when magnetized parts are mounted on the Card Motor.

4. Do not apply strong impact or an excessive moment to the Card Motor while mounting a workpiece.

If an external force over the allowable moment is applied, it may cause play in the guide or an increase in the sliding resistance.

5. Do not dent, scratch or cause other damage to the table and rail mounting surfaces.

This may cause unevenness in the mounting surface, play in the guide or an increase in the sliding resistance.

6. When mounting the Card Motor, use stainless steel screws with appropriate length and tighten with recommended tightening torque.

If the maximum screw-in depth is exceeded, it may damage the internal components. Using a tightening torque higher than the specified torque may cause a malfunction, and using a lower tightening torque may displace the workpiece or cause it to drop off.

1) Body mounting/Body tapped

Screw size (Stainless steel)	M3 x 0.5
Max. recommended torque [N·m]	0.63
L1 (Max. screw-in depth) [mm]	4.6
L2 (Plate thickness) [mm]	2.1

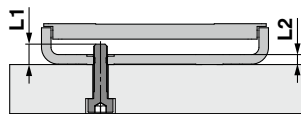

2) Body mounting/Through hole

Screw size (Stainless steel)	M2.5 x 0.45
Max. recommended torque [N·m]	0.36
L3 (Max. screw-in depth) [mm]	2.5
L4 (Plate thickness) [mm]	2.1

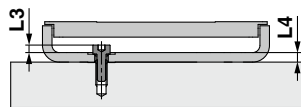

3) Workpiece mounting/Top mounting

Screw size (Stainless steel)	M3 x 0.5
Max. recommended torque [N·m]	0.63
L5 (Max. screw-in depth) [mm]	2.5

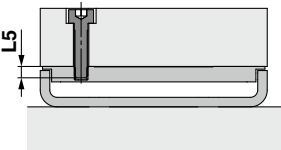

7. When connecting the cables, avoid applying any stress to the connector from the cable side.

If an external force or vibration is applied to the connector, a failure can result. Do not bend the cable for approximately 20 mm from the connector and fix this part of the cable with a cable fixture.

Grounding

⚠ Warning

1. Always ground the Card Motor.

2. Use a dedicated grounding.

Use a D-class grounding. (Ground resistance 100 Ω or less)

3. The grounding point should be as close as possible to the actuator, and the ground wires as short as possible.

Operating Environment

⚠ Caution

1. Do not use the products in an area where they could be exposed to dust, metallic powder, machining chips or splashes of water, oil or chemicals.

Otherwise, a failure or malfunction can result.

2. Do not use the products in a magnetic field.

Otherwise, the ambient magnetic field may affect the motor and a malfunction or failure can result.

3. Do not expose the product to a strong light sources, such as direct sunlight.

The Card Motor uses an optical sensor to detect the position, so if it is exposed to a strong light source such as direct sunlight, a malfunction could result. In such a case, install a light shielding plate such as a cover to shield the sensor from light.

4. Do not use the products in an environment where flammable, explosive or corrosive gases, liquids or other substances are present.

Otherwise, fire, explosion or corrosion can result.

5. Avoid heat radiation from strong heat sources, such as direct sunlight or a hot furnace.

Otherwise, the product can overheat and a failure can result.

6. Do not use the products in an environment with cyclic temperature changes.

Otherwise, a failure can result.

7. Use the products within the operating temperature and humidity range.

Maintenance

⚠ Caution

1. Perform regular maintenance and inspections.

Confirm that there is no twisting of wires, play in the table or large sliding friction. This may result in a malfunction.

2. Conduct an appropriate functional inspection and test after completed maintenance.

In case of any abnormalities (if the actuator does not move or the equipment does not operate properly, etc.), stop the operation of the system. Otherwise, unexpected malfunction may occur and safety cannot be assured. Conduct a test of the emergency stop to confirm the safety of the equipment.

3. Do not disassemble, modify or repair the product.

4. Maintenance space

Allow sufficient space for maintenance and inspection.

5. Be sure to refrain from using air blow as it may result in grease spatter from the internal parts of the Card Motor or the dropping, failure, or malfunction of parts.

LEFS
LEFB

LEJS
LEJB

LEL

LEM

LEY
LEYG

LES
LESH

LEPY
LEPS

LER

LEH

LEY-X5

11-LEFS

11-LEJS

25A-

LEC

JXC

LECS
LECS-T

LECY

Motorless

LAT3



LAT3 Series Controller and Peripheral Devices Specific Product Precautions 1

Be sure to read this before handling the products. Refer to page 984 for safety instructions, pages 985 to 990 for electric actuator precautions.

Design / Selection

Warning

- 1. Use the specified voltage.**
If the applied voltage is higher than the specified voltage, malfunction and damage to the controller may result. If the applied voltage is lower than the specified voltage, there is a possibility that the load cannot be moved due to internal voltage drop. Check the operating voltage prior to start. Also, confirm that the operating voltage does not drop below the specified voltage during operation. If the current is too low, the Card Motor may not be able to generate the maximum force or cause a malfunction.
- 2. Do not use the products outside the specifications.**
Otherwise, fire, malfunction or damage to the product can result. Check the specifications prior to use.
- 3. Install an emergency stop circuit.**
Install an emergency stop outside the enclosure in easy reach to the operator so that the operator can stop the system operation immediately and intercept the power supply.
- 4. To prevent danger and damage due to a breakdown or malfunction of these products, which may occur at a certain probability, a backup system should be arranged in advance by using a multiple-layered structure or by making a fail-safe equipment design, etc.**
- 5. If there is a risk of fire or personal injury due to abnormal heat generation, sparking, smoke generated by the product, etc., cut off the power supply from this product and the system immediately.**

Handling

Warning

- 1. Never touch the inside of the controller and its peripheral devices.**
Otherwise, electric shock or failure can result.
- 2. Do not operate or set up this equipment with wet hands.**
Otherwise, electric shock can result.
- 3. Do not use a product that is damaged or missing any components.**
Electric shock, fire or injury can result.
- 4. Do not connect the controller to other devices than the Card Motor.**
Otherwise, it may cause damage to the controller or to the other equipment.
- 5. Be careful not to touch, get caught or hit by the workpiece while the Card Motor is moving.**
An injury can result.
- 6. Do not connect the power supply or power up the product until it is confirmed that the workpiece can be moved safely within the area that can be reached by the workpiece.**
Otherwise, the movement of the workpiece may cause an accident.
- 7. Do not touch the product when it is energized and for some time after the power has been disconnected, as it is very hot.**
Otherwise, it may cause burns due to the high temperature.
- 8. Check the voltage using a tester at least 5 minutes after power-off when performing installation, wiring and maintenance.**
Otherwise, electric shock, fire or injury can result.
- 9. Static electricity may cause a malfunction or damage the controller. Do not touch the controller while power is supplied to it.**
Take sufficient safety measures to eliminate static electricity when it is necessary to touch the controller for maintenance.

Handling

Caution

- 1. When the Multi-counter is not used, attach the counter plug to the counter connector of the controller.**
If foreign matter such as metal fragments enters the counter connector, short-circuit may occur.
- 2. Be sure to perform return to origin prior to start.**
If the origin position is not set, the product will not operate even if the step data is performed.
- 3. The positioning time entered and set in the controller setting software is just a target value. It cannot be guaranteed.**
The operation may not have been completed even if the set positioning time has passed. In such a case, the BUSY and INP digital output signals can be used to detect when the operation has been completed.
- 4. Set the "Load Mass" value in the controller setting software according to the approximate weight of attachment or workpieces mounted on the Card Motor.**
If the "Load Mass" value in the controller setting software and the weight of the work load are different, the product may vibrate or the positioning accuracy may be reduced.
- 5. The Card Motor has stopped at a target position, depending on the operating conditions the Card Motor may continuously hunt for the target position (vibrate) within the positioning accuracy range.**
Please contact an SMC sales representative for how to improve it.
- 6. BUSY signal**
The BUSY signal turns ON when the Card Motor begins to operate, and it turns OFF when the operating speed reaches 2 mm/s or less. However, when the Card Motor operates at a slower speed than 5 mm/s, the BUSY signal may not turn ON at all.
- 7. INP output signal (OUT0)**
Both for positioning operations and pushing operations, the INP signal will turn ON when the table has reached within the INP output range of the target position.
For pushing operations, if the table exceeds the target position and moves outside the INP output range, the INP signal will turn OFF again.

Output range of the INP signal (OUT0)

Model	Output range [mm]
LAT3F-□	±0.05
LAT3M-□	±0.1
LAT3-□	±0.3

Mounting

Warning

- 1. Install the controller and its peripheral devices on fireproof material.**
Direct installation on or near flammable material may cause fire.
- 2. Do not install these products in a place subject to vibration and impact.**
Otherwise, a malfunction or failure can result.
- 3. Do not mount the controller and its peripheral devices on the same base together with a large-sized electromagnetic contactor or no-fuse breaker that generate vibration. Mount them on different base plates, or keep the controller and its peripheral devices away from such vibration supplies.**
Otherwise, a malfunction can result.
- 4. Install the controller and its peripheral devices on a flat surface.**
If the mounting surface is not flat or uneven, excessive force may be applied to the housing and other parts resulting in a malfunction.

Power Supply

Warning

- 1. Use a power supply with low noise between lines and between power and ground.**
In cases where noise is high, use an isolation transformer.
- 2. The power supplies should be separated between the controller power and the I/O signal power, and both power supplies must not be of "inrush current limited" type.**
If the power supply is of "inrush current limited" type, a voltage drop may occur during the acceleration or deceleration of the actuator.



LAT3 Series Controller and Peripheral Devices Specific Product Precautions 2

Be sure to read this before handling the products. Refer to page 984 for safety instructions, pages 985 to 990 for electric actuator precautions.

Power Supply

Warning

- Take appropriate measures to prevent surges from lightning. Ground the surge absorber for lightning separately from the grounding of the controller and its peripheral devices.
- Use the UL-certified products listed below as direct current power supplies.

- (1) Limited voltage current circuit in accordance with UL 508.
A circuit in which power is supplied by secondary coil of an insulated transformer that meets the following conditions
- Maximum voltage (No load): 30 Vrms (42.4 V peak) or less
 - Maximum current : ① 8 A or less (including short circuit)
② Limited by a circuit protector (such as a fuse) with the following ratings

Voltage without load (V peak)	Maximum current rating
0 to 20 [V]	5.0
Over 20 [V] up to 30 [V]	100
	Peak voltage

- (2) Circuit (of class 2) which is of maximum 30 Vrms (42.4 V peak) or less, with UL 1310 class 2 power supply unit or UL 1585 class 2 transformer.

Grounding

Warning

- Make sure the product is grounded to ensure the noise tolerance of the controller.
Otherwise, it may cause a malfunction, damage, electric shock or fire. Do not share the earth with devices or equipment that generates a strong electromagnetic noise.
- Use a dedicated grounding.
Use a D-class grounding. (Ground resistance 100 Ω or less)
- The grounding point should be as close as possible to the controller, and the ground wires as short as possible.
- In the unlikely event that malfunction is caused by the ground, it may be disconnected.

Wiring

Warning

- Preparation for wiring
Turn the power supply off before wiring or plugging and unplugging of connectors. Mount a protective cover on the terminal block after the wires have been connected.
- Do not route the digital I/O signal and power cables together.
Malfunctions stemming from noise may occur if the signal line and output lines are routed together.
- Confirm proper wiring before turning the power on.
Incorrect wiring will lead to malfunction or may damage the controller or its peripheral devices. Confirm that there is no mis-wiring before turning the power on.
- Reserve enough space for the routing of the cables
If the cables are forced into unreasonable positions, it may damage the cables and connectors, which may lead to misconnection and result in a malfunction. Avoid bending the cables in sharp angles close to the connectors or where they enter the product. Fix the cable as close as possible to the connectors so that mechanical stress cannot be applied to the connectors.

Operating Environment

Caution

- Do not use the products in an area where they could be exposed to dust, metallic powder, machining chips or splashes of water, oil or chemicals.
Otherwise, a failure or malfunction can result.
- Do not use the products in a magnetic field.
Otherwise, a malfunction or failure can result.
- Do not use the products in an environment where flammable, explosive or corrosive gases, liquids or other substances are present.
Otherwise, fire, explosion or corrosion can result.
- Avoid heat radiation from strong heat sources, such as direct sunlight or a hot furnace.
Otherwise, it will cause a failure to the controller or its peripheral devices.
- Do not use the products in an environment with cyclic temperature changes.
Otherwise, it will cause a failure to the controller or its peripheral devices.
- Do not use the products in an environment where surges are generated.
Devices (solenoid type lifters, high frequency induction furnaces, motors, etc.) that generate a large amount of surge around the product may lead to deterioration or damage to the internal circuits of the products. Avoid supplies of surge generation and crossed lines.
- The Card Motor and the controller are not immune to lightning strikes.
- Do not install these products in a place subject to vibration and impact.
Otherwise, a malfunction or failure can result.

Maintenance

Warning

- Perform maintenance checks periodically.
Confirm wiring and screws are not loose. Loose screws or wires may cause unexpected malfunction.
- Conduct an appropriate functional inspection and test after completed maintenance.
In case of any abnormalities (if the actuator does not move or the equipment does not operate properly, etc.), stop the operation of the system. Otherwise, unexpected malfunction may occur and safety cannot be assured. Conduct a test of the emergency stop to confirm the safety of the equipment.
- Do not disassemble, modify or repair the controller or its peripheral devices.
- Do not put anything conductive or flammable inside the controller.
Otherwise, fire can result.
- Do not conduct an insulation resistance test or insulation withstand voltage test.

Caution

- Reserve sufficient space for maintenance.
Design the system so that it allows required space for maintenance.

LEFS
LEFBLEJS
LEJB

LEL

LEM

LEY
LEYGLES
LESHLEPY
LEPS

LER

LEH

LEY-X5

11-LEFS

11-LEJS

25A-

LEC

JXC

LECS
LECS-T

LECY

Motorless

LAT3