

# Vacuum Flow

New

RoHS

**Blow** Max. **6820** L/min (ANR)\*4 and **Vacuum** Max. **5270** L/min (ANR)\*4 can be performed by supplying compressed air.

It is possible to adjust the blow and vacuum flow rate by adjusting the nozzle position!

Air supply

Hexagon socket set screw\*1

Turning the nozzle counterclockwise **increases** the flow rate (vacuum pressure increases).

Turning the nozzle clockwise **decreases** the flow rate (vacuum pressure decreases).

Suction flow rate can be increased by **3 times** or more.

Discharge flow rate can be increased by **4 times** or more.

A blow flow rate **4 times** or more the supply air

Contributes to reduction in flow consumption if discharge requires flow rate.

\* Excludes the ZHV10

Nozzle

A vacuum flow rate **3 times** or more the supply air

Contributes to reduction in flow consumption if suction requires flow rate.

\* Excludes the ZHV10

\*1 Loosen the hexagon socket head set screw before adjusting the nozzle and re-tighten the screw after adjustment has been made.

\* The suction flow rate, discharge flow rate, and air consumption will change.

**Weight** Max. **50% reduction**\*2 (208 g reduction)  
**209 g ← 417 g**

**Volume** Max. **50% reduction**\*3 (17000 mm<sup>3</sup> reduction)  
**17000 mm<sup>3</sup> ← 34000 mm<sup>3</sup>**

\*2 ZHV20, in comparison with product (ZH20-X185) \*3 ZHV10, in comparison with product (ZH10-X185)  
\*4 Values for the ZHV40 when the supply pressure is 0.5 MPa

In terms of body mounting, port connection, and passage diameter, this product is compatible with the product (ZH-X185).

## Series Variations

Series	Vacuum pressure [kPa]	Suction flow rate	Discharge flow rate	Air consumption	Fluid passage dia.
ZHV10	-6	520	670	180	ø13
ZHV20		1975	2360	380	ø21.6
ZHV30		4590	5310	710	ø30
ZHV40		5270	6820	1330	ø42

\* Although the performance of these products is the same as that of the corresponding ZH□-X185 product, various values may be different depending on the measurement method.

At 0.5 MPa supply pressure  
Settings at the time of shipment from the factory (Representative values)

**ZHV Series**



CAT.ES100-152A

## Large passage diameter available for suction of machining chips, particles, etc.

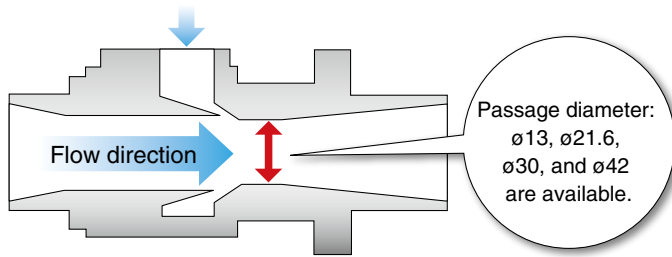

## Maintenance free

No regular motor maintenance is necessary compared with an electric blower.

## Mounting bracket and dust bag are available.

With bracket

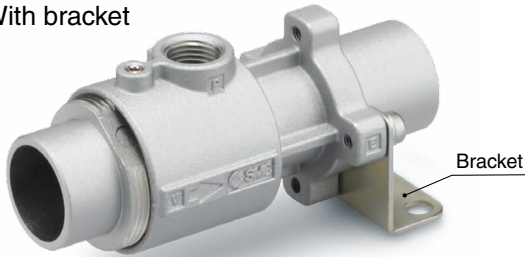

With dust bag  
Passage diameter: 10  $\mu\text{m}$



## Application Examples

### Blow

Blowing away water droplets

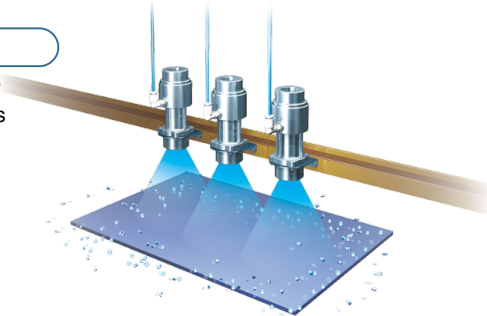

Blowing away machining chips

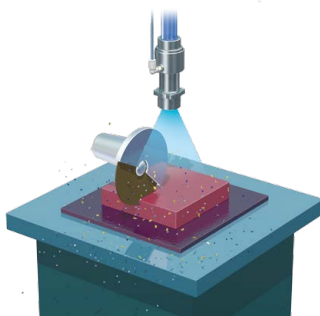

### Vacuum

Resin part marking system powder collection

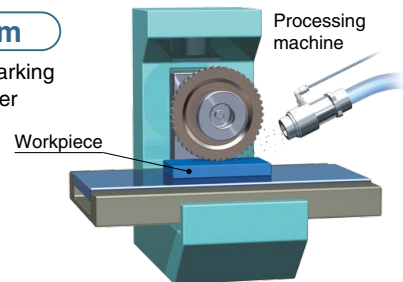

Transferring

\* Transferring materials such as pellets

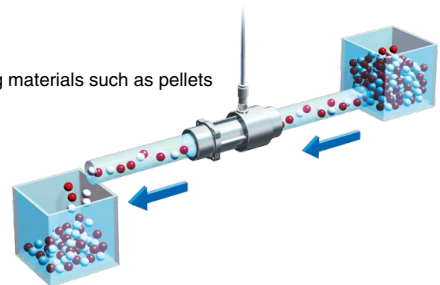

\* SMC does not guarantee the entire system. Please think the system shown above as an example.  
A workpiece that is harder than the body material may damage to the inside of the body, causing the performance to lower.  
The compatibility should be judged by the customer before adopting the product.

## Other Vacuum Flow

Series	Vacuum pressure [kPa]	Application examples	More information can be viewed here.
ZH-X226	-40	<ul style="list-style-type: none"> <li>For adsorption transfer</li> <li>For the adsorption transfer of workpieces with leakage</li> </ul>	
ZH-X338	-40	<ul style="list-style-type: none"> <li>For coolant blow to blow off cutting chips</li> <li>Increased coolant blow pressure due to compressed air</li> </ul>	
ZH10-B-X249	-22	<ul style="list-style-type: none"> <li>For water droplet removal</li> </ul>	
ZH-X341	-6	<ul style="list-style-type: none"> <li>Collection of solid hard workpieces</li> <li>Body material: Stainless steel</li> </ul>	

# Vacuum Flow ZHV Series

RoHS

## How to Order

ZHV **20** - **□** **B**

①      ②      ③



### ① Passage diameter

Symbol	mm
10	ø13
20	ø21.6
30	ø30
40	ø42

### ② SUP. port thread type

Nil	Rc
F	G
N	NPT

### ③ Accessory

Nil	None
B	With bracket
D	With dust bag
BD	With bracket/dust bag

\* Accessory is shipped together with the product.  
The dust bag comes with a hose band.

## ⚠ Warning

1. Because suctioned matter is ejected together with the exhaust, do not direct an exhaust port at a person or other equipment.
2. Do not use in an atmosphere which contains corrosive gases, chemicals, organic solvents, sea water, water steam, or where there is direct contact with any of these.

## Specifications

Model	ZHV10	ZHV20	ZHV30	ZHV40
Body material	Aluminum die-cast			
Seal material	NBR			
Bracket material	Steel			
Hose band material	Stainless steel			
Dust bag material	Polyester			
Dust bag filtration [ $\mu\text{m}$ ]	10			
Passage diameter	ø13	ø21.6	ø30	ø42
C [ $\text{dm}^3/(\text{S}\cdot\text{bar})$ ] (Effective area [ $\text{mm}^2$ ])* <sup>1</sup>	0.49 (2.46)	1.04 (5.19)	1.97 (9.86)	3.69 (18.47)
Fluid	Air			
Supply pressure range	0 to 0.7 MPa			
Ambient and fluid temperatures [ $^{\circ}\text{C}$ ]	-5 to 80 (No freezing or condensation)			
Weight [ $\text{g}$ ]* <sup>2</sup>	46 (55)	209 (228)	526 (587)	1063 (1182)
Bracket assembly	ZH-BK1-10-A	ZH-BK1-20-A	ZH-BK1-30-A	ZH-BK1-40-A
Dust bag assembly	ZH-DB1-10-A	ZH-DB1-20-A	ZH-DB1-30-A	ZH-DB1-40-A

\*<sup>1</sup> The C value and effective area are theoretical values based on the assumption that the nozzle position is unchanged since shipment.

\*<sup>2</sup> ( ): Weight including the bracket

## Construction

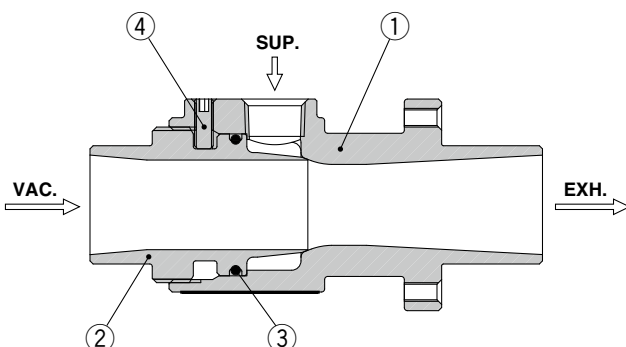

No.	Description	Material	Note
1	Body	Aluminum die-cast	Silver
2	Nozzle	Aluminum die-cast	Silver
3	O-ring	NBR	Grease applied
4	Hexagon socket set screw	Steel	

## Exhaust Characteristics (Representative values)

### ZHV10

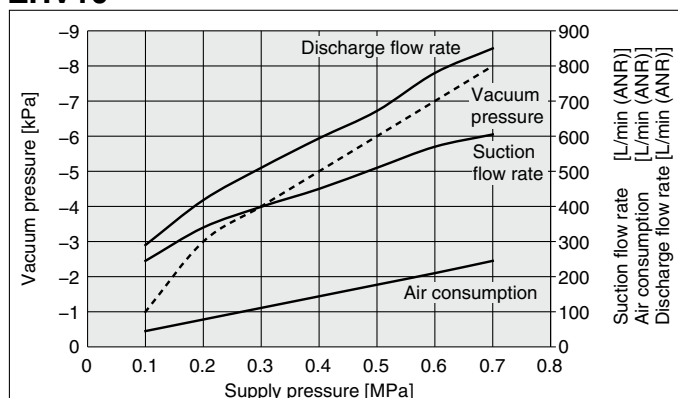

### ZHV20

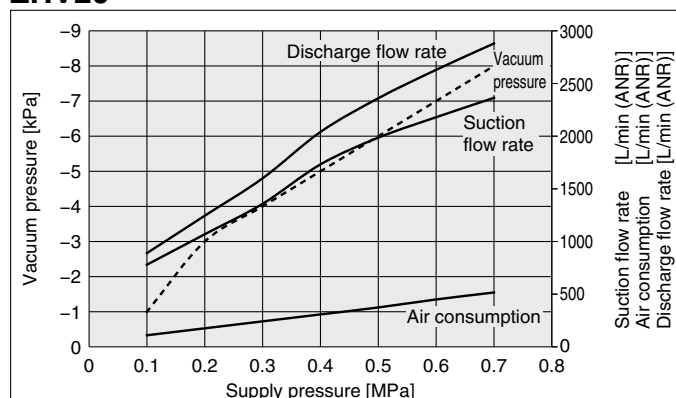

### ZHV30

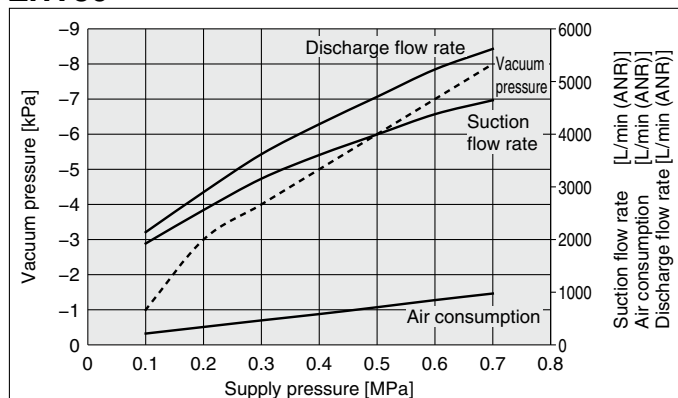

### ZHV40

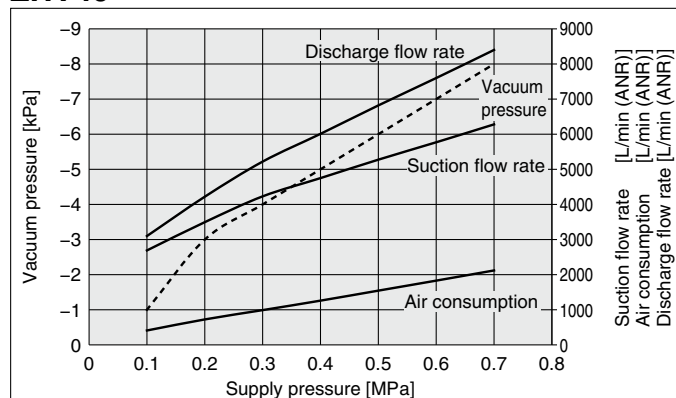

\* Suction flow rate is a theoretical value.

\* The above characteristics are those as of the time of shipment from the factory. The pressure at the discharging part is the value under standard atmospheric pressure.

\* Although the performance of these products is the same as that of the corresponding ZH□-X185 product, various values may be different depending on the measurement method.

**Exhaust Characteristics (at the time of flow rate adjustment, with supply pressure of 0.5 MPa)**

**ZHV10**

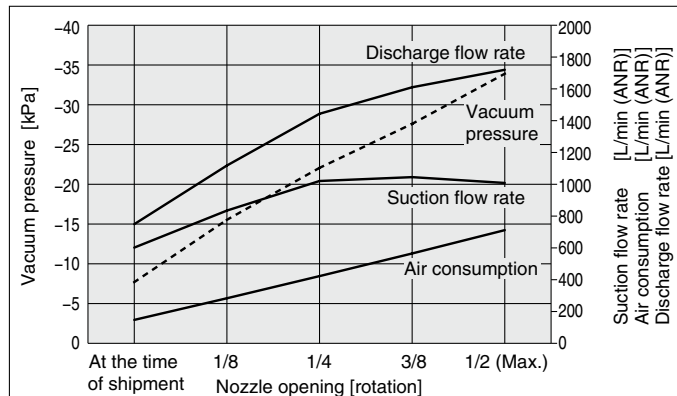

**ZHV20**

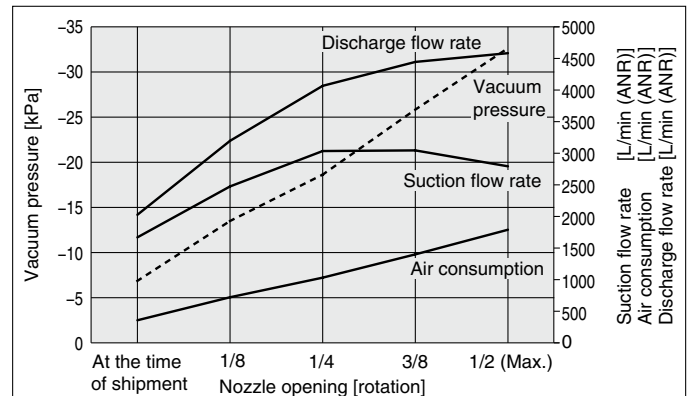

**ZHV30**

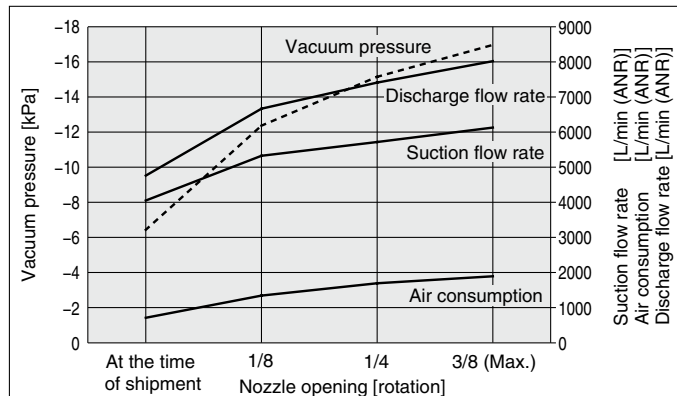



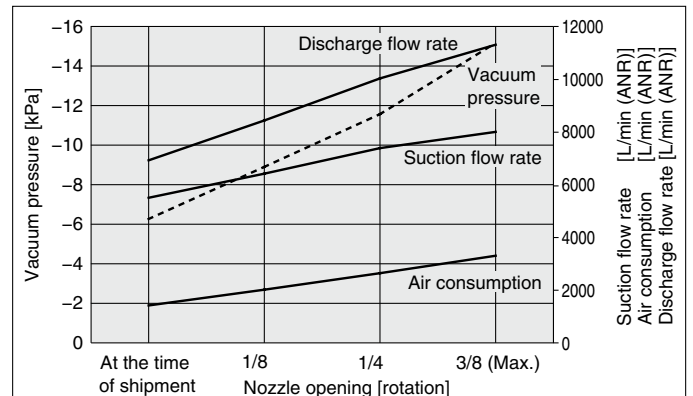

**ZHV40**

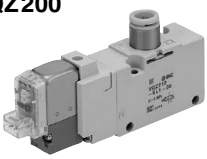

\* Suction flow rate is a theoretical value.  
 \* The above characteristics are when the discharge outlet is under atmospheric pressure.

**Recommended Sonic Conductance and Solenoid Valves (Reference)**

Model	ZHV10	ZHV20	ZHV30	ZHV40
C [dm <sup>3</sup> /(s·bar)]*1	1.48 or more	3.12 or more	5.92 or more	11.08 or more
Solenoid valve (Reference)	 VQZ200 Sonic conductance C [dm <sup>3</sup> /(s·bar)]: 1.7	 VP300 Sonic conductance C [dm <sup>3</sup> /(s·bar)]: 4.2	 VP500 Sonic conductance C [dm <sup>3</sup> /(s·bar)]: 8.9	 VP700 Sonic conductance C [dm <sup>3</sup> /(s·bar)]: 15.3

\*1 This is the total recommended value for all devices on the upstream side including the piping to the valve and vacuum flow.

# ZHV Series

## Dimensions

ZHV<sup>10</sup>/<sub>20</sub>-□□

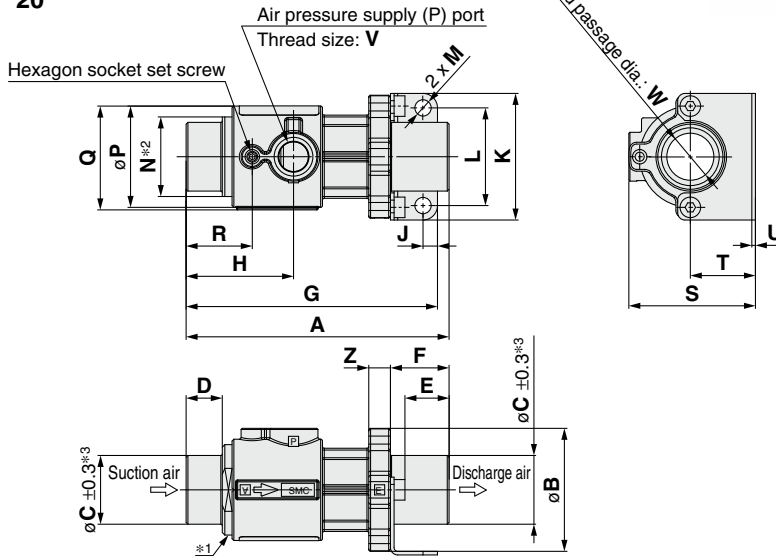

Without bracket

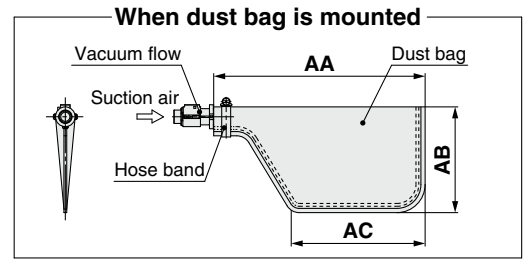
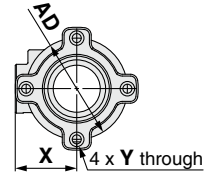

## Dimensions

Model	A	øB	øC	D	E	F	G	H	J	K	L	M	N	øP	Q	R	S	T	U	V	øW	X	Y	Z	AA	AB	AC	øAD
ZHV10-□□	72.7	34	19	10	12.2	16.2	69.5	29.7		35	27	4.5	22	28	28.7	18.3	35	18	1	1/8	13	17	M3 x 0.5	6	300	150	190	28
ZHV20-□□	119	55	32	15	18.5	23.5	110.5	46.2	4	56	48		38	48	48.7	28.1	56.5	29		1/4	21.6	27.5	M4 x 0.7	8	400	200	250	44

ZHV<sup>30</sup>/<sub>40</sub>-□□

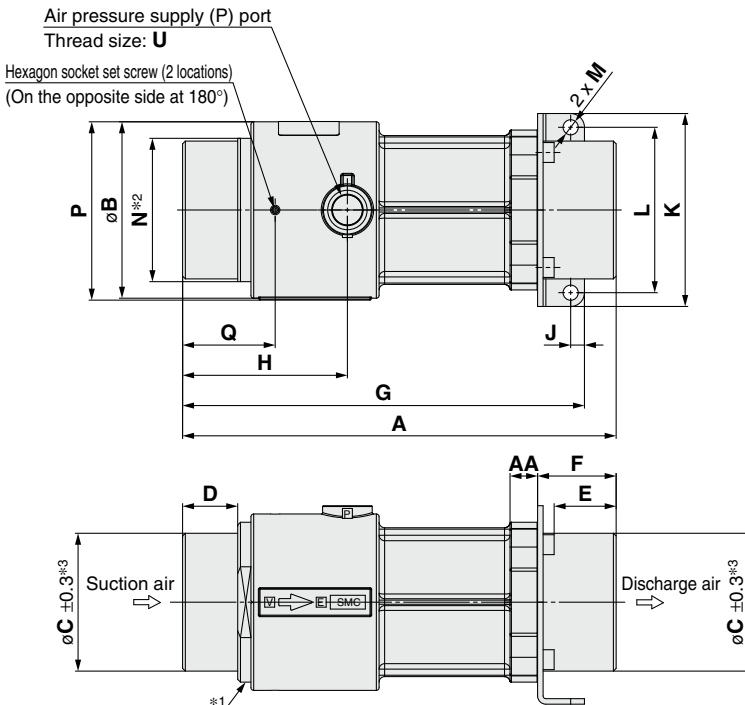

Without bracket

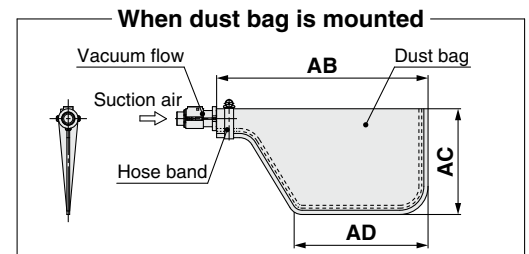
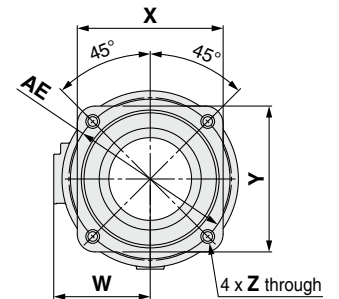

## Dimensions

Model	A	øB	øC	D	E	F	G	H	J	K	L	M	N	P	Q	R	S	T	U	øV	W	X	Y	Z	AA	AB	AC	AD	øAE
ZHV30-□□	157.3	64	50	20	22.5	28.5	145.8	59.8	5	70	60	5.5	52	64.7	33.6	72	37	2	1/4	30	35	52.9	52.9	M4 x 0.7	10	500	250	310	59
ZHV40-□□	201.5	87	64	25	27.2	33.5	195.3	73	6	90	78	6.5	74	87.7	43.4	92	47	2.3	3/8	42	45	67.9	67.9						76

\*1 The nozzle position is set to the catalog specification because of this screw and is fixed by the set screw. Note that if a rotating torque is applied without loosening the set screw or the threaded portion is used for mounting, the set screw may break, or the product's performance may be affected.

\*2 When adjusting the flow rate, check the width across flats dimension N and then use a compatible tool.

For how to make an adjustment, refer to "Flow rate adjustment method" on page 6.

\*3 For how to piping this product, refer to "Piping" on page 6.



## ZHV Series

# Specific Product Precautions

Be sure to read this before handling the products. Refer to the back cover for safety instructions. For vacuum equipment precautions, refer to the “Handling Precautions for SMC Products” and the “Operation Manual” on the SMC website: <https://www.smcworld.com>

### Flow Rate Adjustment Method

It is possible to adjust the suction flow rate, discharge flow rate, and vacuum pressure, by changing the air consumption by following the procedure below.

Hexagon socket set screw (M3)  
ZHV10/20: 1 location  
ZHV30/40: 2 locations

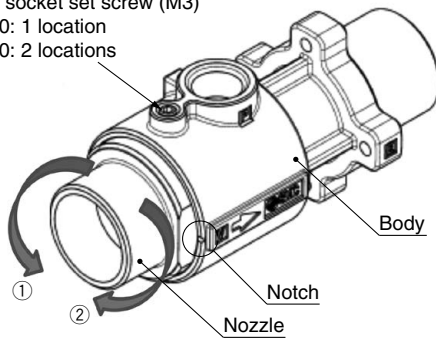

#### Procedure

Loosen the hexagon socket head set screw → turn the nozzle in the direction ① (increasing suction flow rate, discharge flow rate, air consumption, and vacuum pressure) or the direction ② (decreasing suction flow rate, discharge flow rate, air consumption, and vacuum pressure) → tighten the hexagon socket head set screw (M3 tightening torque: 0.6 N·m).

Before adjusting the flow rate, mark the nozzle side alignment with the notch position on the body as a guide for the nozzle rotation amount (adjustment position).

Changing the nozzle position changes the ratio between the air consumption and suction flow rate.

As adjusting the flow rate changes the sonic conductance of the vacuum flow, for selection of solenoid valve and others, contact SMC.

### Caution

Note that if a torque is applied to the nozzle with the hexagon socket head set screw still tightened at the time of adjustment, the hexagon socket head set screw will be subject to a load, which may result in the breakage of the product or a change in performance.

When loosening the hexagon socket head set screw, turn the screw by half up to one turn.

Note that if the hexagon socket head set screw is loosened excessively, the hexagon socket head set screw and nozzle may come off.

### Air Supply

**Use compressed air and control the cleanliness.**

Install an air filter, air dryer, or a mist separator. A system with a quality grade of No. C or higher in the air preparation equipment model selection guide of the **Web Catalog** is recommended.

### Piping

When connecting piping to the suction port and discharge port, we recommend that you use a hose with the same inside diameters as the outside diameters of the suction and discharge ports, both made of a soft material.

If the piping diameter is decreased, the suction flow rate, discharge flow rate, and ultimate vacuum pressure may be lowered.

Note that decreasing the discharge side piping diameter excessively may cause the supply air to flow in reverse to the suction side.

When installing a filter, filtration material, and others for dust collection use on the piping on the discharge side, their performance may degrade due to the effect of the increased back pressure.

If the piping at the suction port is subjected to vibration or impact, the nozzle adjustment position may be displaced, and the product performance may be altered. Therefore, use the product by firmly fixing the piping material and others.

### Vacuum Performance

Although the vacuum performance (air consumption, suction flow rate/discharge flow rate, and vacuum pressure) of this product is same as that of ZH□-X185, the indicated values are changed due to the change in the measurement method.

### Operating Precautions

#### Warning

1. Because suctioned matter is ejected together with the exhaust, do not direct an exhaust port at a person or other equipment.
2. Do not use in an atmosphere which contains corrosive gases, chemicals, organic solvents, sea water, water steam, or where there is direct contact with any of these.

#### Caution

Refer to the back cover for safety instructions and the **Web Catalog** for vacuum equipment precautions.

### Maintenance

1. **Do not disassemble or modify the body of the product.**  
If the disassembled and/or modified, the functions and performance may not be achieved and the product will not be warranted.
2. **In periodical inspections, check the following items and replace the parts if necessary.**
  - a) Scratches, gouges, abrasion, corrosion
  - b) Air leakage (Retighten the fitting and plugs.)
  - c) Twisting, crushing, and turning of connected tubes
  - d) Hardening, deterioration, and softening of connected tubes

## Safety Instructions

These safety instructions are intended to prevent hazardous situations and/or equipment damage. These instructions indicate the level of potential hazard with the labels of “**Caution**,” “**Warning**” or “**Danger**.” They are all important notes for safety and must be followed in addition to International Standards (ISO/IEC)\*1), and other safety regulations.

 **Caution:** **Caution** indicates a hazard with a low level of risk which, if not avoided, could result in minor or moderate injury.

 **Warning:** **Warning** indicates a hazard with a medium level of risk which, if not avoided, could result in death or serious injury.

 **Danger :** **Danger** indicates a hazard with a high level of risk which, if not avoided, will result in death or serious injury.

\*1) ISO 4414: Pneumatic fluid power – General rules relating to systems.  
ISO 4413: Hydraulic fluid power – General rules relating to systems.  
IEC 60204-1: Safety of machinery – Electrical equipment of machines.  
(Part 1: General requirements)  
ISO 10218-1: Manipulating industrial robots – Safety.  
etc.

### Warning

#### 1. The compatibility of the product is the responsibility of the person who designs the equipment or decides its specifications.

Since the product specified here is used under various operating conditions, its compatibility with specific equipment must be decided by the person who designs the equipment or decides its specifications based on necessary analysis and test results. The expected performance and safety assurance of the equipment will be the responsibility of the person who has determined its compatibility with the product. This person should also continuously review all specifications of the product referring to its latest catalog information, with a view to giving due consideration to any possibility of equipment failure when configuring the equipment.

#### 2. Only personnel with appropriate training should operate machinery and equipment.

The product specified here may become unsafe if handled incorrectly. The assembly, operation and maintenance of machines or equipment including our products must be performed by an operator who is appropriately trained and experienced.

#### 3. Do not service or attempt to remove product and machinery/equipment until safety is confirmed.

1. The inspection and maintenance of machinery/equipment should only be performed after measures to prevent falling or runaway of the driven objects have been confirmed.
2. When the product is to be removed, confirm that the safety measures as mentioned above are implemented and the power from any appropriate source is cut, and read and understand the specific product precautions of all relevant products carefully.
3. Before machinery/equipment is restarted, take measures to prevent unexpected operation and malfunction.

#### 4. Contact SMC beforehand and take special consideration of safety measures if the product is to be used in any of the following conditions.

1. Conditions and environments outside of the given specifications, or use outdoors or in a place exposed to direct sunlight.
2. Installation on equipment in conjunction with atomic energy, railways, air navigation, space, shipping, vehicles, military, medical treatment, combustion and recreation, or equipment in contact with food and beverages, emergency stop circuits, clutch and brake circuits in press applications, safety equipment or other applications unsuitable for the standard specifications described in the product catalog.
3. An application which could have negative effects on people, property, or animals requiring special safety analysis.
4. Use in an interlock circuit, which requires the provision of double interlock for possible failure by using a mechanical protective function, and periodical checks to confirm proper operation.

### Caution

#### 1. The product is provided for use in manufacturing industries.

The product herein described is basically provided for peaceful use in manufacturing industries.  
If considering using the product in other industries, consult SMC beforehand and exchange specifications or a contract if necessary.  
If anything is unclear, contact your nearest sales branch.

### Limited warranty and Disclaimer/ Compliance Requirements

The product used is subject to the following “Limited warranty and Disclaimer” and “Compliance Requirements”.

Read and accept them before using the product.

#### Limited warranty and Disclaimer

1. The warranty period of the product is 1 year in service or 1.5 years after the product is delivered, whichever is first.\*2)  
Also, the product may have specified durability, running distance or replacement parts. Please consult your nearest sales branch.
2. For any failure or damage reported within the warranty period which is clearly our responsibility, a replacement product or necessary parts will be provided.  
This limited warranty applies only to our product independently, and not to any other damage incurred due to the failure of the product.
3. Prior to using SMC products, please read and understand the warranty terms and disclaimers noted in the specified catalog for the particular products.

##### \*2) Vacuum pads are excluded from this 1 year warranty.

A vacuum pad is a consumable part, so it is warranted for a year after it is delivered.  
Also, even within the warranty period, the wear of a product due to the use of the vacuum pad or failure due to the deterioration of rubber material are not covered by the limited warranty.

#### Compliance Requirements

1. The use of SMC products with production equipment for the manufacture of weapons of mass destruction (WMD) or any other weapon is strictly prohibited.
2. The exports of SMC products or technology from one country to another are governed by the relevant security laws and regulations of the countries involved in the transaction. Prior to the shipment of a SMC product to another country, assure that all local rules governing that export are known and followed.

### Caution

#### SMC products are not intended for use as instruments for legal metrology.

Measurement instruments that SMC manufactures or sells have not been qualified by type approval tests relevant to the metrology (measurement) laws of each country. Therefore, SMC products cannot be used for business or certification ordained by the metrology (measurement) laws of each country.

 **Safety Instructions** Be sure to read the “Handling Precautions for SMC Products” (M-E03-3) and “Operation Manual” before use.

## SMC Corporation

Akihabara UDX 15F,  
4-14-1, Sotokanda, Chiyoda-ku, Tokyo 101-0021, JAPAN  
Phone: 03-5207-8249 Fax: 03-5298-5362  
<https://www.smcworld.com>  
© 2023 SMC Corporation All Rights Reserved

Specifications are subject to change without prior notice and any obligation on the part of the manufacturer.

D-G