

Air Cylinder

ø20, ø25, ø32, ø40

New

RoHS



| Cylinder with rod end bracket is standardized.

| Interchangeable in mounting with the existing model

Series Variations

Series	Action	Type	Cushion	Bore size [mm]	Option	Made to order
	Double acting	Single rod	Rubber bumper, Air cushion	20 25 32 40	<ul style="list-style-type: none"> Rod end bracket (Single/Double knuckle joint, Rod end) Rod end thread (Male thread, Female thread) 	<ul style="list-style-type: none"> Special port location (-XC3) Made of stainless steel (-XC6□) The mounting nut, bracket, and other components are available in stainless steel (Refer to Construction on page 27). (-XC6B) Grease for food processing equipment (-XC85) PTFE grease (-X446)

CM2 Series



CAT.ES20-269A

Various mounting bracket options

- Mounting brackets suitable for various installation conditions
- Improved mounting flexibility

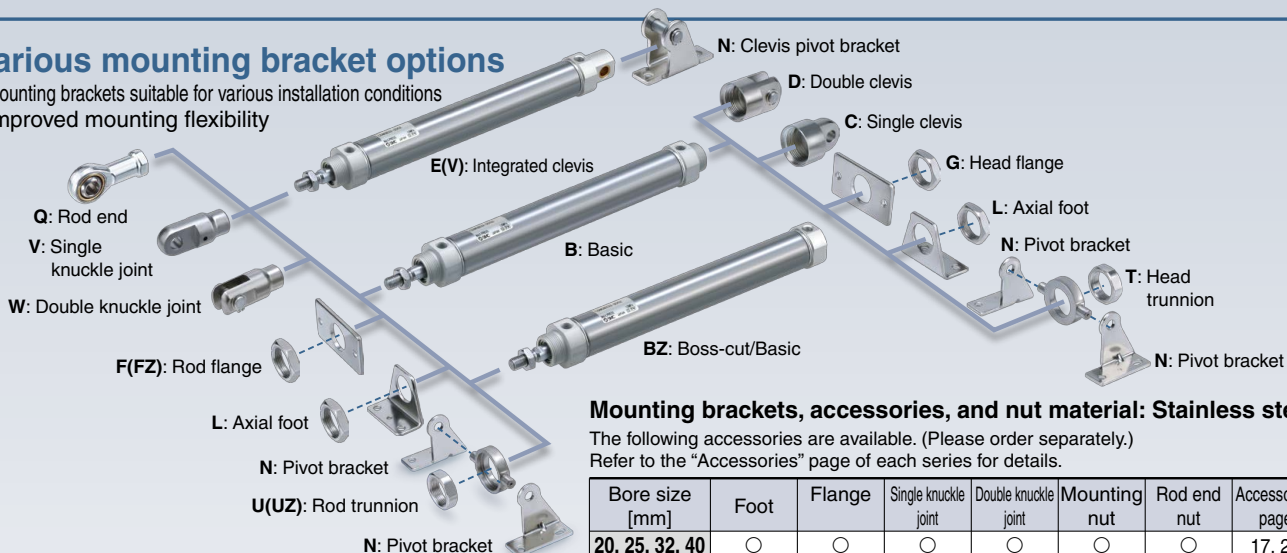

Mounting brackets, accessories, and nut material: Stainless steel

The following accessories are available. (Please order separately.) Refer to the "Accessories" page of each series for details.

Bore size [mm]	Foot	Flange	Single knuckle joint	Double knuckle joint	Mounting nut	Rod end nut	Accessories page
20, 25, 32, 40	○	○	○	○	○	○	17, 27

Part numbers for products with a rod end bracket and/or a pivot bracket available

It is not necessary to order a bracket for the applicable cylinder separately.

* Mounting brackets are shipped together with the product but do not come assembled.

Example) **CDM2E20-50Z1- N W -M9BW**

Pivot bracket	
Nil	No bracket
N	Pivot bracket

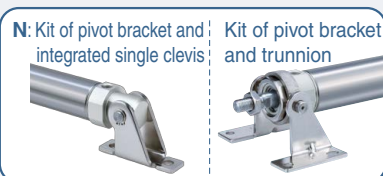

Rod end bracket	
Nil	No bracket
V	Single knuckle joint
W	Double knuckle joint
Q	Rod end

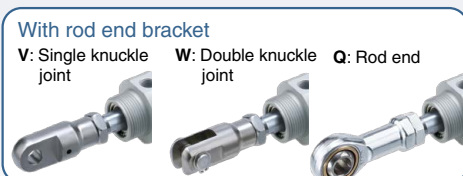

Easy fine adjustment of auto switch position

Fine adjustment of the auto switch set position can be performed by loosening the auto switch attached screw without loosening the auto switch mounting band. Operability improved compared with the existing auto switch set position adjustment, where the complete switch mounting band requires loosening

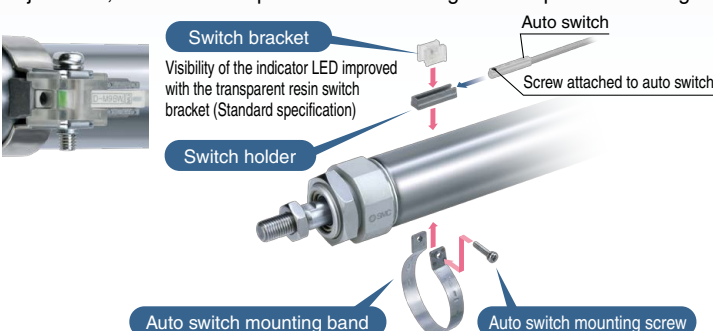

Overall length is shortened with boss-cut type.

Boss for the head cover bracket is eliminated and the overall length of cylinder is shortened.

Overall Length Dimension Comparison (compared to the basic type (B)) [mm]

ø20	ø25	ø32	ø40
-13	-13	-13	-16

Mounting

- Boss-cut/Basic (BZ)
- Boss-cut/Rod flange (FZ)
- Boss-cut/Rod trunnion (UZ)

No environmental hazardous substances used
Compliant with EU RoHS 10 directive

Specifications, performance, and mounting method are the same as those of the existing model.

Environmentally Resistant Specifications

Water Resistant

The use of a special scraper allows for improved water resistance. Water-resistant cylinder (CM2□R/V) **Web Catalog**

Corrosion Resistant

External stainless steel cylinder (-XB12)*1 **Web Catalog**
Fluororubber seal (-XC22)*1 **Web Catalog**

Dust Resistant

Durability is 4 times stronger than the standard model.
Compact cylinder with stable lubrication function (Lube-retainer) (CM2□M)*1 **Web Catalog**

Prevents dust, etc., adhered to the rod from entering the internal parts
With heavy duty scraper (-XC4)*1 **Web Catalog**

Spatter Resistant

With coil scraper (-XC35)*1 **Web Catalog**

Temperature Measures

Heat resistant/Cold resistant cylinder (-XB6, -XB7)*1 **Web Catalog**

Refer to "Operating Environment" in the Actuator Precautions.

*1 The shape (type) is the same as the existing model.

Applications Requiring Lateral Load Resistance



For use in applications in which a lateral load exceeding the allowable value is to be applied, consider using a guide cylinder.

Stroke Variations

Bore size [mm]	Standard stroke								
	25	50	75	100	125	150	200	250	300
20	●	●	●	●	●	●	●	●	●
25	●	●	●	●	●	●	●	●	●
32	●	●	●	●	●	●	●	●	●
40	●	●	●	●	●	●	●	●	●

Series Variations

* For details about the clean series, refer to the **Web Catalog**.

Series	Action	Type	Cushion	Bore size [mm]				Variations			Page	
				20	25	32	40	With rod boot	Air-hydro	Clean series		
 Standard CM2-Z1	Double acting	Single rod	Rubber bumper	●	●	●	●				3	
			Air cushion	●	●	●	●					
 Standard CM2-Z	Double acting	Single rod	Rubber bumper	●	●	●	●	●	●	●	Web Catalog	
			Air cushion	●	●	●	●	●		●		
	Double acting	Double rod	Rubber bumper	●	●	●	●	●	●			
			Air cushion	●	●	●	●	●				
Single acting	Single rod (Spring return/extend)	Rubber bumper	●	●	●	●						
		Double acting	Single rod	Rubber bumper	●	●	●	●	●			
				Air cushion	●	●	●	●	●			
Double acting	Double rod	Rubber bumper	●	●	●	●						
		Air cushion	●	●	●	●						
Single acting	Single rod (Spring return/extend)	Rubber bumper	●	●	●	●						
		Double acting	Single rod	Rubber bumper	●	●	●	●		●	●	
				Air cushion	●	●	●	●				
Double acting	Single rod	Rubber bumper	●	●	●	●						
		Air cushion	●	●	●	●						
Double acting	Single rod	Rubber bumper	●	●	●	●						
		Air cushion	●	●	●	●						
Double acting	Single rod	Rubber bumper	●	●	●	●	●					
		Air cushion	●	●	●	●	●					
Double acting	Single rod	Rubber bumper	●	●	●	●			●			
		Air cushion	●	●	●	●			Locked in head end only			
Double acting	Single rod	Rubber bumper	●	●	●	●						
		Air cushion	●	●	●	●						
Double acting	Single rod	Rubber bumper	●	●	●	●						
		Air cushion	●	●	●	●						

CONTENTS

How to Order	p. 3	Made to Order Common Specifications	
Specifications	p. 4	Special Port Location	p. 26
Construction	p. 7	Made of Stainless Steel	p. 26
Dimensions	p. 8	Grease for Food Processing Equipment	p. 28
Dimensions of Accessories	p. 17	PTFE Grease	p. 28
Auto Switch Mounting	p. 21	Specific Product Precautions	p. 29
Prior to Use: Auto Switch Connections and Examples	p. 25		

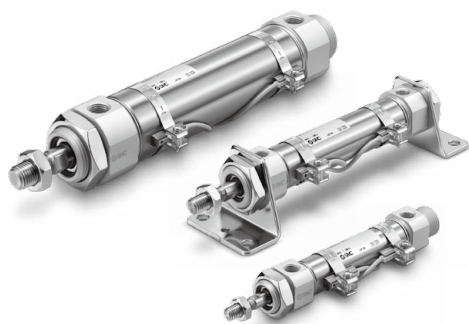

Symbol

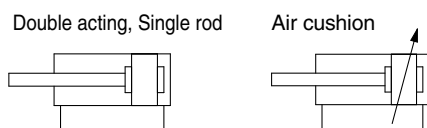

Refer to pages 21 to 24 for cylinders with auto switches.

- Auto Switch Proper Mounting Position (Detection at stroke end) and Mounting Height
- Minimum Stroke for Auto Switch Mounting
- Operating Range
- Auto Switch Mounting Brackets/Part Nos.



Made to Order Common Specifications (For details, refer to page 26.)

Symbol	Specifications
-XC3	Special port location
-XC6□	Made of stainless steel
-XC85	Grease for food processing equipment
-X446	PTFE grease

Specifications

Bore size [mm]	20	25	32	40		
Type	Pneumatic					
Action	Double acting, Single rod					
Fluid	Air					
Proof pressure	1.5 MPa					
Max. operating pressure	1.0 MPa					
Min. operating pressure	0.05 MPa					
Ambient and fluid temperatures	Without auto switch: -10°C to 70°C With auto switch: -10°C to 60°C (No freezing)					
Lubrication	Not required (Non-lube)					
Stroke length tolerance*1	+1.4 mm 0					
Piston speed	Rubber bumper: 50 to 750 mm/s, Air cushion: 50 to 1000 mm/s					
Cushion	Rubber bumper, Air cushion					
Allowable kinetic energy	Rubber bumper	Male thread	0.27 J	0.4 J	0.65 J	1.2 J
		Female thread	0.11 J	0.18 J	0.29 J	0.52 J
	Air cushion (Effective cushion length [mm])	Male thread	0.54 J (11.0)	0.78 J (11.0)	1.27 J (11.0)	2.35 J (11.8)
		Female thread	0.11 J	0.18 J	0.29 J	0.52 J

- *1 Does not include the amount of bumper change
- * Operate the cylinder within the allowable kinetic energy.
- * For the allowable rod end lateral load, refer to the "Air Cylinders Model Selection" in the **Web Catalog**.

Standard Strokes

Bore size [mm]	Standard stroke [mm]*1	Max. manufacturable stroke [mm]
20	25, 50, 75, 100, 125, 150, 200, 250, 300	1000
25		
32		
40		

- *1 Intermediate strokes not listed above are produced upon receipt of order. The manufacturing of intermediate strokes in 1 mm increments is possible. (Spacers are not used.)
- * Applicable strokes should be confirmed according to the usage. For details, refer to the "Air Cylinders Model Selection" in the **Web Catalog**. In addition, the products that exceed the standard stroke might not be able to fulfill the specifications due to deflection, etc.
- * Using a stroke of a length which is smaller than the effective cushion length may result in reduced air cushion performance. Refer to "Technical Data 1" in the **Web Catalog** for details on the effective cushion length.

Option: Ordering Example of Cylinder Assembly

Cylinder model: CDM2C20-50Z1-NV-M9BW

Mounting C: Single clevis
Pivot bracket N: Yes
Rod end bracket V: Single knuckle joint
Auto switch D-M9BW: 2 pcs.

- * Pivot bracket, single knuckle joint and auto switch are shipped together with the product but do not come assembled.
- * Pivot bracket is only available for C, T, U, E, V, and UZ mounting types.
- * No bracket is provided for the female rod end.

⚠ Precautions

Refer to page 29 before handling.

CM2 Series

Mounting and Accessories

Accessories	Body	Standard (mounted to the body)					Standard (packaged together but does not come assembled)							Option					
		Mounting nut *2	Rod end nut (Male thread)	Single clevis	Double clevis	Liner *7	Mounting nut	Foot	Flange	Pivot bracket *5	Pivot bracket pin *5	Double clevis pin *5	Trunnion	Mounting nut (For trunnion)	Clevis pivot bracket (CM2E/CM2V)	Clevis pivot bracket pin (CM2E/CM2V)	Single knuckle joint (Male thread only)	Double knuckle joint (Male thread only)	Rod end
B Basic (Double-side bossed)	●(1 pc.)	●(1 pc.)	●(1 pc.)	—	—	—	—	—	—	—	—	—	—	—	—	—	●	●	●
L Axial foot	●(1 pc.)	●(1 pc.) ^{*2}	●(1 pc.)	—	—	—	●(1 pc.) ^{*2}	●(2 pcs.)	—	—	—	—	—	—	—	—	●	●	●
F Rod flange	●(1 pc.)	●(1 pc.)	●(1 pc.)	—	—	—	—	—	●(1 pc.)	—	—	—	—	—	—	—	●	●	●
G Head flange	●(1 pc.)	●(1 pc.)	●(1 pc.)	—	—	—	—	—	●(1 pc.)	—	—	—	—	—	—	—	●	●	●
C Single clevis	●(1 pc.)	—*3	●(1 pc.)	●(1 pc.)	—	●(Max. 3 pcs.)	—*3	—	—	—	—	—	—	—	—	—	●	●	●
D Double clevis	●(1 pc.)	—*3	●(1 pc.)	—	●(1 pc.)	●(Max. 3 pcs.)	—*3	—	—	—	●(1 pc.)	—	—	—	—	—	●	●	●
U Rod trunnion	●(1 pc.)	—*4	●(1 pc.)	—	—	—	—	—	—	—	—	●(1 pc.)	●(1 pc.)	—	—	—	●	●	●
T Head trunnion	●(1 pc.)	—*4	●(1 pc.)	—	—	—	—	—	—	—	—	●(1 pc.)	●(1 pc.)	—	—	—	●	●	●
E Integrated clevis	●(1 pc.)	—*3	●(1 pc.)	—	—	—	—*3	—	—	—	—	—	—	—	—	—	●	●	●
V Integrated clevis (90°)	●(1 pc.)	—*3	●(1 pc.)	—	—	—	—*3	—	—	—	—	—	—	—	—	—	●	●	●
BZ Boss-cut/Basic	●(1 pc.)	●(1 pc.)	●(1 pc.)	—	—	—	—	—	—	—	—	—	—	—	—	—	●	●	●
FZ Boss-cut/ Rod flange	●(1 pc.)	●(1 pc.)	●(1 pc.)	—	—	—	—	—	●(1 pc.)	—	—	—	—	—	—	—	●	●	●
UZ Boss-cut/ Rod trunnion	●(1 pc.)	—*4	●(1 pc.)	—	—	—	—	—	—	—	—	●(1 pc.)	●(1 pc.)	—	—	—	●	●	●

	Standard (mounted to the body)					Option													
Mounting: C Pivot bracket symbol: N Single clevis + Pivot bracket + Pin	●(1 pc.)	—*3	●(1 pc.)	●(1 pc.)	—	●(Max. 3 pcs.)	—*3	—	—	●(2 pcs.)	●(1 pc.)	—	—	—	—	—	●	●	●
Mounting: T, U, UZ Pivot bracket symbol: N Trunnion + Pivot bracket	●(1 pc.)	—*4	●(1 pc.)	—	—	—	—*3	—	—	●(2 pcs.)	—	—	●(1 pc.)	●(1 pc.)	—	—	●	●	●
Mounting: E Pivot bracket symbol: N Integrated clevis + Pivot bracket + Pin	●(1 pc.)	—*3	●(1 pc.)	—	—	—	—*3	—	—	—	—	—	—	●(1 pc.)	●(1 pc.)	—	●	●	●
Mounting: V Pivot bracket symbol: N Integrated clevis (90°) + Pivot bracket + Pin	●(1 pc.)	—*3	●(1 pc.)	—	—	—	—*3	—	—	—	—	—	—	●(1 pc.)	●(1 pc.)	—	●	●	●

- *1 Rod end nut is not provided for the female rod end.
- *2 Two mounting nuts are packaged together.
- *3 Mounting nut is not packaged for the clevis.
- *4 Trunnion nut is packaged for U, T, and UZ.
- *5 Retaining rings are included.

- *6 A pin and retaining rings (split pins for ø40) are included.
- *7 This is the part(s) used to adjust the clevis angle. Mounting quantity can vary.
- * Stainless steel mounting brackets and accessories are also available.
Refer to page 27 for details.

Mounting Brackets/Part Nos.

Mounting bracket	Min. order quantity	Bore size [mm]				Contents (for min. order quantity)
		20	25	32	40	
Foot*1	2	CM-L020B	CM-L032B	CM-L040B	2 foot brackets, 1 mounting nut	
Foot*2	1	CMZ1-L020B	CMZ1-L032B	CMZ1-L040B	1 foot bracket	
Flange	1	CM-F020B	CM-F032B	CM-F040B	1 flange	
Single clevis*3	1	CM-C020B	CM-C032B	CM-C040B	1 single clevis, 3 liners	
Double clevis (with pin)*3, *4	1	CM-D020B	CM-D032B	CM-D040B	1 double clevis, 3 liners, 1 clevis pin, 2 retaining rings	
Double clevis pin	1	CDP-1		CDP-2	1 clevis pin, 2 retaining rings (split pins)	
Trunnion (with nut)	1	CM-T020B	CM-T032B	CM-T040B	1 trunnion, 1 trunnion nut	
Rod end nut	1	NT-02	NT-03	NT-04	1 rod end nut	
Mounting nut	1	SN-020B	SN-032B	SN-040B	1 mounting nut	
Trunnion nut	1	TN-020B	TN-032B	TN-040B	1 trunnion nut	
Single knuckle joint	1	I-020B	I-032B	I-040B	1 single knuckle joint	
Double knuckle joint	1	Y-020B	Y-032B	Y-040B	1 double knuckle joint, 1 knuckle pin, 2 retaining rings	
Rod end	1	KJ8D	KJ10D	KJ14D	1 rod end	
Double knuckle joint pin	1	CDP-1		CDP-3	1 knuckle pin, 2 retaining rings (split pins)	
Clevis pivot bracket pin (For CM2E/CM2V)	1	CD-S02		CD-S03	1 clevis pin, 2 retaining rings	
Clevis pivot bracket (For CM2E/CM2V)	1	CM-E020B		CM-E032B	1 clevis pivot bracket, 1 clevis pin, 2 retaining rings	
Pivot bracket (For CM2C)	1	CM-B032		CM-B040	2 pivot brackets (1 of each type)	
Pivot bracket pin (For CM2C)	1	CDP-1		CD-S03	1 pin, 2 retaining rings	
Pivot bracket (For CM2T/CM2U)	1	CM-B020	CM-B032	CM-B040	2 pivot brackets (1 of each type)	

- *1 Order two foot brackets per cylinder.
- *2 A single foot is available.
- *3 3 liners are included with a clevis bracket for adjusting the mounting angle.
- *4 A clevis pin and retaining rings (split pins for ø40) are included.

For dimensions of accessories (options), refer to pages 17 to 20.

Mounting Brackets, Accessories/Material, Surface Treatment

Segment	Description	Material	Surface treatment
Mounting brackets	Foot	Carbon steel	Nickel plating
	Flange	Carbon steel	Nickel plating
	Single clevis	Carbon steel	Electroless nickel plating
	Double clevis	Carbon steel	Electroless nickel plating
	Trunnion	Cast iron	Electroless nickel plating
Accessories	Rod end nut	Carbon steel	Zinc chromating
	Mounting nut	Carbon steel	Nickel plating
	Trunnion nut	Carbon steel	Nickel plating
	Clevis pivot bracket	Carbon steel	Nickel plating
	Clevis pivot bracket pin	Carbon steel	(None)
	Single knuckle joint	Carbon steel ø40: Free-cutting steel	Electroless nickel plating
	Double knuckle joint	Carbon steel ø40: Cast iron	Electroless nickel plating Metallic silver color painting for ø40
	Rod end	Carbon steel	Zinc plating
	Double clevis pin	Carbon steel	(None)
	Double knuckle joint pin	Carbon steel	(None)
	Pivot bracket	Carbon steel	Nickel plating
	Pivot bracket pin	Carbon steel	(None)

Weight

		[kg]			
Bore size [mm]		20	25	32	40
Basic weight	Basic (Double-side bossed)	0.14	0.21	0.28	0.56
	Axial foot	0.29	0.37	0.44	0.83
	Flange	0.20	0.30	0.37	0.68
	Integrated clevis	0.12	0.19	0.27	0.52
	Single clevis	0.18	0.25	0.32	0.65
	Double clevis	0.19	0.27	0.33	0.69
	Trunnion	0.18	0.28	0.34	0.66
	Boss-cut/Basic	0.13	0.19	0.26	0.53
	Boss-cut/Flange	0.19	0.28	0.35	0.65
	Boss-cut/Trunnion	0.17	0.26	0.32	0.63
Additional weight per 50 mm of stroke		0.04	0.06	0.08	0.13
Weight reduction for female rod end		-0.01	-0.02	-0.02	-0.04
Option bracket	Clevis pivot bracket (with pin)	0.07	0.07	0.14	0.14
	Single knuckle joint	0.06	0.06	0.06	0.23
	Double knuckle joint (with pin)	0.07	0.07	0.07	0.20
	Rod end	0.05	0.07	0.07	0.16
	Pivot bracket	0.06	0.06	0.06	0.06
	Pivot bracket pin	0.02	0.02	0.02	0.03

Calculation: (Example) **CM2L32-100Z1**

- Basic weight.....0.44 (Foot, ø32)
- Additional weight.....0.08/50 mm stroke
- Cylinder stroke.....100 mm stroke

$$0.44 + 0.08 \times 100/50 = \mathbf{0.60 \text{ kg}}$$

CM2 Series

Construction

Rubber bumper

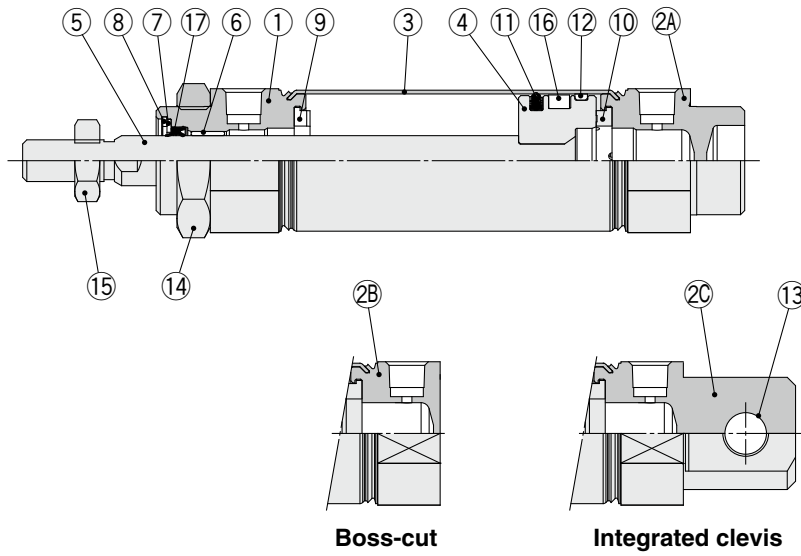

With air cushion

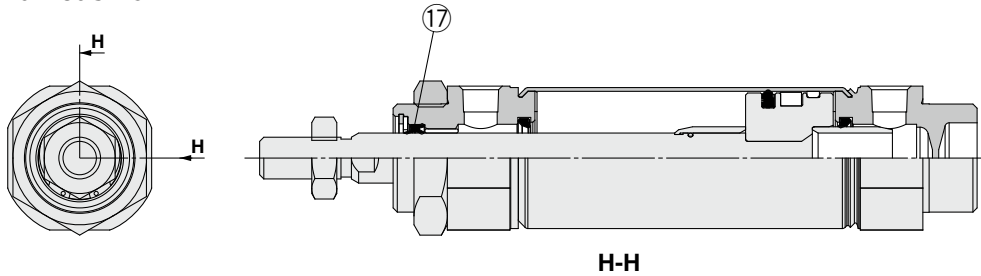

Component Parts

No.	Description	Material	Note
1	Rod cover	Aluminum alloy	Anodized
2A	Head cover A	Aluminum alloy	Anodized
2B	Head cover B	Aluminum alloy	Anodized
2C	Head cover C	Aluminum alloy	Anodized
3	Cylinder tube	Stainless steel	
4	Piston	Aluminum alloy	
5	Piston rod	Carbon steel	Hard chrome plating
6	Bushing	Bearing alloy	
7	Seal retainer	Stainless steel	
8	Retaining ring	Carbon steel	Phosphate coating
9	Bumper	Resin	
10	Bumper	Resin	
11	Piston seal	NBR	

No.	Description	Material	Note
12	Wear ring	Resin	
13	Clevis bushing	Bearing alloy	
14	Mounting nut	Carbon steel	Nickel plating
15	Rod end nut	Carbon steel	Zinc chromating
16	Magnet	—	CDM2□20 to 40-□Z1
17	Rod seal	NBR	

Replacement Parts: Seal

● With Rubber Bumper/With Air Cushion

No.	Description	Material	Part no.			
			20	25	32	40
7	Seal retainer	Stainless steel	CM-SR20Z	CM-SR25Z	CM-SR32Z	CM-SR40Z
8	Retaining ring	Carbon steel	CM-R20	CM-R25	CM-R32	CM-R40
		Stainless steel	CM-R20SUS	CM-R25SUS	CM-R32SUS	CM-R40SUS
17	Rod seal	NBR	CM20Z-PS	CM25Z-PS	CM32Z-PS	CM40Z-PS

* Since the seal does not include a grease pack, order it separately.
Grease pack part number: GR-S-010 (10 g)

Basic (Double-side Bossed) (B)

CM2B —

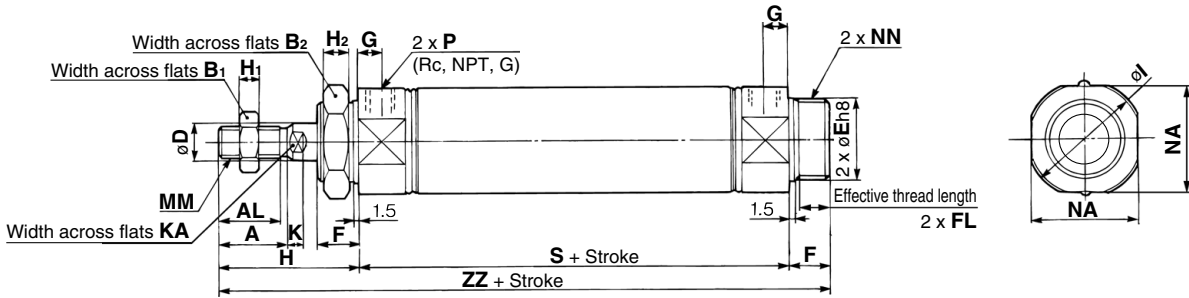

With air cushion

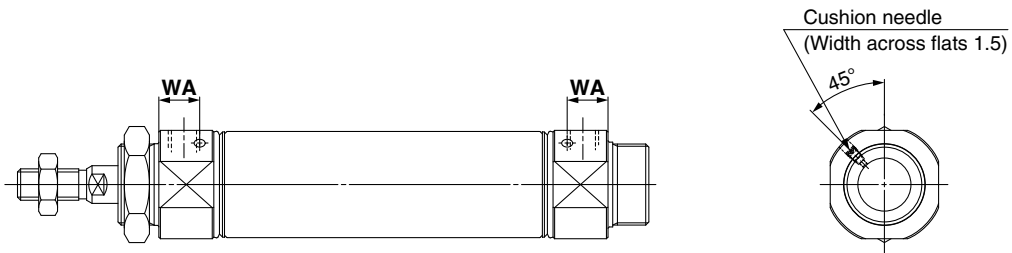

Boss-cut

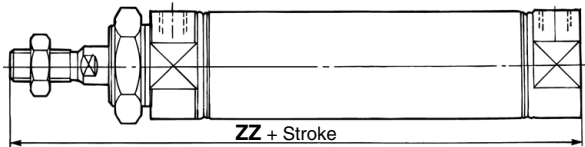

Female rod end

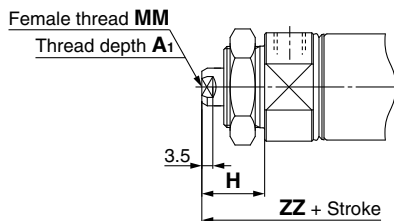

Bore size	A	AL	B ₁	B ₂	D	E	F	FL	G	H	H ₁	H ₂	I	K	KA	MM	NA	NN	P	S	ZZ
20	18	15.5	13	26	8	20 ⁰ _{-0.033}	13	10.5	8	41	5	8	28	5	6	M8 x 1.25	24	M20 x 1.5	1/8	62	116
25	22	19.5	17	32	10	26 ⁰ _{-0.033}	13	10.5	8	45	6	8	33.5	5.5	8	M10 x 1.25	30	M26 x 1.5	1/8	62	120
32	22	19.5	17	32	12	26 ⁰ _{-0.033}	13	10.5	8	45	6	8	37.5	5.5	10	M10 x 1.25	34.5	M26 x 1.5	1/8	64	122
40	24	21	22	41	14	32 ⁰ _{-0.039}	16	13.5	11	50	8	10	46.5	7	12	M14 x 1.5	42.5	M32 x 2	1/4	88	154

With Air Cushion [mm]

Bore size	WA
20	12
25	12
32	11
40	16

Boss-cut [mm]

Bore size	ZZ
20	103
25	107
32	109
40	138

Female Rod End [mm]

Bore size	A ₁	H	MM	ZZ
20	8	20	M4 x 0.7	95
25	8	20	M5 x 0.8	95
32	12	20	M6 x 1	97
40	13	21	M8 x 1.25	125

- * When a female thread is used, use a thin wrench when tightening the piston rod.
- * When a female thread is used, depending on the material of the workpiece, use a washer etc., to prevent the contact part at the rod end from being deformed.

CM2 Series

Axial Foot (L)

CM2L Bore size — Stroke Z1

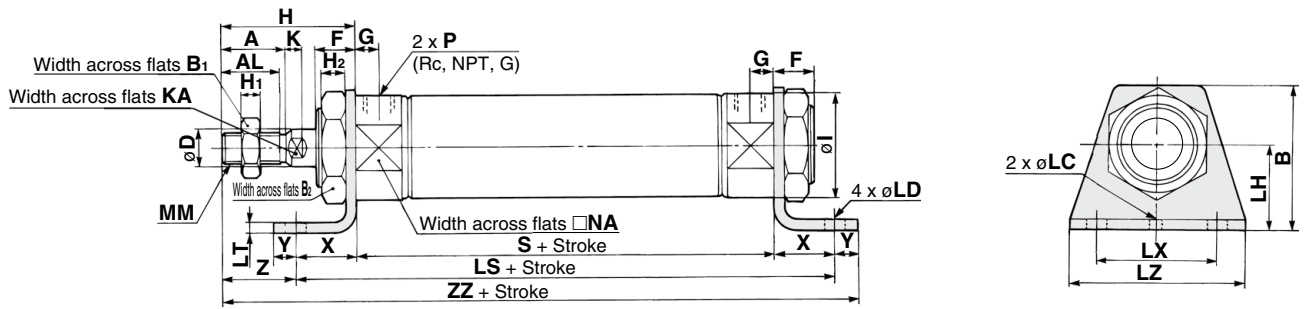

With air cushion

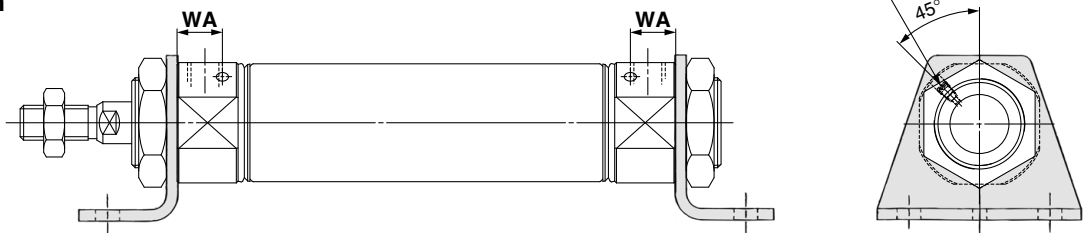

Female rod end

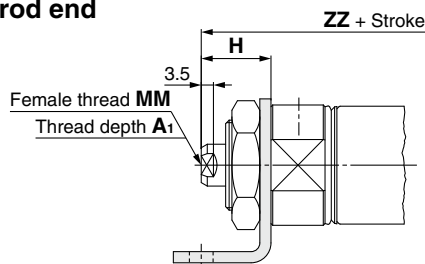

Bore size	A	AL	B	B ₁	B ₂	D	F	G	H	H ₁	H ₂	I	K	KA	LC	LD	LH	LS	LT	LX	LZ	MM	NA	P	S	X	Y	Z	ZZ
20	18	15.5	40	13	26	8	13	8	41	5	8	28	5	6	4	6.8	25	102	3.2	40	55	M8 x 1.25	24	1/8	62	20	8	21	131
25	22	19.5	47	17	32	10	13	8	45	6	8	33.5	5.5	8	4	6.8	28	102	3.2	40	55	M10 x 1.25	30	1/8	62	20	8	25	135
32	22	19.5	47	17	32	12	13	8	45	6	8	37.5	5.5	10	4	6.8	28	104	3.2	40	55	M10 x 1.25	34.5	1/8	64	20	8	25	137
40	24	21	54	22	41	14	16	11	50	8	10	46.5	7	12	4	7	30	134	3.2	55	75	M14 x 1.5	42.5	1/4	88	23	10	27	171

With Air Cushion [mm]

Bore size	WA
20	12
25	12
32	11
40	16

Female Rod End [mm]

Bore size	A ₁	H	MM	ZZ
20	8	20	M4 x 0.7	110
25	8	20	M5 x 0.8	110
32	12	20	M6 x 1	112
40	13	21	M8 x 1.25	142

- * When a female thread is used, use a thin wrench when tightening the piston rod.
- * When a female thread is used, depending on the material of the workpiece, use a washer etc., to prevent the contact part at the rod end from being deformed.

* The bracket is shipped together with the product.

Rod Flange (F)

CM2F Bore size — Stroke Z1

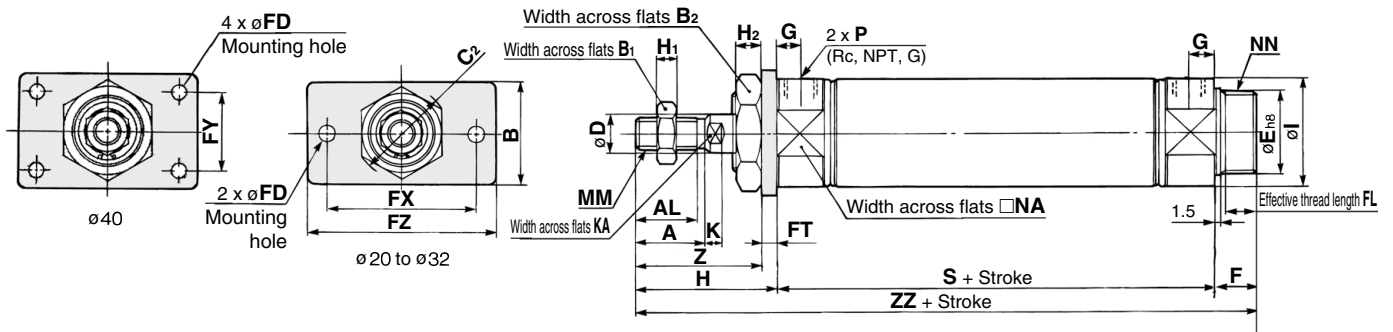

Boss-cut

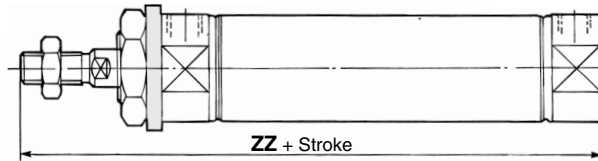

With air cushion

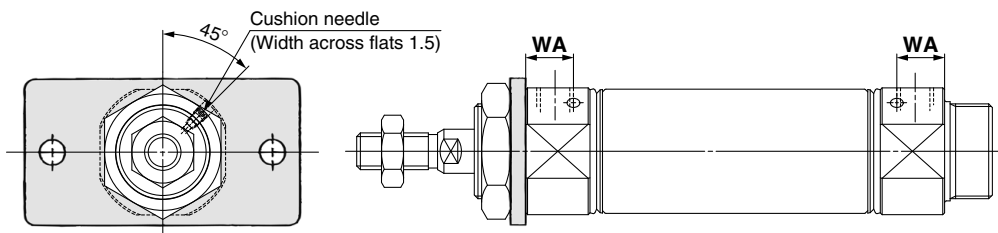

Female rod end

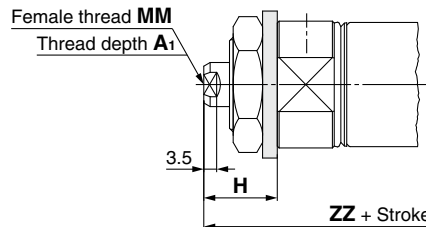

Bore size	A	AL	B	B ₁	B ₂	C ₂	D	E	F	FL	FD	FT	FX	FY	FZ	G	H	H ₁	H ₂	I	K	KA	MM	NA	NN	P	S	Z	ZZ
20	18	15.5	34	13	26	30	8	20 ⁰ _{-0.033}	13	10.5	7	4	60	—	75	8	41	5	8	28	5	6	M8 x 1.25	24	M20 x 1.5	1/8	62	37	116
25	22	19.5	40	17	32	37	10	26 ⁰ _{-0.033}	13	10.5	7	4	60	—	75	8	45	6	8	33.5	5.5	8	M10 x 1.25	30	M26 x 1.5	1/8	62	41	120
32	22	19.5	40	17	32	37	12	26 ⁰ _{-0.033}	13	10.5	7	4	60	—	75	8	45	6	8	37.5	5.5	10	M10 x 1.25	34.5	M26 x 1.5	1/8	64	41	122
40	24	21	52	22	41	47.3	14	32 ⁰ _{-0.039}	16	13.5	7	5	66	36	82	11	50	8	10	46.5	7	12	M14 x 1.5	42.5	M32 x 2	1/4	88	45	154

Boss-cut [mm]

Bore size	ZZ
20	103
25	107
32	109
40	138

With Air Cushion [mm]

Bore size	WA
20	12
25	12
32	11
40	16

Female Rod End [mm]

Bore size	A ₁	H	MM	ZZ
20	8	20	M4 x 0.7	95
25	8	20	M5 x 0.8	95
32	12	20	M6 x 1	97
40	13	21	M8 x 1.25	125

- * When a female thread is used, use a thin wrench when tightening the piston rod.
- * When a female thread is used, depending on the material of the workpiece, use a washer etc., to prevent the contact part at the rod end from being deformed.

* The bracket is shipped together with the product.

CM2 Series

Head Flange (G)

CM2G —

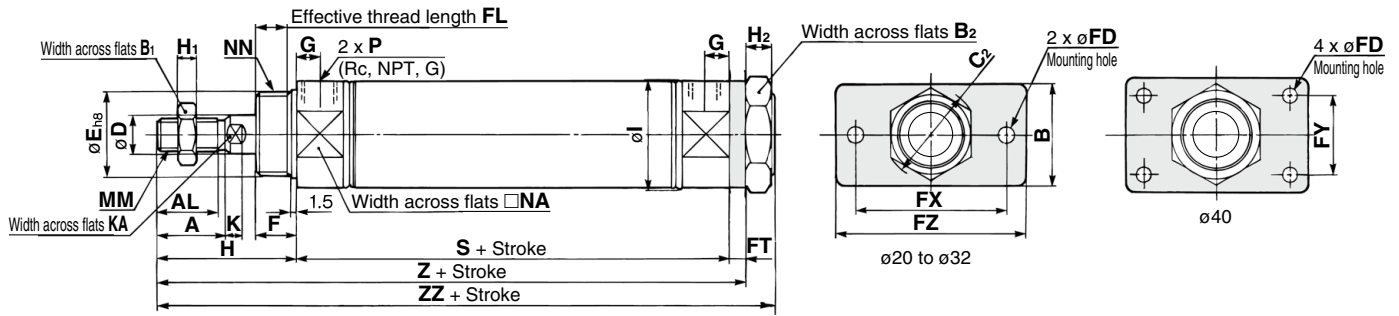

With air cushion

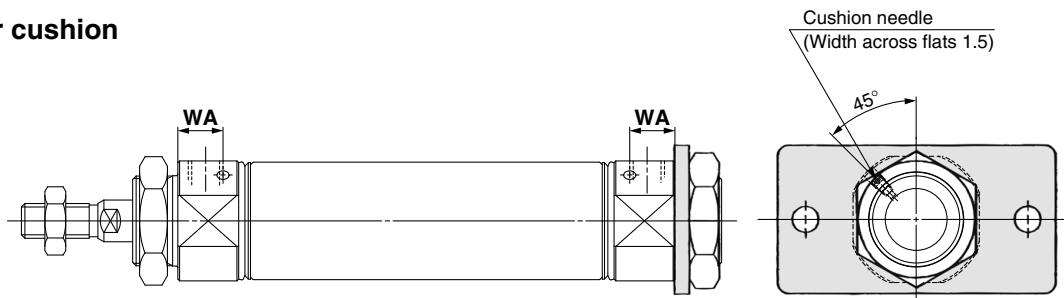

Female rod end

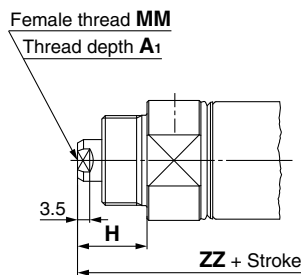

Bore size	A	AL	B	B_1	B_2	C_2	D	E	F	FL	FD	FT	FX	FY	FZ	G	H	H_1	H_2	I
20	18	15.5	34	13	26	30	8	$20_{-0.033}^0$	13	10.5	7	4	60	—	75	8	41	5	8	28
25	22	19.5	40	17	32	37	10	$26_{-0.033}^0$	13	10.5	7	4	60	—	75	8	45	6	8	33.5
32	22	19.5	40	17	32	37	12	$26_{-0.033}^0$	13	10.5	7	4	60	—	75	8	45	6	8	37.5
40	24	21	52	22	41	47.3	14	$32_{-0.039}^0$	16	13.5	7	5	66	36	82	11	50	8	10	46.5

Bore size	K	KA	MM	NA	NN	P	S	Z	ZZ
20	5	6	M8 x 1.25	24	M20 x 1.5	1/8	62	107	116
25	5.5	8	M10 x 1.25	30	M26 x 1.5	1/8	62	111	120
32	5.5	10	M10 x 1.25	34.5	M26 x 1.5	1/8	64	113	122
40	7	12	M14 x 1.5	42.5	M32 x 2	1/4	88	143	154

With Air Cushion [mm]

Bore size	WA
20	12
25	12
32	11
40	16

Female Rod End [mm]

Bore size	A_1	H	MM	ZZ
20	8	20	M4 x 0.7	95
25	8	20	M5 x 0.8	95
32	12	20	M6 x 1	97
40	13	21	M8 x 1.25	125

- * When a female thread is used, use a thin wrench when tightening the piston rod.
- * When a female thread is used, depending on the material of the workpiece, use a washer etc., to prevent the contact part at the rod end from being deformed.

* The bracket is shipped together with the product.

Single Clevis (C)

CM2C Bore size — Stroke Z1

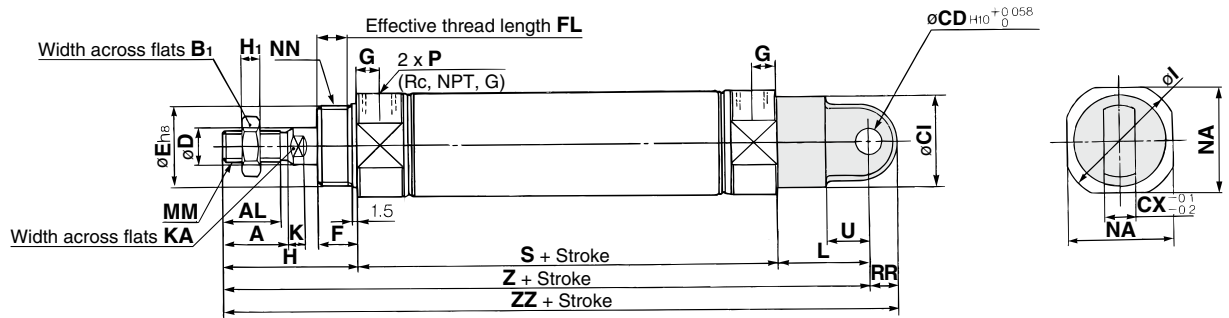

With air cushion

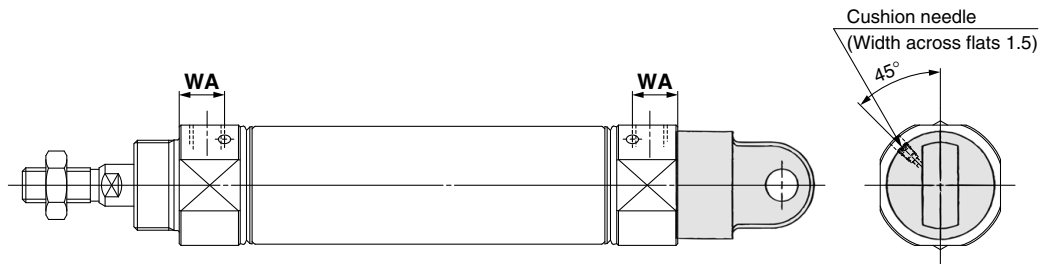

Female rod end

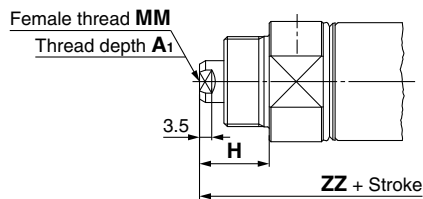

Bore size	A	AL	B ₁	CI	CD	CX	D	E	F	FL	G	H	H ₁	I	K	KA	L	MM	NA	NN	P	RR	S	U	Z	ZZ
20	18	15.5	13	24	9	10	8	20 ⁰ _{-0.033}	13	10.5	8	41	5	28	5	6	30	M8 x 1.25	24	M20 x 1.5	1/8	9	62	14	133	142
25	22	19.5	17	30	9	10	10	26 ⁰ _{-0.033}	13	10.5	8	45	6	33.5	5.5	8	30	M10 x 1.25	30	M26 x 1.5	1/8	9	62	14	137	146
32	22	19.5	17	30	9	10	12	26 ⁰ _{-0.033}	13	10.5	8	45	6	37.5	5.5	10	30	M10 x 1.25	34.5	M26 x 1.5	1/8	9	64	14	139	148
40	24	21	22	38	10	15	14	32 ⁰ _{-0.039}	16	13.5	11	50	8	46.5	7	12	39	M14 x 1.5	42.5	M32 x 2	1/4	11	88	18	177	188

With Air Cushion [mm]

Bore size	WA
20	12
25	12
32	11
40	16

Female Rod End [mm]

Bore size	A ₁	H	MM	ZZ
20	8	20	M4 x 0.7	121
25	8	20	M5 x 0.8	121
32	12	20	M6 x 1	123
40	13	21	M8 x 1.25	159

- * When a female thread is used, use a thin wrench when tightening the piston rod.
- * When a female thread is used, depending on the material of the workpiece, use a washer etc., to prevent the contact part at the rod end from being deformed.

CM2 Series

Double Clevis (D)

CM2D Bore size — Stroke Z1

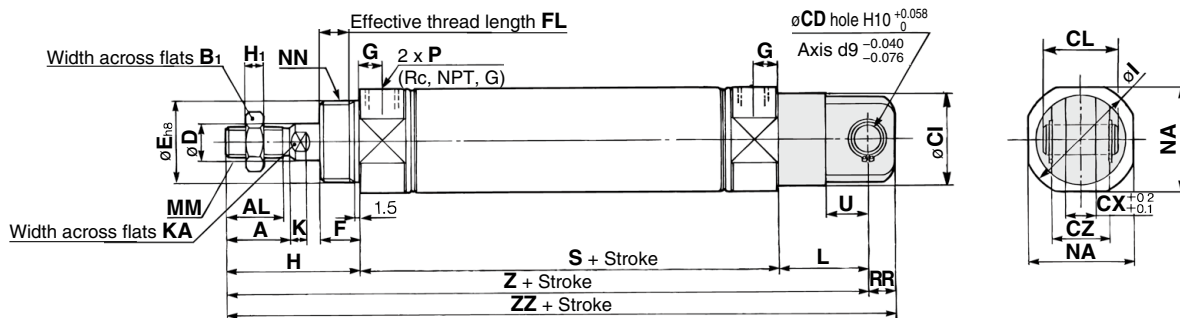

With air cushion

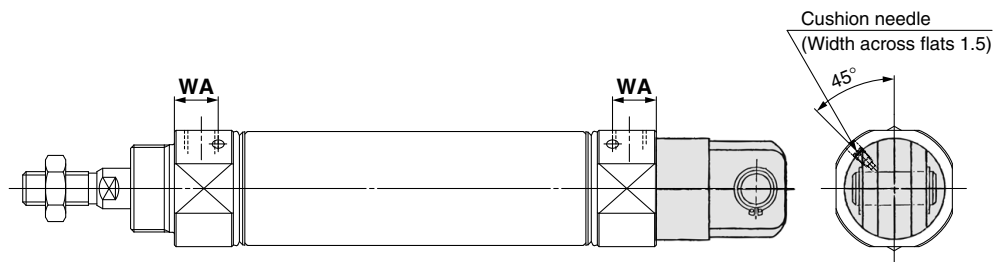

Female rod end

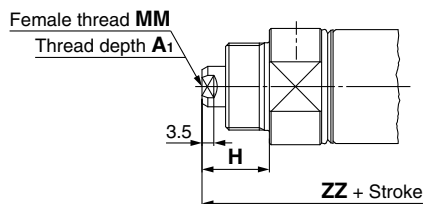

Bore size	A	AL	B ₁	CD	CI	CL	CX	CZ	D	E	F	FL	G	H	H ₁	I	K	KA	L	MM	NA	NN	P	RR	S	U	Z	ZZ
20	18	15.5	13	9	24	25	10	19	8	20 ⁰ _{-0.033}	13	10.5	8	41	5	28	5	6	30	M8 x 1.25	24	M20 x 1.5	1/8	9	62	14	133	142
25	22	19.5	17	9	30	25	10	19	10	26 ⁰ _{-0.033}	13	10.5	8	45	6	33.5	5.5	8	30	M10 x 1.25	30	M26 x 1.5	1/8	9	62	14	137	146
32	22	19.5	17	9	30	25	10	19	12	26 ⁰ _{-0.033}	13	10.5	8	45	6	37.5	5.5	10	30	M10 x 1.25	34.5	M26 x 1.5	1/8	9	64	14	139	148
40	24	21	22	10	38	41.2	15	30	14	32 ⁰ _{-0.039}	16	13.5	11	50	8	46.5	7	12	39	M14 x 1.5	42.5	M32 x 2	1/4	11	88	18	177	188

* A clevis pin and retaining rings (split pins for $\phi 40$) are shipped together with the product.

With Air Cushion [mm]

Bore size	WA
20	12
25	12
32	11
40	16

Female Rod End [mm]

Bore size	A ₁	H	MM	ZZ
20	8	20	M4 x 0.7	121
25	8	20	M5 x 0.8	121
32	12	20	M6 x 1	123
40	13	21	M8 x 1.25	159

* When a female thread is used, use a thin wrench when tightening the piston rod.

* When a female thread is used, depending on the material of the workpiece, use a washer etc., to prevent the contact part at the rod end from being deformed.

Rod Trunnion (U)

CM2U Bore size — Stroke Z1

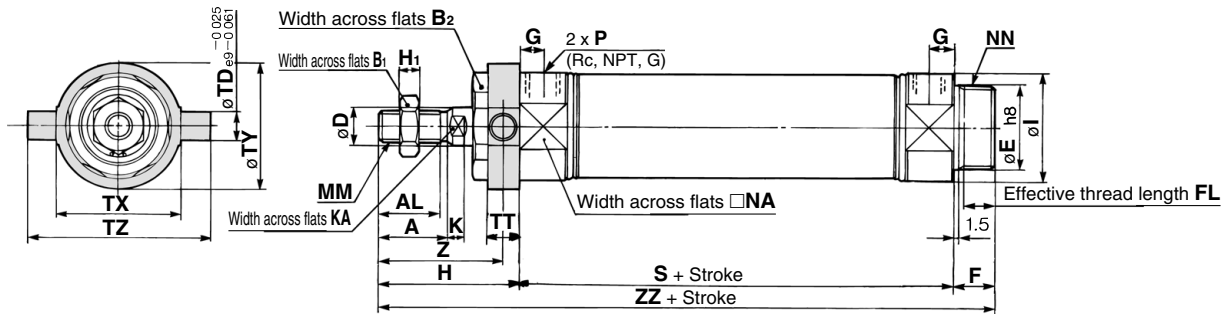

Boss-cut

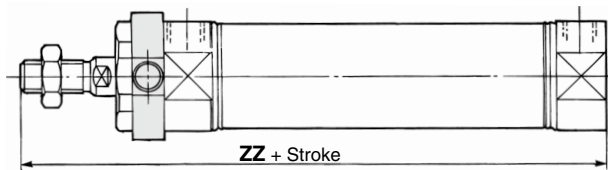

With air cushion

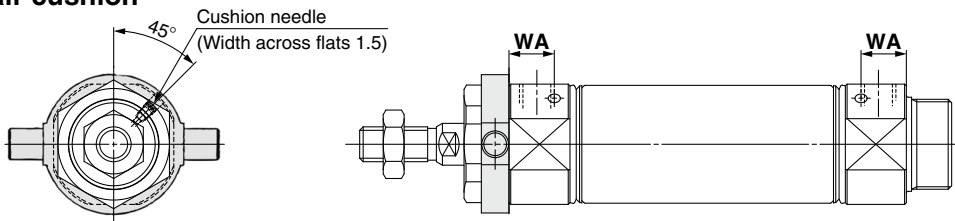

Female rod end

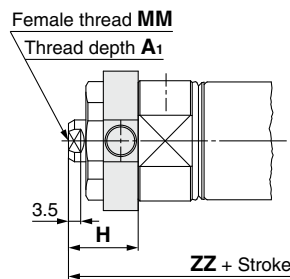

Bore size	A	AL	B ₁	B ₂	D	E	F	FL	G	H	H ₁	I	K	KA	MM	NA	NN	P
20	18	15.5	13	26	8	20 ⁰ _{-0.033}	13	10.5	8	41	5	28	5	6	M8 x 1.25	24	M20 x 1.5	1/8
25	22	19.5	17	32	10	26 ⁰ _{-0.033}	13	10.5	8	45	6	33.5	5.5	8	M10 x 1.25	30	M26 x 1.5	1/8
32	22	19.5	17	32	12	26 ⁰ _{-0.033}	13	10.5	8	45	6	37.5	5.5	10	M10 x 1.25	34.5	M26 x 1.5	1/8
40	24	21	22	41	14	32 ⁰ _{-0.039}	16	13.5	11	50	8	46.5	7	12	M14 x 1.5	42.5	M32 x 2	1/4

Bore size	S	TD	TT	TX	TY	TZ	Z	ZZ
20	62	8	10	32	32	52	36	116
25	62	9	10	40	40	60	40	120
32	64	9	10	40	40	60	40	122
40	88	10	11	53	53	77	44.5	154

Bore size	ZZ
20	103
25	107
32	109
40	138

Bore size	WA
20	12
25	12
32	11
40	16

Bore size	A ₁	H	MM	ZZ
20	8	20	M4 x 0.7	95
25	8	20	M5 x 0.8	95
32	12	20	M6 x 1	97
40	13	21	M8 x 1.25	125

- * When a female thread is used, use a thin wrench when tightening the piston rod.
- * When a female thread is used, depending on the material of the workpiece, use a washer etc., to prevent the contact part at the rod end from being deformed.

* The bracket is shipped together with the product.

CM2 Series

Head Trunnion (T)

CM2T Bore size — Stroke Z1

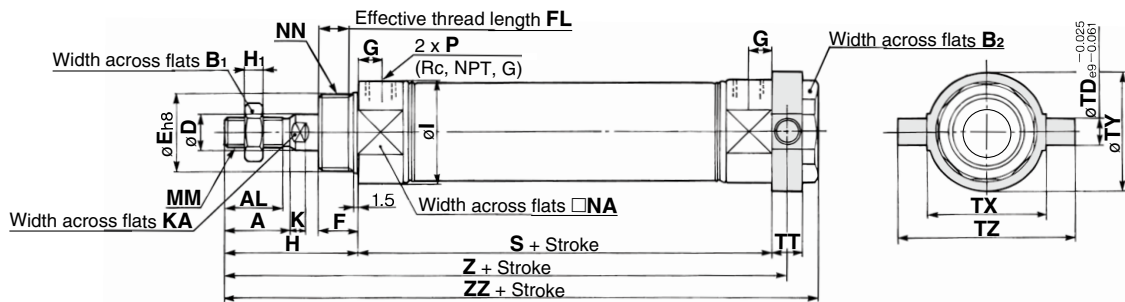

With air cushion

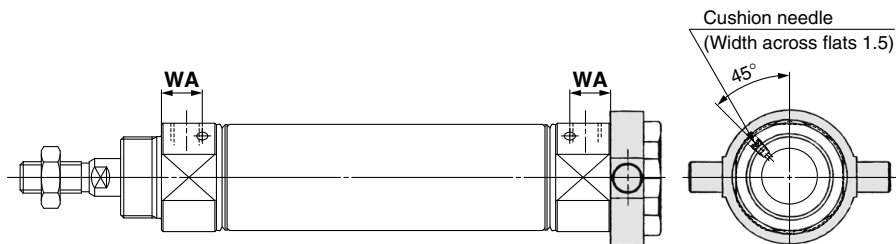

Female rod end

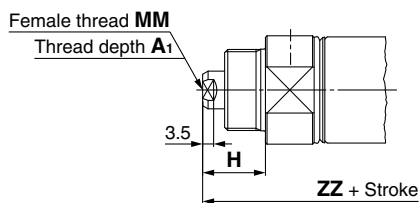

Bore size	A	AL	B ₁	B ₂	D	E	F	FL	G	H	H ₁	I	K	KA	MM	NA	NN	P
20	18	15.5	13	26	8	20 ⁰ _{-0.033}	13	10.5	8	41	5	28	5	6	M8 x 1.25	24	M20 x 1.5	1/8
25	22	19.5	17	32	10	26 ⁰ _{-0.033}	13	10.5	8	45	6	33.5	5.5	8	M10 x 1.25	30	M26 x 1.5	1/8
32	22	19.5	17	32	12	26 ⁰ _{-0.033}	13	10.5	8	45	6	37.5	5.5	10	M10 x 1.25	34.5	M26 x 1.5	1/8
40	24	21	22	41	14	32 ⁰ _{-0.039}	16	13.5	11	50	8	46.5	7	12	M14 x 1.5	42.5	M32 x 2	1/4

Bore size	S	TD	TT	TX	TY	TZ	Z	ZZ
20	62	8	10	32	32	52	108	118
25	62	9	10	40	40	60	112	122
32	64	9	10	40	40	60	114	124
40	88	10	11	53	53	77	143.5	154

* The bracket is shipped together with the product.

With Air Cushion [mm]

Bore size	WA
20	12
25	12
32	11
40	16

Female Rod End [mm]

Bore size	A ₁	H	MM	ZZ
20	8	20	M4 x 0.7	97
25	8	20	M5 x 0.8	97
32	12	20	M6 x 1	99
40	13	21	M8 x 1.25	125

* When a female thread is used, use a thin wrench when tightening the piston rod.

* When a female thread is used, depending on the material of the workpiece, use a washer etc., to prevent the contact part at the rod end from being deformed.

Integrated Clevis (E)

CM2E Bore size — Stroke Z1

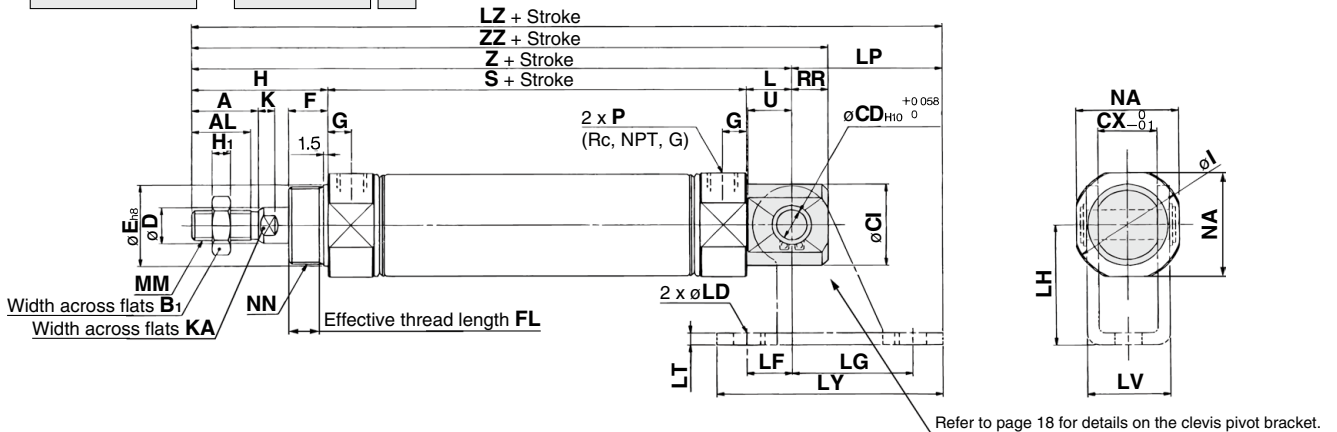

With air cushion

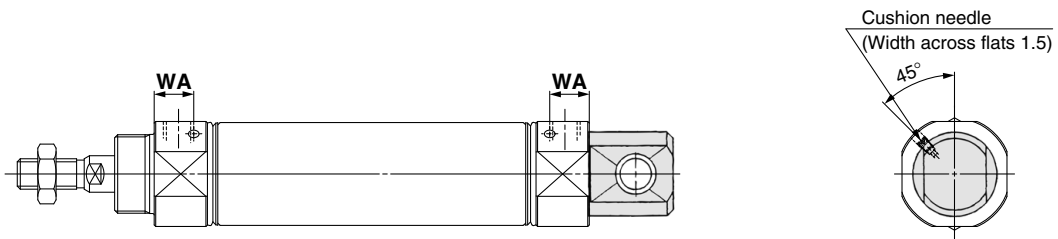

Integrated clevis (90°)(V)

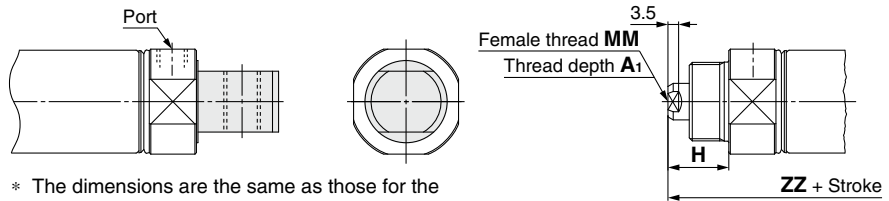

* The dimensions are the same as those for the integrated clevis (E).

Bore size	A	AL	B ₁	CD	CI	CX	D	E	F	FL	G	H	H ₁	I	K	KA	L	MM	NA	NN
20	18	15.5	13	8	20	12	8	20 ⁰ _{-0.033}	13	10.5	8	41	5	28	5	6	12	M8 x 1.25	24	M20 x 1.5
25	22	19.5	17	8	22	12	10	26 ⁰ _{-0.033}	13	10.5	8	45	6	33.5	5.5	8	12	M10 x 1.25	30	M26 x 1.5
32	22	19.5	17	10	27	20	12	26 ⁰ _{-0.033}	13	10.5	8	45	6	37.5	5.5	10	15	M10 x 1.25	34.5	M26 x 1.5
40	24	21	22	10	33	20	14	32 ⁰ _{-0.039}	16	13.5	11	50	8	46.5	7	12	15	M14 x 1.5	42.5	M32 x 2

Bore size	P	RR	S	U	Z	ZZ
20	1/8	9	62	11.5	115	124
25	1/8	9	62	11.5	119	128
32	1/8	12	64	14.5	124	136
40	1/4	12	88	14.5	153	165

With Air Cushion [mm]	
Bore size	WA
20	12
25	12
32	11
40	16

Female Rod End [mm]				
Bore size	A ₁	H	MM	ZZ
20	8	20	M4 x 0.7	103
25	8	20	M5 x 0.8	103
32	12	20	M6 x 1	111
40	13	21	M8 x 1.25	136

Clevis Pivot Bracket [mm]									
Bore size	LD	LF	LG	LH	LP	LT	LV	LY	LZ
20	6.8	15	30	30	37	3.2	18.4	59	152
25	6.8	15	30	30	37	3.2	18.4	59	156
32	9	15	40	40	50	4	28	75	174
40	9	15	40	40	50	4	28	75	203

* When a female thread is used, use a thin wrench when tightening the piston rod.
* When a female thread is used, depending on the material of the workpiece, use a washer etc., to prevent the contact part at the rod end from being deformed.

CM2 Series Dimensions of Accessories

With Single Knuckle Joint

[mm]

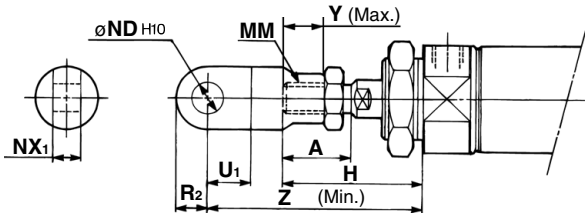

Bore size	A	H	MM	ND _{H10}	NX ₁	U ₁	R ₂	Y	Z
20	18	41	M8 x 1.25	9 ^{+0.058} ₀	9 ^{-0.1} _{-0.2}	14	10	11	66
25, 32	22	45	M10 x 1.25	9 ^{+0.058} ₀	9 ^{-0.1} _{-0.2}	14	10	14	69
40	24	50	M14 x 1.5	12 ^{+0.070} ₀	16 ^{-0.1} _{-0.3}	20	14	13	92

Single Knuckle Joint

[mm]

I-020B, 032B

I-040B

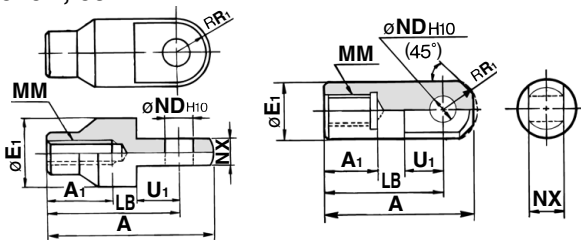

Part no.	Material	Applicable bore size	A	A ₁	E ₁	LB	MM	ND _{H10}	NX	R ₁	U ₁
I-020B	Carbon steel	20	46	16	20	36	M8 x 1.25	9 ^{+0.058} ₀	9 ^{-0.1} _{-0.2}	10	14
I-020BSUS	Stainless steel										
I-032B	Carbon steel	25, 32	48	18	20	38	M10 x 1.25	9 ^{+0.058} ₀	9 ^{-0.1} _{-0.2}	10	14
I-032BSUS	Stainless steel										
I-040B	Carbon steel	40	69	22	24	55	M14 x 1.5	12 ^{+0.070} ₀	16 ^{-0.1} _{-0.3}	15.5	20
I-040BSUS	Stainless steel										

With Double Knuckle Joint

[mm]

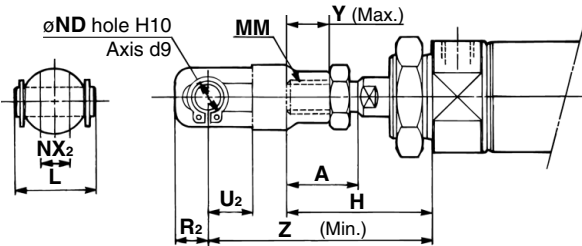

Bore size	A	H	L	MM	ND	NX ₂	R ₂	U ₂	Y	Z
20	18	41	25	M8 x 1.25	9	9 ^{+0.2} _{+0.1}	10	14	11	66
25, 32	22	45	25	M10 x 1.25	9	9 ^{+0.2} _{+0.1}	10	14	14	69
40	24	50	49.7	M14 x 1.5	12	16 ^{+0.3} _{+0.1}	13	25	13	92

Double Knuckle Joint

[mm]

Y-020B, Y-032B

Y-040B

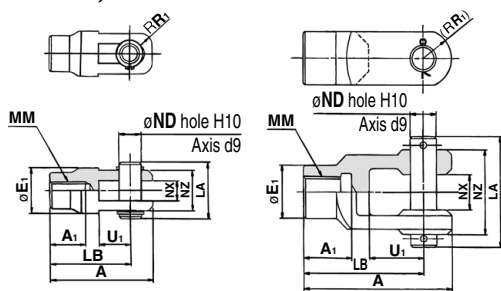

Part no.	Material	Applicable bore size	A	A ₁	E ₁	LA	LB	MM	ND	NX	NZ	R ₁	U ₁	Included pin part no.	Retaining ring, Split pin size
Y-020B	Carbon steel	20	46	16	20	25	36	M8 x 1.25	9	9 ^{+0.2} _{+0.1}	18	5	14	CDP-1-XC27	Type C9 for axis
Y-020BSUS	Stainless steel														
Y-032B	Carbon steel	25, 32	48	18	20	25	38	M10 x 1.25	9	9 ^{+0.2} _{+0.1}	18	5	14	CDP-1-XC27	Type C9 for axis
Y-032BSUS	Stainless steel														
Y-040B	Carbon steel	40	68	22	24	49.7	55	M14 x 1.5	12	16 ^{+0.3} _{+0.1}	38	13	25	CDP-3	ø3 x 18 L
Y-040BSUS	Stainless steel														

* A knuckle pin and retaining rings (split pins for ø40) are included.

Rod End

KJ□D

Material:
Carbon steel

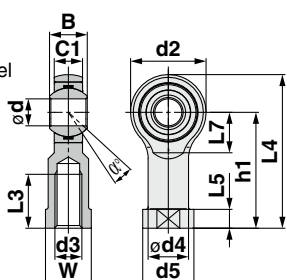

Model	Applicable bore size	d _{H7}	d ₃	B ^{-0.12}	C1	d ₂	d ₄	d ₅	h ₁	L _{3min}	L ₄	L ₅	L ₇	W	α°	Allowable radial static load [kN]	Weight [kg]
KJ8D	20	8	M8 x 1.25	12	9	24	12.5	16	36	16	48	5	13	14	14	12	0.05
KJ10D	25, 32	10	M10 x 1.25	14	10.5	28	15	19	43	20	57	6.5	15	17	13	14	0.07
KJ14D	40	14	M14 x 1.5	19	13.5	36	20	25	57	25	75	8	19	22	15	36	0.16

The allowable radial load shows the allowable value of a single rod end. When the rod end is used for connecting to a cylinder, the allowable radial load conforms to the cylinder specifications.

* Refer to the **Web Catalog** for specifications and precautions.

Double Clevis Pin

[mm]

Bore size: $\varnothing 20, \varnothing 25, \varnothing 32$

CDP-1: Carbon steel

CDP-1-XC27: Stainless steel

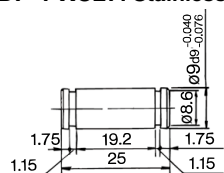

Retaining ring: Type C9 for axis

Bore size: $\varnothing 40$

CDP-2: Carbon steel

CDP-2-XC27: Stainless steel

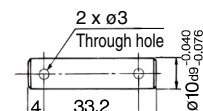

Split pin: $\varnothing 3 \times 18$ L

* Retaining rings (split pins for $\varnothing 40$) are included.

Double Knuckle Pin

[mm]

Bore size: $\varnothing 20, \varnothing 25, \varnothing 32$

CDP-1: Carbon steel

CDP-1-XC27: Stainless steel

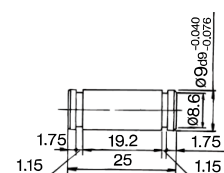

Retaining ring: Type C9 for axis

Bore size: $\varnothing 40$

CDP-3: Carbon steel

CDP-3-XC27: Stainless steel

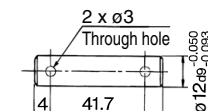

Split pin: $\varnothing 3 \times 18$ L

* Retaining rings (split pins for $\varnothing 40$) are included.

Rod End Nut /Material: Carbon steel, Stainless steel

[mm]

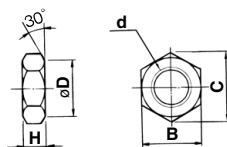

Part no.	Material	Applicable bore size	B	C	D	d	H
NT-02	Carbon steel	20	13	15	12.5	M8 x 1.25	5
NT-02SUS	Stainless steel						
NT-03	Carbon steel	25, 32	17	19.6	16.5	M10 x 1.25	6
NT-03SUS	Stainless steel						
NT-04	Carbon steel	40	22	25.4	21	M14 x 1.5	8
NT-04SUS	Stainless steel						

Mounting Nut /Material: Carbon steel, Stainless steel

[mm]

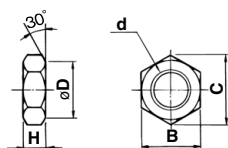

Part no.	Material	Applicable bore size	B	C	D	d	H
SN-020B	Carbon steel	20	26	30	25.5	M20 x 1.5	8
SN-020BSUS	Stainless steel						
SN-032B	Carbon steel	25, 32	32	37	31.5	M26 x 1.5	8
SN-032BSUS	Stainless steel						
SN-040B	Carbon steel	40	41	47.3	40.5	M32 x 2.0	10
SN-040BSUS	Stainless steel						

Clevis Pivot Bracket (For CM2E(V)) /Material: Carbon steel

[mm]

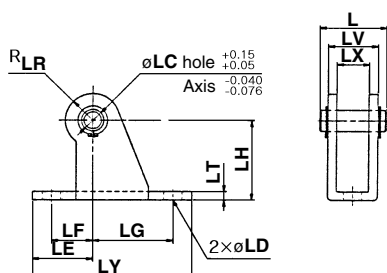

Part no.	Material	Applicable bore size	L	LC	LD	LE	LF	LG	LH	LR
CM-E020B	Carbon steel	20, 25	24.5	8	6.8	22	15	30	30	10
CM-E032B	Carbon steel	32, 40	34	10	9	25	15	40	40	13

Part no.	Material	Applicable bore size	LT	LX	LY	LV	Included pin part no.
CM-E020B	Carbon steel	20, 25	3.2	12	59	18.4	CD-S02
CM-E032B	Carbon steel	32, 40	4	20	75	28	CD-S03

* A clevis pivot bracket pin and retaining rings are included.

* It cannot be used for the single clevis (CM2C) and the double clevis (CM2D).

CM2 Series

Trunnion Nut /Material: Carbon steel

[mm]

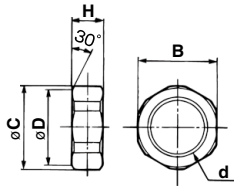

Part no.	Applicable bore size	B	C	D	d	H
TN-020B	20	26	28	25.5	M20 x 1.5	10
TN-032B	25, 32	32	34	31.5	M26 x 1.5	10
TN-040B	40	41	45	40.5	M32 x 2	10

Clevis Pivot Bracket Pin (For CM2E(V)) /Material: Carbon steel

[mm]

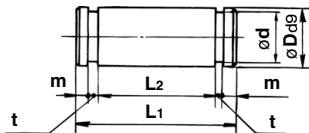

Part no.	Material	Applicable bore size	Dø	d	L1	L2	m	t	Included retaining ring
CD-S02	Carbon steel	20, 25	8 ^{-0.040} _{-0.076}	7.6	24.5	19.5	1.6	0.9	Type C8 for axis
CD-S03	Carbon steel	32, 40	10 ^{-0.040} _{-0.076}	9.6	34	29	1.35	1.15	Type C10 for axis

* Retaining rings are included.

Mounting Brackets, Rod End Brackets, and Nut Material: Stainless Steel

Part Nos. (Dimensions: Same as those of the standard type)

Bore size [mm]	Foot	Flange	Single knuckle joint	Double knuckle joint*1	Mounting nut	Rod end nut
20	CM-L020B-XB12	CM-F020BSUS	I-020BSUS	Y-020BSUS	SN-020BSUS	NT-02SUS
25, 32	CM-L032B-XB12	CM-F032BSUS	I-032BSUS	Y-032BSUS	SN-032BSUS	NT-03SUS
40	CM-L040B-XB12	CM-F040BSUS	I-040BSUS	Y-040BSUS	SN-040BSUS	NT-04SUS

*1 A knuckle pin and retaining rings are shipped together with the product. Refer to the XC27 for details on stainless steel double clevis pins and double knuckle pins (**Web Catalog**). The accessories need to be ordered separately from the cylinder.

With Single Clevis

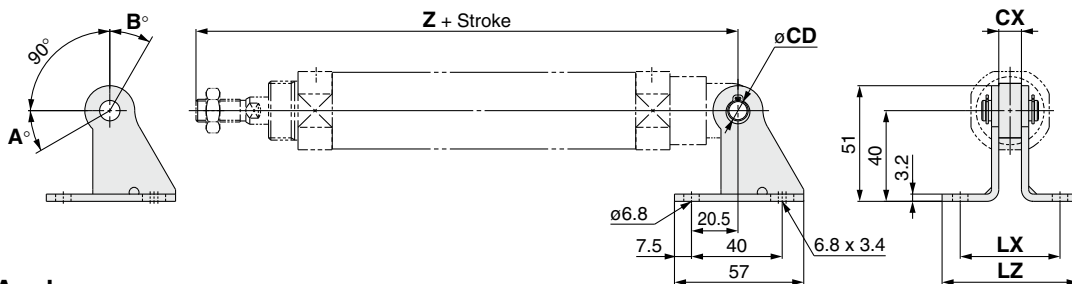

Rotation Angle

Bore size [mm]	A°	B°	A° + B° + 90°
20	25	85	200
25, 32	21	81	192
40	26	86	202

Mounting	Part no.	Applicable bore size	CX	Z + Stroke	CD	LX	LZ
CM2C (Single clevis)	CM-B032	20	10	133	9	44	60
		25		137			
		32		139			
	CM-B040	40	15	177	10	49	65

* A pivot bracket pin and retaining rings are not included with the pivot bracket.

With Rod Trunnion

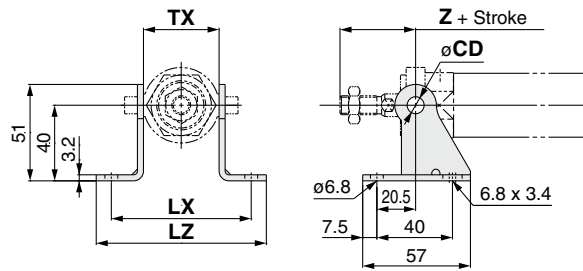

With Head Trunnion

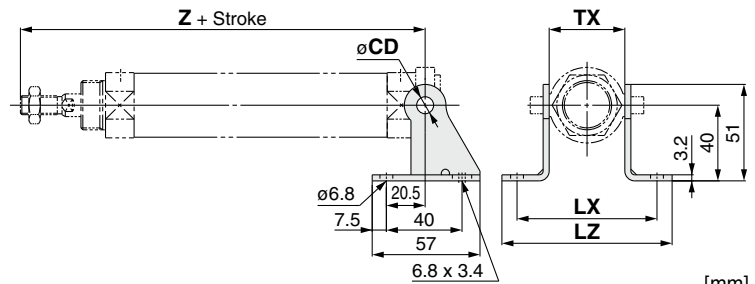

Mounting	Part no.	Applicable bore size	TX	Rod trunnion	Head trunnion	CD	LX	LZ
				Z + Stroke	Z + Stroke			
CM2U/CM2T (Rod/Head trunnion)	CM-B020	20	32	36	108	8	66	82
	CM-B032	25	40	40	112	9	74	90
		32			114			
CM-B040	40	53	44.5	143.5	10	87	103	

* A pivot bracket pin and retaining rings are not included with the pivot bracket.

Pivot Bracket /Material: Carbon steel

* Pivot brackets consists of a set of two brackets.

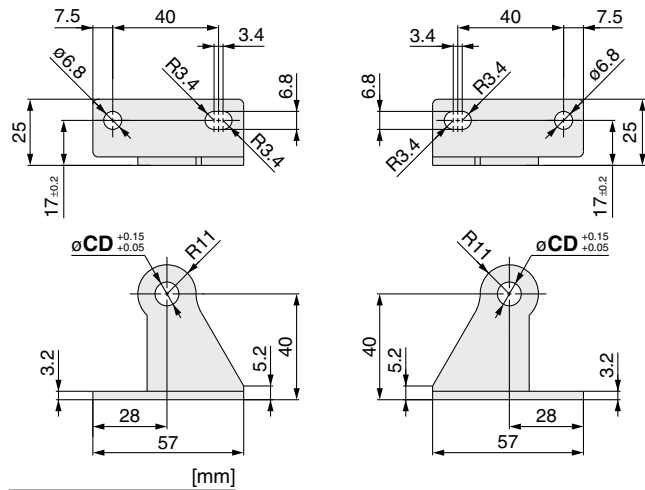

Part no.	CD
CM-B020*1	8
CM-B032	9
CM-B040	10

*1 Only for the trunnion

* A pivot bracket pin and retaining rings are not included with the pivot bracket.

Pivot Bracket Pin (For CM2C) /Material: Carbon steel

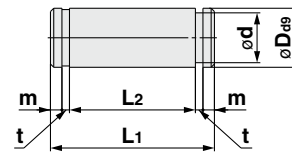

Applicable bore size	Part no.	Dd9	d	L1	L2	m	t	Included retaining ring
20 to 32	CDP-1	9 ^{+0.040} _{-0.076}	8.6	25	19.2	1.75	1.15	Type C 9 for axis
40	CD-S03	10 ^{+0.040} _{-0.076}	9.6	34	29	1.35	1.15	Type C 10 for axis

* Retaining rings are included with the pivot bracket pin.

CM2 Series Auto Switch Mounting

Auto Switch Proper Mounting Position (Detection at stroke end) and Mounting Height

Solid state auto switch

D-M9□
D-M9□E
D-M9□W
D-M9□A

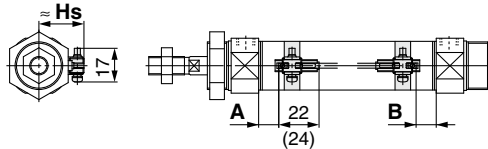

(): Dimension of the D-M9□A
A and B are the dimensions from the end of the head cover/rod cover to the end of the auto switch.

D-M9□V
D-M9□EV
D-M9□WV
D-M9□AV

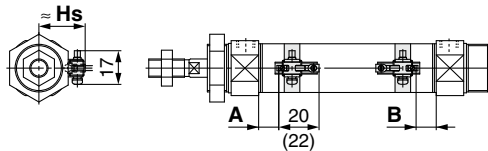

(): Dimension of the D-M9□AV
A and B are the dimensions from the end of the head cover/rod cover to the end of the auto switch.

D-H7□/H7□W/H7NF/H7BA/H7C

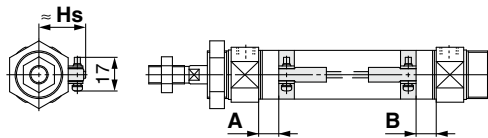

D-G5NT

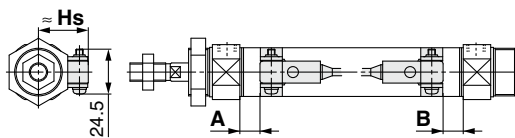

D-G39A/K39A

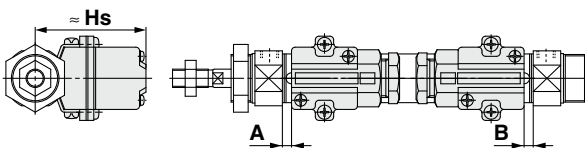

Reed auto switch

D-A9□

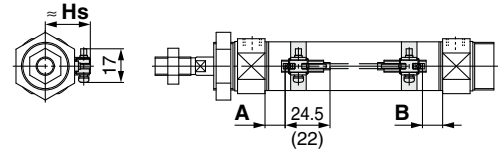

(): Dimension of the D-A96
A and B are the dimensions from the end of the head cover/rod cover to the end of the auto switch.

D-A9□V

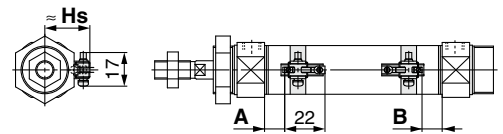

A and B are the dimensions from the end of the head cover/rod cover to the end of the auto switch.

D-C7/C8/C73C/C80C

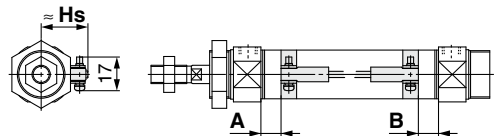

D-B5/B6/B59W

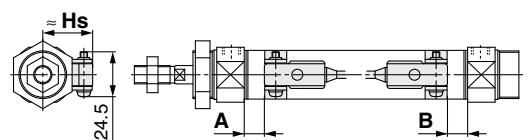

D-A33A/A34A

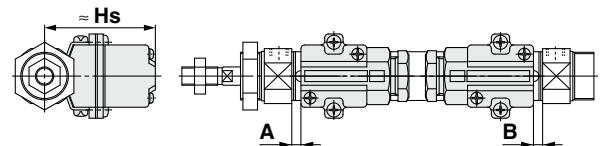

D-A44A

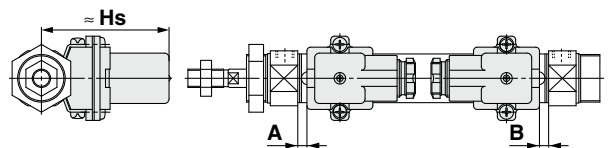

Auto Switch Proper Mounting Position (Detection at stroke end) and Mounting Height

Auto Switch Proper Mounting Position

[mm]

Auto switch model	D-M9□(V) D-M9□E(V) D-M9□W(V) D-M9□A(V)		D-A9□(V)		D-G39A D-K39A D-A3□A D-A44A		D-H7□ D-H7C D-H7□W D-H7BA D-H7NF		D-G5NT		D-C7□/C80 D-C73C D-C80C		D-B5□ D-B64		D-B59W	
	A	B	A	B	A	B	A	B	A	B	A	B	A	B	A	B
20	11	9.5	7	5.5	1	0	6.5	5	3	1.5	7.5	6	1.5	0	4	3
25	10	10	6	6	0	0	5.5	5.5	2	2	6.5	6.5	0.5	0.5	3.5	3.5
32	11.5	10.5	7.5	6.5	1.5	0.5	7	6	3.5	2.5	8	7	2	1	5	4
40	17.5	15.5	13.5	11.5	7.5	5.5	13	11	9.5	7.5	14	12	8	6	11	9

* Adjust the auto switch after confirming the operating conditions in the actual setting.

Auto Switch Mounting Height

[mm]

Auto switch model	D-A9□(V) D-M9□E(V) D-M9□(V) D-M9□W(V) D-M9□A(V) D-H7□ D-H7□W D-H7BA D-H7NF D-C7□ D-C80		D-B5□ D-B64 D-B59W D-G5NT D-H7C		D-C73C D-C80C		D-G39A D-K39A D-A3□A		D-A44A	
	Hs	Hs	Hs	Hs	Hs	Hs				
20	24.5	25.5	25	60	69.5					
25	27	28	27.5	62.5	72					
32	30.5	31.5	31	66	75.5					
40	34.5	35.5	35	70	79.5					

Minimum Stroke for Auto Switch Mounting

n: Number of auto switches [mm]

Auto switch model	Number of auto switches				
	With 1 pc.	With 2 pcs.		With n pcs.	
		Different surfaces	Same surface	Different surfaces	Same surface
D-M9□ D-M9□E	5	15*1	40*1	$20 + 35 \frac{(n-2)}{2}$ (n = 2, 4, 6...)*3	$55 + 35 (n - 2)$ (n = 2, 3, 4, 5...)
D-M9□W	10	15*1	40*1	$20 + 35 \frac{(n-2)}{2}$ (n = 2, 4, 6...)*3	$55 + 35 (n - 2)$ (n = 2, 3, 4, 5...)
D-M9□A	10	15*1	40*1	$25 + 35 \frac{(n-2)}{2}$ (n = 2, 4, 6...)*3	$60 + 35 (n - 2)$ (n = 2, 3, 4, 5...)
D-A9□	5	15	30*1	$15 + 35 \frac{(n-2)}{2}$ (n = 2, 4, 6...)*3	$50 + 35 (n - 2)$ (n = 2, 3, 4, 5...)
D-M9□V D-M9□EV	5	15*1	35	$20 + 35 \frac{(n-2)}{2}$ (n = 2, 4, 6...)*3	$35 + 35 (n - 2)$ (n = 2, 3, 4, 5...)
D-A9□V	5	15	25	$15 + 35 \frac{(n-2)}{2}$ (n = 2, 4, 6...)*3	$25 + 35 (n - 2)$ (n = 2, 3, 4, 5...)
D-M9□WV D-M9□AV	10	15*1	35	$20 + 35 \frac{(n-2)}{2}$ (n = 2, 4, 6...)*3	$35 + 35 (n - 2)$ (n = 2, 3, 4, 5...)
D-C7□ D-C80	10	15	50	$15 + 45 \frac{(n-2)}{2}$ (n = 2, 4, 6...)*3	$50 + 45 (n - 2)$ (n = 2, 3, 4, 5...)
D-H7□ D-H7□W D-H7BA D-H7NF	10	15	60	$15 + 45 \frac{(n-2)}{2}$ (n = 2, 4, 6...)*3	$60 + 45 (n - 2)$ (n = 2, 3, 4, 5...)
D-H7C D-C73C D-C80C	10	15	65	$15 + 50 \frac{(n-2)}{2}$ (n = 2, 4, 6...)*3	$65 + 50 (n - 2)$ (n = 2, 3, 4, 5...)
D-G5NT D-B5□/B64	10	15	75	$15 + 50 \frac{(n-2)}{2}$ (n = 2, 4, 6...)*3	$75 + 55 (n - 2)$ (n = 2, 3, 4, 5...)
D-B59W	15	20	75	$20 + 50 \frac{(n-2)}{2}$ (n = 2, 4, 6...)*3	$75 + 55 (n - 2)$ (n = 2, 3, 4, 5...)
D-G39A D-K39A D-A3□A D-A44A	10	35	100	$35 + 30 (n - 2)$ (n = 2, 3, 4, 5...)	$100 + 100 (n - 2)$ (n = 2, 3, 4, 5...)

*3 When "n" is an odd number, an even number that is one larger than the odd number is to be used for the calculation.

*1 Auto switch mounting

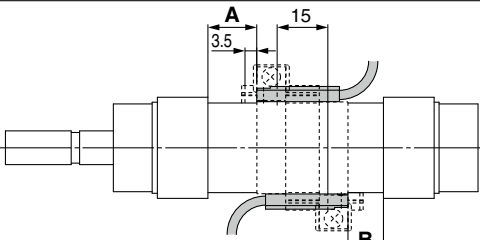
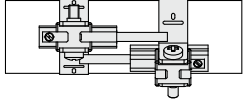
Auto switch model	With 2 auto switches	
	Different surfaces	Same surface
	 <p>Correct auto switch mounting position is 3.5 mm from the back face of the switch holder.</p>	 <p>The auto switch is mounted by slightly displacing it in a direction (cylinder tube circumferential exterior) so that the auto switch and lead wire do not interfere with each other.</p>
D-M9□(V) D-M9□E(V) D-M9□W(V)	15 to 20 mm stroke*2	40 to 55 mm stroke*2
D-M9□A(V)	15 to 25 mm stroke*2	40 to 60 mm stroke*2
D-A9□(V)	—	30 to 50 mm stroke*2

*2 Minimum stroke for auto switch mounting in types other than those mentioned in *1

Operating Range

Auto switch model	Bore size [mm]			
	20	25	32	40
D-A9□(V)	6	6	6	6
D-M9□(V) D-M9□E(V) D-M9□W(V) D-M9□A(V)	3	3	4	3.5
D-C7□/C80 D-C73C/C80C	7	8	8	8
D-B5□/B64 D-A3□A/A44A	8	8	9	9
D-B59W	12	12	13	13
D-H7□/H7□W/H7BA D-G5NT/H7NF	4	4	4.5	5
D-H7C	7	8.5	9	10
D-G39A/K39A	8	9	9	9

* Values which include hysteresis are for reference purposes only. They are not a guarantee (assuming approximately ±30% dispersion) and may change substantially depending on the ambient environment.

Auto Switch Mounting Brackets/Part Nos.

Auto switch model	Bore size [mm]			
	ø20	ø25	ø32	ø40
D-M9□(V) D-M9□E(V) D-M9□W(V) D-A9□(V)	*1 BM5-020 (A set of a, b, c, d)	*1 BM5-025 (A set of a, b, c, d)	*1 BM5-032 (A set of a, b, c, d)	*1 BM5-040 (A set of a, b, c, d)
D-M9□A(V)*2	BM5-020S (A set of b, c, e, f)	BM5-025S (A set of b, c, e, f)	BM5-032S (A set of b, c, e, f)	BM5-040S (A set of b, c, e, f)

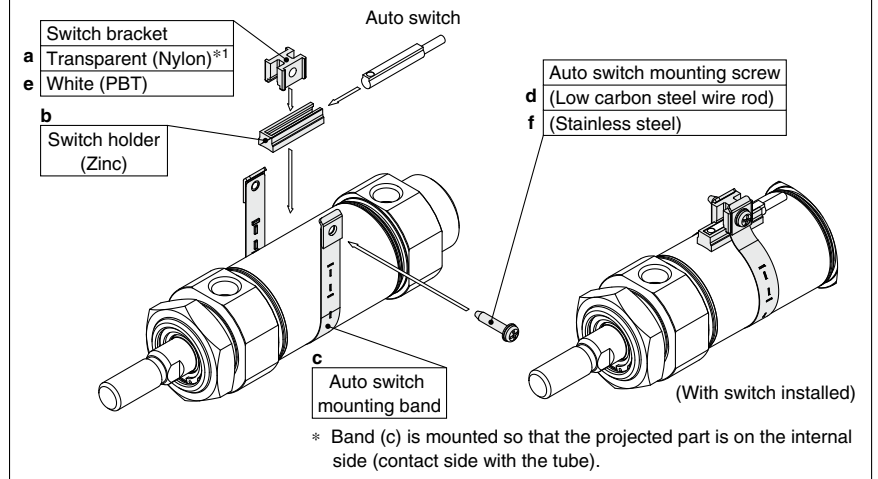

D-H7□ D-H7□W D-H7NF D-C7□/C80 D-C73C/C80C	BM2-020A (A set of c and d)	BM2-025A (A set of c and d)	BM2-032A (A set of c and d)	BM2-040A (A set of c and d)
D-H7BA	BM2-020AS (A set of c and f)	BM2-025AS (A set of c and f)	BM2-032AS (A set of c and f)	BM2-040AS (A set of c and f)
D-B5□/B64 D-B59W D-G5NT	BA2-020 (A set of c and d)	BA2-025 (A set of c and d)	BA2-032 (A set of c and d)	BA2-040 (A set of c and d)
D-A3□A/A44A D-G39A/K39A	BM3-020 (A set of c and d)	BM3-025 (A set of c and d)	BM3-032 (A set of c and d)	BM3-040 (A set of c and d)

*1 Since the switch bracket (made of nylon) is affected in an environment where alcohol, chloroform, methylamines, hydrochloric acid, or sulfuric acid is splashed over, so it cannot be used. Please contact SMC regarding other chemicals.

*2 When mounting a D-M9□A(V) type auto switch, if the switch bracket is mounted on the indicator light, it may damage the auto switch. Therefore, be sure to avoid mounting the switch bracket on the indicator light.

Band Mounting Brackets Set Part Nos.

Set part no.	Contents
BJ4-1	· Switch bracket (White/PBT) (e) · Switch holder (b)
BJ5-1	· Switch bracket (Transparent/Nylon) (a) · Switch holder (b)

Other than the applicable auto switches listed in "How to Order," the following auto switches are also mountable.

Refer to the **Web Catalog** for detailed specifications.

Type	Model	Electrical entry	Features
Solid state	D-H7A1, H7A2, H7B	Grommet (In-line)	—
	D-H7NW, H7PW, H7BW		Diagnostic indication (2-color indicator)
	D-H7BA		Water resistant (2-color indicator)
	D-G5NT		With timer
Reed	D-B53, C73, C76	Grommet (In-line)	—
	D-C80		Without indicator light

* With pre-wired connector is also available for solid state auto switches. For details, refer to the **Web Catalog**.

* Normally closed (NC = b contact) solid state auto switches (D-M9□E(V)) are also available. For details, refer to the **Web Catalog**.

Prior to Use

Auto Switch Connections and Examples

Sink Input Specifications

3-wire, NPN

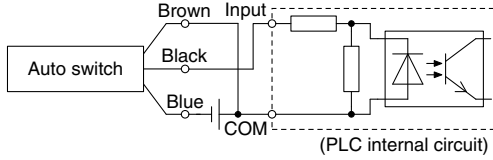

2-wire

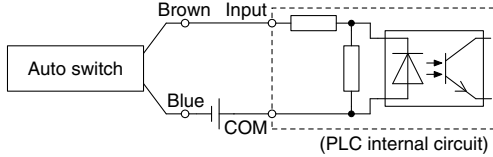

Source Input Specifications

3-wire, PNP

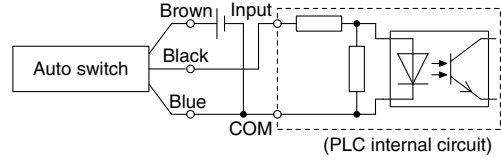

2-wire

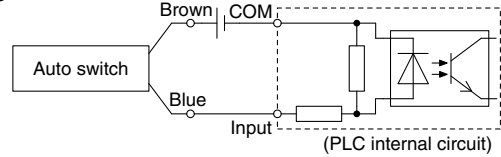

Connect according to the applicable PLC input specifications, as the connection method will vary depending on the PLC input specifications.

Examples of AND (Series) and OR (Parallel) Connections

* When using solid state auto switches, ensure the application is set up so the signals for the first 50 ms are invalid. Depending on the operating environment, the product may not operate properly.

3-wire AND connection for NPN output (Using relays)

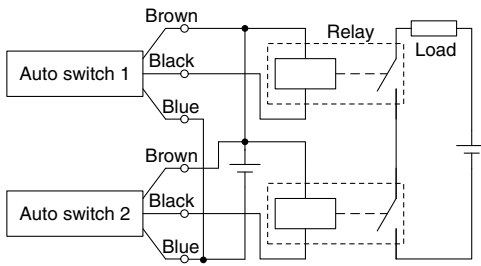

(Performed with auto switches only)

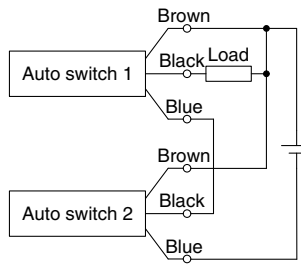

3-wire OR connection for NPN output

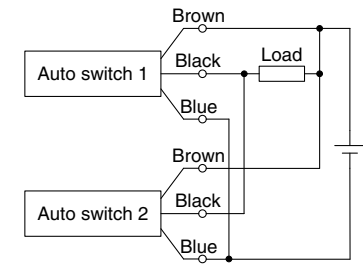

3-wire AND connection for PNP output (Using relays)

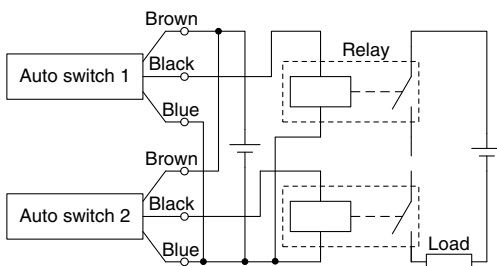

(Performed with auto switches only)

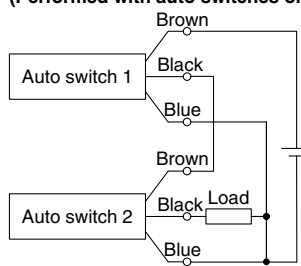

3-wire OR connection for PNP output

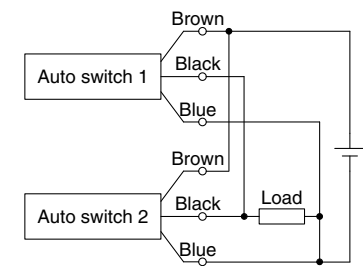

2-wire AND connection

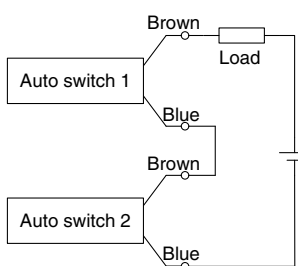

When two auto switches are connected in series, a load may malfunction because the load voltage will decline when in the ON state. The indicator lights will light up when both of the auto switches are in the ON state. Auto switches with a load voltage less than 20 V cannot be used. Please contact SMC if using AND connection for a heat-resistant solid state auto switch or a trimmer switch.

Example) Load voltage at ON
 Power supply voltage: 24 VDC
 Internal voltage drop: 4 V
 Load voltage at ON = Power supply voltage –
 Internal voltage drop x 2 pcs.
 = 24 V – 4 V x 2 pcs.
 = 16 V

2-wire OR connection

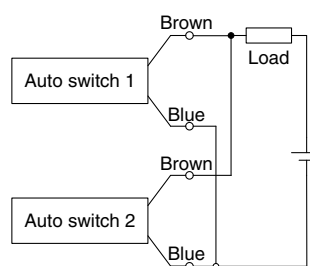

(Solid state)
 When two auto switches are connected in parallel, malfunction may occur because the load voltage will increase when in the OFF state.

(Reed)
 Because there is no current leakage, the load voltage will not increase when turned OFF. However, depending on the number of auto switches in the ON state, the indicator lights may sometimes grow dim or not light up, due to the dispersion and reduction of the current flowing to the auto switches.

Example) Load voltage at OFF
 Leakage current: 1 mA
 Load impedance: 3 kΩ
 Load voltage at OFF = Leakage current x 2 pcs. x
 Load impedance
 = 1 mA x 2 pcs. x 3 kΩ
 = 6 V

CM2 Series

Made to Order Common Specifications

Please contact SMC for detailed dimensions, specifications, and delivery times.



1 Special Port Location

Symbol
-XC3

The locations of the connection port of the rod/head cover and the location of the cushion valve are different than those of the standard type.

Description	Model	Action	Note
Standard	CM2-Z1	Double acting, Single rod	

How to Order

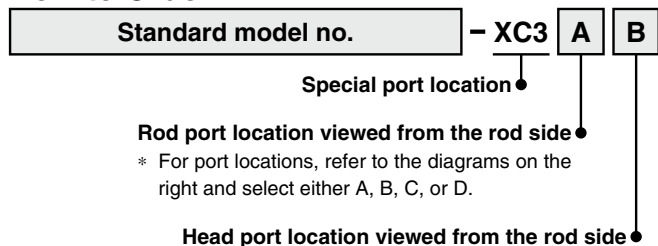

Port Locations

Series	Corresponding symbol of mounting bracket (Positional relationships)
CM2	<p>* Viewed from the rod side, the ports are rendered A, B, C, and D, in the clockwise direction.</p> <p><Positional relationship between clevis and port> * Viewed from the rod side, with the clevis positioned as shown in the diagram, the ports are rendered A, B, C, and D, in the clockwise direction.</p> <p>Positional relationships between port and cushion valve cannot be changed.</p>

Specifications: Same as those of the standard type

2 Made of Stainless Steel

Symbol
-XC6

Suitable for environments where rust and corrosion are likely to be generated

Description	Model	Action	Note
Standard	CM2-Z1	Double acting, Single rod	

Specifications

Material	Stainless steel
Changed parts	XC6A Piston rod Rod end nut
	XC6B Piston rod Rod end nut Retaining ring Mounting nut Bracket (Refer to the mounting brackets in the table on the next page.)
Specifications other than the above and dimensions	Same as those of the standard type

- * The pivot bracket must be ordered separately. (Refer to the mounting brackets in the table on the next page.)
- * Rod end is not affected by this option and should be managed separately.
- * The materials of the cushion needle are the same as standard. It is made from iron and nickel.

How to Order

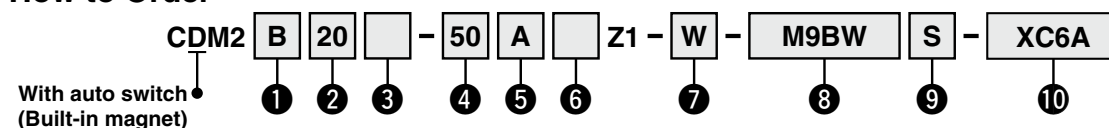

① Mounting

B	Basic (Double-side bossed)
L	Axial foot
F	Rod flange
G	Head flange
C	Single clevis*1
D	Double clevis*1
U	Rod trunnion*1
T	Head trunnion*1
E	Integrated clevis
V	Integrated clevis (90°)
BZ	Boss-cut/Basic
FZ	Boss-cut/Rod flange
UZ	Boss-cut/Rod trunnion*1

*1 Only applicable to the XC6A

② Bore size

20	20 mm
25	25 mm
32	32 mm
40	40 mm

③ Port thread type

Nil	Rc
TN	NPT
TF	G

④ Stroke

Refer to Table 1 for applicable strokes.

⑤ Cushion

Nil	Rubber bumper
A	Air cushion

⑥ Rod end thread

Nil	Male rod end
F	Female rod end

⑦ Rod end bracket

Nil	No bracket
V	Single knuckle joint
W	Double knuckle joint

* No bracket is provided for the female rod end.

⑧ Auto switch

For auto switch models, refer to the table of applicable auto switches.

⑨ Number of auto switches

Nil	2
S	1
n	n

⑩ Made to order

XC6A	Stainless steel rod + Stainless steel end nut
XC6B	Stainless steel rod + Stainless steel end nut + Stainless steel mounting nut + Retaining ring + Bracket

Table 1. Applicable Strokes

Bore size [mm]	Standard stroke [mm]	Max. manufacturable stroke [mm]
20	25, 50, 75, 100, 125, 150, 200, 250, 300	1000
25		
32		
40		

* The manufacturing of intermediate strokes in 1 mm increments is possible.

2 Made of Stainless Steel

Construction

XC6A, XC6B construction

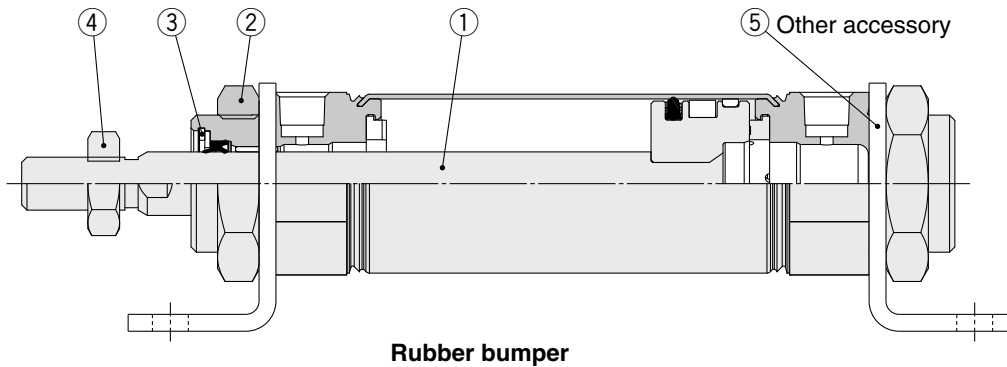

The material of the components below will be changed from standard and those not mentioned will remain the same as standard.

No.	1	2	3	4	5
Description	Piston rod	Mounting nut	Retaining ring	Rod end nut	Bracket (Refer to the mounting brackets below.)
XC6A	Stainless steel	No change (Steel)	No change (Steel)	Stainless steel	No change (Steel)
XC6B	Stainless steel	Stainless steel	Stainless steel	Stainless steel	Stainless steel

Mounting Brackets/Part Nos.

Mounting bracket	Min. order quantity	Bore size [mm]			Contents (for min. order quantity)	
		20	25	32		40
Foot*1	2	CM-L020B-XB12	CM-L032B-XB12		CM-L040B-XB12	2 foot brackets, 1 mounting nut
Foot	1	CM-L020BSUS	CM-L032BSUS	CM-L040BSUS	1 foot bracket*2	
Flange	1	CM-F020BSUS	CM-F032BSUS	CM-F040BSUS	1 flange*2	
Rod end nut	1	NT-02SUS	NT-03SUS	NT-04SUS	1 rod end nut	
Mounting nut	1	SN-020BSUS	SN-032BSUS	SN-040BSUS	1 mounting nut	
Single knuckle joint	1	I-020BSUS	I-032BSUS	I-040BSUS	1 single knuckle joint	
Double knuckle joint	1	Y-020BSUS	Y-032BSUS	Y-040BSUS	1 double knuckle joint, 1 clevis pin, 2 retaining rings (split pins)	

*1 Order two foot brackets per cylinder.

*2 The mounting nut is not included. Order it separately as required.

3 Grease for Food Processing Equipment

Symbol
-XC85

Food grade grease (certified by NSF-H1) is used as lubricant.

Description	Model	Action	Note
Standard	CM2-Z1	Double acting, Single rod	

How to Order

Standard model no. **-XC85**
Grease for food processing equipment

Warning Precautions

Be aware that smoking cigarettes, etc., after your hands have come into contact with the grease used in this cylinder can create a gas that is hazardous to humans.

Not installable zone

Food zone An environment where the raw materials and materials of food products, semi-finished food products, and food products that make direct or indirect contact in a normal processing process

Splash zone An area where a portion of food products accidentally splash and stick under the intended operating conditions. An environment where food products that enter this area do not return to the food product contact portion again, and are not used as food products

Installable zone

Non-food zone ... Other environments including the food splash zone, except for the food contact portions

- * Avoid using this product in the food zone. (Refer to the figure on the right.)
- * When the product is used in an area of liquid splash, or a water resistant function is required for the product, please consult SMC.
- * Operate without lubrication from a pneumatic system lubricator.
- * Use the following grease pack for the maintenance work.
GR-H-010 (Grease: 10 g)
- * Please contact SMC for details on the maintenance intervals for this cylinder, which differ from those of the standard cylinder.

Specifications

Ambient temperature range	-10°C to 70°C (Without magnet) -10°C to 60°C (With magnet)
Seal material	Nitrile rubber
Grease	Grease for food processing equipment
Auto switch	Mountable
Dimensions	Same as those of the standard type
Specifications other than the above	Same as those of the standard type

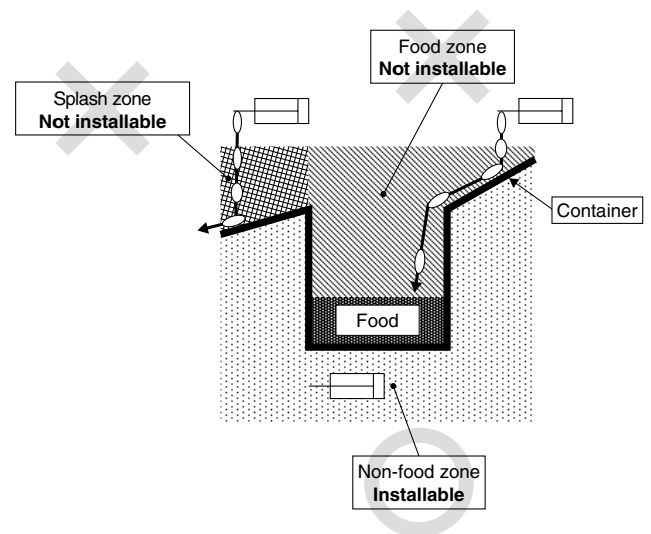

4 PTFE Grease

Symbol
-X446

Description	Model	Action	Note
Standard	CM2-Z1	Double acting, Single rod	

How to Order

Standard model no. **-X446**
PTFE grease

- * When grease is necessary for maintenance, a grease pack is available. Please order it separately.
GR-F-005 (Grease: 5 g)

Warning Precautions

Be aware that smoking cigarettes, etc., after your hands have come into contact with the grease used in this cylinder can create a gas that is hazardous to humans.

Specifications: Same as those of the standard type
Dimensions: Same as those of the standard type



CM2 Series Specific Product Precautions

Be sure to read this before handling the products. Refer to the back cover for safety instructions. For actuator and auto switch precautions, refer to “Handling Precautions for SMC Products” and the “Operation Manual” on the SMC website: <https://www.smcworld.com>

Handling

⚠ Warning

1. Do not apply any torque to the cover joint.

Both the rod cover and head cover have wrench flats. When mounting the product, be sure to tighten with an appropriate amount of force.

When mounting the cylinder or screwing a fitting into the port, tighten while holding the cover on the mounting side with a wrench. In other words, do not hold the cover on the opposite side with a wrench. The applied torque may damage the cover jointed part.

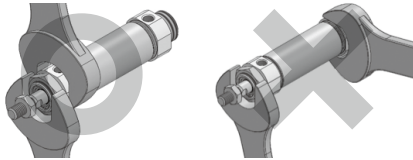

2. Operate the cylinder within the specified cylinder speed, kinetic energy, and lateral load at the rod end.

3. The allowable kinetic energy is different between the cylinders with male rod ends and with female rod ends due to the different thread sizes.

4. When a female rod end is used, depending on the material of the workpiece, use a washer etc., to prevent the contact part at the rod end from being deformed.

5. Do not apply excessive lateral load to the piston rod.

Easy checking method

Min. operating pressure after the cylinder is mounted to the equipment (MPa) = Min. operating pressure of cylinder (MPa) + {Load mass (kg) x Friction coefficient of guide/Sectional area of cylinder (mm²)}

If smooth operation is confirmed within the above value, the load on the cylinder is the resistance of the thrust only and it can be judged as having no lateral load.

6. Do not operate with the cushion needle in a fully closed condition.

Using it in the fully closed state will cause the cushion seal to be damaged. When adjusting the cushion needle, use the “Hexagon wrench key: nominal size 1.5.”

7. Do not open the cushion needle wide excessively.

If the cushion needle were set to be completely wide, it would be equivalent to the cylinder with no cushion, thus making the impacts extremely high. Do not use it in such a way. Besides, using with fully open could give damage to the piston or cover.

⚠ Warning

8. Do not open the cushion needle after rotating it numerous times in a row. Though uncommon, there are cases in which the cushion needle may leak air.

The cushion needle should be adjusted by gradually opening it while checking the operation of the cylinder cushion. In the unlikely event that air leakage occurs, return the cushion needle to the fully-closed state, and readjust the cushion needle to the desired position.

⚠ Caution

1. Cannot be disassembled.

Cover and cylinder tube are connected to each other by caulking method, thus making it impossible to disassemble. Therefore, internal parts of a cylinder other than rod seal are not replaceable.

2. Use caution to the popping of a retaining ring.

When replacing rod seals and removing and mounting a retaining ring, use a proper tool (retaining ring plier: tool for installing a type C retaining ring). Even if a proper tool is used, it is likely to inflict damage to a human body or peripheral equipment, as a retaining ring may be flown out of the tip of a plier. Be much careful with the popping of a retaining ring. Besides, be certain that a retaining ring is placed firmly into the groove of rod cover before supplying air at the time of installment.

3. Do not touch the cylinder during operation.

Use caution when handling a cylinder, which is running at a high speed and a high frequency, because the surface of the cylinder tube could get hot enough to burn you.

4. Do not use the air cylinder as an air-hydro cylinder.

The use of turbine oil as a fluid for an air cylinder may result in oil leakage.

5. The oil stuck to the cylinder is grease.

6. The base oil of the grease may seep out.

The base oil of the grease in the cylinder may seep out of the tube, cover, crimped part, or rod bushing depending on the operating conditions (ambient temperature 40°C or more, pressurized condition, low frequency operation).

7. When a rod end female thread is used, use a thin wrench when tightening the piston rod.

8. When using a rod end bracket and/or pivot bracket, make sure they do not interfere with other brackets, workpieces, rod section, etc.

Safety Instructions

These safety instructions are intended to prevent hazardous situations and/or equipment damage. These instructions indicate the level of potential hazard with the labels of “**Caution**,” “**Warning**” or “**Danger**.” They are all important notes for safety and must be followed in addition to International Standards (ISO/IEC)*1), and other safety regulations.

 **Caution:** **Caution** indicates a hazard with a low level of risk which, if not avoided, could result in minor or moderate injury.

 **Warning:** **Warning** indicates a hazard with a medium level of risk which, if not avoided, could result in death or serious injury.

 **Danger:** **Danger** indicates a hazard with a high level of risk which, if not avoided, will result in death or serious injury.

*1) ISO 4414: Pneumatic fluid power – General rules relating to systems.
ISO 4413: Hydraulic fluid power – General rules relating to systems.
IEC 60204-1: Safety of machinery – Electrical equipment of machines.
(Part 1: General requirements)
ISO 10218-1: Manipulating industrial robots – Safety.
etc.

Warning

1. The compatibility of the product is the responsibility of the person who designs the equipment or decides its specifications.

Since the product specified here is used under various operating conditions, its compatibility with specific equipment must be decided by the person who designs the equipment or decides its specifications based on necessary analysis and test results. The expected performance and safety assurance of the equipment will be the responsibility of the person who has determined its compatibility with the product. This person should also continuously review all specifications of the product referring to its latest catalog information, with a view to giving due consideration to any possibility of equipment failure when configuring the equipment.

2. Only personnel with appropriate training should operate machinery and equipment.

The product specified here may become unsafe if handled incorrectly. The assembly, operation and maintenance of machines or equipment including our products must be performed by an operator who is appropriately trained and experienced.

3. Do not service or attempt to remove product and machinery/equipment until safety is confirmed.

1. The inspection and maintenance of machinery/equipment should only be performed after measures to prevent falling or runaway of the driven objects have been confirmed.
2. When the product is to be removed, confirm that the safety measures as mentioned above are implemented and the power from any appropriate source is cut, and read and understand the specific product precautions of all relevant products carefully.
3. Before machinery/equipment is restarted, take measures to prevent unexpected operation and malfunction.

4. Contact SMC beforehand and take special consideration of safety measures if the product is to be used in any of the following conditions.

1. Conditions and environments outside of the given specifications, or use outdoors or in a place exposed to direct sunlight.
2. Installation on equipment in conjunction with atomic energy, railways, air navigation, space, shipping, vehicles, military, medical treatment, combustion and recreation, or equipment in contact with food and beverages, emergency stop circuits, clutch and brake circuits in press applications, safety equipment or other applications unsuitable for the standard specifications described in the product catalog.
3. An application which could have negative effects on people, property, or animals requiring special safety analysis.
4. Use in an interlock circuit, which requires the provision of double interlock for possible failure by using a mechanical protective function, and periodical checks to confirm proper operation.

Caution

1. The product is provided for use in manufacturing industries.

The product herein described is basically provided for peaceful use in manufacturing industries.
If considering using the product in other industries, consult SMC beforehand and exchange specifications or a contract if necessary.
If anything is unclear, contact your nearest sales branch.

Limited warranty and Disclaimer/ Compliance Requirements

The product used is subject to the following “Limited warranty and Disclaimer” and “Compliance Requirements”.

Read and accept them before using the product.

Limited warranty and Disclaimer

1. The warranty period of the product is 1 year in service or 1.5 years after the product is delivered, whichever is first.*2)
Also, the product may have specified durability, running distance or replacement parts. Please consult your nearest sales branch.
2. For any failure or damage reported within the warranty period which is clearly our responsibility, a replacement product or necessary parts will be provided.
This limited warranty applies only to our product independently, and not to any other damage incurred due to the failure of the product.
3. Prior to using SMC products, please read and understand the warranty terms and disclaimers noted in the specified catalog for the particular products.

*2) Vacuum pads are excluded from this 1 year warranty.

A vacuum pad is a consumable part, so it is warranted for a year after it is delivered.
Also, even within the warranty period, the wear of a product due to the use of the vacuum pad or failure due to the deterioration of rubber material are not covered by the limited warranty.

Compliance Requirements

1. The use of SMC products with production equipment for the manufacture of weapons of mass destruction (WMD) or any other weapon is strictly prohibited.
2. The exports of SMC products or technology from one country to another are governed by the relevant security laws and regulations of the countries involved in the transaction. Prior to the shipment of a SMC product to another country, assure that all local rules governing that export are known and followed.

Caution

SMC products are not intended for use as instruments for legal metrology.

Measurement instruments that SMC manufactures or sells have not been qualified by type approval tests relevant to the metrology (measurement) laws of each country. Therefore, SMC products cannot be used for business or certification ordained by the metrology (measurement) laws of each country.

Safety Instructions

Be sure to read the “Handling Precautions for SMC Products” (M-E03-3) and “Operation Manual” before use.