

Compact Guide Cylinder/Wide Type

MGPW Series

∅20, ∅25, ∅32, ∅40, ∅50, ∅63

Doubling the guide pitch

doubles the allowable plate rotational torque.

1.63 N·m ← **0.75 N·m**

For MGPWM20-50

- The allowable rotational torque of the plate is improved by up to 3 times by making the guide pitch twice the basic type and placing the guide components at an optimal location.
- Suitable when used as a pusher or lifter.

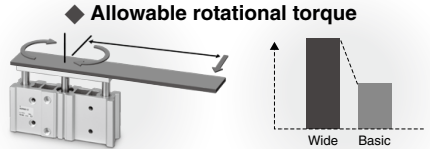

Non-rotating accuracy of the plate improved

±0.03° ← **±0.09°**

Wide type
For MGPWL20

Basic type
For MGPL20

- The plate non-rotating accuracy is improved due to the increase in guide pitch.

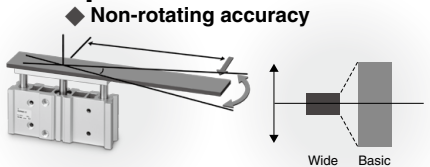

Equivalent weight to the basic type

- Although the volume is 170% more than the MGP basic type, the weight of the MGP wide type is equivalent to the basic type by changing the plate material and optimizing the component dimensions.

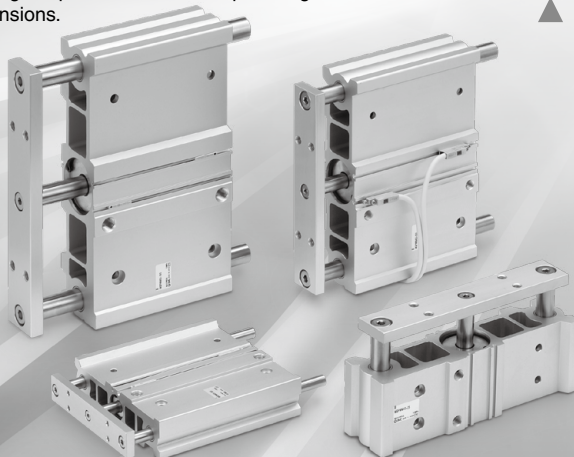
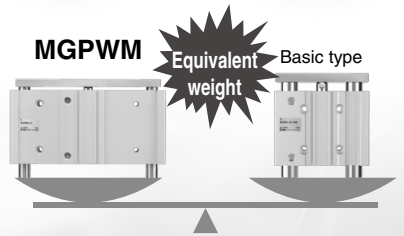

MGJ

JMGP

MGP

MGPW

MGQ

MGG

MGC

MGF

MGZ

MGT

D-□

-X□

Compact Guide Cylinder/Wide Type

3 bearing types are available for various applications.

Slide bearing MGPWM Series

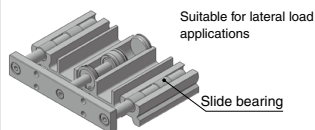

Ball bushing MGPWL Series

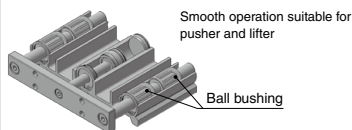

High precision ball bushing MGPWA Series

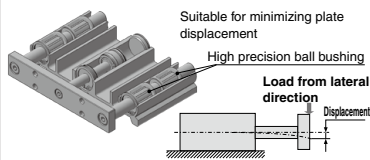

Transfer of large workpieces

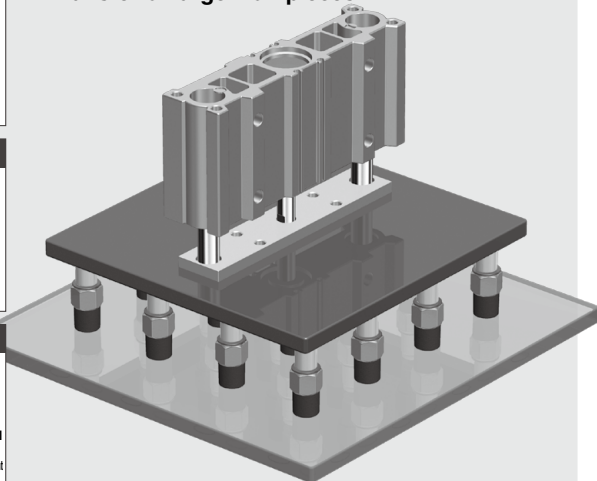

Knock pin hole is available as made to order.

If a knock pin is required on the plate or body, "-XC56: With knock pin holes" model is available as a made to order.

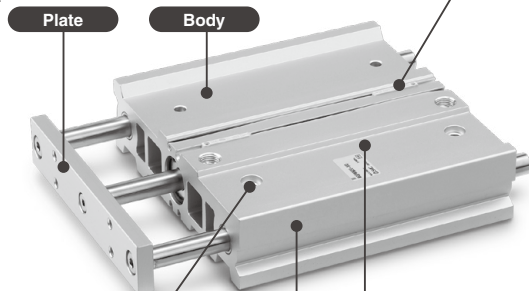

Top ported

Side porting is available as made to order.

The port is located on the top of the body in the standard type, but if side porting is required, it is also available. (-X867: Side porting type)

Small auto switches or magnetic field resistant auto switches can be mounted on 2 surfaces.

2-color indicator solid state auto switch
D-M9

Reed auto switch
D-A9

Magnetic field resistant 2-color indicator solid state auto switch
D-P3DWA

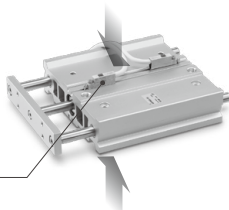





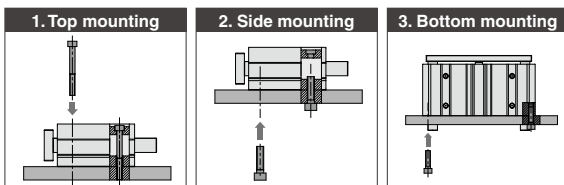

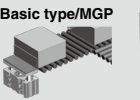

*The D-Y7 and D-Z7 auto switches are not mountable.

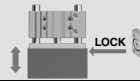
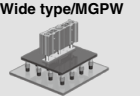
3 mounting types are possible.



Compact Guide Cylinders, Series Variations

Series	Bearing type	Bore size (mm)											Page		
		6	10	12	16	20	25	32	40	50	63	80		100	
 Basic type/MGP				●	●	●	●	●	●	●	●	●	●		P.432
 With air cushion/MGP-A	Slide bearing														P.452
	Ball bushing				●	●	●	●	●	●	●	●	●		
	High precision ball bushing														
 With end lock/MGP-H/R															P.469
 Wide type/MGPW	Slide bearing														P.498
	Ball bushing					●	●	●	●	●	●	●	●		
	High precision ball bushing														
 Clean series/12/13-MGP	Ball bushing			●	●	●	●	●	●	●	●	●	●		P.435
 Water-resistant/MGP R/V															P.435
					●	●	●	●	●	●	●	●	●	●	
 Heavy duty guide rod type/MGPS	Slide bearing											●	●		P.478
 Miniature Guide Rod Cylinder/MGJ		●	●												P.401
 Compact Guide Cylinder with Lock/MLGP	Slide bearing														P.1075
	Ball bushing					●	●	●	●	●	●	●	●	●	
 Hygienic Design Cylinder/HYG	Slide bearing					●	●	●	●	●	●	●	●		Best Pneumatics No.2-1

- MGJ
- JMGP
- MGP
- MGPW
- MGQ
- MGG
- MGC
- MGF
- MGZ
- MGT

MGPW Series (Wide type), Stroke Variations

Bearing type	Bore size (mm)	Stroke (mm)							
		25	50	75	100	125	150	175	200
MGPWM	20	●	●	●	●	●	●	●	●
Slide bearing	25	●	●	●	●	●	●	●	●
MGPWL	32	●	●	●	●	●	●	●	●
Ball bushing	40	●	●	●	●	●	●	●	●
MGPWA	50	●	●	●	●	●	●	●	●
High precision ball bushing	63	●	●	●	●	●	●	●	●

- D-□
- X□

Compact Guide Cylinder/Wide Type

MGPW Series

ø20, ø25, ø32, ø40, ø50, ø63

How to Order

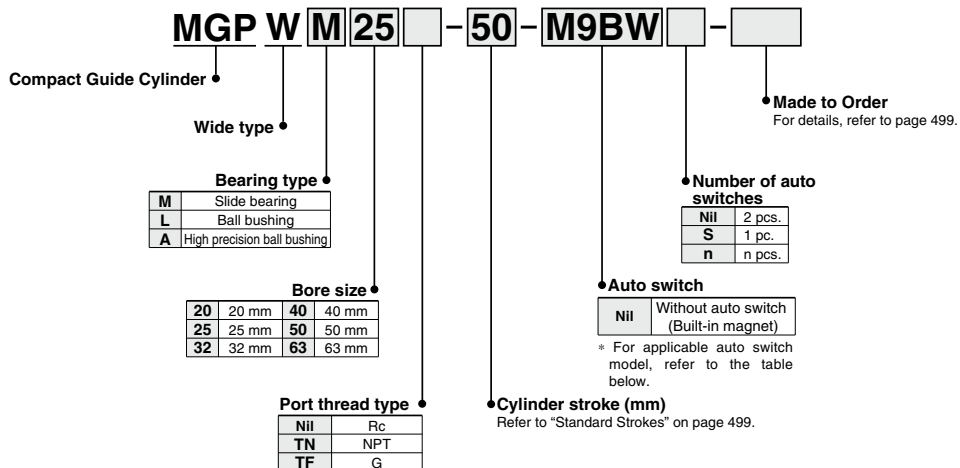

Applicable Auto Switches/Refer to pages 1119 to 1245 for further information on auto switches.

Type	Special function	Electrical entry	Indicator light	Wiring (Output)	Load voltage		Auto switch model		Lead wire length (m)					Pre-wired connector	Applicable load	
					DC	AC	Perpendicular	In-line	0.5 (Nil)	1 (M)	3 (L)	5 (Z)				
Solid state auto switch	—	Grommet	Yes	3-wire (NPN)	5 V, 12 V	—	M9NV	M9N	●	●	○	○	○	IC circuit	Relay, PLC	
				3-wire (PNP)			M9PV	M9P	●	●	○	○				
				2-wire	M9BV		M9B	●	●	○	○					
	3-wire (NPN)			5 V, 12 V	M9NVV		M9NW	●	●	○	○	IC circuit				
	3-wire (PNP)				M9PVV		M9PW	●	●	○	○					
	2-wire			12 V	M9BVV		M9BW	●	●	○	○	—				
	3-wire (NPN)				5 V, 12 V		M9NAV*1	M9NA*1	○	○	●		○			IC circuit
3-wire (PNP)	12 V	M9PAV*1	M9PA*1	○		○	○	○	—							
2-wire		—	M9BAV*1	M9BA*1	○	○	●	○		—						
Magnetic field resistant (2-color indicator)	2-wire (Non-polar)		—	—	P3DWA**	○	○	●	○		—					
Reed auto switch	—	Grommet	Yes	3-wire (NPN equivalent)	—	5 V	A96V	A96	●	—		—	—	—	IC circuit	—
				2-wire	24 V	12 V	100 V	A93V*2	A93	●	●	●	●	—	—	Relay, PLC
							100 V or less	A90V	A90	●	—	●	—	—	—	IC circuit

*1 Water-resistant type auto switch can be mounted to the models with the above mentioned part numbers, but this does not guarantee the water resistance of the cylinder. A water-resistant type cylinder is recommended for use in an environment which requires water resistance.

*2 1 m type lead wire is only applicable to D-A93.

* Lead wire length symbols: 0.5 m Nil (Example) M9NW
 1 m M (Example) M9NWM
 3 m L (Example) M9NWL
 5 m Z (Example) M9NWZ

* Solid state auto switches marked with "○" are produced upon receipt of order.
 ** Bore sizes ø32 to ø63 are available for the D-P3DWA□.

* Since there are other applicable auto switches than listed, refer to page 515 for details.

* For details about auto switches with pre-wired connector, refer to pages 1192 and 1193.

* Auto switches are shipped together, (but not assembled).

Specifications

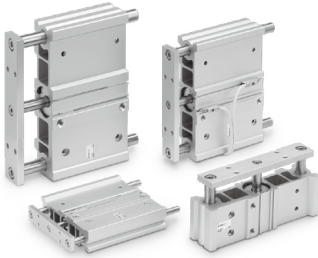

Bore size (mm)	20	25	32	40	50	63
Action	Double acting					
Fluid	Air					
Proof pressure	1.5 MPa					
Maximum operating pressure	1.0 MPa					
Minimum operating pressure	0.1 MPa					
Ambient and fluid temperature	-10 to 60°C (No freezing)					
Piston speed <small>Note)</small>	50 to 500 mm/s					
Cushion	Rubber bumper on both ends					
Lubrication	Not required (Non-lube)					
Stroke length tolerance	± 1.5 0 mm					

Note) Speed with no load

Standard Strokes

Bore size (mm)	Standard stroke (mm)
20 to 63	25, 50, 75, 100, 125, 150, 175, 200

Manufacture of Intermediate Strokes

Refer to pages 514 to 516 for cylinders with auto switches.

- Auto switch proper mounting position (detection at stroke end) and its mounting height
- Minimum stroke for auto switch mounting
- Auto switch mounting brackets/Part no.

Description	Spacer installation Spacers are installed in the standard stroke cylinder. <ul style="list-style-type: none"> • ø20 to ø32: Available in 1 mm stroke increments. • ø40 to ø63: Available in 5 mm stroke increments. 	
Part no.	Refer to "How to Order" for the standard model numbers.	
Applicable stroke (mm)	ø20 to ø32	1 to 199
	ø40 to ø63	5 to 195
Example	Part no.:MGPWM20-49 A spacer 1 mm in width is installed in a MGPWM20-50. C dimension (Body length): 84 mm	

Made to Order
Made to Order: Individual Specifications
 (For details, refer to page 517.)

Symbol	Description
-X867	Side porting type

Made to Order
[Click here for details](#)

Symbol	Description
-XC56	With knock pin holes

Theoretical Output



Bore size (mm)	Rod size (mm)	Operating direction	Piston area (mm ²)	Operating pressure (MPa)									
				0.2	0.3	0.4	0.5	0.6	0.7	0.8	0.9	1.0	
20	10	OUT	314	63	94	126	157	188	220	251	283	314	
		IN	236	47	71	94	118	141	165	188	212	236	
25	10	OUT	491	98	147	196	245	295	344	393	442	491	
		IN	412	82	124	165	206	247	289	330	371	412	
32	14	OUT	804	161	241	322	402	483	563	643	724	804	
		IN	650	130	195	260	325	390	455	520	585	650	
40	14	OUT	1257	251	377	503	628	754	880	1005	1131	1257	
		IN	1103	221	331	441	551	662	772	882	992	1103	
50	18	OUT	1963	393	589	785	982	1178	1374	1571	1767	1963	
		IN	1709	342	513	684	855	1025	1196	1367	1538	1709	
63	18	OUT	3117	623	935	1247	1559	1870	2182	2494	2806	3117	
		IN	2863	573	859	1145	1431	1718	2004	2290	2576	2863	

Note) Theoretical output (N) = Pressure (MPa) x Piston area (mm²)

MGJ

JMGP

MGP

MGPW

MGQ

MGG

MGC

MGF

MGZ

MGT

D-□

-X□

MGPW Series

Weight

Slide Bearing: MGPWM

Bore size (mm)	Standard stroke (mm)								(kg)
	25	50	75	100	125	150	175	200	
20	0.63	0.86	1.11	1.33	1.54	1.76	1.98	2.20	
25	0.84	1.11	1.47	1.74	2.01	2.28	2.55	2.82	
32	1.31	1.71	2.22	2.61	3.00	3.38	3.77	4.15	
40	1.53	1.98	2.54	2.97	3.40	3.83	4.26	4.69	
50	2.45	3.12	4.01	4.66	5.31	5.96	6.61	7.26	
63	3.25	4.07	5.12	5.91	6.71	7.51	8.31	9.11	

Ball Bushing: MGPWL/High Precision Ball Bushing: MGPWA

Bore size (mm)	Standard stroke (mm)								(kg)
	25	50	75	100	125	150	175	200	
20	0.65	0.92	1.15	1.37	1.61	1.83	2.05	2.28	
25	0.89	1.23	1.52	1.81	2.11	2.40	2.68	2.97	
32	1.36	1.76	2.22	2.61	3.03	3.41	3.80	4.18	
40	1.58	2.02	2.53	2.96	3.43	3.86	4.29	4.72	
50	2.51	3.19	3.94	4.59	5.26	5.91	6.55	7.20	
63	3.32	4.14	5.04	5.84	6.66	7.46	8.26	9.06	

Allowable Rotational Torque of Plate

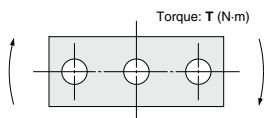

Bore size (mm)	Bearing type	Stroke (mm)								T (N-m)
		25	50	75	100	125	150	175	200	
20	MGPWM	2.10	1.63	1.74	1.51	1.34	1.20	1.08	0.99	
	MGPWL/A	3.97	4.36	3.46	2.87	3.93	3.45	3.07	2.76	
25	MGPWM	3.53	2.74	3.28	2.90	2.59	2.34	2.14	1.97	
	MGPWL/A	6.88	6.78	5.43	4.51	6.27	5.51	4.90	4.40	
32	MGPWM	7.98	6.39	7.00	6.19	5.54	5.02	4.59	4.22	
	MGPWL/A	11.13	8.48	11.14	9.36	12.46	11.00	9.83	8.87	
40	MGPWM	8.80	7.04	7.72	6.82	6.11	5.54	5.06	4.66	
	MGPWL/A	12.26	9.34	12.27	10.31	13.73	12.12	10.83	9.77	
50	MGPWM	17.57	14.28	16.17	14.44	13.04	11.89	10.93	10.11	
	MGPWL/A	17.08	13.20	19.64	16.62	20.45	18.10	16.19	14.61	
63	MGPWM	19.80	16.09	18.23	16.28	14.70	13.41	12.32	11.40	
	MGPWL/A	19.18	14.81	22.07	18.66	22.98	20.33	18.18	16.39	

Non-rotating Accuracy of Plate

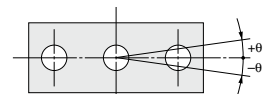

Non-rotating accuracy θ when the plate is retracted and when no load is applied is not more than the values shown in the table as a guide line.

Bore size (mm)	Non-rotating accuracy θ		
	MGPWM	MGPWL	MGPWA
20	$\pm 0.05^\circ$	$\pm 0.03^\circ$	$\pm 0.01^\circ$
25			
32			
40	$\pm 0.04^\circ$	$\pm 0.03^\circ$	$\pm 0.01^\circ$
50			
63	$\pm 0.03^\circ$		

High Precision Ball Bushing/MGPWA Plate Displacement Amount (Reference Values)

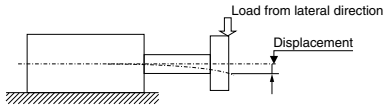

MGPWA20

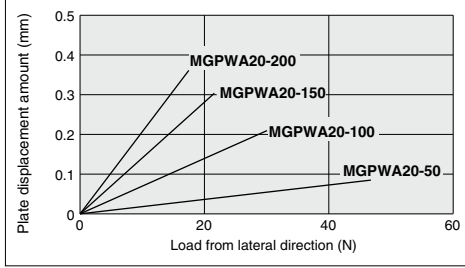

MGPWA32, 40

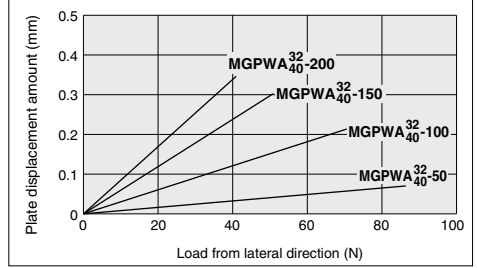

MGPWA25

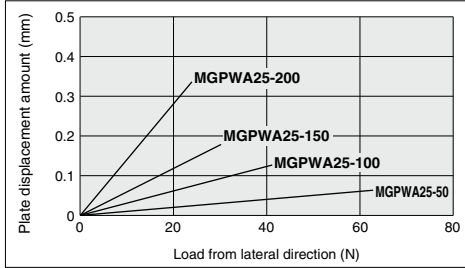

MGPWA50, 63

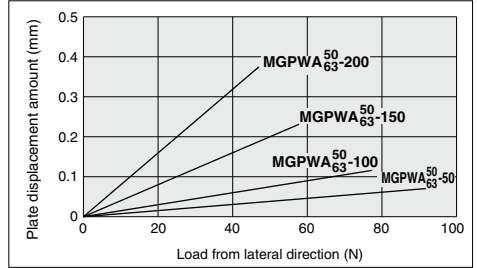

Note 1) The guide rod and self-weight for the plate are not included in the above displacement values.
 Note 2) Allowable rotating torque, and operating range when used as a lifter, are the same as MGPWL series.

- MGJ
- JMGP
- MGP
- MGPW
- MGQ
- MGG
- MGC
- MGF
- MGZ
- MGT

- D-□
- X□

MGPW Series Model Selection

Selection Conditions

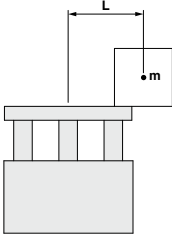
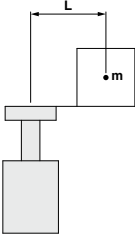
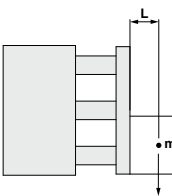
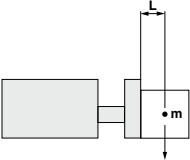
Mounting orientation	Vertical		Horizontal	
				
Maximum speed (mm/s)	200 or less	400	200 or less	400
Graph (Slide bearing type)	(1), (2)	(3), (4)	(17), (18)	(19), (20)
Graph (Ball bushing type)	(5) to (10)	(11) to (16)	(21) to (24)	(25) to (28)

Selection Example 1 (Vertical Mounting)

Selection conditions
 Mounting: Vertical
 Bearing type: Ball bushing
 Stroke: 50 stroke
 Maximum speed: 200 mm/s
 Load mass: 3 kg
 Eccentric distance: 90 mm

Find the point of intersection for the load mass of 3 kg and the eccentric distance of 90 mm on graph (6), based on vertical mounting, ball bushing, 50 stroke, and the speed of 200 mm/s.
 → MGPWL20-50 is selected.

(6) 26 to 100 stroke, V = 200 mm/s or less

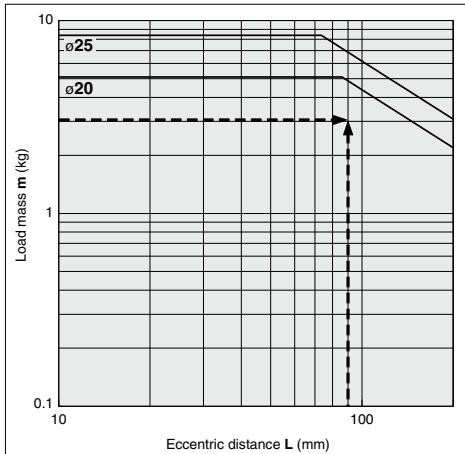

Selection Example 2 (Horizontal Mounting)

Selection conditions
 Mounting: Horizontal
 Bearing type: Slide bearing
 Distance between plate and load center of gravity: 50 mm
 Maximum speed: 200 mm/s
 Load mass: 2 kg
 Stroke: 30 stroke

Find the point of intersection for the load mass of 2 kg and 30 stroke on graph (17), based on horizontal mounting, slide bearing, the distance of 50 mm between the plate and load center of gravity, and the speed of 200 mm/s.
 → MGPWM20-30 is selected.

(17) L = 50 mm, V = 200 mm/s or less

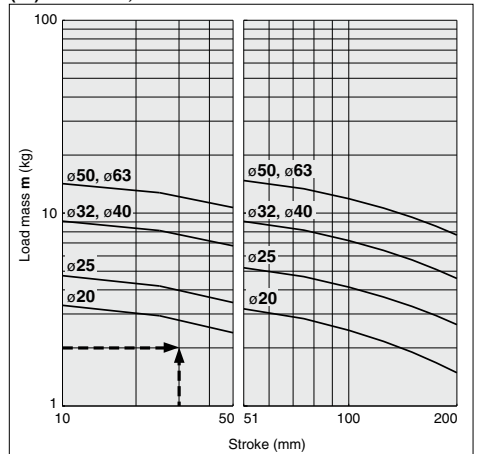

When the maximum speed exceeds 200 mm/s, the allowable load mass is determined by multiplying the value shown in the graph at 400 mm/s by the coefficient listed in the table below.

Max. speed	Up to 300 mm/s	Up to 400 mm/s	Up to 500 mm/s
Coefficient	1.7	1	0.6

Vertical Mounting Slide bearing

— Operating pressure 0.5 MPa

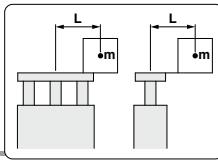

MGPWM20 to 63

(1) 50 stroke or less, V = 200 mm/s or less

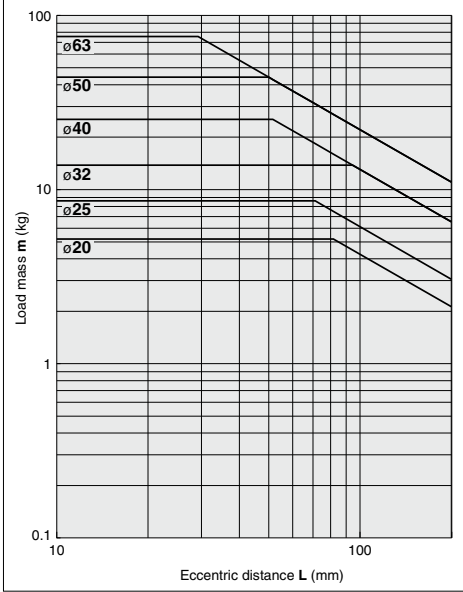

(2) Over 50 stroke, V = 200 mm/s or less

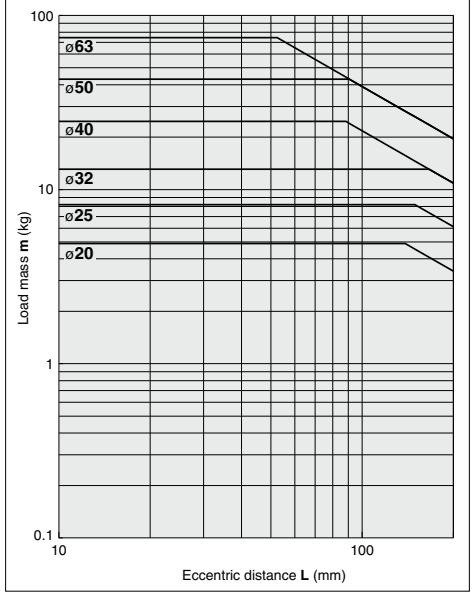

(3) 50 stroke or less, V = 400 mm/s or less

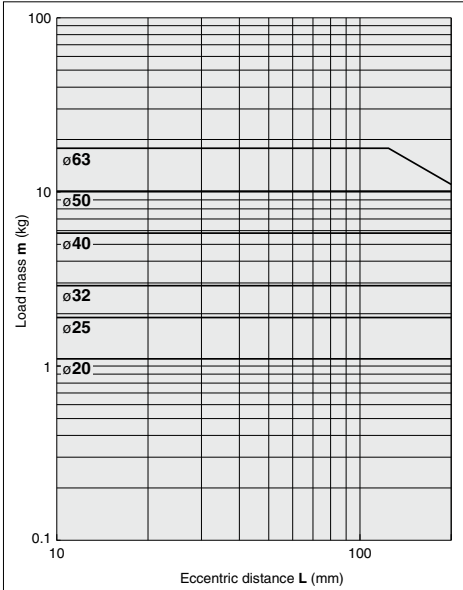

(4) Over 50 stroke, V = 400 mm/s or less

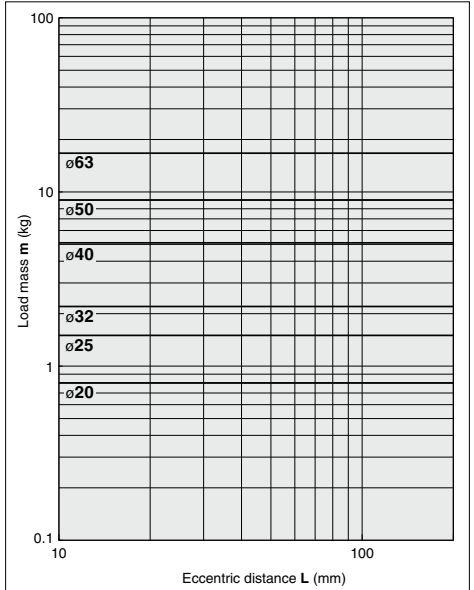

MGJ

JMGP

MGP

MGPW

MGQ

MGG

MGC

MGF

MGZ

MGT

D-□

-X□

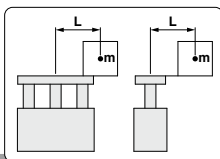

Vertical Mounting **Ball bushing**

— Operating pressure 0.5 MPa

MGPWL20 to 25, MGPWA20 to 25

(5) 25 stroke or less, $V = 200 \text{ mm/s}$ or less

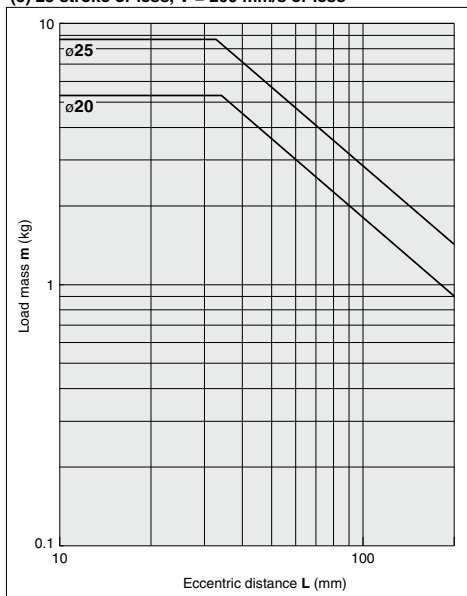

(6) Over 26 stroke, 100 stroke or less, $V = 200 \text{ mm/s}$ or less

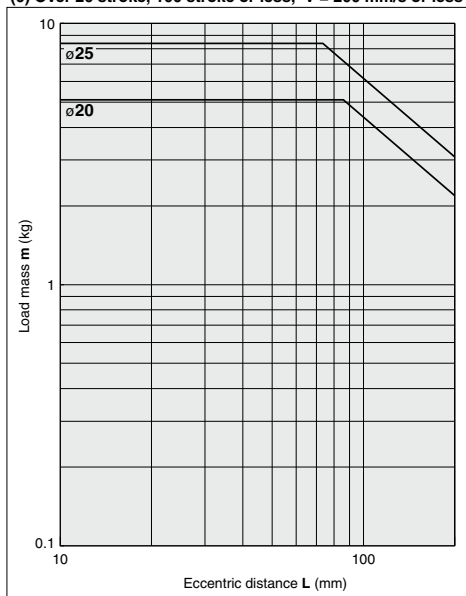

(7) Over 101 stroke, 200 stroke or less, $V = 200 \text{ mm/s}$ or less

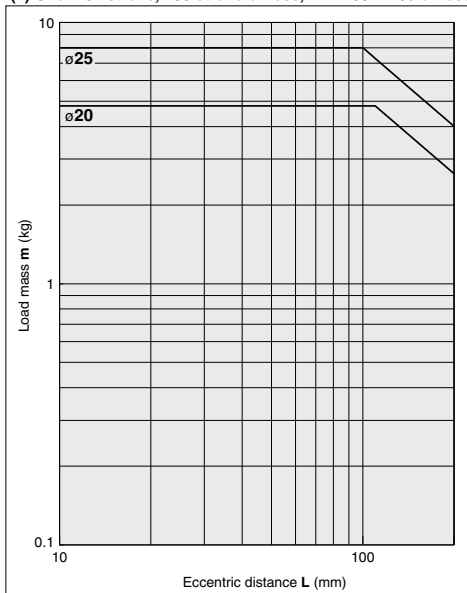

Vertical Mounting **Ball bushing**

— Operating pressure 0.5 MPa

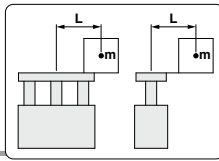

MGPWL32 to 63, MGPWA32 to 63

(8) 50 stroke or less, V = 200 mm/s or less

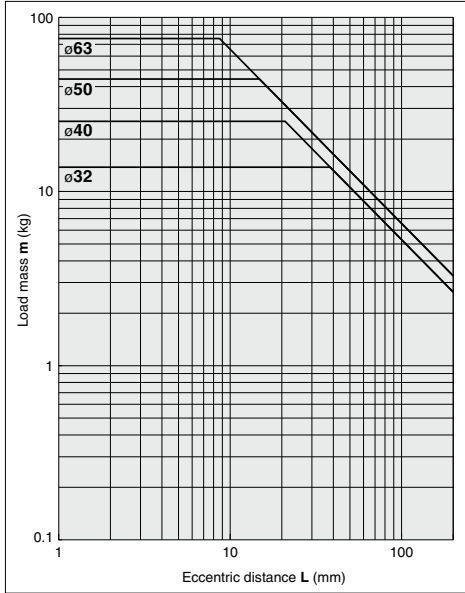

(9) Over 51 stroke, 100 stroke or less, V = 200 mm/s or less

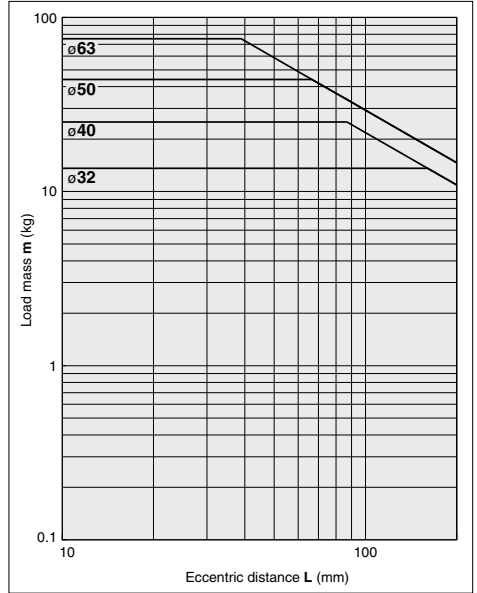

(10) Over 101 stroke, 200 stroke or less, V = 200 mm/s or less

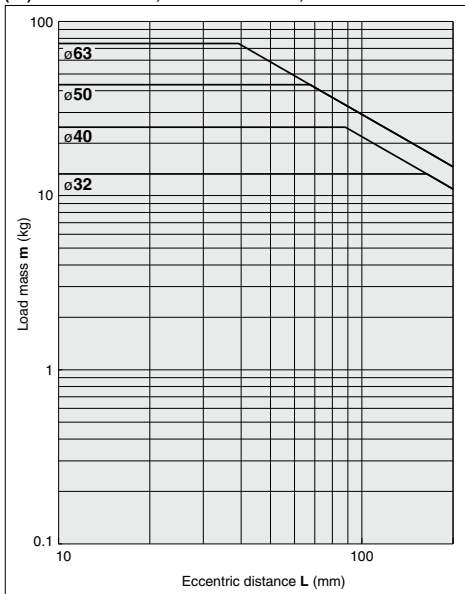

MGJ

JMGP

MGP

MGPW

MGQ

MGG

MGC

MGF

MGZ

MGT

D-□

-X□

MGPW Series

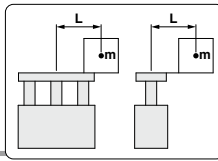

Vertical Mounting **Ball bushing**

— Operating pressure 0.5 MPa

MGPWL20 to 25, MGPWA20 to 25

(11) 25 stroke or less, $V = 400$ mm/s

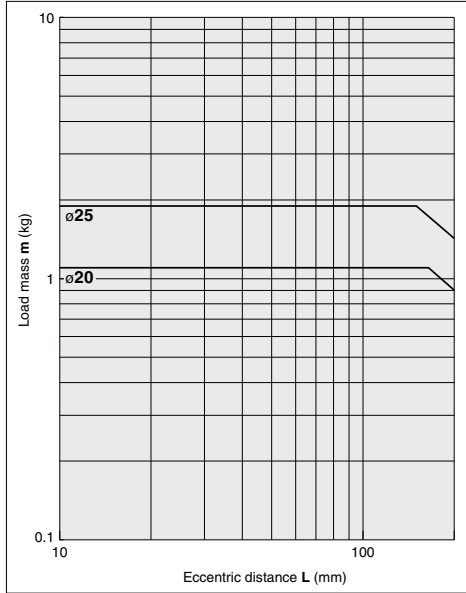

(12) Over 26 stroke, 100 stroke or less, $V = 400$ mm/s

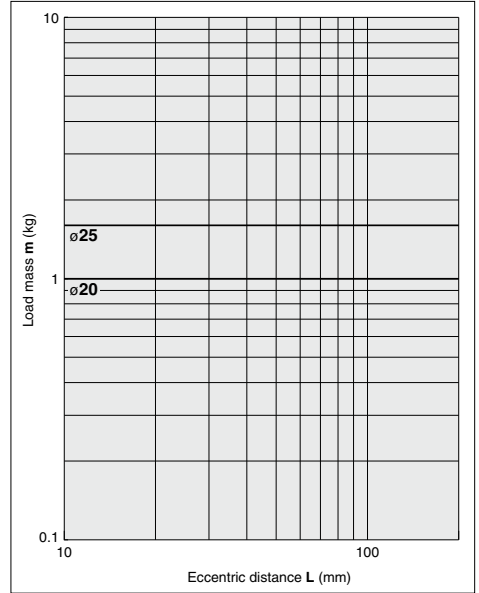

(13) Over 101 stroke, 200 stroke or less, $V = 400$ mm/s

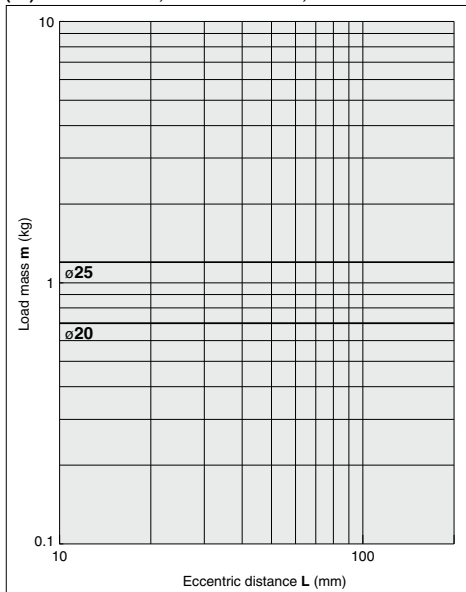

Vertical Mounting **Ball bushing**

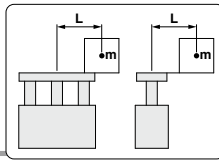

— Operating pressure 0.5 MPa

MGPWL32 to 63, MGPWA32 to 63

(14) 50 stroke or less, $V = 400$ mm/s

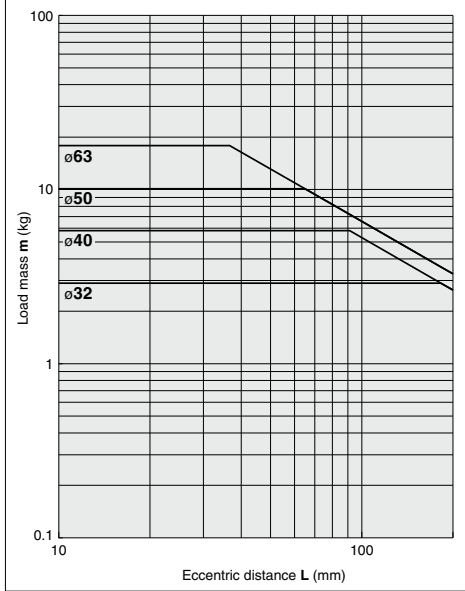

(15) Over 51 stroke, 100 stroke or less, $V = 400$ mm/s

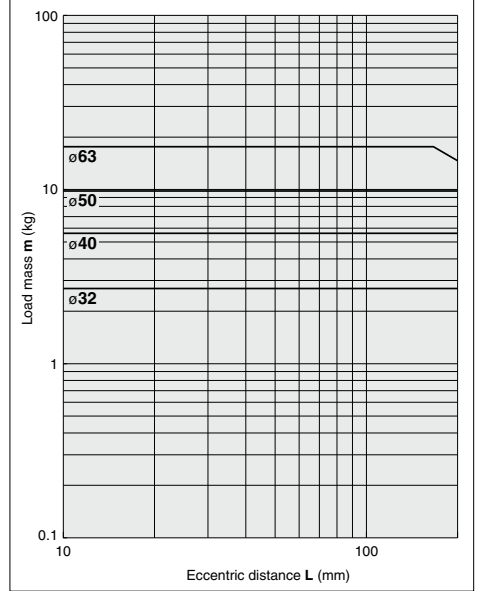

(16) Over 101 stroke, 200 stroke or less, $V = 400$ mm/s

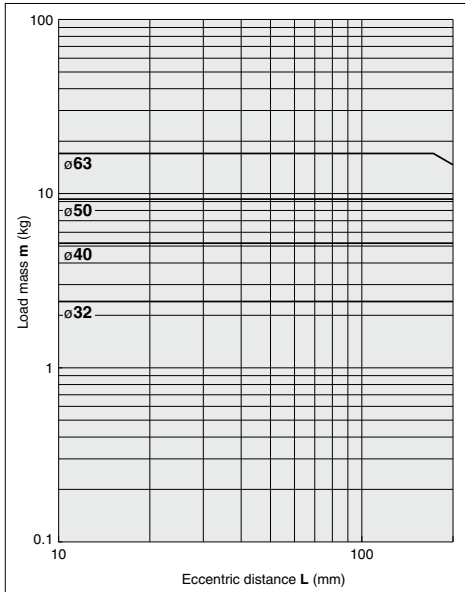

MGJ

JMGP

MGP

MGPW

MGQ

MGG

MGC

MGF

MGZ

MGT

D-□

-X□

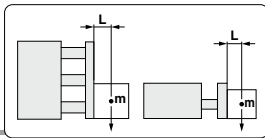

Horizontal Mounting **Slide bearing**

MGPWM20 to 63

(17) L = 50 mm, V = 200 mm/s or less

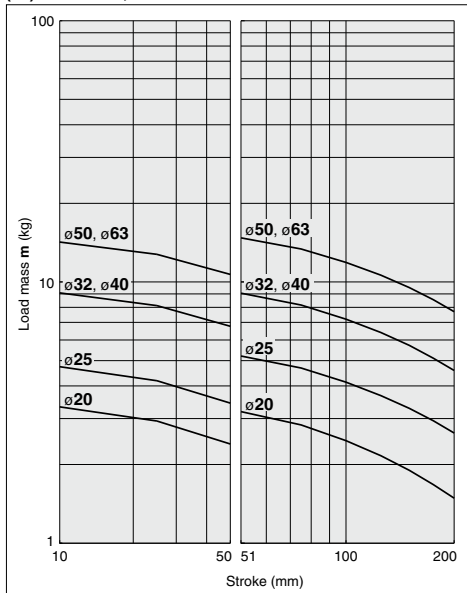

(18) L = 100 mm, V = 200 mm/s or less

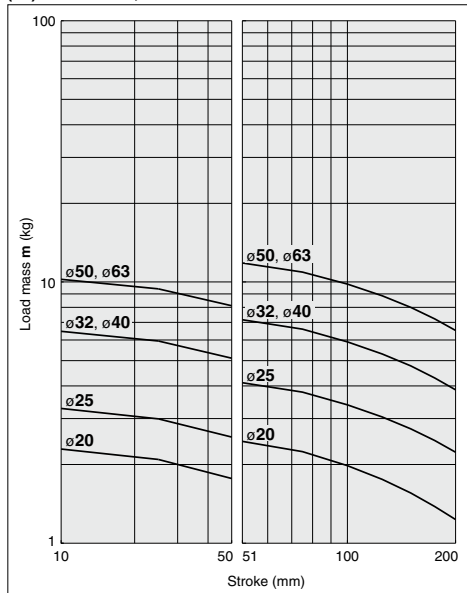

(19) L = 50 mm, V = 400 mm/s

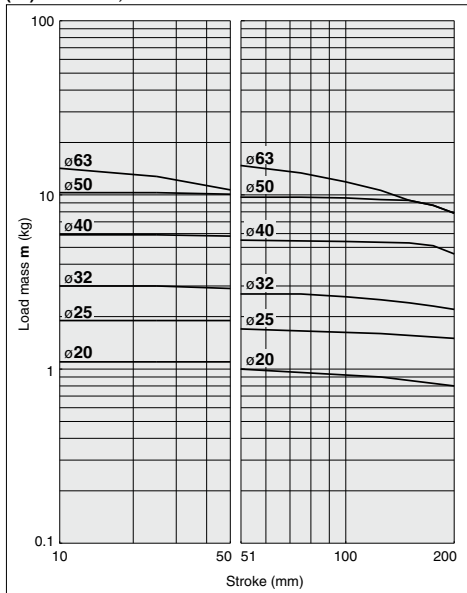

(20) L = 100 mm, V = 400 mm/s

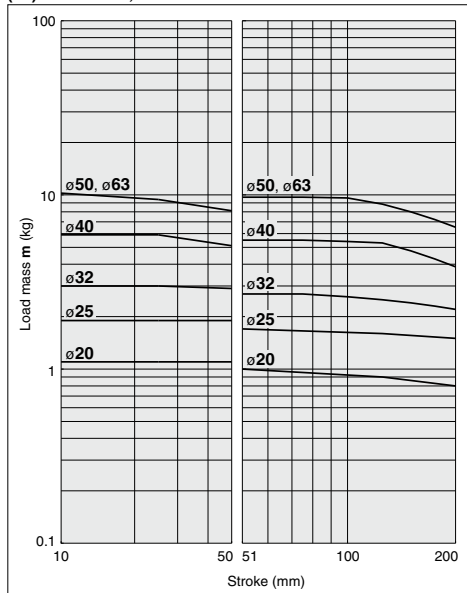

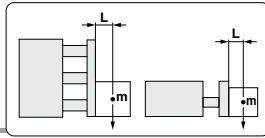

Horizontal Mounting **Ball bushing**

MGPWL20 to 25, MGPWA20 to 25

(21) L = 50 mm, V = 200 mm/s or less

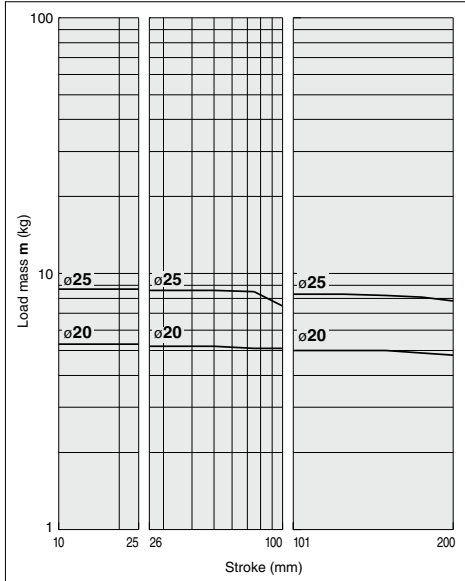

(22) L = 100 mm, V = 200 mm/s or less

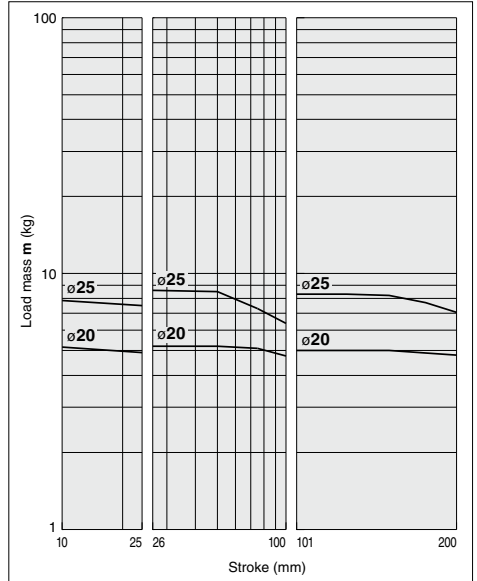

MGPWL32 to 63, MGPWA32 to 63

(23) L = 50 mm, V = 200 mm/s or less

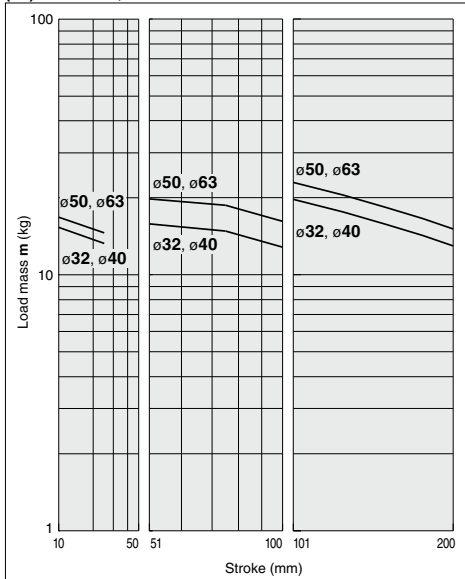

(24) L = 100 mm, V = 200 mm/s or less

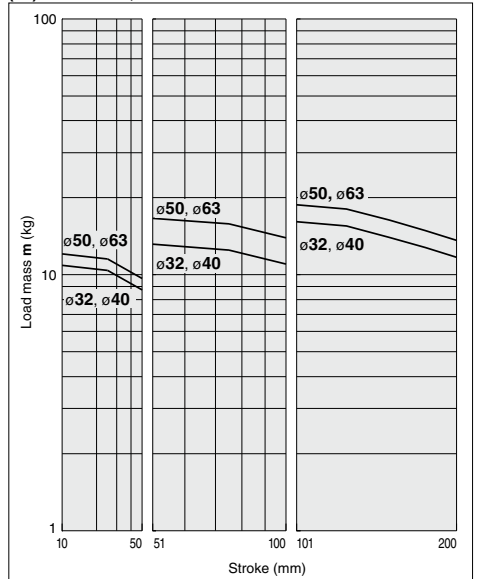

MGJ

JMGP

MGP

MGPW

MGQ

MGG

MGC

MGF

MGZ

MGT

D-

-X

MGPW Series

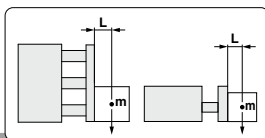

Horizontal Mounting **Ball bushing**

MGPWL20 to 25, MGPWA20 to 25

(25) L = 50 mm, V = 400 mm/s or less

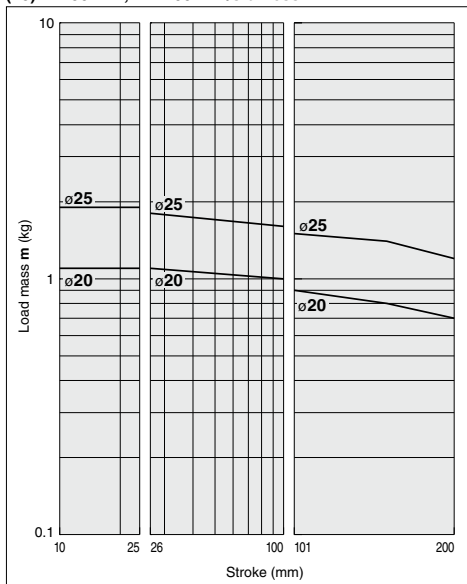

(26) L = 100 mm, V = 400 mm/s or less

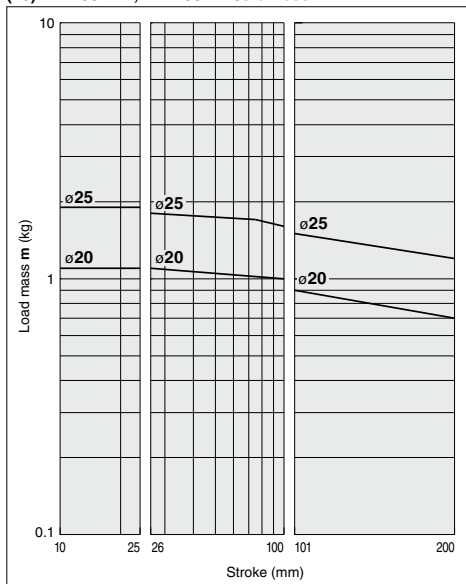

MGPWL32 to 63, MGPWA32 to 63

(27) L = 50 mm, V = 400 mm/s or less

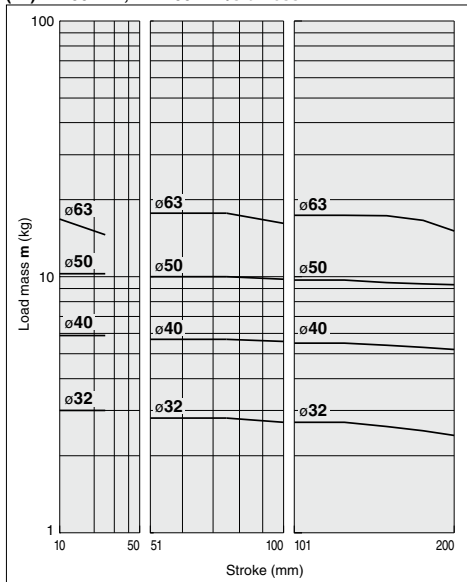

(28) L = 100 mm, V = 400 mm/s or less

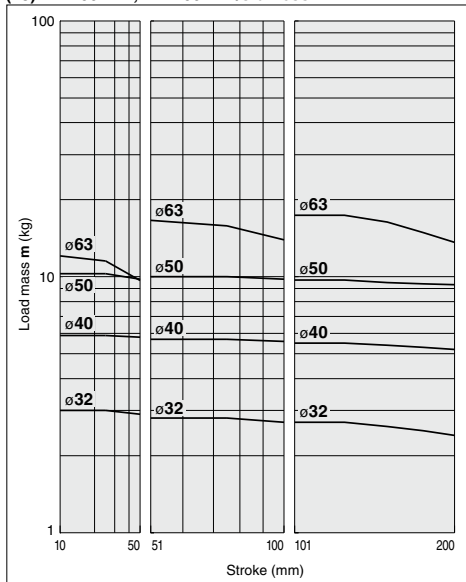

Construction/MGPWM, MGPWL, MGPWA Series

MGPWM20 to 63

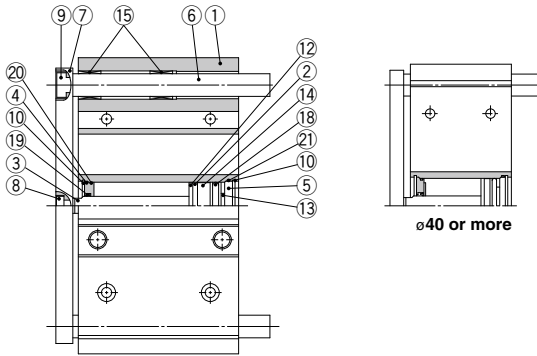

**MGPWL20 to 63
MGPWA20 to 63**

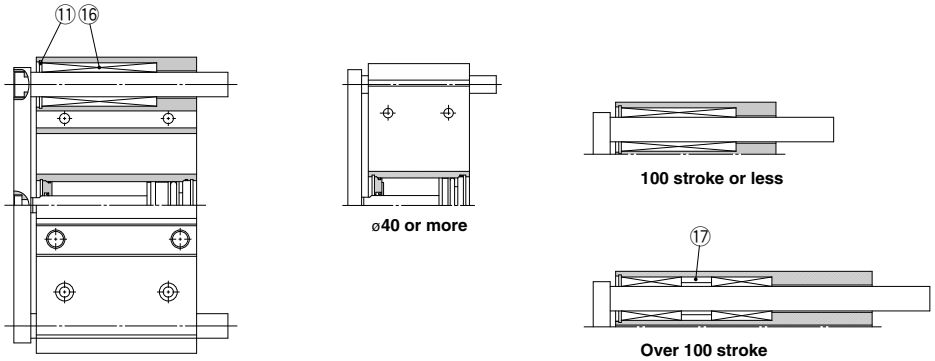

Component Parts

No.	Description	Material	Note
1	Body	Aluminum alloy	Hard anodized
2	Piston	Aluminum alloy	Chromated
3	Piston rod	Stainless steel	ø20 to ø25
		Carbon steel	ø32 to ø63 Hard chrome plated
4	Collar	Aluminum alloy	Chromated
5	Head cover	Aluminum alloy	Chromated
6	Guide rod	Carbon steel	Hard chrome plated
7	Plate	Aluminum alloy	Anodized
8	Plate mounting bolt	Carbon steel	Nickel plated
9	Guide bolt	Carbon steel	Nickel plated
10	Retaining ring	Carbon tool steel	Phosphate coated
11	Retaining ring	Carbon tool steel	Phosphate coated
12	Bumper A	Urethane	
13	Bumper B	Urethane	
14	Magnet	-	
15	Slide bearing	Babbitt	

Component Parts

No.	Description	Material	Note
16	Ball bushing		
17	Spacer	Aluminum alloy	
18*	Piston seal	NBR	
19*	Rod seal	NBR	
20*	Gasket A	NBR	
21*	Gasket B	NBR	

Replacement Parts/Seal Kit

Bore size (mm)	Kit no.	Contents	Bore size (mm)	Kit no.	Contents
20	MGP20-Z-PS	Set of nos. above	40	MGP40-Z-PS	Set of nos. above
25	MGP25-Z-PS	(18, 19, 20, 21)	50	MGP50-Z-PS	(18, 19, 20, 21)
32	MGP32-Z-PS		63	MGP63-Z-PS	

* Seal kit includes (18 to 21). Order the seal kit, based on each bore size.

* Since the seal kit does not include a grease pack, order it separately.

Grease pack part no.: GR-S-010 (10 g)

MGJ

JMGP

MGP

MGPW

MGQ

MGG

MGC

MGF

MGZ

MGT

D-□

-X□

MGPW Series

Ø20 to Ø63/MGPWM

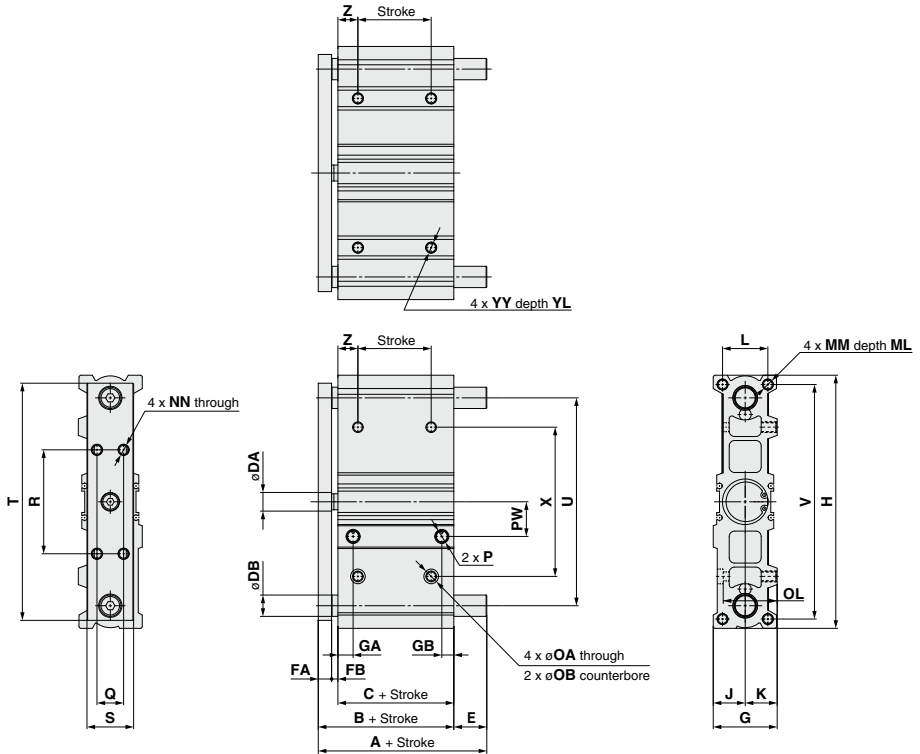

* For intermediate strokes other than standard strokes, refer to "Manufacture of Intermediate Strokes" on page 499.

MGPWM Common Dimensions

(mm)

Bore size (mm)	Standard stroke (mm)	A								E				FA	FB	G	GA	GB	H	J	K	L
		50 at or less	Over 50 stroke	B	C	DA	DB	50 at or less	Over 50 stroke													
20	25, 50, 75, 100, 125, 150, 175, 200	62	92	44.5	34	10	10	17.5	47.5	7.5	3	36	9.9	7.5	137	18	18	24				
25		63.5	113.5	47	35	10	12	16.5	66.5	9	3	42	10.3	8.7	157	21	21	30				
32		76.5	116.5	52	37	14	16	24.5	64.5	10	5	48	11.4	9	190	24	24	34				
40		76.5	116.5	56	41	14	16	20.5	60.5	10	5	54	13.5	10.5	206	27	27	40				
50		85	135	60.5	42	18	20	24.5	74.5	12.5	6	64	14	11.1	258	32	32	46				
63		85	135	67.5	49	18	20	17.5	67.5	12.5	6	78	15.5	13.5	286	39	39	58				

Bore size (mm)	MM	ML	NN	OA	OB	OL	P			PW	Q	R	S	T	U	V	X	YY	YL	Z
							NII	TN	TF											
20	M5 x 0.8	13	M5 x 0.8	5.4	9.5	30.5	Rc1/8	NPT1/8	G1/8	17	14	64	24	123	108	126	76	M6 x 1	9	20
25	M6 x 1	15	M6 x 1	5.4	9.5	36.5	Rc1/8	NPT1/8	G1/8	18	16	68	26	146	128	146	92	M6 x 1	9	20
32	M8 x 1.25	20	M8 x 1.25	6.7	11	40.5	Rc1/8	NPT1/8	G1/8	26	20	78	35	178	156	176	112	M8 x 1.25	12	20
40	M8 x 1.25	20	M8 x 1.25	6.7	11	46.5	Rc1/8	NPT1/8	G1/8	27	20	92	35	193	172	192	128	M8 x 1.25	12	23
50	M10 x 1.5	22	M10 x 1.5	8.6	14	54.5	Rc1/4	NPT1/4	G1/4	28.5	26	132	44	247	220	240	168	M10 x 1.5	15	25
63	M10 x 1.5	22	M10 x 1.5	8.6	14	68.5	Rc1/4	NPT1/4	G1/4	30	30	160	48	274	248	266	196	M10 x 1.5	15	27

∅20 to ∅63/MGPWL, MGPWA

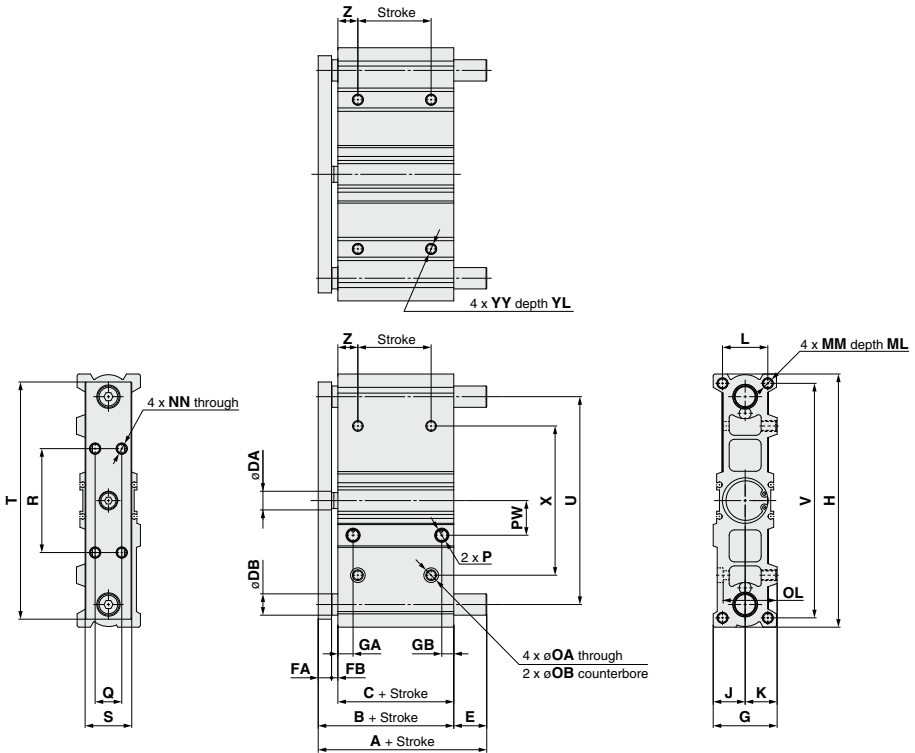

* For intermediate strokes other than standard strokes, refer to "Manufacture of Intermediate Strokes" on page 499.

MGPWL, MGPWA Common Dimensions

Bore size (mm)	Standard stroke (mm)	B	C	DA	DB	FA	FB	G	GA	GB	H	J	K	L	MM	ML
20	25, 50, 75, 100, 125, 150, 175, 200	44.5	34	10	10	7.5	3	36	9.9	7.5	137	18	18	24	M5 x 0.8	13
25		47	35	10	13	9	3	42	10.3	8.7	157	21	21	30	M6 x 1	15
32		52	37	14	16	10	5	48	11.4	9	190	24	24	34	M8 x 1.25	20
40		56	41	14	16	10	5	54	13.5	10.5	206	27	27	40	M8 x 1.25	20
50		60.5	42	18	20	12.5	6	64	14	11.1	258	32	32	46	M10 x 1.5	22
63		67.5	49	18	20	12.5	6	78	15.5	13.5	286	39	39	58	M10 x 1.5	22

Bore size (mm)	NN	OA	OB	OL	P			PW	Q	R	S	T	U	V	X	YY	YL	Z
					NII	TN	TF											
20	M5 x 0.8	5.4	9.5	30.5	Rc1/8	NPT1/8	G1/8	17	14	64	24	123	108	126	76	M6 x 1	9	20
25	M6 x 1	5.4	9.5	36.5	Rc1/8	NPT1/8	G1/8	18	16	68	26	146	128	146	92	M6 x 1	9	20
32	M8 x 1.25	6.7	11	40.5	Rc1/8	NPT1/8	G1/8	26	20	78	35	178	156	176	112	M8 x 1.25	12	20
40	M8 x 1.25	6.7	11	46.5	Rc1/8	NPT1/8	G1/8	27	20	92	35	193	172	192	128	M8 x 1.25	12	23
50	M10 x 1.5	8.6	14	54.5	Rc1/4	NPT1/4	G1/4	28.5	26	132	44	247	220	240	168	M10 x 1.5	15	25
63	M10 x 1.5	8.6	14	68.5	Rc1/4	NPT1/4	G1/4	30	30	160	48	274	248	266	196	M10 x 1.5	15	27

MGPWL, MGPWA ∅20, ∅25/A, E Dimensions

Bore size (mm)	A			E		
	25 st or less	Over 25 st or less	Over 100 st	25 st or less	Over 25 st or less	Over 100 st
20	53.5	70.5	94.5	9	26	50
25	61.5	77.5	96.5	14.5	30.5	49.5

MGPWL, MGPWA ∅32 to ∅63/A, E Dimensions

Bore size (mm)	A			E		
	50 st or less	Over 50 st or less	Over 100 st	50 st or less	Over 50 st or less	Over 100 st
32	72.5	89.5	109.5	20.5	37.5	57.5
40	72.5	89.5	109.5	16.5	33.5	53.5
50	82	103	123	21.5	42.5	62.5
63	82	103	123	14.5	35.5	55.5

MGJ

JMGP

MGP

MGPW

MGQ

MGG

MGC

MGF

MGZ

MGT

D-□

-X□

MGPW Series Auto Switch Mounting

Auto Switch Proper Mounting Position (Detection at Stroke End) and Its Mounting Height

- D-M9□
- D-M9□V
- D-M9□W
- D-M9□WV
- D-M9□A
- D-M9□AV
- D-A9□
- D-A9□V

ø20 to ø63

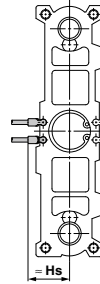
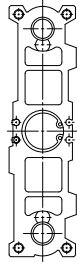
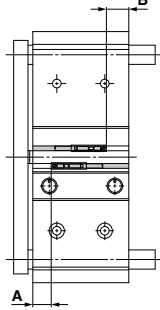

D-P3DWA

ø32 to ø63

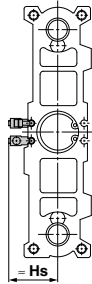
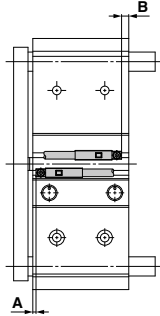

Auto Switch Proper Mounting Position (mm)

Bore size (mm)	D-M9□ D-M9□V D-M9□W D-M9□WV D-M9□A D-M9□AV		D-A9□ D-A9□V		D-P3DWA	
	A	B	A	B	A	B
	20	11	11	7	7	—
25	10.5	12.5	6.5	8.5	6	8
32	12	13	8	9	7.5	8.5
40	14	15	10	11	9.5	10.5
50	13.5	16	9.5	12	9	11.5
63	16.5	20	12.5	16	12	15.5

Auto Switch Mounting Height (mm)

Bore size (mm)	D-M9□V D-M9□WV D-M9□AV	D-A9□V	D-P3DWA
	Hs	Hs	Hs
20	24.5	22	—
25	26	24	32.5
32	29	26.5	35.5
40	33	30.5	39
50	38.5	36	44.5
63	45.5	43	51.5

Note) Adjust the auto switch after confirming the operating conditions in the actual setting.

Minimum Stroke for Auto Switch Mounting

		(mm)					
Auto switch model	No. of auto switches mounted	ø20	ø25	ø32	ø40	ø50	ø63
D-M9□	1 pc.	5 Note 1)		5			
	2 pcs.	10					
D-M9□W	1 pc.	5 Note 2)					
	2 pcs.	10					
D-M9□VV D-M9□AV	1 pc.	5 Note 2)					
	2 pcs.	10					
D-M9□A	1 pc.	5 Note 2)					
	2 pcs.	10 Note 2)					
D-M9□V	1 pc.	5					
	2 pcs.	5					
D-A9□V	1 pc.	5					
	2 pcs.	10					
D-A9□	1 pc.	5					
	2 pcs.	10					
D-P3DWA	1 pc.	—		15			
	2 pcs.	—		15			

Note 1) Confirm that it is possible to secure the minimum bending radius of 10 mm of the auto switch lead wire before use.
 Note 2) Confirm that it is possible to securely set the auto switch(es) within the range of indicator green light ON range before use.
 For in-line entry type, please also consider Note 1) shown above.
 Note 3) The D-P3DWA□ can be mounted on bore sizes ø32 to ø63.

Other than the applicable auto switches listed in “How to Order”, the following auto switches are mountable.
 Refer to pages 1119 to 1245 for detailed specifications.

Type	Model	Electrical entry	Features
Solid state switch	D-P4DW	Grommet (In-line)	Diagnostic indication (2-color indicator) Bore size: ø32 to ø63

- * With pre-wired connector is also available for solid state auto switches. For details, refer to pages 1192 and 1193.
- * Normally closed (NC = b contact) solid state auto switches (D-M9□E(V)) are also available. For details, refer to page 1592-1.
- * When installing the D-P4DW, use the BMG7-032 auto switch mounting bracket.

- MGJ
- JMGP
- MGP
- MGPW
- MGQ
- MGG
- MGC
- MGF
- MGZ
- MGT

- D-□
- X□

Auto Switch Mounting Brackets/Part No.

Applicable Cylinder Series: MGPWM, MGPWL, MGPWA

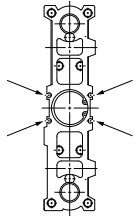
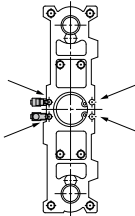
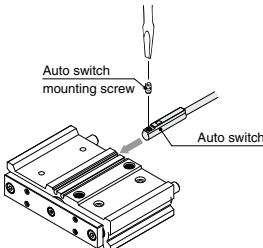
Applicable auto switches	D-M9□/M9□V D-M9□W/M9□WV D-M9□A/M9□AV D-A9□/A9□V	D-P3DWA							
Bore size (mm)	ø20 to ø63	ø32 to ø63							
Auto switch mounting bracket part no.	—	—							
Auto switch mounting bracket fitting parts lineup/Weight	—	—							
Auto switch mounting surfaces	Surfaces with auto switch mounting slot 	Surfaces with auto switch mounting slot 							
	Mounting of auto switch  <ul style="list-style-type: none">• When tightening the auto switch mounting screw, use a watchmakers' screwdriver with a handle 5 to 6 mm in diameter. Tightening Torque for Auto Switch Mounting Screw (N·m) <table border="1" data-bbox="229 1157 610 1276"> <thead> <tr> <th>Auto switch model</th> <th>Tightening torque</th> </tr> </thead> <tbody> <tr> <td>D-M9□(V) D-M9□W(V) D-A93</td> <td>0.05 to 0.15</td> </tr> <tr> <td>D-M9□A(V)</td> <td>0.05 to 0.10</td> </tr> <tr> <td>D-A9□(V) (Excludes the D-A93)</td> <td>0.10 to 0.20</td> </tr> </tbody> </table>	Auto switch model	Tightening torque	D-M9□(V) D-M9□W(V) D-A93	0.05 to 0.15	D-M9□A(V)	0.05 to 0.10	D-A9□(V) (Excludes the D-A93)	0.10 to 0.20
Auto switch model	Tightening torque								
D-M9□(V) D-M9□W(V) D-A93	0.05 to 0.15								
D-M9□A(V)	0.05 to 0.10								
D-A9□(V) (Excludes the D-A93)	0.10 to 0.20								

Note) Auto switch mounting brackets and auto switches are enclosed with the cylinder for shipment.
For an environment that needs the water-resistant auto switch, select the D-M9□A(V) type.



1 Side Porting Type

Symbol
-X867

Ports are only on the top of the cylinder for the standard model, but side ports are also available.

How to Order

MGPW -X867
 ↓
 Side porting type

Port positions

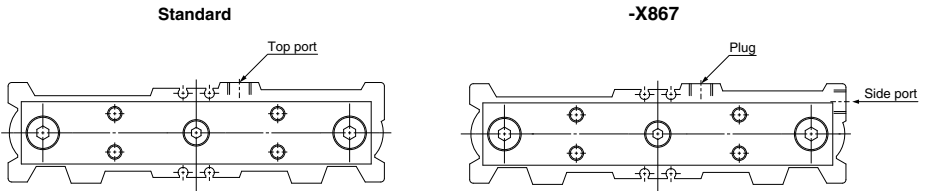

Specifications: Same as standard type

Dimensions (Dimensions other than below are the same as standard type.)

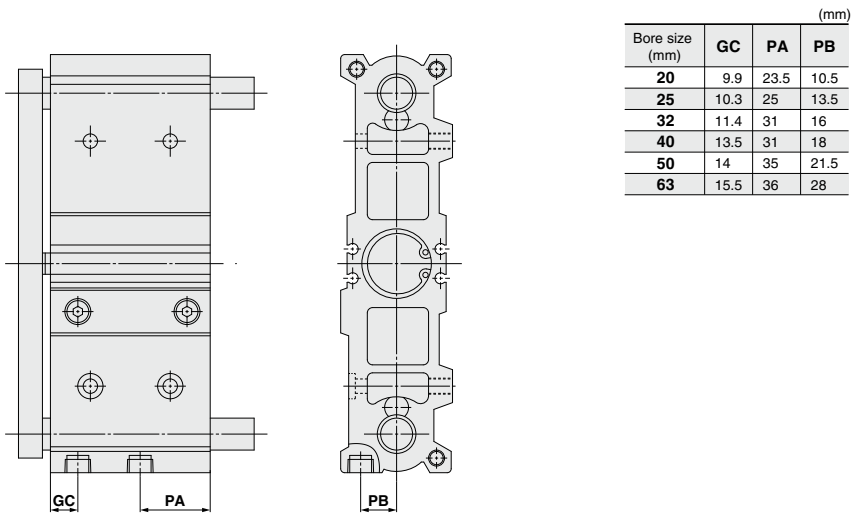

- MGJ
- JMGP
- MGP
- MGPW
- MGQ
- MGG
- MGC
- MGF
- MGZ
- MGT

- D-□
- X□



MGPW Series Specific Product Precautions

Be sure to read this before handling the products.

Refer to back page 50 for Safety Instructions and pages 3 to 12 for Actuator and Auto Switch Precautions.

Mounting

⚠ Warning

1. Never place your hands or fingers between the plate and the body.

Be very careful to prevent your hands or fingers from getting caught in the gap between the cylinder body and the plate when air is applied.

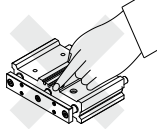

⚠ Caution

1. Use cylinders within the piston speed range.

An orifice is set for this cylinder, but the piston speed may exceed the operating range if the speed controller is not used. If the cylinder is used outside the operating speed range, it may cause damage to the cylinder and shorten the service life. Adjust the speed by installing the speed controller and use the cylinder within the limited range.

2. Pay attention to the operating speed when the product is mounted vertically.

When using the product in the vertical direction, if the load factor is large, the operating speed can be faster than the control speed of the speed controller (i.e. quick extension). In such cases, it is recommended to use a dual speed controller.

3. Do not scratch or gouge the sliding portion of the piston rod and the guide rod.

Damaged seals, etc. will result in leakage or malfunction.

4. Do not dent or scratch the mounting surface of a body and a plate.

The flatness of the mounting surface may not be maintained, which would cause an increase in sliding resistance.

5. Make sure that the cylinder mounting surface has a flatness of 0.05 mm or less.

Insufficient flatness of a workpiece or bracket mounted on the mounting surface or plate of the cylinder and other parts can cause defective operation and an increase in the sliding resistance.

6. Bottom of cylinder

The guide rods protrude from the bottom of the cylinder at the end of the retracting stroke, and therefore, in cases where the cylinder is to be bottom mounted, it is necessary to provide bypass ports in the mounting surface for the guide rods, as well as holes for the hexagon socket head cap screws which are used for mounting.

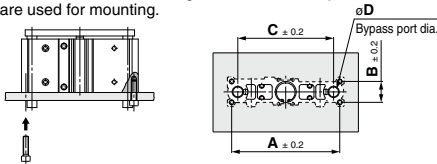

Bore size (mm)	A (mm)	B (mm)	C (mm)	D (mm)		Hexagon socket head cap screw
				MGPWM	MGPW/LA	
20	126	24	108	12	12	M5 x 0.8
25	146	30	128	14	15	M6 x 1.0
32	176	34	156	18	18	M8 x 1.25
40	192	40	172	18	18	M8 x 1.25
50	240	46	220	22	22	M10 x 1.5
63	266	58	248	22	22	M10 x 1.5

Mounting

⚠ Caution

7. Tighten the screws to the correct tightening torques specified in the table below when mounting parts on top of the cylinder.

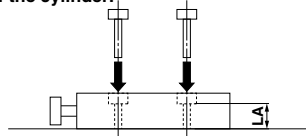

Bore size (mm)	Hexagon socket head cap screw	Tightening torque (N·m)	LA dimension (mm)
20	M5	3.0 to 4.0	30.5
25			36.5
32	M6	5.2 to 6.4	40.5
40			46.5
50	M8	12.5 to 15.5	54.5
63			68.5

Allowable Kinetic Energy

⚠ Caution

Load mass and a maximum speed must be within the ranges shown in the graph below.

MGPW with Rubber Bumper

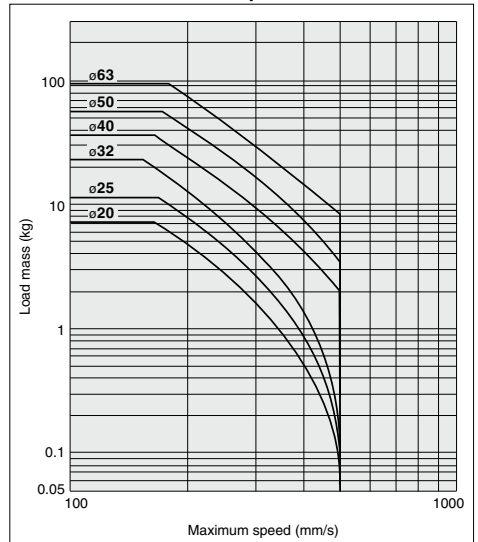

Other

⚠ Caution

Do not use this cylinder as a stopper.