

Stroke Reading Rodless Cylinder with Brake

ML2B Series

ø25, ø32, ø40

RoHS

The Controller CEU2/CEU2P series
will be discontinued in November 2019.

CEP1

CE1

CE2

ML2B



Transfer

Position feedback

**Rodless cylinder
With brake**

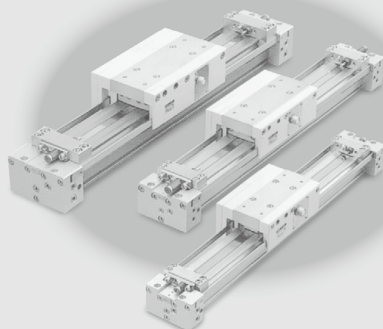

D-□

-X□

Stroke Reading Rodless Cylinder with Brake

A mechanically jointed rodless cylinder with an added brake mechanism and stroke sensor

Brake mechanism

Employs a combination spring and pneumatic lock type.

The cylinder position will be held by spring force when air pressure is absent.

The brake mechanism gives no direct load on the cylinder.

Spring force acts directly on the brake shoes to hold the brake disk; therefore, the table can be stopped without affecting the cylinder performance.

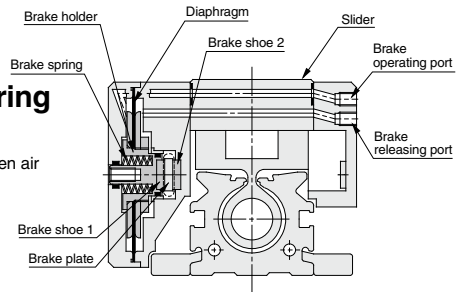

Manual release is possible.

Locking in both directions is possible.

Locking in either side of cylinder stroke is possible, too.



Rodless cylinder

A variety of piping port locations gives high-freedom on machine design. (Operation air)

Side piping
(Using elbow speed controller)

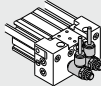

Side piping
(Using in-line speed controller)

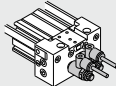

Bottom side piping

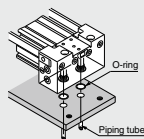

Front piping
(Using elbow speed controller)

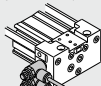

Front piping
(Using in-line speed controller)

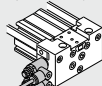

Easy Installation and Space-saving

Top mounting

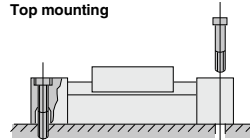

Bottom mounting

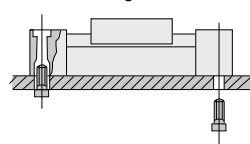

ML2B Series

∅25, ∅32, ∅40

Measuring

Smallest measuring unit 0.1 mm/Pulse

Measured with the scale plate with a sensing head built into the body.

Relation between Displacement and Output Pulse on Stroke Reading Cylinder

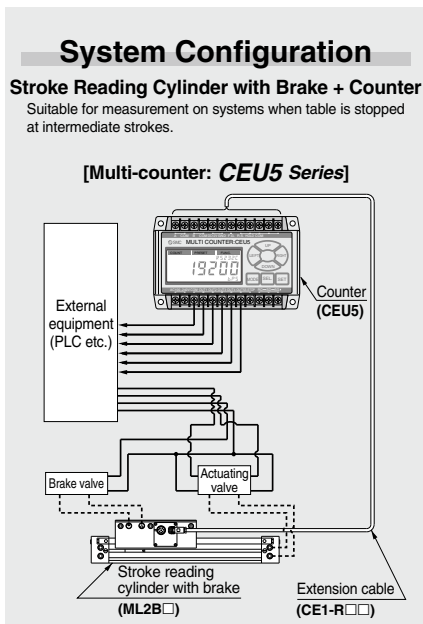
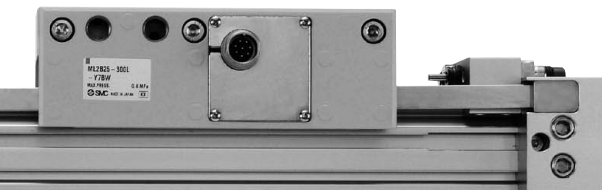
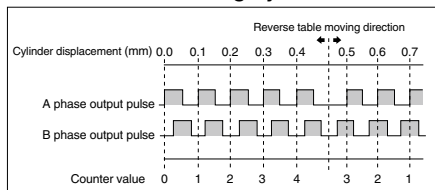

CEP1
CE1
CE2
ML2B

Dust protection

A special lip shaped side scraper installed on the bottom side of slide table prevents dust from entering.

Auto switches can be recessed in the body.

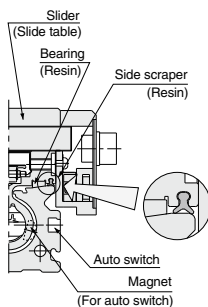

Stroke adjustment unit, integrated shock absorber and stopper bolt.

Stroke adjustment is possible.
Shock absorber is self adjusting for changing load demands.

D-□
-X□

ML2B Series Prior to Use

* This series cannot be used in an environment where it is exposed to fluids (water, oil, coolant, etc.)

System Checking Flow Chart

By integrating a directional control valve, a brake valve, and a stroke reading rodless cylinder with brake, precise stopping at any designated point is possible.

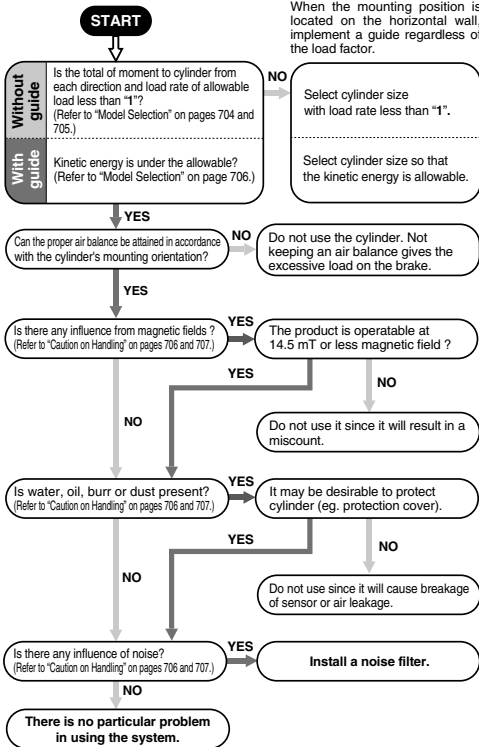

Model Selection

Maximum allowable load weight and allowable moment will vary depending on workpiece mounting methods, mounting orientation and piston speed. A determination of usability is performed based on the operating limit values in the graphs with respect to operating conditions, but the total ($\sum \alpha n$) of the load factors (αn) for each weight and moment should not exceed 1. Besides, if it is used for positioning, maximum speed that can be achieved shall be 500 mm/s or less.

For details, refer to either "Instruction manual for positioning system with brake (rodless type)" or "Instruction manual for Stroke Reading Rodless Cylinder with Brake".

Load Weight

Load weight (kg)

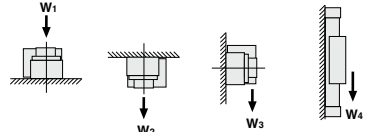

Maximum Load Weight (kg)

Model	W ₁	W ₂	W ₃	W ₄
ML2B25	20.4	4.8	4.4	10.2
ML2B32	30.6	6.5	7.3	15.3
ML2B40	51.0	8.1	11.5	25.5

Moment

Allowable Moment (N·m)

Model	Pitch moment	Roll moment	Yaw moment
	M ₁ /M _{1e}	M ₂	M ₃ /M _{3e}
ML2B25	10	1.2	3.0
ML2B32	20	2.4	6.0
ML2B40	40	4.8	12

Static Moment

Moment generated by the workpiece mass even when the cylinder is stopped

■ Pitch moment

$$M_1 = W_1 \times L_1$$

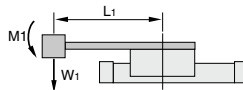

$$M_1 = W_4 \times L_3$$

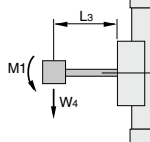

■ Roll moment

$$M_2 = W_3 \times L_3$$

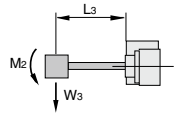

$$M_2 = W_1 \times L_2$$

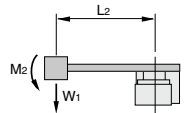

■ Yaw moment

$$M_3 = W_4 \times L_2$$

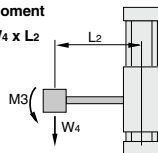

Maximum Load Weight/Allowable Moment (Not using external guide)

$$\text{The sum of the load rate } \Sigma \alpha_n = \frac{\text{Load weight [kg]}}{\text{Maximum load weight [Wmax]}} + \frac{\text{Static moment [M]}}{\text{Allowable static moment [Mmax]}} + \frac{\text{Dynamic moment [Me]}}{\text{Allowable dynamic moment [Memax]}} \leq 1$$

Wmax, Mmax, Memax from below graphs.

ML2B/W₁

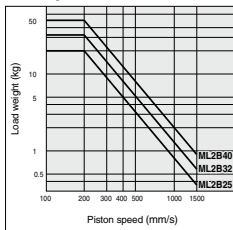

ML2B/W₂

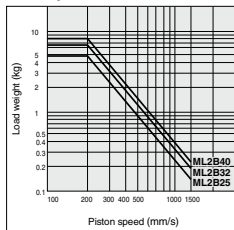

ML2B/W₃

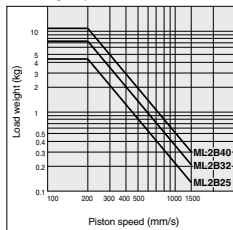

ML2B/W₄

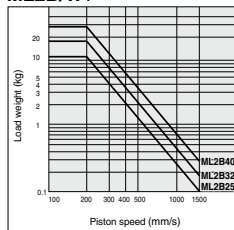

ML2B/M₁ (Pitch moment)

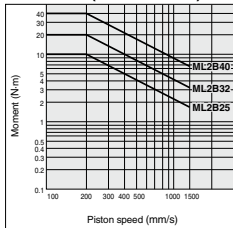

ML2B/M₂ (Roll moment)

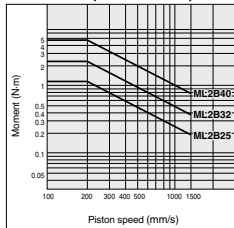

ML2B/M₃ (Yaw moment)

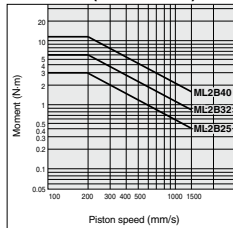

Dynamic Moment

Moment generated by impact load at stroke end

■ Pitch moment

$$M_{1e} = W_e \times L_3 \times \frac{1}{3}$$

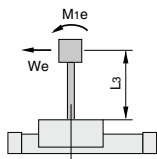

■ Yaw moment

$$M_{3e} = W_e \times L_2 \times \frac{1}{3}$$

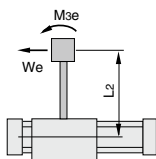

■ Reference formula [Dynamic moment at impact]

Use the following formula to calculate dynamic moment when shock for stopper collision impact is taken into consideration.

- m : Load mass (kg)
- F : Load (N)
- FE : Load equivalent to impact (at impact with stopper) (N)
- Ua : Average speed (mm/s)
- M : Static moment (N·m)
- U : Collision speed (mm/s)
- L1 : Distance to the center of load gravity (m)
- ME : Dynamic moment (N·m)
- g : Gravitational acceleration (9.8 m/s²)

$$U = 1.4U_a \text{ (mm/s)} \quad F_E = \frac{1.4}{100} U_a \cdot g \cdot m$$

$$\therefore M_E = \frac{1}{3} \cdot F_E \cdot L_1 = 0.05U_a \cdot m \cdot L_1 \text{ (N·m)}$$

Note) Average load coefficient (This coefficient is meant to average the maximum load moment at the time of impact with stopper in the light of calculating the service life.)

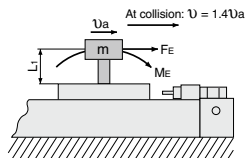

CEP1

CE1

CE2

ML2B

D-□

-X□

ML2B Series Prior to Use

Model Selection Allowable Kinetic Energy (With external guide)

Allowable kinetic energy

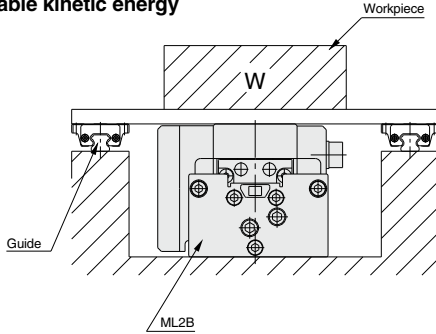

Type	ML2B25	ML2B32	ML2B40
Allowable kinetic energy (J)	0.43	0.68	1.21

- The piston speed will exceed the average speed immediately before locking. To determine the piston speed for the purpose of obtaining the kinetic energy of load, use 1.4 times the average speed as a guide.
- The relation between the speed and the load of the respective tube bores is indicated in the diagram on the right. Use the cylinder in the range below the line.
- Locking mechanism has to absorb not only kinetic energy of pay load but also thrust energy of cylinder when locking. Accordingly, to secure braking force there is a certain limit for pay load despite being within allowable kinetic energy. In the case of horizontal orientation, the solid line is the load limit. In the case of vertical orientation, the dotted line is the load limit.

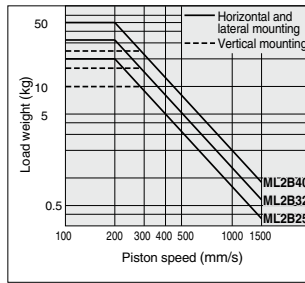

Handling of Technical Material

- For further positioning system, refer to "Instruction manual for positioning system with brake (rodless type)".
- For further cylinder information, refer to "Instruction manual for Stroke Reading Rodless Cylinder with Brake".

Caution on Handling

Pneumatic Circuit Design

1. Operating pneumatic circuit [Horizontal and lateral mounting]

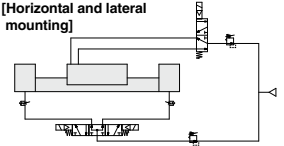

[Vertical mounting]

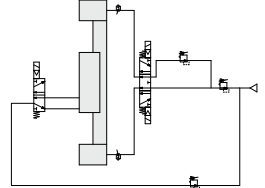

	SOL. 1	SOL. 2	SOL. 3
A	ON	OFF	ON
B	OFF	ON	ON
Stop	OFF	OFF	OFF

2. Solenoid valve for driving and braking

	Horizontal and lateral mounting	Vertical mounting
Solenoid valve for driving	VFS25□□	VFS24□OR
Solenoid valve for braking	VFS21□□	
Regulator	AR425	
Piping size	ML2B25, 32	Bore size ø4 or more
	ML2B40	Bore size ø5 or more

3. Piping

Piping length between cylinder ports and solenoid valve for driving should be less than 50 cm. When using system with brake, piping length between solenoid valve for braking and brake supply port should be less than 1 m. If longer, the brake function may be delayed when the cylinder position is held, for emergency stops or cylinder may eject at brake release.

4. Air balance

Air balance on both pneumatic circuits mentioned above is made by supplying air pressure, to both sides of the piston when at intermediate stop. When mounting vertically the balance of load is kept by a regulator (1) decreases up-stream pressure. Use caution the piston rod may be lurched when the next motion gets started after the intermediate stops or commence the operation after the reverse motion gets done, unless the air balance is taken. It may result in degrading its accuracy.

5. Supply pressure

Set supply pressure 0.3 to 0.5 MPa to brake release port.

When supply pressure is below 0.3 MPa brake may not be released, when it is over 0.5 MPa brake life may be shortened. If line pressure is used directly as supply pressure, any fluctuation in pressure will appear in the form of changes in cylinder characteristics. Therefore, make sure to use a pressure regulator to convert line pressure into supply pressure for the solenoid valve for driving and the solenoid valve for braking. In order to actuate multiple cylinders at once, use a pressure regulator that can handle a large air flow volume and also consider installing an air tank.

Mounting

1. Position detecting sensor

Stroke reading rodless cylinder with brake is a magnetic type sensor. Strong magnetic fields around the sensor will cause a malfunction. External magnetic fields should be less than 14.5 mT or less.

A magnetic field of 14.5 mT is equivalent to a position that has about 18 cm radius from a welded part using about 15,000 amperes of welding amperage. When using it in a stronger magnetic field, cover the sensor with magnetic and shield it.

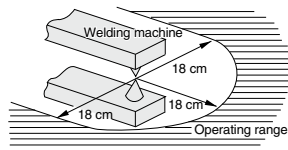

Avoid applications where the cylinder is in direct contact with water and oil, etc.

2. Noise

When stroke reading hy-rodless cylinder with brake is used in an atmosphere with electrical noise from a motor, welding machine, miscount is created by this noise. To prevent this, the noise source and wiring should be separated from power wire. Maximum transmitted distance for stroke reading rodless cylinder with brake is 20 m. Be sure not to exceed this wire length.

3. Mounting

Flush piping thoroughly before connection in order to prevent dust or chips from entering the cylinder.

Take care not to score slide surface of the cylinder tube. This may damage the bearing and scraper, resulting in malfunctioning of the cylinder.

Take care not to apply a strong impact or excessive moment to the table when loading a workpiece as slide table is supported by bearing made of resin.

4. Piping

Piping connection to head covers can be selected according to application. Bottom piping is effective for high density designed equipment and machines since piping does not come out from the mounting surface. (Below fig.: Refer to piping port variation.)

Using

- When a stroke reading hy-rodless cylinder with brake is connected to load with an external support mechanism, accurate alignment is required even if the ML2B can be used with direct load within the allowable range. If stroke is longer, axis alignment deflection will be greater; therefore, install floating mechanism to absorb deflection. This actuator can be used without lubrication. However, if it is lubricated, use turbine oil Class 1 (ISO VG32). (Do not use machine oil or spindle oil.)
- Cover the cylinder when it is used in an environment where cutting dust, powder (paper powder, thread yarn, etc.) and cutting oil (gas oil, water, warm water, etc.) present.
- We recommend that grease be regularly applied to bearing (slide part) and dust seal band as it may extend the service life.
- Brake and scale plates should be protected from load and external force which may cause malfunction. Do not apply load and external force on brake and scale plate. Readjustment for brake and scale plates in normal operating condition is not necessary due to preadjustment prior to delivery. Therefore, do not change the setting on adjustment parts carelessly.

CEP1
CE1
CE2
ML2B

Operating

1. Positioning at cylinder stroke end

Stable stop accuracy at end of stroke positioning is not obtained due to large speed change from cushion influence. Therefore, positioning position must not be within cushion stroke. (Refer to cushion stroke table.)

2. System with counter

Counter response speed is generally called "counting speed". If cylinder with brake is faster than "counting speed" in counter, the counter will make a reading error and miss-counting occurs.

Use CEU5.
Cylinder speed < "Counting speed" in counter
(Cylinder speed 500 mm/s is equivalent to 5 kcps of "counting speed" in counter.)

- Ejection from jumping at beginning of extend or retract stroke may cause temporarily high speeds exceeding the response speed "counting speed" in the counter or position detection sensor. This can be a cause of malfunction.

Piping port variation

No. of piping surface	①	②	③	④	⑤	⑥
Head cover	Head cover WL			Head cover WR		
Piping surface	Front	Side	Bottom	Front	Side	Bottom
Operating direction	Left	A	C	E	G	I
	Right	B	D	F	H	J
						L

Note 1) The 6 types of centralized piping shown above are available in centralized piping model.
 Note 2) SMC speed controller with One-touch fitting can be directly mounted on piping surface 1, 2, 4 and 5.
 Note 3) When connected to the CEU5

Handling

1. Do not generate negative pressure in the cylinder tube.

Take precautions under operating conditions in which negative pressure is generated

inside the cylinder by external forces or inertial forces. Air leakage may occur due to separation of the seal belt.

D-□
-X□

Stroke Reading Rodless Cylinder with Brake

ML2B Series

∅25, ∅32, ∅40



The Controller CEU2/CEU2P series was discontinued in November 2019. Please contact your local sales representative for more details.

How to Order

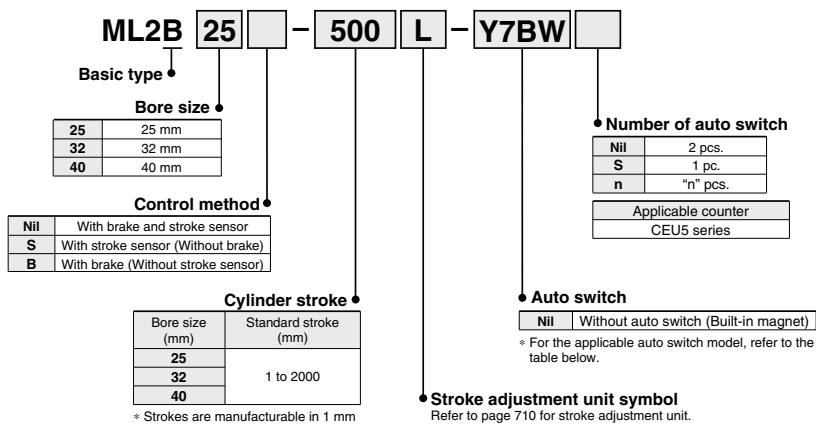

CEP1
CE1
CE2
ML2B

Applicable Auto Switches

Refer to pages 941 to 1067 for further information on auto switches.

Type	Special function	Electrical entry	Indicator	Wiring (Output)	Load voltage		Auto switch model		Lead wire length (m)*			Pre-wired connector	Applicable load	
					DC	AC	Electrical entry direction	In-line	0.5 (Nil)	3 (L)	5 (Z)			
Solid state auto switch	—	Grommet	Yes	3-wire (NPN)	24 V	5 V, 12 V	—	Y69A	Y59A	●	●	○	IC circuit	Relay, PLC
				3-wire (PNP)				Y7PV	Y7P	●	●	○		
				2-wire	Y69B	Y59B	●	●	○					
	Diagnostic indication (2-color indicator)			3-wire (NPN)	24 V	5 V, 12 V	—	Y7NWV	Y7NW	●	●	○	IC circuit	
				3-wire (PNP)				Y7PWV	Y7PW	●	●	○		
				2-wire	Y7BWV	Y7BW	●	●	○					
Reed auto switch	—	Grommet	Yes	3-wire (NPN equivalent)	—	5 V	—	—	Z76	●	●	—	IC circuit	—
				2-wire	24 V	12 V	100 V	—	Z73	●	●	●	—	Relay, PLC
						100 V or less	—	Z80	●	●	—	IC circuit		

* Lead wire length symbols: 0.5 m Nil (Example) Y7BW
 3 m L (Example) Y7BWL
 5 m Z (Example) Y7BWZ

- * Solid state auto switches marked with "○" are produced upon receipt of order.
- * For details about auto switches with pre-wired connector, refer to pages 1014 and 1015.
- * Normally closed (NC = b contact) solid state auto switches (D-Y7G/Y7H types) are also available. Refer to page 961 for details.
- * Auto switches are shipped together (not assembled).

D-□
-X□

ML2B Series



Cylinder Specifications

Bore size (mm)		25	32	40
Fluid		Air		
Action	Cylinder	Double acting		
	Brake	Spring and pneumatic		
Operating pressure range	Cylinder	0.1 to 0.8 MPa		
	Brake	0.3 to 0.5 MPa		
Proof pressure	Cylinder	1.2 MPa		
	Brake	0.75 MPa		
Ambient and fluid temperature		5 to 60°C (No freezing)		
Piston speed		100 to 1500 mm/s (During the positioning 100 to 500 mm/s)		
Cushion		Air cushion on both sides		
Lubrication		Non-lube		
Stroke tolerance (mm)		0 to 1.8		
Piping port size	Front/Side ported	Rc 1/8		Rc 1/4
	Bottom ported	ø5	ø6	ø8

As for multi counter, it will be common to CEP1 and CE1 series. For details, Multi counter/CEU5 on page 667 respectively.

Sensor Specifications

Maximum transmission distance	20 m (In the case of using our cable as well as our controller or counter.)
Position detection method	Incremental type
Magnetic field resistance	14.5 mT
Power supply	10.8 to 13.2 VDC (Ripple 1% or less)
Current consumption	40 mA
Resolution	0.1 mm/pulse
Accuracy	±0.2 mm ^{Note)} (at 20°C)
Output type	NPN open collector (35 VDC, 80 mA)
Output signal	A/B phase difference output
Insulation resistance	50 MΩ or more (500 VDC measured via megohmmeter) (between case and 12E)
Vibration resistance	33.3 Hz, 2 hours at X, Y and 4 hours at Z JIS D 1601 as standard
Impact resistance	30 G, 3 times at X, Y, Z
Enclosure	IP50 (IEC standard)
Extension cable (Option)	5 m, 10 m, 15 m, 20 m Cable: ø7; 6 core twisted pair shielded wire; oil, heat and flame resistant cable

Note) Digital error under Counter (CEU5) is included. Besides, the whole accuracy after mounting on an equipment may be varied depending on the mounting condition and surroundings. As an equipment, calibration should be done by customer.

Stroke Adjustment Unit Specifications

Applicable bore size (mm)		25	32	40
Unit symbol		L		L
Configuration	Shock absorber model	RB1007 + with adjustment bolt	RB1412 + with adjustment bolt	RB1412 + with adjustment bolt
Stroke adjustment range by intermediate fixing spacer (mm)	Without spacer	0 to -11.5	0 to -12	0 to -16
	With short spacer	-11.5 to -23	-12 to -24	-16 to -32
	With long spacer	-23 to -34.5	-24 to -36	-32 to -48

* Stroke adjustment range is applicable for one side when mounted on a cylinder.

* The shock absorber service life is different from that of the ML2B cylinder depending on operating conditions. Refer to the RB Series Specific Product Precautions for the replacement period.

Stroke Adjustment Unit Symbol

		Right side stroke adjustment unit				
		Without unit	L: With low load shock absorber + Adjustment bolt		With short spacer	With long spacer
Left side stroke adjustment unit	Without unit	Nil	SL	SL6	SL7	
	L: With low load shock absorber + Adjustment bolt	LS	L	LL6	LL7	
	With short spacer	L6S	L6L	L6	L6L7	
	With long spacer	L7S	L7L	L7L6	L7	

Stroke adjustment unit mounting diagram

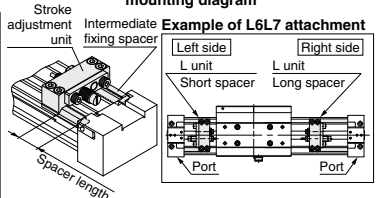

Shock Absorber Model

Model	ø25	ø32	ø40
	RB1007	RB1412	RB1412

Shock Absorber Specifications

Applicable bore size (mm)		25	32	40
Shock absorber model		RB1007	RB1412	RB1412
Maximum energy absorption (J)		5.9	19.6	19.6
Stroke absorption (mm)		7	12	12
Maximum collision speed (mm/s)		1500	1500	1500
Maximum operating frequency (cycle/min)		70	45	45
Spring force (N)	Extended	4.22	6.86	6.86
	Retracted	6.86	15.98	15.98
Operating temperature range (°C)		5 to 60		

Theoretical Output

Bore size (mm)	Piston area (mm ²)	Operating pressure (MPa)						
		0.2	0.3	0.4	0.5	0.6	0.7	0.8
25	490	98	147	196	245	294	343	392
32	804	161	241	322	402	483	563	643
40	1256	251	377	502	628	754	879	1005

Note) Theoretical output (N) = Pressure (MPa) x Piston area (mm²)

Weight

Bore size (mm)	Basic weight	Additional weight per each 50 mm of stroke	Side support weight (per set)		Stroke adjustment unit weight (per unit)
			Type A	Type B	
25	2.89	0.142	0.015	0.016	0.10
32	4.75	0.199	0.015	0.016	0.21
40	6.87	0.290	0.040	0.041	0.32

Option

Stroke adjustment unit model

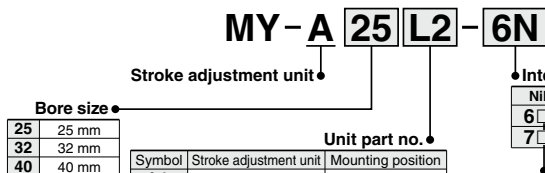

Note) Refer to page 710 for details of adjustment range.

Intermediate fixing spacer

Nil	Without spacer
6	Short spacer
7	Long spacer

Spacer shipping method

Nil	Assembled as a unit
N	Spacer only

- Spacers are used to fix the stroke adjustment unit at an intermediate stroke position.
- Spacers are shipped in 2 piece sets.

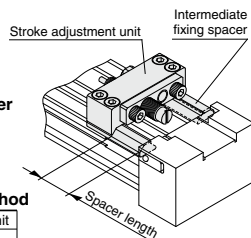

Component Parts

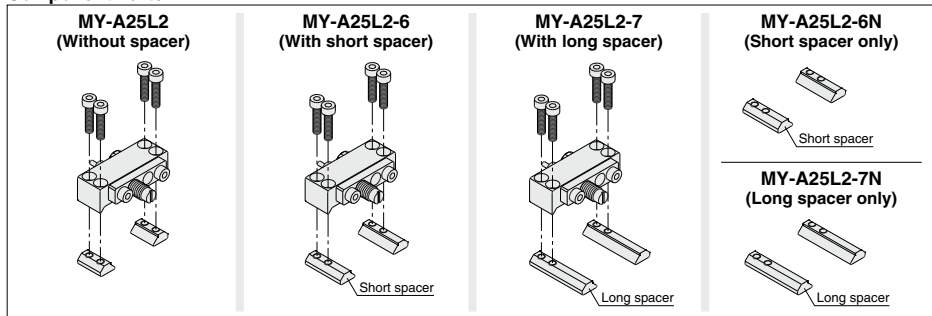

Side Support Part No.

Type	Bore size (mm)		
	25	32	40
Side support A	MY-S25A	MY-S32A	MY-S32A
Side support B	MY-S25B	MY-S32B	MY-S32B

For details about dimensions, etc., refer to page 718.

CEP1

CE1

CE2

ML2B

D-□

-X□

ML2B Series

Brake Capacity

Holding Force of Spring Locking (Maximum static load)

Bore size (mm)	25	32	40
Holding force	245 N	400 N	628 N

Note) The holding force is the lock's ability to hold a static load that does not involve vibrations or impacts, when it is locked without a load.

- Therefore, when normally using the cylinder near the upper limit of the holding force, be aware of the points described below.
- Select the cylinder bore size so that the load is less than 80% of the holding force.
 - If the piston rod slips because the lock's holding force has been exceeded, the brake shoe could be damaged, resulting in a reduced holding force or shortened life.

Holding Force of Locking for Pneumatic and Spring

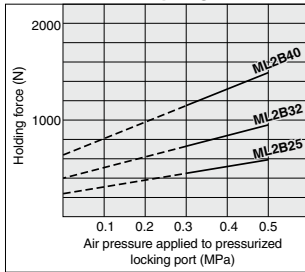

Stopping Accuracy

When the cylinder is stopped at intermediate strokes by PLC and erratic stopping positions appear. Check piston speed, load, piping conditions, control method, etc. Use values on the table below as reference.

ML2B + PLC

Piston speed (mm/s)	100	300	500	800	1000
Stopping accuracy (mm)	±0.5	±1.0	±2.0	±3.0	±4.0

Condition/Driving pressure: 0.5 MPa
 Brake releasing pressure: 0.3 MPa
 Load factor: 25%
 (Solenoid valve for brake releasing is connected to the cylinder directly and the dispersion of control system is not included.)

Overrun (ML2B + PLC)

When cylinder is stopped at intermediate strokes, "idle running distance" is from the detection of stop signal to beginning of brake operation and "braking distance" is from beginning of brake operation to stop of slider.

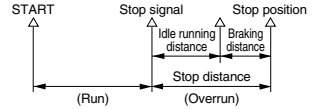

The graph below shows the piston speed and overrun reference values. (The length of overrun is changed dependent on piston speed, load, piping condition and control method. Be sure to adjust the stop signal position, etc. by trial operation with the actual machine.)

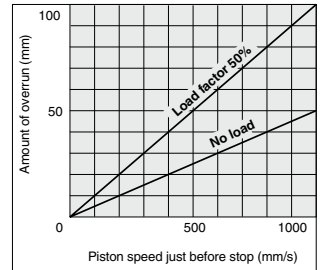

Condition/Driving pressure: 0.5 MPa
 Brake releasing pressure: 0.3 MPa
 Mounting orientation: Horizontal

Working Principle of Brake Mechanism

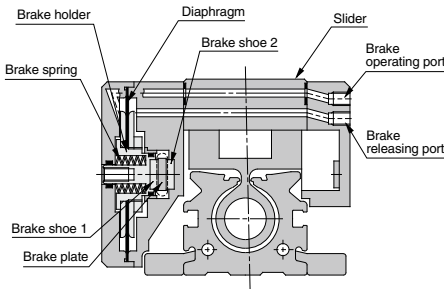

Anatomy of brake operation

Spring force generated by the brake spring and the air pressure supplied to brake operating port work on brake shoe 1 fixed to the brake holder, bend brake plate fixed on head cover on both sides, and stop slider by putting brake plate between brake shoe 1 and brake shoe 2 fixed on the slider side.

Brake release

The air pressure supplied to the brake releasing port acts on a diaphragm, extending the brake spring, and canceling the brake.

Manual Operation

[Brake releasing]

1. Supply brake releasing pressure of 0.3 to 0.5 MPa to brake releasing port on slider side.
2. Screw on appropriate hexagon socket head bolt into manual port on slide side.
3. Exhaust brake releasing air.

[Brake operation]

1. Supply brake releasing pressure of 0.3 to 0.5 MPa to brake releasing port on slider side.
2. Remove the bolt threaded into manual port.
3. Exhaust brake releasing air.

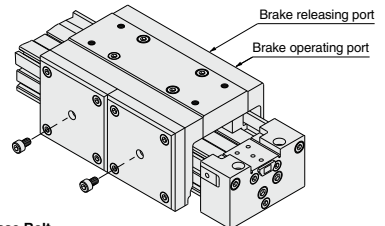

Manual Release Bolt

ML2B25	M5 x 0.8	L = 8
ML2B32	M6 x 1	L = 10
ML2B40	M8 x 1.25	L = 12

Note) Screw in after attaching a washer in the hexagon socket head cap bolt.

Cushion Capacity

Cushion Selection

<Air cushion>

Stroke reading hy-rodless cylinder with brake is equipped with a standard air cushion.

The air cushion mechanism is incorporated to prevent excessive impact of the piston at the stroke end during high speed operation. The purpose of air cushion, thus, is not to decelerate the piston near the stroke end.

The weight and speed ranges that the air cushion can absorb are shown within the limit lines on the graph.

<Stroke adjusting unit with shock absorber>

Use this unit to decelerate the cylinder when weight and speed are beyond the air cushion limit lines or when the stroke adjustment causes limited or no cushion engagement.

⚠ Caution

- The absorption capacity of each unit shown here is given for the mounted shock absorber when used at full stroke. When the effective stroke of the absorber decreases as a result of stroke adjustment, the absorption capacity becomes extremely small. Fix the adjusting bolt to around 0.5 mm projection from the shock absorber as shown below.

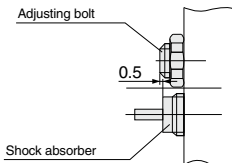

- When the shock absorber is used within the air cushion stroke range, almost open the air cushion needle (about 1 turn from the fully closed position).

Air Cushion Stroke (mm)

Bore size (mm)	Cushion stroke
25	15
32	19
40	24

Service Life and Replacement Period of Shock Absorber

⚠ Caution

- Allowable operating cycle under the specifications set in this catalog is shown below.**

2 million cycles: RB1007, RB1412

Note) Specified service life (suitable replacement period) is the value at room temperature (20 to 25°C). The period may vary depending on the temperature and other conditions. In some cases the absorber may need to be replaced before the allowable operating cycle above.

Bore size (mm)	Shock absorber model
25	RB1007
32	RB1412
40	RB1412

Absorption Capacity of the Air Cushion and Stroke Adjusting Unit

ML2B25

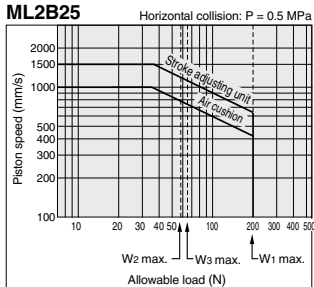

ML2B32

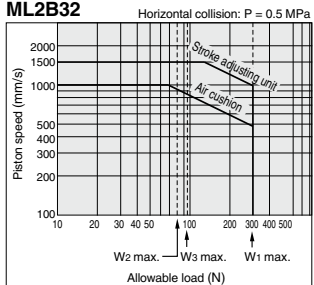

ML2B40

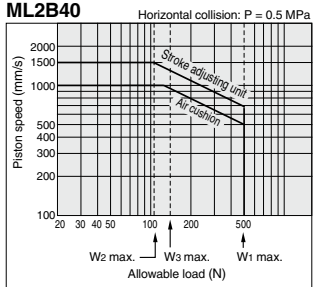

Tightening Torque for Stroke Adjusting Unit Lock Plate Holding Bolts (N·m)

Bore size (mm)	Tightening torque
25	3
32	5
40	10

Tightening Torque for Stroke Adjusting Unit Lock Plate Holding Bolts (N·m)

Bore size (mm)	Tightening torque
25	1.2
32	3.3
40	3.3

Calculation of Absorbed Energy for Stroke Adjusting Unit with Shock Absorber (N·m)

Type of impact	Horizontal collision	Vertical collision (Downward)	Vertical collision (Upward)
Kinetic energy E_1	$\frac{1}{2} m \cdot U^2$		
Thrust energy E_2	$F \cdot s$	$F \cdot s + m \cdot g \cdot s$	$F \cdot s - m \cdot g \cdot s$
Absorbed energy E	$E_1 + E_2$		

Symbol

U: Speed of impact object (m/s) m: Weight of impact object (kg)

F: Cylinder thrust (N) g: Gravitational acceleration (9.8 m/s²)

s: Shock absorber stroke (m)

Note) The speed of the impact object is measured at the time of impact with the shock absorber.

Adjusting Procedure

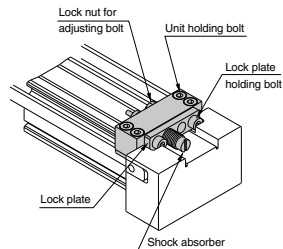

<Movement and location of stroke adjustment>

The unit body can be moved after the four unit holding bolts are loosened and can be fixed at any position by uniformly tightening the four unit holding bolts. However, there is a possibility that the adjustment mechanism will be tilted due to high impact energy.

Since the holder mounting bracket for adjustment is available as an option for -X416, -X417, we recommend that you use it. If any other length is desired, please consult with SMC. (Refer to "Tightening Torque for Stroke Adjusting Unit Holding Bolts".)

<Stroke adjustment of the adjusting bolt>

Loosen the lock nut of the adjusting bolt, adjust the stroke from the lock plate side using a wrench, then re-tighten it.

<Adjustment of shock absorber>

Loosen the two lock plate holding bolts, turn the shock absorber and adjust the stroke. Then, uniformly tighten the lock plate holding bolts and secure the shock absorber. Take care not to over-tighten the holding bolts.

(Refer to "Tightening Torque for Stroke Adjusting Unit Lock Plate Holding Bolts".)

Note)

Although the lock plate may slightly bend due to tightening of the lock plate holding bolt, this does not affect the shock absorber and locking function.

CEP1

CE1

CE2

ML2B

D-□

-X□

ML2B Series

Construction

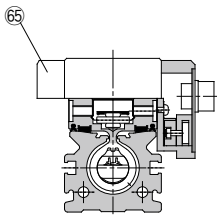
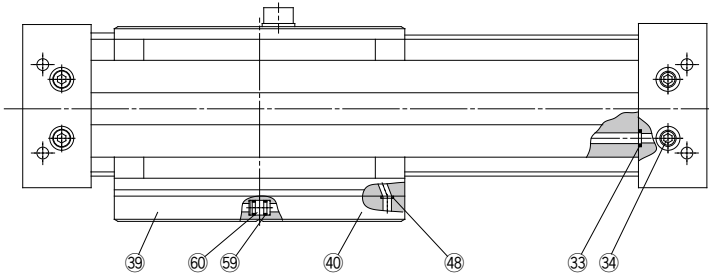
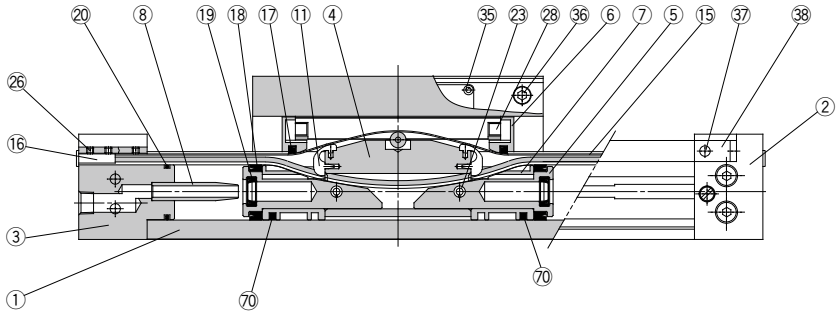

ML2B□S

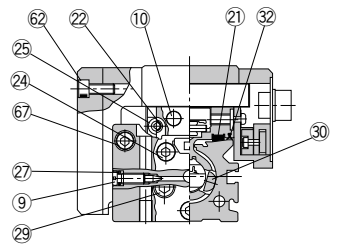
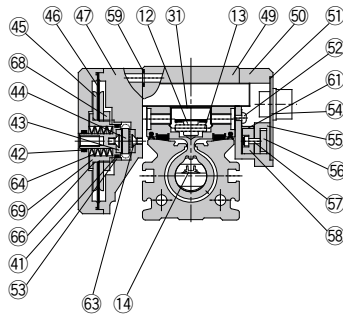

Component Parts

No.	Description	Material	Qty.	Note
1	Cylinder tube	Aluminum alloy	1	Hard anodized
2	Head cover WR	Aluminum alloy	1	Hard anodized
3	Head cover WL	Aluminum alloy	1	Hard anodized
4	Piston yoke	Aluminum alloy	1	Anodized
5	Piston	Aluminum alloy	2	Hard anodized
6	End cover	Special resin	2	
7	Wear ring	Special resin	2	
8	Cushion ring	Aluminum alloy	2	Anodized
9	Cushion needle	Carbon steel	2	Nickel plated
10	Stopper	Carbon steel	4	Nickel plated
11	Belt separator	Special resin	2	
12	Guide roller	Special resin	1	
13	Parallel pin	Carbon steel	1	
14	Seal belt	Special resin	1	
15	Dust seal band	Stainless steel	1	
16	Belt clamp	Special resin	2	
17	Scraper	NBR	2	
18	Piston seal	NBR	2	
19	Cushion seal	NBR	2	
20	Tube gasket	NBR	2	
21	Bearing	Special resin	2	
22	Spacer	Stainless steel	4	
23	Spring pin	Carbon tool steel	2	
24	Hexagon socket head cap screw	Carbon tool steel	6	Chromated
25	Hexagon socket button head screw	Carbon tool steel	4	Chromated
26	Hexagon socket head set screw	Carbon tool steel	8	Chromated
27	O-ring	NBR	2	
28	Double round parallel key	Carbon steel	2	
29	Hexagon socket head taper plug	Carbon steel	6	Chromated
30	Magnet	—	2	
31	Top cover	Stainless steel	1	
32	Side scraper	Special resin	2	
33	O-ring	NBR	4	
34	Hexagon socket head taper plug	Carbon steel	4	Chromated
35	Phillips truss head screw	Carbon steel	4	Chromated
36	Hexagon socket head cap screw	Carbon steel	3	Chromated
37	Parallel pin	Stainless steel	4	
38	Tension plate	Carbon steel	4	Nickel plated
39	Side cover L	Aluminum alloy	1	Hard anodized
40	Side cover R	Aluminum alloy	1	Hard anodized
41	O-ring	NBR	2	
42	O-ring	NBR	2	
43	Brake shoe	Sintered metallic	4	
44	Brake plate	Stainless steel	1	Hard chrome plated
45	Diaphragm shell	Stainless steel	4	
46	Diaphragm	NBR	2	
47	Brake body	Aluminum alloy	1	Hard anodized
48	O-ring	NBR	1	
49	Slide table	Aluminum alloy	1	Hard anodized
50	Sensor body	Aluminum alloy	1	Chromated
51	Connector gasket	NBR	1	
52	Round head Phillips screw	Carbon steel	2	Chromated
53	Brake guide	Carbon steel	2	Gas soft treated
54	Connector cover ^A _B	Carbon steel	1	Chromated
55	Sensor guide	Sintered metallic	1	

No.	Description	Material	Qty.	Note
56	Scale plate	Carbon steel	1	Nickel plated
57	Hexagon socket head cap screw	Carbon steel	2	Chromated
58	Sensor unit	—	1	
59	O-ring	NBR	6	
60	Joint valve	Stainless steel	1	
61	Sensor holder	Stainless steel	1	
62	Hexagon socket head cap screw	Carbon steel	8	Chromated
63	Cross recessed countersunk head screw	Carbon steel	4	Chromated
64	Brake spring	Carbon steel	2	
65	Side plate	Aluminum alloy	1	Chromated
66	O-ring	NBR	2	
67	Hexagon socket head cap screw	Carbon steel	8	Chromated
68	Diaphragm nut	Carbon steel	2	Chromated
69	Brake holder	Carbon steel	2	Gas soft treated
70	Lube-retainer	Special resin	2	

CEP1

CE1

CE2

ML2B

D-□

-X□

ML2B Series

Dimensions

Basic type

ML2B Bore size — Stroke

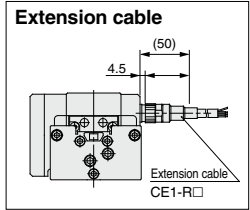
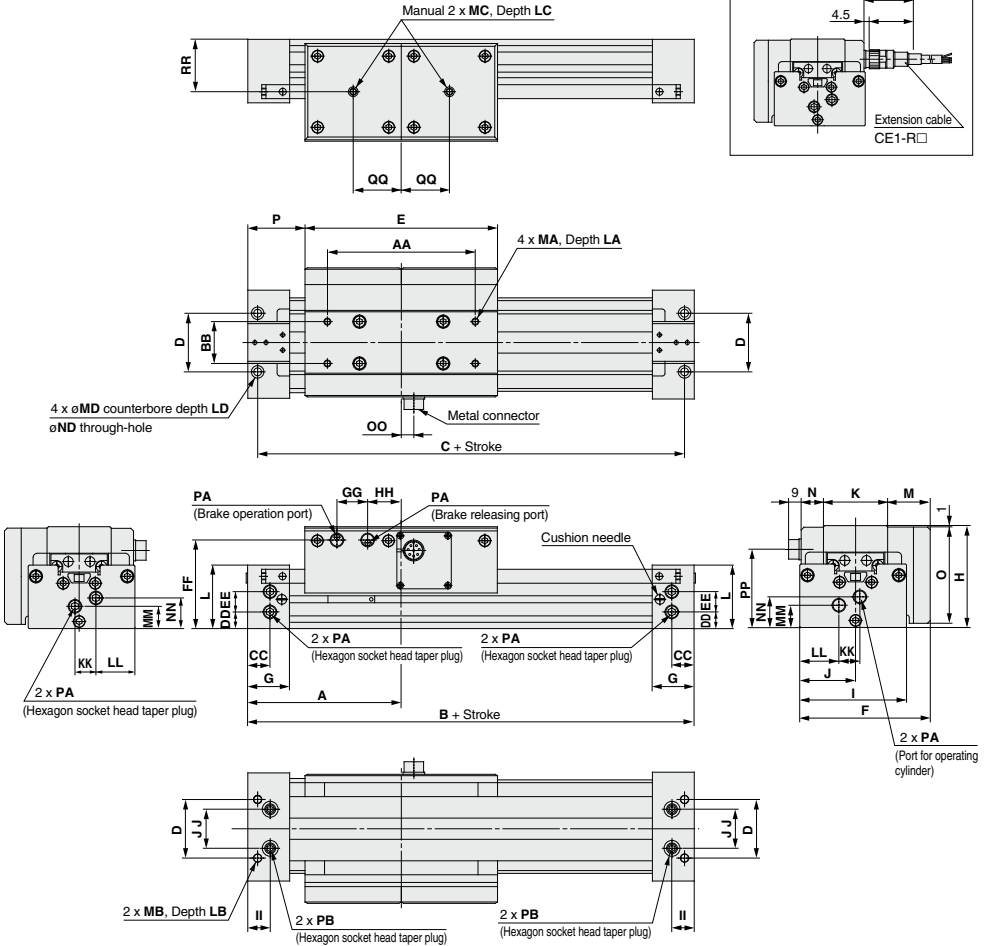

Model	A	B	C	D	E	F	G	H	I	J	K	L	M	N	O	P	AA	BB	CC	DD	EE	FF	GG	HH	II	JJ
ML2B25	110	220	206	42	138	93.5	30	73	76.5	40	46	45.5	30.9	16	69	41	106	30	16	12	14.5	63.5	22	24	16	28
ML2B32	140	280	264	51	168	107.5	37	88	91	46.5	58	54	32.4	15	84	56	133	35	19	15	16	77.5	27	32	19	32
ML2B40	170	340	322	59	204	130.5	45	106	110	55	68	64	41.5	19	102	68	164	40	23	16.5	22	95	35	37	23	36
Model	KK	LL	MM	NN	OO	PP	QQ	RR	MA	LA	MB	LB	MC	LC	MD	LD	ND	PA	PB							
ML2B25	15	28	16	22	9	56	34.5	37.5	M5 x 0.8	11	M6 x 1	9.5	M5 x 0.8	9.5	9	5.5	5.6	Rc 1/8	Rc 1/16							
ML2B32	16	30.5	21.5	26	9.8	62.5	42	45	M6 x 1	12	M8 x 1.25	16	M6 x 1	12	11	6.5	6.8	Rc 1/8	Rc 1/16							
ML2B40	17.5	37.5	24.5	37.5	23	77	51	54	M8 x 1.25	14	M10 x 1.5	15	M8 x 1.25	12	14	8.5	8.6	Rc 1/4	Rc 1/8							

With stroke sensor:

ML2B Bore size S — Stroke

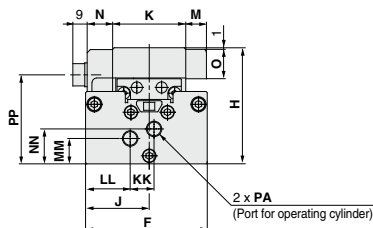

Applicable cylinder	F	H	J	K	M	N	O
ML2B25	76.5	73	40	46	13	16	18.5
ML2B32	91	88	46.5	58	15	15	19.5
ML2B40	110	106	55	68	19	19	21.5

Applicable cylinder	KK	LL	MM	NN	PA	PP
ML2B25	15	28	16	22	Rc 1/8	56
ML2B32	16	30.5	21.5	26	Rc 1/8	62.5
ML2B40	17.5	37.5	24.5	37.5	Rc 1/4	78.3

With brake:

ML2B Bore size B — Stroke

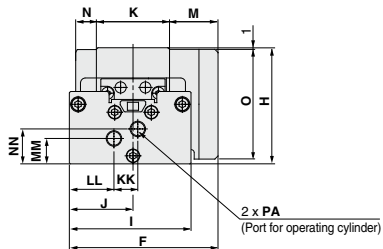

Applicable cylinder	F	H	I	J	K	M	N
ML2B25	93.5	73	76.5	40	46	30.9	16
ML2B32	107.5	88	91	46.5	58	32.4	15
ML2B40	130.5	106	110	55	68	41.5	19

Applicable cylinder	O	KK	LL	MM	NN	PA
ML2B25	69	15	28	16	22	Rc 1/8
ML2B32	84	16	30.5	21.5	26	Rc 1/8
ML2B40	102	17.5	37.5	24.5	37.5	Rc 1/4

Stroke Adjustment Unit

With shock absorber:

ML2B Bore size — Stroke L

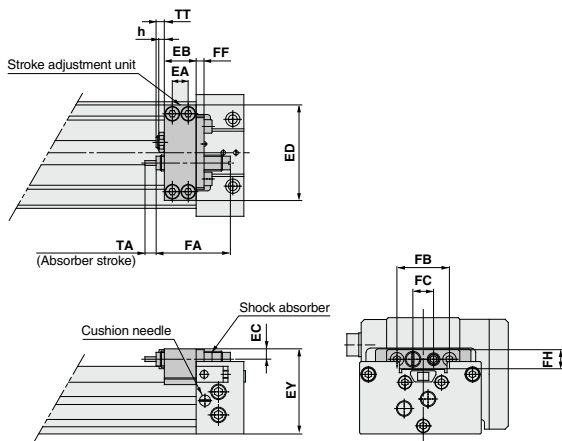

Applicable cylinder	h	EA	EB	EC	ED	EY	FA	FB	FC	FF	FH	TA	TT
ML2B25	3.5	10	20	6.5	60	53.5	46.7	33	13	6	12	7	Max. 16.5
ML2B32	4.5	12	25	8.5	74	67	67.3	43	17	6	16	12	Max. 20
ML2B40	4.5	15	31	9.5	94	81.5	67.3	43	17	6	16	12	Max. 25

CEP1

CE1

CE2

ML2B

D-□

-X□

ML2B Series

Dimensions

Side support A

MY-S□A

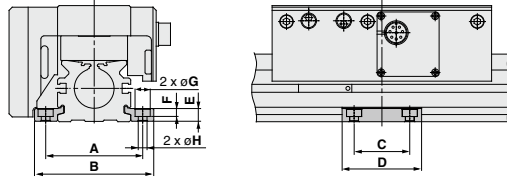

Side support B

MY-S□B

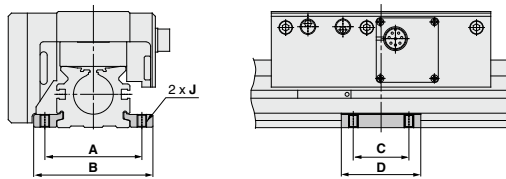

Part no.	Applicable cylinder	A	B	C	D	E	F	G	H	J
MY-S25 ^A _B	ML2B25	61	75	35	50	8	5	9.5	5.5	M6 x 1
	ML2B32	70	84							
MY-S32 ^A _B	ML2B40	87	105	45	64	11.7	6	11	6.6	M8 x 1.25

Guide for Side Support Application

For long stroke operation, the cylinder tube may be deflected depending on its own weight and the load. In such a case, use a side support in the middle section. The spacing (L) of the support must be no more than the values shown in the graph on the right.

Caution

If the cylinder mounting surfaces are not measured accurately, using a side support may cause poor operation. Therefore, be sure to level the cylinder tube when mounting.

If there is vibration, impact, etc. at long stroke, we recommend adoption of side support even if it is within the allowable value shown in the graph.

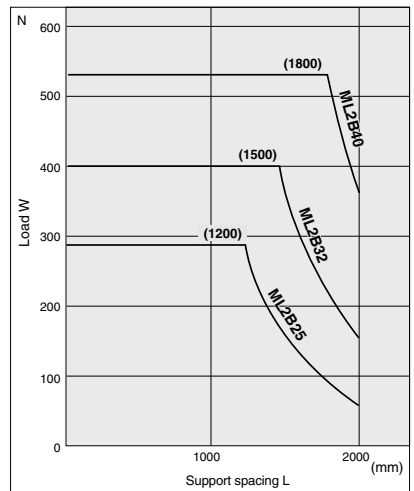
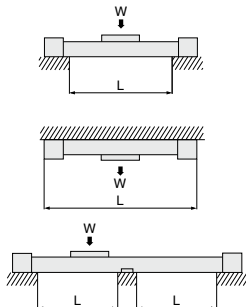

ML2B Series

Auto Switch Mounting

Auto Switch Proper Mounting Position (Detection at Stroke End)

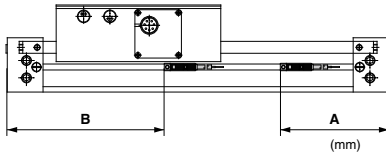

Auto switch model	Bore size (mm)	
	A	B
D-Z7□/Z80	91	131.5
D-Y59□/Y69□	102.5	180
D-Y7P/Y7PV	126.5	206
D-Y7□W/Y7□WV		

Note) Adjust the auto switch after confirming the operating conditions in the actual setting.

Caution on Handling Auto Switch

1. Always connect the auto switch to the power supply after the load has been connected.
2. Use caution not to apply excessive impact forces by dropping and bumping when handling.
3. When more than 2 cylinders with auto switches are juxtaposed, leave the distance of 40 mm or more between the cylinder tubes as shown in the below.

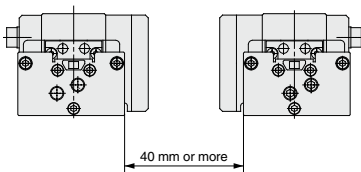

4. Avoid wiring patterns in which bending stress and pulling force are repeatedly applied to the lead wires.
5. Please consult with SMC when using in locations where water or coolant liquid, etc is splashing constantly.
6. Avoid the use in locations where the large amount of magnetism is occurring.

Operating Range

Auto switch model	Bore size (mm)		
	25	32	40
D-Z7□/Z80	8.5	11.5	11.5
D-Y59□/Y69□	6	9	10
D-Y7P/Y7PV			
D-Y7□W/Y7□WV			

* Since this is a guideline including hysteresis, not meant to be guaranteed. (assuming approximately ±30% dispersion.)
There may be the case it will vary substantially depending on an ambient environment.

Auto Switch Mounting

When mounting and securing auto switches, they should be inserted into the cylinder's auto switch mounting rail from the direction shown in the drawing below. After setting in the mounting position, use a flat head watchmaker's screwdriver to tighten the auto switch mounting screw that is included.

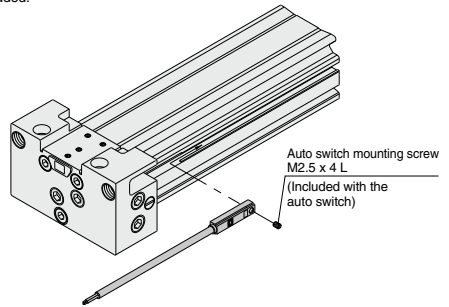

Note) When tightening an auto switch mounting screw, use a watchmaker's screwdriver with a handle of approximately 5 to 6 mm in diameter. Also, tighten with a torque of about 0.05 to 0.1 N·m. As a guide, turn about 90° past the point at which tightening can first be felt.

CEP1

CE1

CE2

ML2B

D-□

-X□

CEU Series CE Series Counter/Extension Cable



Note) CE-compliant: When connecting to a stroke reading cylinder (CE1), a high precision stroke reading cylinder (CEP1) and a stroke reading cylinder with brake (CE2), (CEU□□-D type)
Refer to the operation manual for details.



■ Multi-counter

How to Order

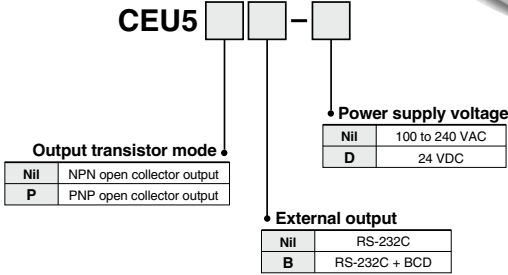

- CEP1
- CE1
- CE2
- ML2B

Connection Method

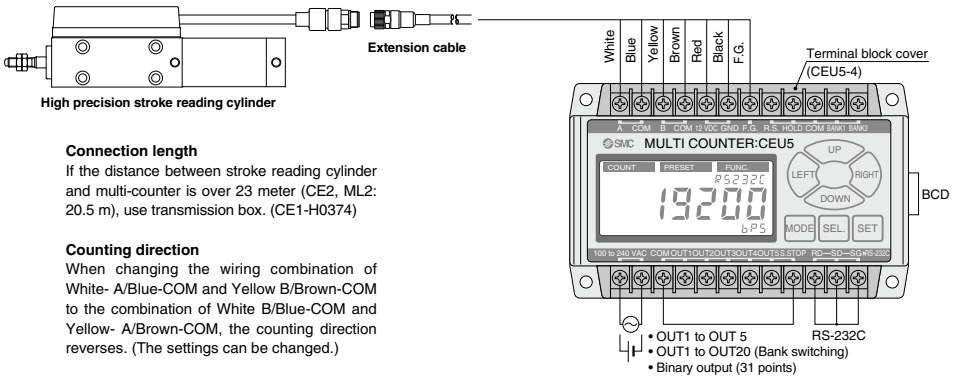

Connection length

If the distance between stroke reading cylinder and multi-counter is over 23 meter (CE2, ML2: 20.5 m), use transmission box. (CE1-H0374)

Counting direction

When changing the wiring combination of White- A/Blue-COM and Yellow B/Brown-COM to the combination of White B/Blue-COM and Yellow- A/Brown-COM, the counting direction reverses. (The settings can be changed.)

BCD output (Refer to page 676.) function is available only for CEU5□□B-□.

- (1) BCD output connector: D-Sub half pitch connector
D x 10M-36S (Made by HIROSE ELECTRIC CO., LTD.)
- (2) Applicable connectors: D x 30AM-36P (Plug: Made by HIROSE ELECTRIC CO., LTD.) *
D x 30M-36-CV (Cover: Made by HIROSE ELECTRIC CO., LTD.) *
Other interchangeable commercial cables with connectors can be also used.

* Pressure welding tools are required to connect the connector (plug, cover) models listed above and cables (order separately). The following products, including pre-assembled connectors and cables, are also available. Contact the manufacturer (Misumi Corporation) directly.
SHPT-H-A-36-*: Male connector on one end, cable cut off on one end
SHPT-HH-A-36-*: Male connectors on both ends
* 0.2 to 50 (This shows the cable length. Unit: m)

- D-□
- X□

Multi-counter/Specifications

Model	CEU5	CEU5-D	CEU5P	CEU5P-D	CEU5B	CEU5B-D	CEU5PB	CEU5PB-D
Type	Multi-counter							
Mounting	Surface mounting (DIN rail or Screw stop)							
Operating system	Adding - subtracting type							
Operation mode	Operating mode, Data setting mode, Function setting mode							
Reset system	External reset terminal							
Display system	LCD (With back light)							
Number of digits	6 digits							
Memory holding (Storage medium)	Setting value (always held), Count value (Hold/Non-hold switching), (E ² ROM (Warning display after writing approx. 800,000 times: E2FUL))							
Input signal type	Count input, Control signal input (Reset, Hold, Bank selection)							
Count input	No-voltage pulse input							
Pulse signal system	90° phase difference input *1/ UP/DOWN separate input *2							
Counting speed	100 kHz *1							
Control signal input	Voltage input (12 VDC or 24 VDC)							
Sensor power supply	10.8 to 13.2 VDC, 60 mA							
Output signal type	Preset output, Cylinder stop output				Preset output, Cylinder stop output, BCD output			
Preset output configuration	Compare/Hold/One-shot (100 ms fixed pulse)							
Output type	Separate 5 point output/Binary code output							
Output delay time	5 ms or less (for normal output)/60 ms or less (Binary output)							
Communication system	RS-232C							
Output transistor mode	NPN open collector Max 30 VDC, 50 mA		PNP open collector Max 30 VDC, 50 mA		NPN open collector Max 30 VDC, 50 mA *3		PNP open collector Max 30 VDC, 50 mA *3	
Power supply voltage	90 to 264 VAC	21.6 to 26.4 VDC	90 to 264 VAC	21.6 to 26.4 VDC	90 to 264 VAC	21.6 to 26.4 VDC	90 to 264 VAC	21.6 to 26.4 VDC
Power consumption	20 VA or less	10 W or less	20 VA or less	10 W or less	20 VA or less	10 W or less	20 VA or less	10 W or less
Withstand voltage	Between case and AC line: 1500 VAC for 1 min. Between case and signal ground: 500 VAC for 1 min.							
Insulation resistance	Between case and AC line: 50 MΩ or more (500 VDC measured via megohmmeter)							
Ambient temperature	0 to +50°C (No freezing)							
Ambient humidity	35 to 85% RH (No condensation)							
Noise resistance	Square wave noise from a noise simulator (pulse duration 1 μs) between power supply terminals ±2000 V, I/O line ±600 V							
Shock resistance	Endurance 10 to 55 Hz; Amplitude 0.75 mm; X, Y, Z for 2 hours each							
Impact resistance	Endurance 10 G; X, Y, Z directions, 3 times each							
Weight	350 g or less							

*1) 90° phase difference input

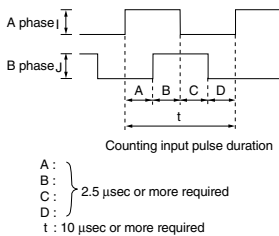

$$\text{Counting speed } f = \frac{1}{t} = \frac{1}{10 \times 10^{-6}} = 100000 \text{ Hz} \approx 100 \text{ kHz}$$

*2) UP/DOWN input

Input wave form conditions: At a maximum of 100 kHz, the UP/DOWN wave form should be as shown below.

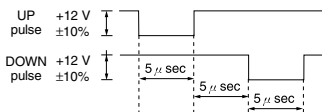

*3) 15 mA when BCD is output (Refer to page 676.)

Multi-counter/Dimensions

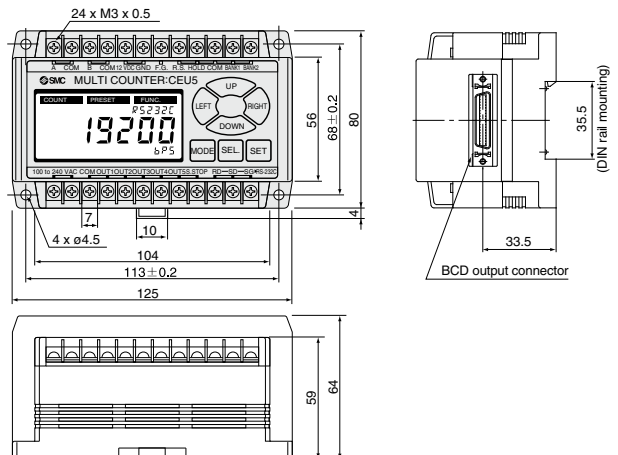

Wiring with External Equipment

<Wiring with multi-counter CEU5>

1. Wiring of power source for driving counter

For power source for driving counter, use the one with 90 to 264 VAC, 50/60 Hz or 21.6 to 26.4 VDC, 0.4 A or more.

2. Wiring for control signal input

(Selection among Reset, Hold, Bank (Refer to page 676.)) Make each control signal to be the transistor which can run more than 15 mA or the contact output. Input time for reset signal should be more than 10 ms. Bank (Refer to page 676.) selection and hold will function only when the input signal is applied.

COM is common to each signal input. Applicable to NPN and PNP input. Use 24 VDC or 12 VDC for the power source of COM. Connect DC- when PNP is applied, and DC+ when NPN is applied.

CEU5 Control signal input

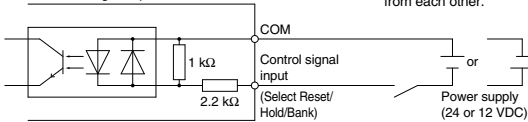

3. Output circuit

There are two outputs, the NPN open collector and the PNP open collector.

The maximum rating is 30 VDC, 50 mA. Operating the controller by exceeding this voltage and amperage could damage the electric circuit.

Therefore, the equipment to be connected must be below this rating.

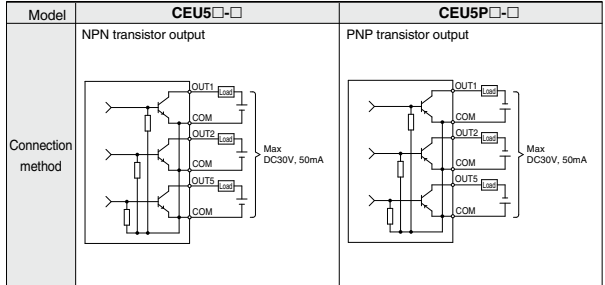

* However, the COM of the input circuit and the COM of the output circuit are electrically insulated from each other.

Extension Cable

How to Order

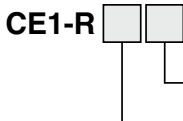

Cable length [m]		Accessory		Configuration image of product to be shipped	
				Extension cable	Connector
05	5	Nil	None		—
10	10				—
15	15				—
20	20	C	Stroke reading cylinder side connector		*1
00	Without cable	C	Stroke reading cylinder side connector	—	*1

*1 The stroke reading cylinder side connector can be mounted on the model without a connector. However, it must be soldered by the customer.

CEP1

CE1

CE2

ML2B

D-□

-X□

Operating Condition of each Output Mode

One-shot Output

Without allowable values	With allowable values
<p>When the counter value passes the preset value, output is turned ON for 100 ms.</p>	<p>When the counter value passes the sum of the preset value + the allowed value, output is turned ON for 100 ms.</p>

Hold Output

Without allowable values	With allowable values
<p>When the counter value passes the preset value, output is turned ON and that state is maintained. Output is cancelled when the power is turned off, the reset signal is input or when the setting value is changed.</p>	<p>When the counter value passes the sum of the preset value + the allowed value, output is turned ON. Output is cancelled when the power is turned off, the reset signal is input or when the setting value is changed.</p>

Compare Output

Without allowable values	With allowable values
<p>Output is turned ON only when the counter value coincides with the preset value.</p>	<p>When the counter value passes the sum of the preset value + the allowed value, output is turned ON.</p>

CEP1

CE1

CE2

ML2B

D-□

-X□

CEU5 Operation

Parts description

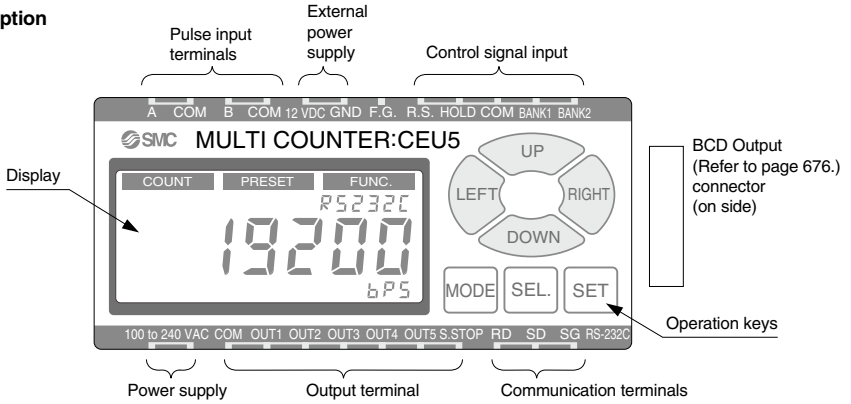

Display detail

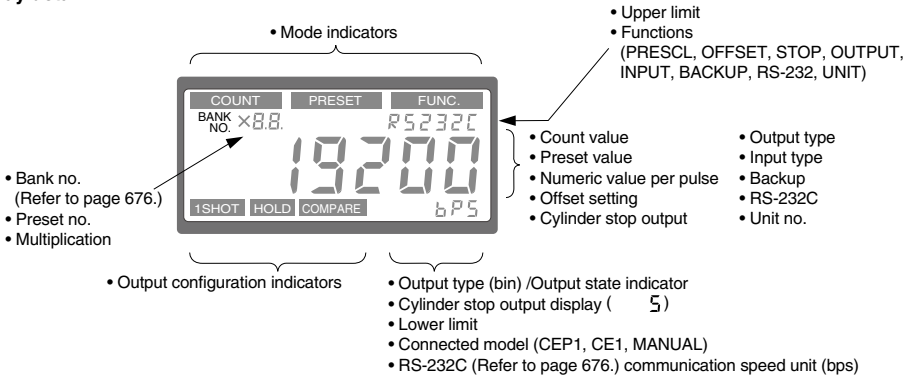

Key and Functions

Key	Functions
MODE	Changes the mode. In any given condition, it shifts to the next mode. Does not write data.
SEL.	Shifts the cursor to the next item. Does not write data.
SET	Writes displayed data into the memory when setting.
RIGHT	Shifts the cursor to the right when setting numerical values.
LEFT	Shifts the cursor to the left when setting numerical values.
UP	Changes the contents of a setting. Increases the value when setting numerical values.
DOWN	Changes the contents of a setting. Decreases the value when setting numerical values.

In the explanations of the operating method, references to "Direction keys" indicate the 4 keys RIGHT, LEFT, UP and DOWN.

Mode cycle using mode key

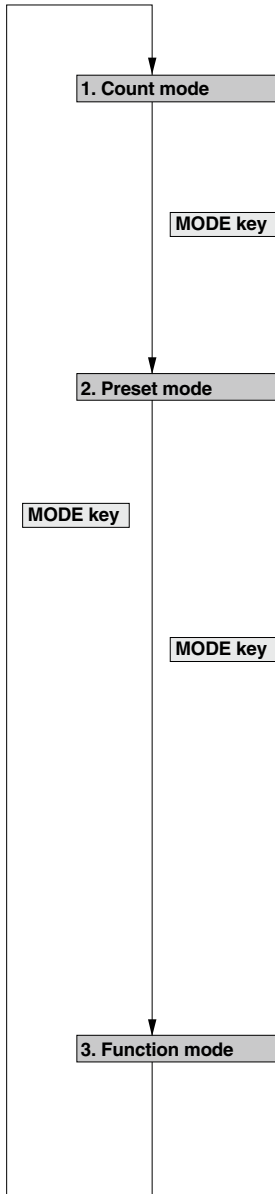

Basic Operation

- **SET key** : In any of the conditions (1) through (5), this writes the display data into the memory and shifts to (1).
- **SEL. key** : Shifts to the next item, but does not write data.
- **MODE key** : In any given condition, this shifts to the next mode, but does not write data.
- **Direction keys** : LEFT/RIGHT keys shift the digits, and UP/DOWN keys increase or decrease numerical values.

1. Explanation of display in count mode

Normal output display

Displays current output bank (Refer to page 676.)



Displays output state of each OUT terminal

Binary output display

Displays only when matched with preset

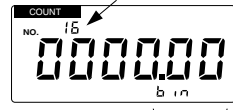

Display of binary output selection.

2. Setting of preset mode

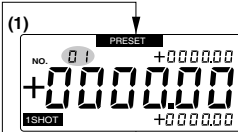

Selection of preset No.

- Select a preset number from 1 to 31 with the UP/DOWN keys.
- Shift to the next item with the SEL. key.

SEL. key



Setting the preset values

- Shift the digits with the LEFT/RIGHT keys, and increase or decrease the numerical values with the UP/DOWN keys.
- Shift to the next item with the SEL. key.

SEL. key



Setting the upper limit tolerance

- Set numerical values in the same way with the direction keys.
- When ± is selected, the lower limit display is cleared and ± setting is possible.
- Shift to the next item with the SEL. key.

SEL. key



Setting the lower limit tolerance

- Set numerical values in the same way with the direction keys.
- When ± is selected in the upper limit setting, this item is not displayed.
- Shift to the next item with the SEL. key.

SEL. key

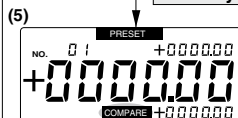

Setting the output configuration

- Switch to 1SHOT, HOLD or COMPARE with the UP/DOWN keys.
- Store the setting with the SET key.
- The SEL. key only shifts to another item without storing the setting.

SET. key

CEP1

CE1

CE2

ML2B

D-□

-X□

CEU5 Operation

3. Explanation of settings in the function mode

If the UP/DOWN keys are pressed when an item name is flashing, it shifts to another setting item. When the SEL. key is pressed, the cursor shifts and it is possible to change the content of the setting for the item which is being displayed.

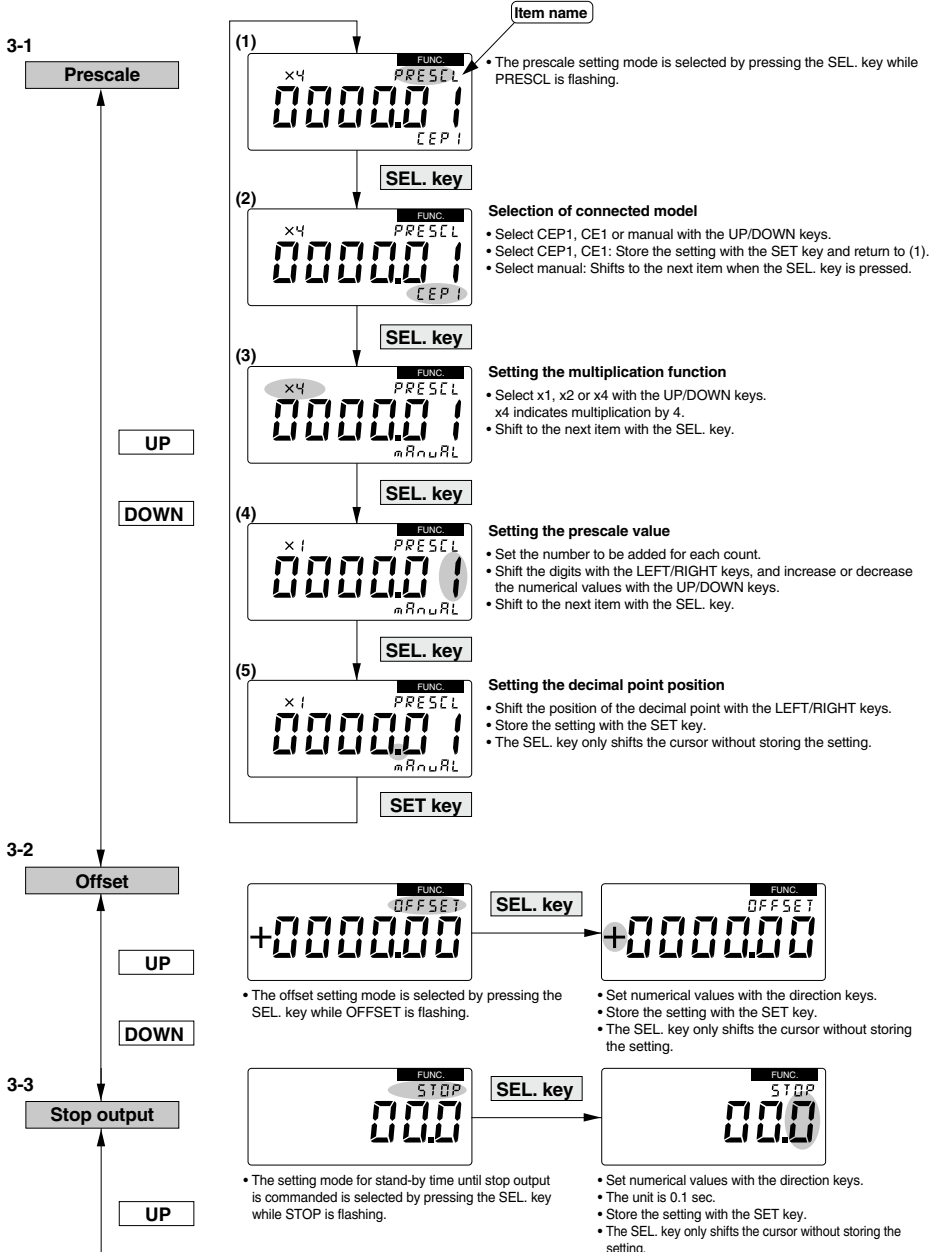

CEP1
CE1
CE2
ML2B

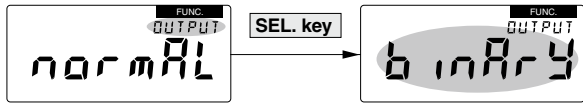
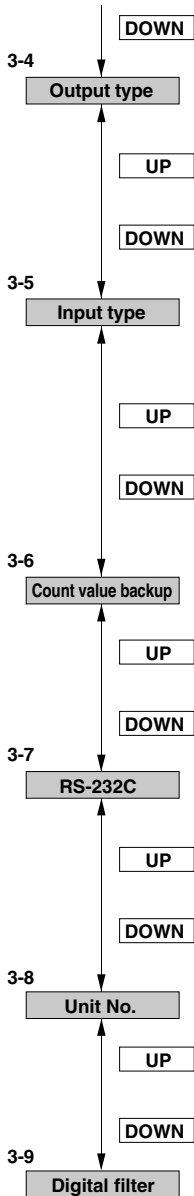

• The output system setting mode is selected by pressing the SEL. key while OUTPUT is flashing.

- Select normal output or binary output with the UP/DOWN keys.
- Store the setting with the SET key.
- The SEL. key only shifts the cursor without storing the setting.

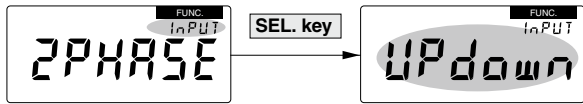

• The input type setting mode is selected by pressing the SEL. key while INPUT is flashing.

- Select phase difference input with the UP/DOWN keys, (±2PHASE) or separate input (±UP/DOWN) with the UP/ DOWN keys.
- If the polarity changes, the count direction reverses.

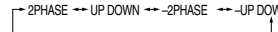

- Store the setting with the SET key.
- The SEL. key only shifts the cursor without storing the setting.

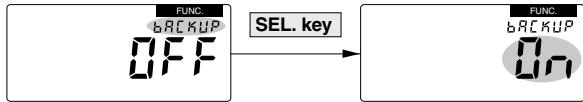

• The count value backup setting mode is selected by pressing the SEL. key while BACKUP is flashing.

- Select ON or OFF with the UP/DOWN keys.
- Store the setting with the SET key.
- The SEL. key only shifts the cursor without storing the setting.

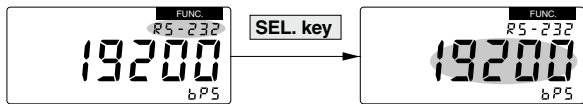

• The RS-232C (Refer to page 676.) communication speed setting mode is selected by pressing the SEL. key while RS-232 is flashing.

- Select the communication speed from 1200, 2400, 4800, 9600 or 19200 with the UP/DOWN keys.
- Store the setting with the SET key.
- The SEL. key only shifts the cursor without storing the setting.

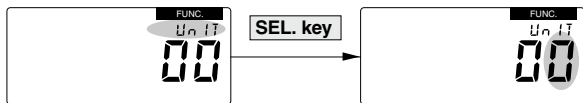

• The unit number registration mode is selected by pressing the SEL. key while UNIT is flashing.

- Set numerical values with the direction keys.
- Settings can be made from 00 to 99.
- Store the setting with the SET key.

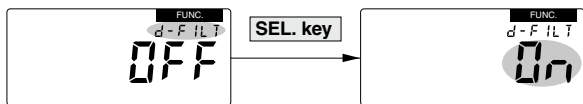

- Select ON or OFF with the UP/DOWN key.
- Store the setting with the SET key.

Note) When the digital filter setting (ON/OFF) is changed, an error count will occur. Reset the count value.

D-
-X

Glossary (Functions of CEU5)

BCD Output

This is a system which expresses one digit of a decimal number with a 4 digit binary number.
The count value is expressed by the ON/OFF state of each BCD output terminal. In the case of 6 digits, 24 terminals are required.

The relation between decimal numbers and BCD codes is shown in the table below.

Decimal no.	0	1	2	3	4	5	6	7	8	9
BCD	0000	0001	0010	0011	0100	0101	0110	0111	1000	1001

Ex.) 1294.53 is expressed as follows.
0001 0010 1001 0100 0101 0011

RS-232C

This is the interface standard for the serial transmission method, which is standard equipment on a personal computer.

Prescale Function

This function allows free setting of how many millimeters will indicate one pulse.

Binary Output

31 point preset output is possible without bank switching, by means of binary system output from a 5 point output terminal. Cylinder stop output is used as the readout release signal.

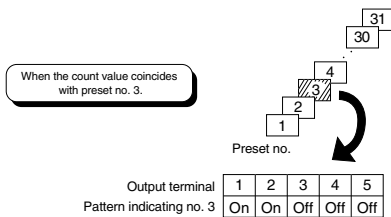

The coincident preset number is expressed as a 5 digit binary number.

Bank Function

5 points of preset output are possible simultaneously, however, a maximum of 20 types of work discrimination, etc. can be performed by using the 5 points of preset values as one of a maximum of four quadrats, and switching its use during operation.

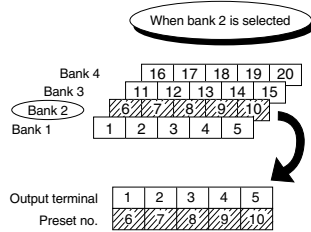

For example, when bank 2 is selected, presets 6 through 10 are valid and when the count value coincides with the setting value of 6 through 10, the respective output terminals 1 through 5 are turned ON.

Bank Switching Correspondence

Input terminal / Bank no.	BANK2	BANK1
1	OFF	OFF
2	OFF	ON
3	ON	OFF
4	ON	ON

Display Offset Function

Normally the count value returns to "0" after resetting, but with this function, the initial value can be set to any desired value.

Hold Function

When "hold" is input, the counter holds the current count value in memory. Next, when the count value is read into a PLC which uses serial or BCD output, etc., the count value that was held can be read in, even if there is a time lag.

Setting the Tolerances of Preset Values

The tolerance can be set as + \circ mm and - \blacktriangle mm. Additionally, the setting of + \circ mm and + \triangle mm, or - \bullet mm and - \blacktriangle mm is also possible. (However, $\circ > \triangle$ and $\blacktriangle > \bullet$ should be satisfied.)

By including preset tolerance setting, superior performance is exhibited in parts inspections, etc. In a workpiece to be measured, there are tolerances which assure a good product. For example, in the case of $10^{+0.05}_{-0.02}$, the CEU5 allows these tolerances to be input as they stand. If the workpiece is within tolerances the OK signal is sent.

<Simple input as per drawing dimensions> Tolerances can be set with the preset value. OK/NG signal is output by the counter. Labor savings can be realized in parts inspections.

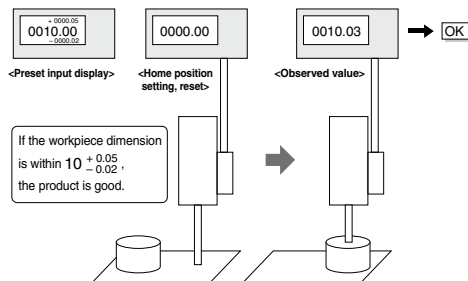

Count Value Protection

In the past, the count value returned to "0" when the power supply was cut off, but this function holds the previous value even after a power failure. This function can be switched between active and inactive settings.

Cylinder Stop Output

When workpiece discrimination is performed using a preset counter, it has been common to estimate the amount of time from the cylinder's start of operation until it touches the workpiece and stops, using a timer to read the output after a fixed amount of time. Since cylinder stop output is now output when there is no cylinder movement for a fixed amount of time, timing of preset output and external output, etc. is simplified.

CEP1

CE1

CE2

ML2B

D-□

-X□