

Membrane Air Dryer

IDG□A/IDG Series

RoHS

Possible to easily supply dry air using the hollow fiber membrane!

Non-fluorocarbon

Compatible with low dew point (-60°C)

No vibration or heat discharge

Energy saving

Reduced in purge air flow by up to **39** (L/min [ANRI])

Reduced purge
IDG□A Series



Cost reduced by up to

21,060 yen/year!

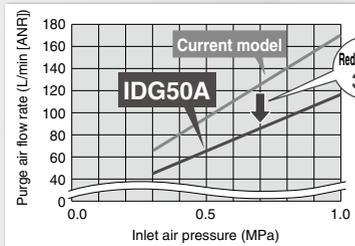

Purge air flow rate (rated conditions)

Model	Running cost (yen/year)	Purge air flow rate (L/min [ANRI])	Purge ratio (%)
IDG50A	46,440	86	15
Current model	67,500	125	20

[Calculation conditions]

Air unit price: 3 yen/m³ Operating hours: 12 hours/day Annual operating days: 250 days/year



Variations

Single Unit Type

Reduced purge
IDG□A Series



IDG□A

Purge air flow reduction type

A white body is introduced.

IDG1

Tube configuration low flow rate type



ø6 One-touch fitting

Unit Type

Adopted a new air combination with reduced required maintenance space and weight*! * Except AR



<Type M>

When dry clean air is required.

Mist separator

+

Micro mist separator

+

IDG



<Type V>

When dry clean air and pressure control are required.

Mist separator

+

Micro mist separator

+

IDG

+

Regulator

Single Unit

Body size	1	3, 5 10, 20	30	50	60	75	100
Standard dew point	●	●	★	★	●	●	●
-20°C/Nil	●	●	★	★	●	●	●
-15°C/Type H	●	●	★	★	●	●	●
-40°C/Type L	●	●	★	★	●	●	●
-60°C/Type S	●	●	★	★	●	●	●

★ IDG□A

● IDG

Space saving

Total length is shortened.
IDG30A to 100A Series
Max. 59 mm (mm)

Size	30	50	60	75	100
Shortened dimension	2	7	44	54	59
IDG□A	291	330	348	418	483
Current model	271	315	392	472	542

* Standard dew point: -40°C/L, -60°C/S



Flexible mounting orientation
IDG1 Series
 Easy to install in narrow spaces!

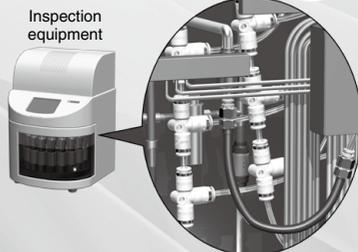

- Min. bending radius: **35 mm**
- Possible to dehumidify like a tube.
- Weight: **45 g**

High performance

Time to reach the standard dew point
 Shortened by **40 minutes**

Under SMC test condition

Model	Time to reach the standard dew point (minutes)	
	60	90
IDG100SA	60	40 minutes
Current model		100

With dew point indicator for visual confirmation of the air state

(Except IDG1)
 (Semi-standard: IDG3, IDG5, IDG3H, IDG5H)

- Color of the dew point indicator
- Blue (Green): Dry state
- Pink (Yellow): Wet state



Model with fitting for purge air discharge is also available.

When purge air discharge is undesirable in the area around the membrane air dryer, it can be discharged to atmosphere via tubing (semi-standard).

Fitting for exhausting purge air for dew point indicator

Fitting for exhausting purge air for dehumidification



Reduced in purge air discharge noise with built-in silencer

(Except IDG1, IDG3, IDG3H, IDG5, IDG5H, IDG30A, IDG30HA, IDG30LA, IDG50A, IDG50HA, IDG50LA)

Dehumidification Principle

The membrane air dryer uses hollow fibers composed of a macro molecular membrane through which moisture passes easily, but is difficult for air (oxygen and nitrogen) to pass through.

When humid, compressed air is supplied to the inside of the hollow fibers, only moisture permeates the membrane and moves to the outside due to the pressure difference between the moisture inside and outside of the fibers. The compressed air becomes dry air and continues out of the dryer. Part of the dry air from the outlet side is passed through a very small orifice to reduce the pressure and purge the outside of the hollow fibers. The moisture which permeated to the outside of the hollow fibers is discharged to the atmosphere by this purge air. In this way, the partial pressure outside of the hollow fibers remains low and dehumidification is continuously performed.

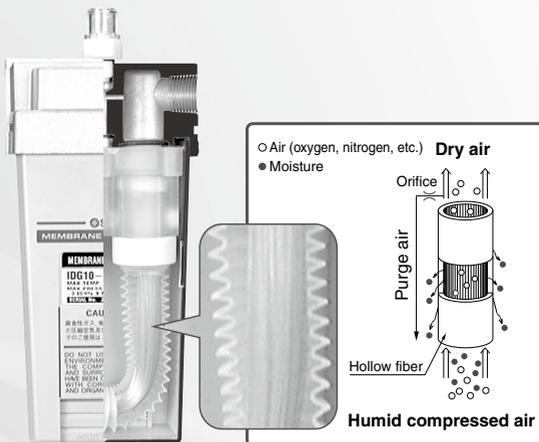

Application Examples

Machine Tool

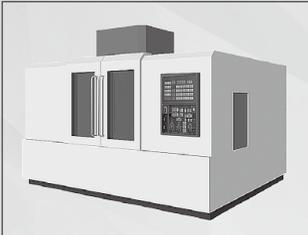

Measuring Machine

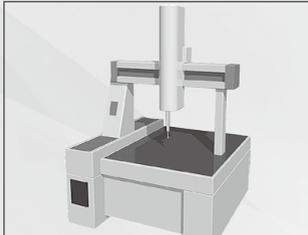

Semiconductor-related Manufacturing Equipment



Powder Coating

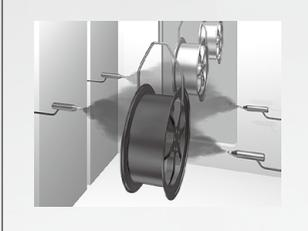

Food Machinery



Packaging Machine (sealing of film and paper package)

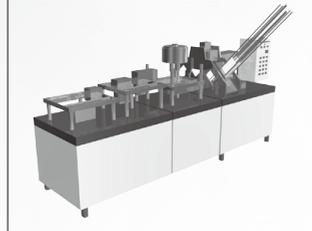

Others

- Dental equipment
- Chemical analysis equipment
- Ozonizers, Hydrogen gas generating equipment
- Printed circuit board IC mounting machines
- Fine particle drying, Transfer equipment
- Drying and cleaning of precision parts
- Condensation prevention in control panels
- General pneumatic equipment and pneumatic tools

Series Variations

Meets a wide variety of flow rates (10 to 1000 L/min [ANR]) and dew points (Atmospheric pressure dew point: -15°C to -60°C).

Single Unit Type

Standard dew point: -20°C		Standard dew point: -15°C		Standard dew point: -40°C		Standard dew point: -60°C	
Series	Outlet air flow rate (L/min [ANR])	Series	Outlet air flow rate (L/min [ANR])	Series	Outlet air flow rate (L/min [ANR])	Series	Outlet air flow rate (L/min [ANR])
IDG1	10						
IDG3	25	IDG3H	25				
IDG5	50	IDG5H	50				
IDG10	100	IDG10H	100				
IDG20	200	IDG20H	200				
IDG30A	300	IDG30HA	300	IDG30LA	75		
IDG50A	500	IDG50HA	500	IDG50LA	110		
IDG60	600	IDG60H	600	IDG60LA	170	IDG60SA	50
IDG75	750	IDG75H	750	IDG75LA	240	IDG75SA	100
IDG100	1000	IDG100H	1000	IDG100LA	300	IDG100SA	150

P.206
P.207

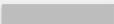
 = Reduced purge

Note) Standard dew point: Outlet air atmospheric pressure dew point under standard performance conditions
Outlet air flow rate: Values under standard performance conditions



Unit Type

<Type M>

A mist separator, micro mist separator, or micro mist separator with pre-filter combined with a single unit

Standard dew point: -20°C		Standard dew point: -15°C		Standard dew point: -40°C		Standard dew point: -60°C	
Series	Outlet air flow rate (L/min [ANR])	Series	Outlet air flow rate (L/min [ANR])	Series	Outlet air flow rate (L/min [ANR])	Series	Outlet air flow rate (L/min [ANR])
IDG3M4	25	IDG3HM4	25				
IDG5M4	50	IDG5HM4	50				
IDG10M4	100	IDG10HM4	100				
IDG20M4	200	IDG20HM4	200				
IDG30AM4	300	IDG30HAM4	300	IDG30LAM4	75		
IDG50AM4	500	IDG50HAM4	500	IDG50LAM4	110		
IDG60M2	600	IDG60HM2	600	IDG60LAM4	170	IDG60SAM4	50
IDG75M2	750	IDG75HM2	750	IDG75LAM4	240	IDG75SAM4	100
IDG100M2	1000	IDG100HM2	1000	IDG100LAM4	300	IDG100SAM4	150

* Rated conditions: Inlet air pressure 0.7 MPa, Inlet air temperature 25°C



P.220
P.221

<Type V>

A regulator combined with the type M

Standard dew point: -20°C		Standard dew point: -15°C		Standard dew point: -40°C		Standard dew point: -60°C	
Series	Outlet air flow rate (L/min [ANR])	Series	Outlet air flow rate (L/min [ANR])	Series	Outlet air flow rate (L/min [ANR])	Series	Outlet air flow rate (L/min [ANR])
IDG3V4	25	IDG3HV4	25				
IDG5V4	50	IDG5HV4	50				
IDG10V4	100	IDG10HV4	100				
IDG20V4	200	IDG20HV4	200				
IDG30AV4	300	IDG30HAV4	300	IDG30LAV4	75		
IDG50AV4	500	IDG50HAV4	500	IDG50LAV4	110		
IDG60V4	600	IDG60HV4	600	IDG60LAV4	170	IDG60SAV4	50
IDG75V4	750	IDG75HV4	750	IDG75LAV4	240	IDG75SAV4	100
IDG100V4	1000	IDG100HV4	1000	IDG100LAV4	300	IDG100SAV4	150

* Rated conditions: Inlet air pressure 0.7 MPa, Inlet air temperature 25°C

P.220
P.221

Made to Order

Symbol	Specifications	
-X016	With element service indicator	P.238
-X017	With micro mist separator regulator	P.242
-X032	With differential pressure gauge	P.246



Membrane Air Dryer Single Unit Type



IDG□A Series

Standard dew point -20°C , -15°C , -40°C , -60°C

How to Order



IDG **30** □ A - □ **03** □ - □

Size ●

30
50
60
75
100

Standard dew point temperature/Outlet air flow rate ●

Symbol	Standard dew point (°C)	Flow rate by size, Outlet air flow rate (L/min [ANRI])				
		30	50	60	75	100
Nil	-20	300	500	Select from IDG Series (page 207)		
H	-15	300	500			
L	-40	75	110	170	240	300
S	-60	—	—	50	100	150

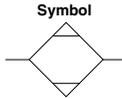

Thread type ●

Symbol	Type
Nil	Rc
N	NPT
F	G

● Semi-standard

Symbol	Specifications
Nil	None (Standard)
P	With fitting for purge air discharge
R	Flow direction (Right → Left)

Note) In the case of more than one symbol, indicate them alphabetically.

● Accessory

Symbol	Specifications
Nil	None (Standard)
B	With bracket

Note) When symbol: B is indicated, a bracket assembly with a part number shown to the left below is included as an accessory.



● Port size

Symbol	Port size	Size				
		30	50	60	75	100
02	1/4	●	●	—	—	—
03	3/8	●	●	●	●	●
04	1/2	—	—	●	●	●

Bracket Assembly (Accessory)/Part No.

Part no.	Applicable model
BM64	IDG30□A, IDG50□A
BM65	IDG60□A, IDG75□A, IDG100□A

* With hexagon socket head cap screws (2 pcs.) and spring washers (2 pcs.)

Membrane Air Dryer Single Unit Type **IDG Series**

How to Order

IDG **10** - **02** -



Size ●

1
3
5
10
20
60
75
100

Standard dew point temperature/Outlet air flow rate ●

Symbol	Standard dew point (°C)	Flow rate by size, Outlet air flow rate (L/min [ANR])							
		1	3	5	10	20	60	75	100
Nil	-20	10	25	50	100	200	600	750	1000
H	-15	—	25	50	100	200	600	750	1000
L	-40	—	—	—	—	—	—	—	—
S	-60	—	—	—	—	—	Select from IDG□A Series (page 206)		

● Accessory

Symbol	Specifications
Nil	None (Standard)
B	With bracket (Except IDG1)

Note) When symbol: B is indicated, a bracket assembly with a part number shown to the left below is included as an accessory.

● Port size/Applicable tubing O.D.

Symbol	Port size	Piping type	Size								
			1	3	5	10	20	60	75	100	
01	1/8	Thread	—	●	●	—	—	—	—	—	—
02	1/4		●	●	●	●	●	—	—	—	—
03	3/8		—	—	—	●	●	●	—	—	—
04	1/2		—	—	—	—	—	●	●	●	—
06	ø6	One-touch fitting	●	—	—	—	—	—	—	—	—

Thread type/One-touch fitting ●

Symbol	Type
Nil	Rc
N	NPT
F	G
C (Note)	ø6 One-touch fitting

Note) Size 1 only

Symbol



Bracket Assembly (Accessory)/Part No.

Part no.	Applicable model
BM59	IDG3, 5
BM61	IDG10
BM63	IDG20
BM65	IDG60, 75, 100

* With hexagon socket head cap screws (2 pcs.) and spring washers (2 pcs.)

Semi-standard ●

Symbol	Specifications	Size							
		1	3	5	10	20	60	75	100
Nil	None (Standard)	●	●	●	●	●	●	●	●
P	With fitting for purge air discharge	●	●	●	●	●	●	●	●
R	Flow direction (Right → Left)	—	●	●	●	●	●	●	●
S	With dew point indicator	—	●	●	—	—	—	—	—

Note) In the case of more than one symbol, indicate them alphabetically.

Standard Specifications/Single Unit Type (Standard dew point -20°C, -15°C)

Standard dew point----20°C

Model		IDG1	IDG3	IDG5	IDG10	IDG20	IDG30A	IDG50A	IDG60	IDG75	IDG100	
Range of operating conditions	Fluid ^{Note 1)}	Compressed air										
	Inlet air pressure (MPa)	0.3 to 0.85					0.3 to 1.0					
	Inlet air temperature (°C)	-5 to 55 (No freezing)					-5 to 50 (No freezing)					
Standard performance conditions	Ambient temperature (°C)	-5 to 55 (No freezing)					-5 to 50 (No freezing)					
	Outlet air atmospheric pressure dew point (°C)	-20										
	Inlet air flow rate (L/min [ANR]) ^{Note 2)}	12.5	31	62	125	250	360	586	725	900	1190	
	Outlet air flow rate (L/min [ANR])	10	25	50	100	200	300	500	600	750	1000	
	Purge air flow rate (L/min [ANR]) ^{Note 3)}	2.5	6	12	25	50	60	86	125	150	190	
	Inlet air pressure (MPa)	0.7										
	Inlet air temperature (°C)	25										
	Inlet air saturation temperature (°C)	25										
	Ambient temperature (°C)	25										
	Dew point indicator purge air flow rate	—					1 L/min [ANR] (Inlet air pressure at 0.7 MPa)					
Port size	1/4	—	1/8, 1/4	—			1/4, 3/8	3/8, 1/2	1/2			
Applicable tubing O.D.	—	ø6	—	—			—	—	—			
Weight (kg) (With bracket)	0.11	0.05	0.25 (0.31)	0.43 (0.51)	0.66 (0.76)	0.78 (0.91)	0.81 (0.94)	1.50 (1.65)	1.50 (1.65)	1.55 (1.70)	1.55 (1.70)	

Note 1) Prevent water droplets from entering the inlet port.

Note 2) "ANR" indicates the flow rate converted to the value at 20°C, under the atmospheric pressure and the state of relative humidity 65%.

Note 3) Includes 1 L/min [ANR] of purge air flow (Inlet air pressure at 0.7 MPa) for the dew point indicator (except IDG1, 3, 5).

Standard dew point----15°C/Type H

Model		IDG3H	IDG5H	IDG10H	IDG20H	IDG30HA	IDG50HA	IDG60H	IDG75H	IDG100H	
Range of operating conditions	Fluid ^{Note 1)}	Compressed air									
	Inlet air pressure (MPa)	0.3 to 0.85					0.3 to 1.0				
	Inlet air temperature (°C)	-5 to 55					-5 to 50				
Standard performance conditions	Ambient temperature (°C)	-5 to 55					-5 to 50				
	Outlet air atmospheric pressure dew point (°C)	-15									
	Inlet air flow rate (L/min [ANR]) ^{Note 2)}	28	56	111	222	329	550	665	830	1110	
	Outlet air flow rate (L/min [ANR])	25	50	100	200	300	500	600	750	1000	
	Purge air flow rate (L/min [ANR]) ^{Note 3)}	3	6	11	22	29	50	65	80	110	
	Inlet air pressure (MPa)	0.7									
	Inlet air temperature (°C)	25									
	Inlet air saturation temperature (°C)	25									
	Ambient temperature (°C)	25									
	Dew point indicator purge air flow rate	—			1 L/min [ANR] (Inlet air pressure at 0.7 MPa)						
Port size	1/8, 1/4			1/4, 3/8			3/8, 1/2		1/2		
Weight (kg) (With bracket)	0.25 (0.31)	0.43 (0.51)	0.66 (0.76)	0.78 (0.91)	0.81 (0.94)	1.50 (1.65)	1.50 (1.65)	1.55 (1.70)	1.55 (1.70)	1.55 (1.70)	

Note 1) Prevent water droplets from entering the inlet port.

Note 2) "ANR" indicates the flow rate converted to the value at 20°C, under the atmospheric pressure and the state of relative humidity 65%.

Note 3) Includes 1 L/min [ANR] of purge air flow (Inlet air pressure at 0.7 MPa) for the dew point indicator (except IDG3H, 5H).

Standard Specifications/Single Unit Type (Standard dew point -40°C, -60°C)

Standard dew point----40°C/Type L

Model		IDG30LA	IDG50LA	IDG60LA	IDG75LA	IDG100LA
Range of operating conditions	Fluid <small>Note 1)</small>	Compressed air				
	Inlet air pressure (MPa)	0.3 to 1.0				
	Inlet air temperature (°C)	-5 to 50 (No freezing)				
	Ambient temperature (°C)	-5 to 50 (No freezing)				
Standard performance	Outlet air atmospheric pressure dew point (°C)	-40				
	Inlet air flow rate (L/min [ANR]) <small>Note 2)</small>	93	135	224	308	400
Standard performance conditions	Outlet air flow rate (L/min [ANR])	75	110	170	240	300
	Purge air flow rate (L/min [ANR]) <small>Note 3)</small>	18	25	54	68	100
	Inlet air pressure (MPa)	0.7				
	Inlet air temperature (°C)	25				
	Inlet air saturation temperature (°C)	25				
	Ambient temperature (°C)	25				
	Dew point indicator purge air flow rate	1 L/min [ANR] (Inlet air pressure at 0.7 MPa)				
Port size	1/4, 3/8		3/8, 1/2			
Weight (kg) (With bracket)	0.78 (0.91)	0.81 (0.94)	1.56 (1.71)	1.69 (1.84)	1.82 (1.97)	

Note 1) Prevent water droplets from entering the inlet port.

Note 2) "ANR" indicates the flow rate converted to the value at 20°C, under the atmospheric pressure and the state of relative humidity 65%.

Note 3) Includes 1 L/min [ANR] of purge air flow (Inlet air pressure at 0.7 MPa) for the dew point indicator.

Standard dew point----60°C/Type S

Model		IDG60SA	IDG75SA	IDG100SA
Range of operating conditions	Fluid <small>Note 1)</small>	Compressed air		
	Inlet air pressure (MPa)	0.3 to 1.0		
	Inlet air temperature (°C)	-5 to 50 (No freezing)		
	Ambient temperature (°C)	-5 to 50 (No freezing)		
Standard performance	Outlet air atmospheric pressure dew point (°C)	-60		
	Inlet air flow rate (L/min [ANR]) <small>Note 2)</small>	75	140	230
Standard performance conditions	Outlet air flow rate (L/min [ANR])	50	100	150
	Purge air flow rate (L/min [ANR]) <small>Note 3)</small>	25	40	80
	Inlet air pressure (MPa)	0.7		
	Inlet air temperature (°C)	25		
	Inlet air saturation temperature (°C)	25		
	Ambient temperature (°C)	25		
	Dew point indicator purge air flow rate	1 L/min [ANR] (Inlet air pressure at 0.7 MPa)		
Port size	3/8, 1/2			
Weight (kg) (With bracket)	1.56 (1.71)	1.69 (1.84)	1.82 (1.97)	

Note 1) Prevent water droplets from entering the inlet port.

Note 2) "ANR" indicates the flow rate converted to the value at 20°C, under the atmospheric pressure and the state of relative humidity 65%.

Note 3) Includes 1 L/min [ANR] of purge air flow (Inlet air pressure at 0.7 MPa) for the dew point indicator.

Conditions: Inlet air temperature 25°C (saturated air), Ambient temperature 25°C, P₁: Inlet air pressure, Tube for purge air discharge (semi-standard: P); None
 Note: Correcting outlet air flow rate is required depending on inlet air temperature. Refer to page 236 for details. For model with fitting for purge air discharge (semi-standard: P), the outlet air atmospheric pressure dew point may become higher depending on the tube length for purge air discharge. For other models, when the tube length is 5 meters or less, a rise of the outlet air atmospheric pressure dew point will be 1°C or less.

Performance Chart

Standard dew point---20°C [Symbol: Nil], -15°C [Symbol: H]

IDG1

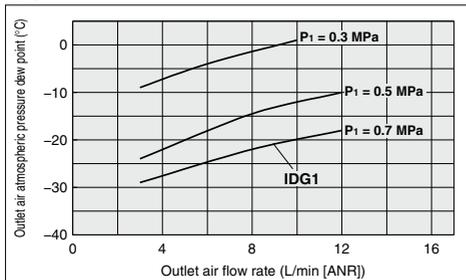

IDG3, IDG3H

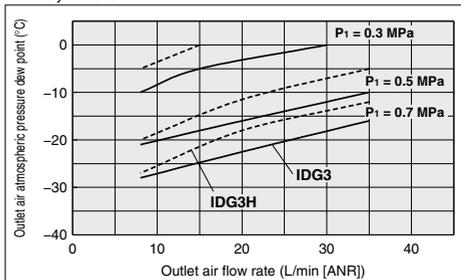

IDG5, IDG5H

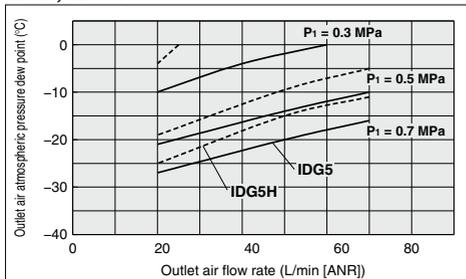

IDG10, IDG10H

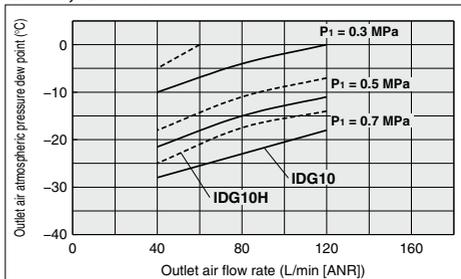

IDG20, IDG20H

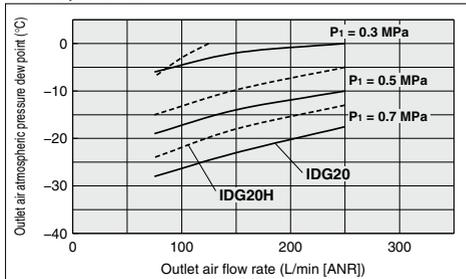

IDG30A, IDG30HA

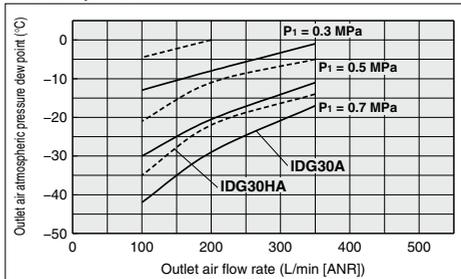

IDG50A, IDG50HA

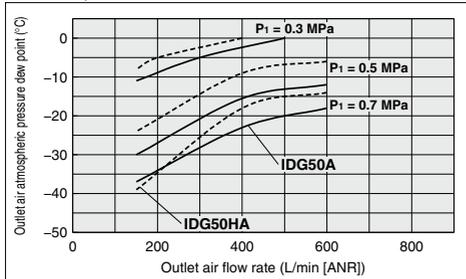

IDG60, IDG60H

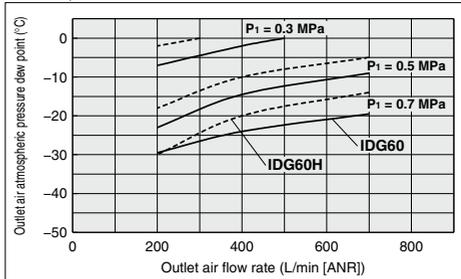

Performance Chart

IDG75, IDG75H

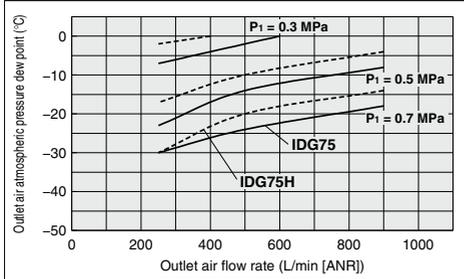

IDG100, IDG100H

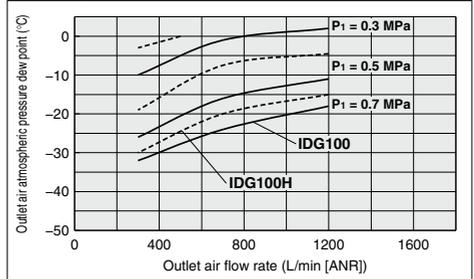

Standard dew point: ---40°C [Symbol: L], -60°C [Symbol: S]

IDG30LA, IDG50LA

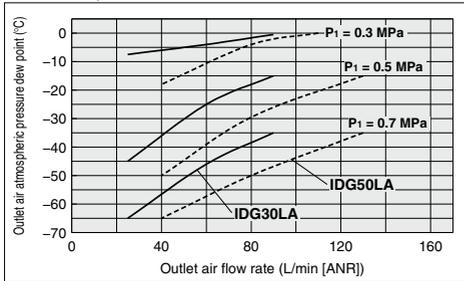

IDG60LA, IDG60SA

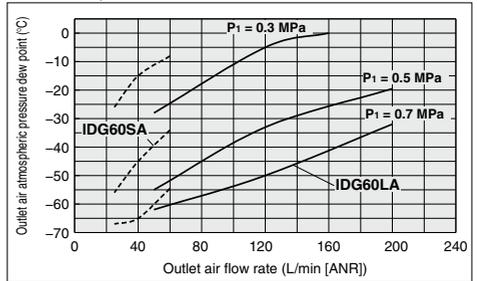

IDG75LA, IDG75SA

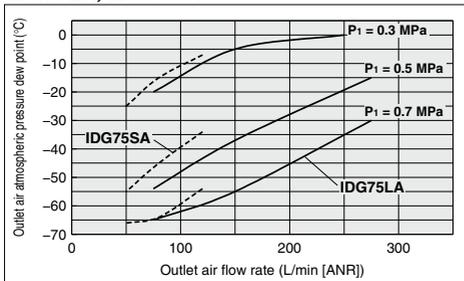

IDG100LA, IDG100SA

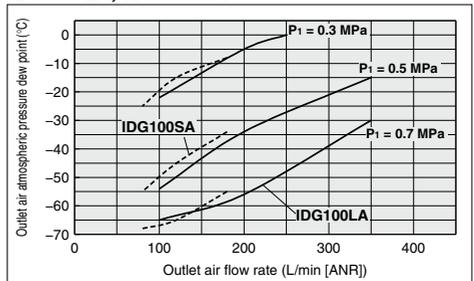

How to read the Performance Chart and select the model

Solid lines and dashed lines beginning at the top indicate the performance of inlet air temperature at 25°C and inlet air pressure $P_1 = 0.3$ MPa, 0.5 MPa, 0.7 MPa respectively.

- For the inlet air temperature at 25°C and outlet air flow rate at 45 (L/min)
Model ①: The outlet air atmospheric pressure dew point at $P_1 = 0.7$ MPa: -25 (°C).

- For the inlet air temperature at 45°C and outlet air flow rate at 45 (L/min)
Example) Outlet air flow rate correction factor: 0.75
(The correction factor differs depending on the model. Refer to page 236 for details.)
Corrected outlet air flow rate: $45 \div 0.75 = 60$ (L/min).

Model ①: Performing corresponding to the outlet air atmospheric pressure dew point -20 (°C) at $P_1 = 0.7$ MPa.

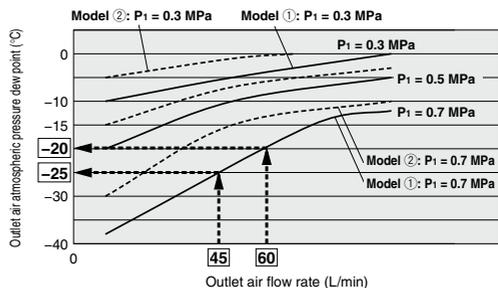

Single Unit Type/Flow Rate Characteristics

Conditions: Inlet air temperature 25°C, P₁: Inlet air pressure

Standard dew point---20°C [Symbol: Nil], -15°C [Symbol: H]

IDG1

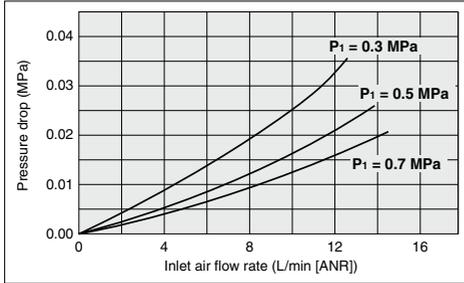

IDG3, IDG3H

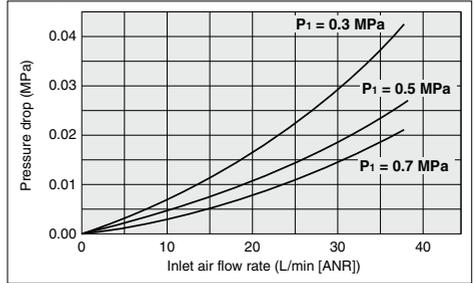

IDG5, IDG5H

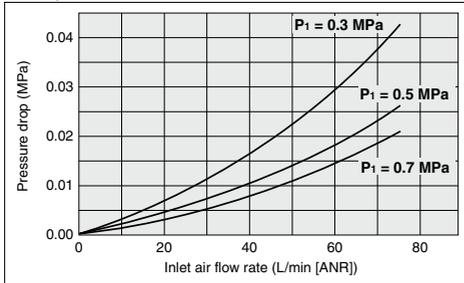

IDG10, IDG10H

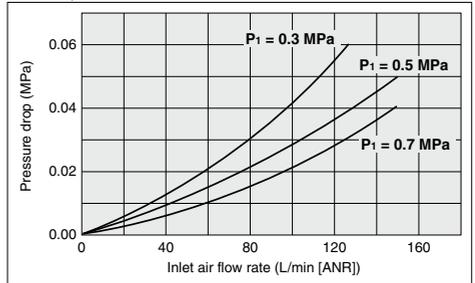

IDG20, IDG20H

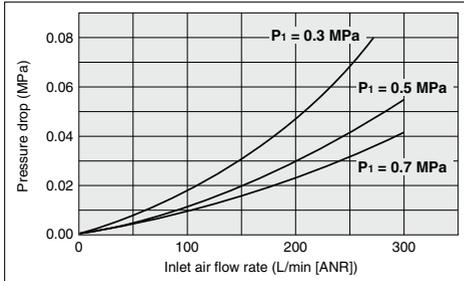

IDG30A, IDG30HA

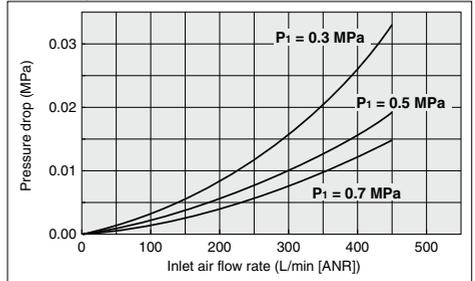

IDG50A, IDG50HA

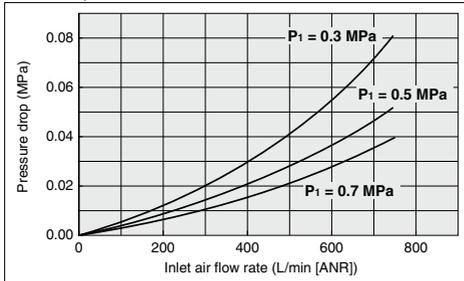

IDG60, IDG60H

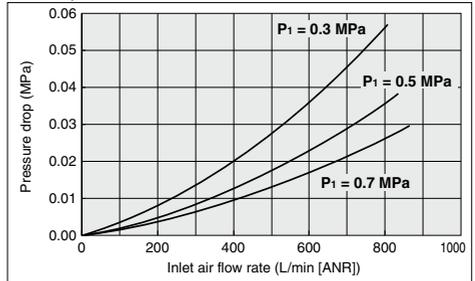

Single Unit Type/Flow Rate Characteristics

Conditions: Inlet air temperature 25°C, P₁: Inlet air pressure

Standard dew point: -20°C [Symbol: Nii], -15°C [Symbol: H]

IDG75, IDG75H

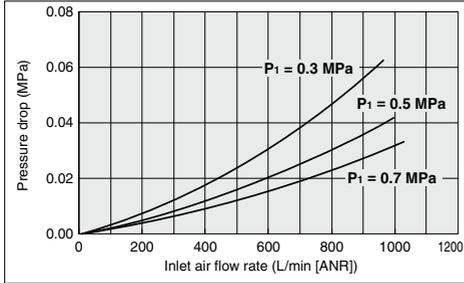

IDG100, IDG100H

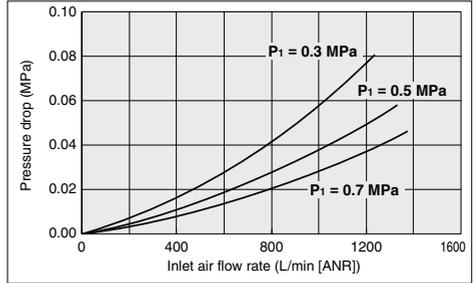

Standard dew point: -40°C [Symbol: L], -60°C [Symbol: S]

IDG30LA

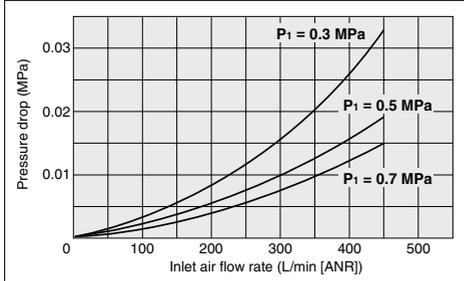

IDG50LA

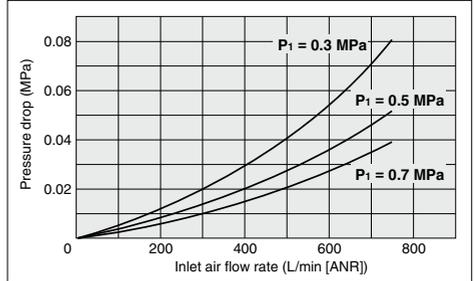

IDG60LA, IDG60SA

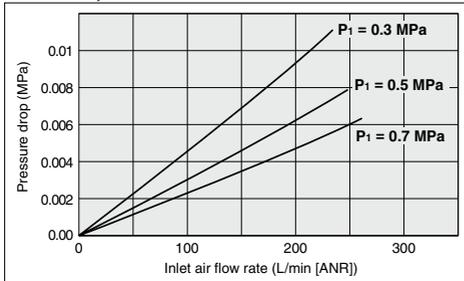

IDG75LA, IDG75SA

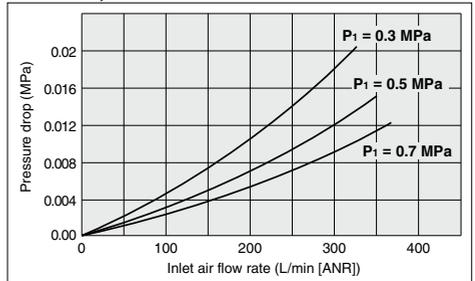

IDG100LA, IDG100SA

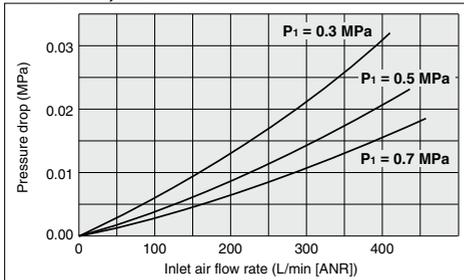

With fitting for purge air discharge (Semi-standard: P)

As the tube length for purge air discharge becomes longer, the outlet air atmospheric pressure dew point becomes higher. Refer to the table below.

Tube length	IDG30A	IDG30LA
0 m	-20	-40
1 m	-19	-39
3 m	-17	-38
5 m	-16	

■Conditions

Inlet air temperature : 25°C (Saturated)

Ambient temperature : 25°C

Inlet air pressure : 0.7 MPa

Outlet air flow rate : Flow gained under conditions of the standard performance. (Refer to pages 208 and 209.)

Tube size : O.D. ϕ 12 x I.D. ϕ 9

Purge Air Flow Rate Characteristics

IDG1, 3, 5, 10, 20 (Standard dew point -20°C)
IDG3H, 5H, 10H, 20H (Standard dew point -15°C)

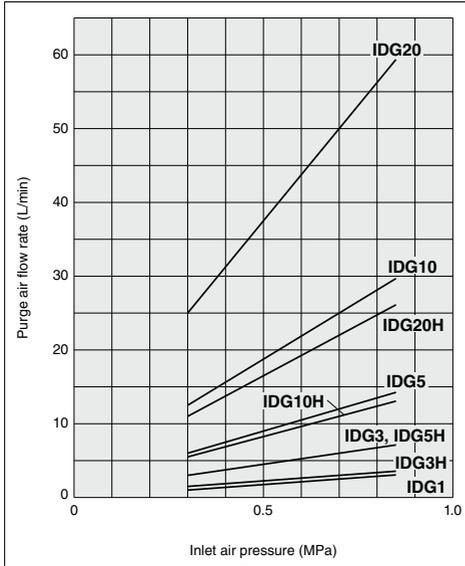

IDG30A, 50A (Standard dew point -20°C)
IDG30HA, 50HA (Standard dew point -15°C)
IDG30LA, 50LA (Standard dew point -40°C)

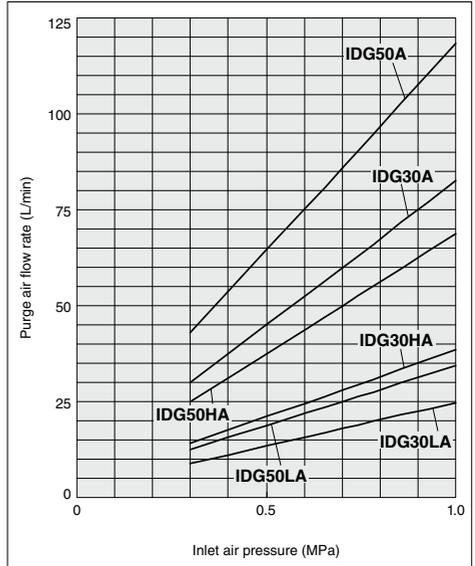

IDG60, 75, 100 (Standard dew point -20°C)
IDG60H, 75H, 100H (Standard dew point -15°C)

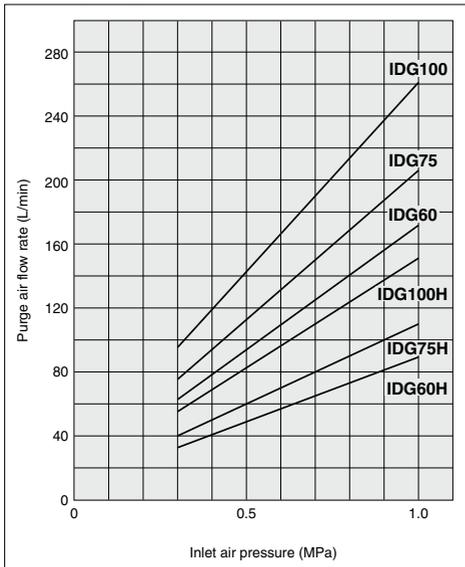

IDG60LA, 75LA, 100LA (Standard dew point -40°C)
IDG60SA, 75SA, 100SA (Standard dew point -60°C)

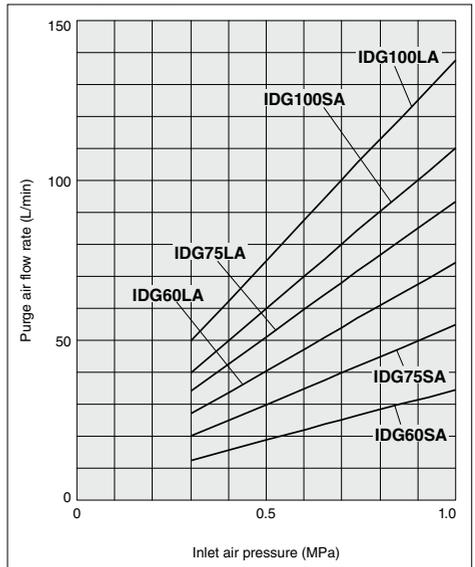

Construction

IDG1

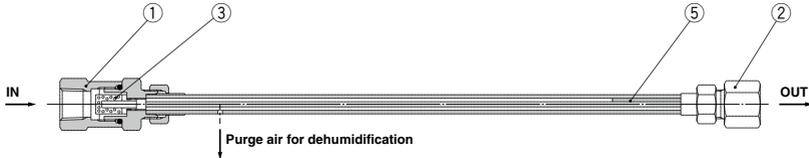

Semi-standard With fitting for purge air discharge (Semi-standard: P)

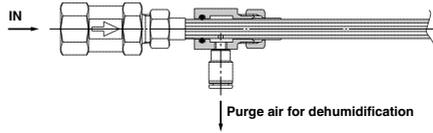

IDG3, 5 IDG3H, 5H

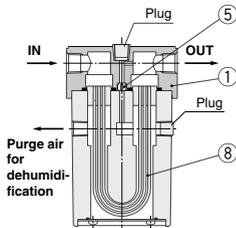

Semi-standard With fitting for purge air discharge (Semi-standard: P)

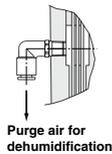

IDG10, 20 IDG10H, 20H

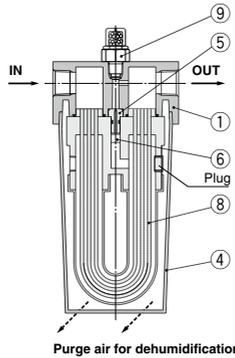

Semi-standard With fitting for purge air discharge (Semi-standard: P)

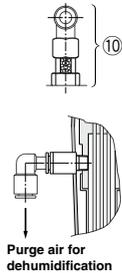

Component Parts

No.	Description	Material					Note
		IDG1	IDG3, 3H	IDG5, 5H	IDG10, 10H	IDG20, 20H	
1	Body	Brass	Aluminum alloy			Platinum silver coated (IDG1 is electroless nickel plated.)	
2	Female connector	Brass	—			Electroless nickel plated	
3	Strainer	Brass	—				
4	Case	—	—		Resin		
5	Orifice	Resin	Stainless steel				
6	Silencer	—	—		Bronze		

Replacement Parts

No.	Description	Part no.									
		IDG1	IDG3	IDG3H	IDG5	IDG5H	IDG10	IDG10H	IDG20	IDG20H	
8	Membrane module kit	—	IDG-EL3	IDG-EL3H	IDG-EL5	IDG-EL5H	IDG-EL10	IDG-EL10H	IDG-EL20	IDG-EL20H	
			With Orifice (1 pc.), O-ring (3 pcs.), Gasket (1 pc.)				With Orifice (1 pc.), Silencer (1 pc.), O-ring (4 pcs.)				
9	Dew point indicator kit	—	IDG-DP01 (Semi-standard: S)					IDG-DP01			
								With O-ring (1 pc.)			
10		—	IDG-DP01-X001 (Semi-standard: PS)					IDG-DP01-X001 (Semi-standard: P)			
								With O-ring (1 pc.)			

Construction

IDG30 \square **A**
IDG50 \square **A**

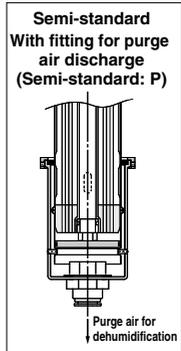
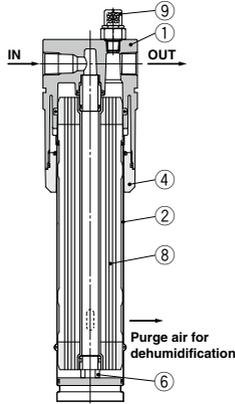

IDG60 \square , **75** \square , **100** \square
IDG60 \square **A**, **75** \square **A**, **100** \square **A**

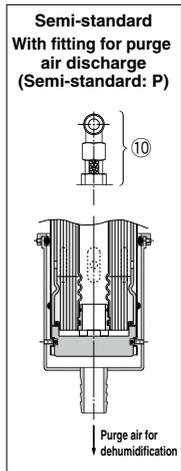
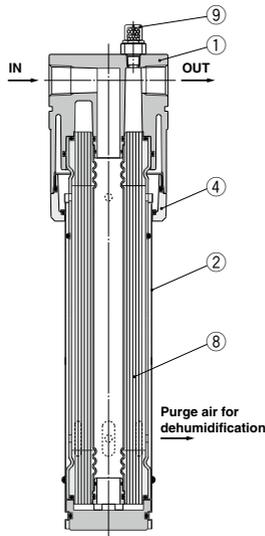

Component Parts

No.	Description	Material							Note	
		IDG30 \square A	IDG50 \square A	IDG60, 60H*	IDG60LA, 60SA	IDG75, 75H*	IDG75LA, 75SA	IDG100, 100H*		IDG100LA, 100SA
1	Body	Aluminum alloy/White							*Platinum silver coated	
2	Case	Stainless steel								
3	Orifice	Stainless steel								
4	Holder	Aluminum alloy	Aluminum alloy							
5	Silencer	—	Resin + Bronze	Resin	Resin + Bronze	Resin	Resin + Bronze	Resin		
6	Adapter	Resin	—							

Replacement Parts

No.	Description	Part no.							
		IDG30 \square A	IDG50 \square A	IDG60, 60H	IDG60LA, 60SA	IDG75, 75H	IDG75LA, 75SA	IDG100, 100H	IDG100LA, 100SA
8	Membrane module kit	IDG-EL30A	IDG-EL50A	IDG-EL60	IDG-EL60LA	IDG-EL75	IDG-EL75LA	IDG-EL100	IDG-EL100LA
9	Dew point indicator kit	IDG-DP01							
10		IDG-DP01-X001 (Semi-standard: P)							

Dimensions/Single Unit Type

IDG1

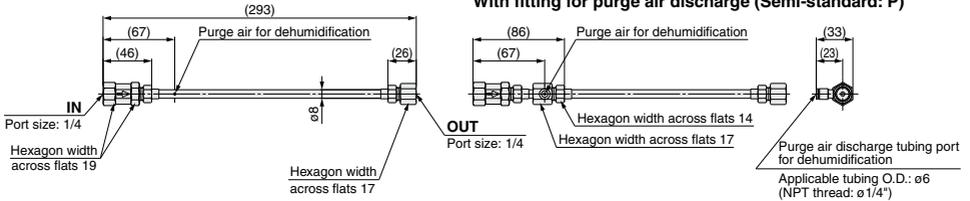

IDG1-C06: With One-touch fitting

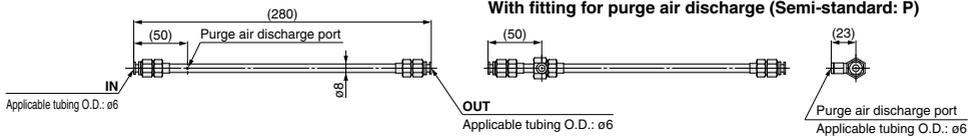

IDG3, 5 IDG3H, 5H

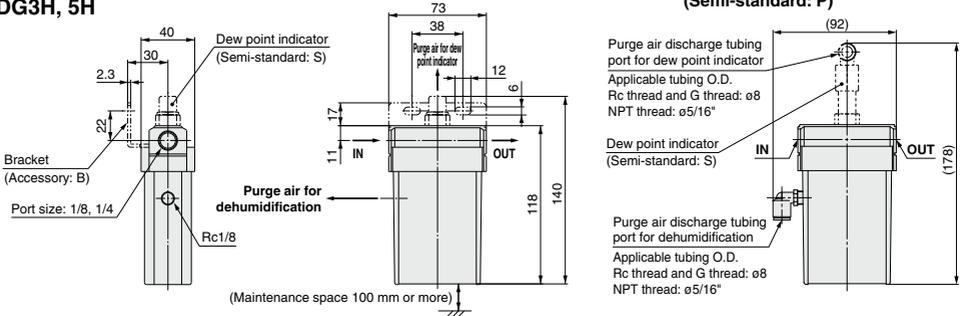

IDG10, 20 IDG10H, 20H

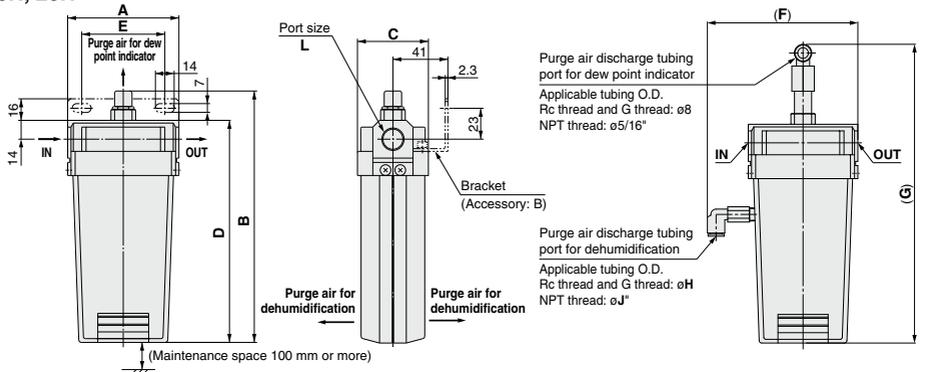

Model	Port size L	A	B	C	D	E	Semi-standard: P			
							F	G	H	J
IDG10, 10H	1/4, 3/8	83	187	53	165	62	109	225	8	5/16
IDG20, 20H		113	212	54	190	82	140 [139]	250	10	3/8

Values inside [] are for NPT thread.

Dimensions/Single Unit Type

IDG30 \square **A**
IDG50 \square **A**

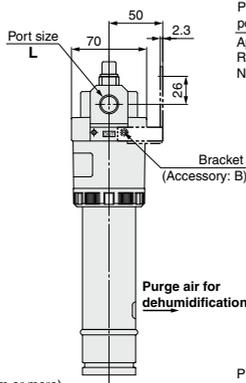
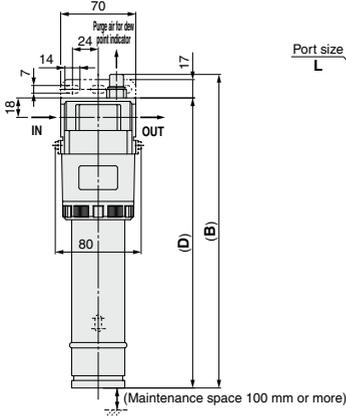

With fitting for purge air discharge (Semi-standard: P)

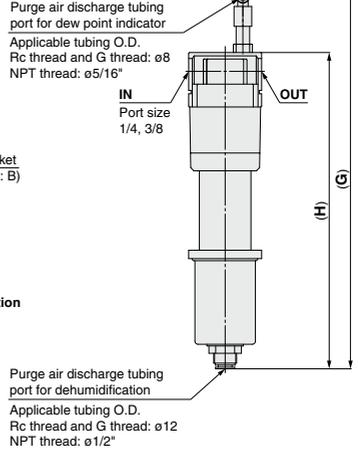

IDG60 \square , **75** \square , **100** \square
IDG60 \square **A**, **75** \square **A**, **100** \square **A**

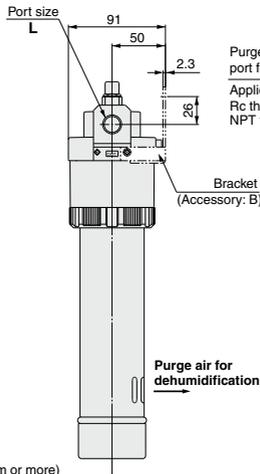
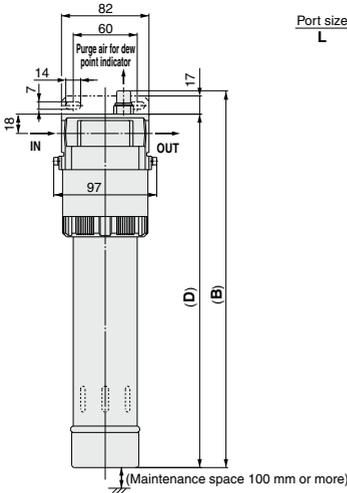

With fitting for purge air discharge (Semi-standard: P)

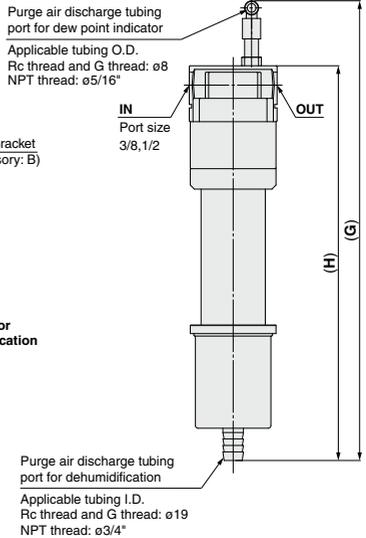

Model	Port size	L	B	D	Semi-standard: P	
					G	H
IDG30 \square A	1/4, 3/8		291	269	362	302
IDG50 \square A			330	308	401	341
IDG60 \square	3/8, 1/2		352	330	429	369
IDG75 \square , 100 \square	1/2		348	326	427	367
IDG60 \square A	3/8, 1/2		418	396	496	436
IDG75 \square A			483	461	561	501
IDG100 \square A						

Membrane Air Dryer Unit Type



IDG□A Series

Type M, Type V

How to Order



IDG **30** **H** **A** **M** 4 - **03** - - -

- Size
- 30
 - 50
 - 60
 - 75
 - 100

• **Made to Order**
Refer to pages 238 to 249 for details.

Standard dew point temperature/Outlet air flow rate

Symbol	Standard dew point (°C)	Flow rate by size, Outlet air flow rate (L/min [ANR])				
		30	50	60	75	100
Nil	-20	300	500	Select from IDG Series		
H	-15	300	500			
L	-40	75	110	170	240	300
S	-60	—	—	50	100	150

• Semi-standard*

Symbol	Specifications	Note
Nil	None (Standard)	—
P	With fitting for purge air discharge	<ul style="list-style-type: none"> • Combination with drain discharge method symbol: Nil is not available. • Combination with Type V is not available.^{Note)}
R	Flow direction (Right → Left)	—

* In the case of more than one symbol, indicate them alphabetically.
Note) Type V is not applicable because it is equipped with a relief type regulator.

• Components

Symbol	Mist separator	Micro mist separator	Membrane air dryer	Regulator
M	●	●	●	—
V	●	●	●	●

• Drain discharge method*

Symbol	Drain discharge method	Note
Nil	Manual valve	Combination with semi-standard symbol: P is not available.
C	N.C. auto-drain	Auto-drains listed on page 233 are attached.
D	N.O. auto-drain	
J	Drain guide	—

* For model selection of an auto-drain, refer to the Selection Precautions on page 250.

• Equipment connection

Symbol	Components	Contents
4	M	Modular connection
	V	

• Port size

Symbol	Port size	Size				
		30	50	60	75	100
02	1/4	●	●	—	—	—
03	3/8	●	●	●	●	●
04	1/2	—	—	●	●	●

• Thread type

Symbol	Type
Nil	Rc
N	NPT
F	G

Membrane Air Dryer

Unit Type

IDG Series



How to Order

IDG **10** **H** **M** **4** - **02** - - -

Size

3
5
10
20
60
75
100

Made to Order

Refer to pages 238 to 249 for details.

Standard dew point temperature/Outlet air flow rate

Symbol	Standard dew point (°C)	Flow rate by size, Outlet air flow rate (L/min [ANR])						
		3	5	10	20	60	75	100
Nil	-20	25	50	100	200	600	750	1000
H	-15	25	50	100	200	600	750	1000

Components

Symbol	Size	Mist separator	Micro mist separator	Micro mist separator with pre-filter	Membrane air dryer	Regulator
M	3	●	●	—	●	—
	5	●	●	—	●	—
	10	●	●	—	●	—
	20	●	●	—	●	—
	60	—	—	●	●	—
	75	—	—	●	●	—
100	—	—	●	●	—	
V	3	●	●	—	●	●
	5	●	●	—	●	●
	10	●	●	—	●	●
	20	●	●	—	●	●
	60	—	—	●	●	●
	75	—	—	●	●	●
100	—	—	●	●	●	

Equipment connection

Symbol	Components	Contents	Size						
			3	5	10	20	60	75	100
4	V	Modular connection	●	●	●	●	●	●	●
			●	●	●	●	●	●	●
2	M	Nipple connection	—	—	—	—	●	●	●

* Some parts of the connected contents are exceptions. Check the equipment composition (described later) or the external dimension drawing for details of the connection method and the contents of the equipment.

Thread type

Symbol	Type
Nil	Rc
N	NPT
F	G

Semi-standard*

Symbol	Specifications	Size							Note
		3	5	10	20	60	75	100	
Nil	Standard	●	●	●	●	●	●	●	—
P	With fitting for purge air discharge ^{Note 2)}	●	●	●	●	●	●	●	● Combination with drain discharge method symbol: Nil is not available. ● Combination with Type V is not available. ^{Note 1)}
R	Flow direction (Right → Left)	●	●	●	●	●	●	●	—
S	With dew point indicator ^{Note 3)}	●	●	Standard equipment	—	—	—	—	—

* In the case of more than one symbol, indicate them alphabetically.

Note 1) Type V is not applicable because it is equipped with a relief type regulator. (Symbol: P is used when it is undesirable for the air to be discharged into the main body of the IDG. Therefore, it is not possible to use it in combination with a separator with manual valve, which discharges air around it, or Type V with a relief type regulator.)

Note 2) They are not applicable in case the thread symbol is N or F when the size is 3, 5, 10, 20. (Because barrel nipples are used for equipment connections.)

Note 3) Select the option when the size is 3 or 5. The option is the standard equipment for other sizes.

Drain discharge method*

(Mist separator, Micro mist separator, Micro mist separator with pre-filter)

Symbol	Drain discharge method	Size							Note
		3	5	10	20	60	75	100	
Nil	Manual valve	●	●	●	●	●	●	●	● Combination with semi-standard symbol: P is not available.
C	N.C. auto-drain	●	●	●	●	—	—	—	● Auto-drains listed on page 233 are attached.
D	N.O. auto-drain	—	—	●	●	●	●	●	
J	Drain guide	●	●	●	●	●	●	●	—

* For model selection of an auto-drain, refer to the Selection Precautions on page 250.

Port size

Symbol	Port size	Size						
		3	5	10	20	60	75	100
01	1/8	●	●	—	—	—	—	—
02	1/4	●	●	●	●	—	—	—
03	3/8	—	—	●	●	●	—	—
04	1/2	—	—	—	—	●	●	●

Standard Specifications/Unit [Type M, Type V] (Standard dew point: -20°C, -15°C)

Model		Standard dew point: -20°C								
		IDG3M4	IDG5M4	IDG10M4	IDG20M4	IDG30AM4	IDG50AM4	IDG60M2	IDG75M2	IDG100M2
		IDG3V4	IDG5V4	IDG10V4	IDG20V4	IDG30AV4	IDG50AV4	IDG60V4	IDG75V4	IDG100V4
Components	Mist separator	AFM20-A (with bowl guard)			AFM30-A		AFM40-A		—	
	Micro mist separator	AFD20-A (with bowl guard)			AFD30-A		AFD40-A		—	
	Micro mist separator with pre-filter	—						AMH350C	AMH450C	
	Regulator (Type V only) ^{Note 1)}	AR20-B ^{Note 2)}		AR25-B ^{Note 2)}			AR40-B ^{Note 2)}			
Spacer	Y200T-A Y200-A (Type V only)		Y300T-A Y300-A (Type V only)		Y400T-A Y400-A (Type V only)		Y400-A (Type V only)			
Range of operating conditions	Fluid ^{Note 3)}	Compressed air								
	Inlet air pressure (MPa)	0.3 to 0.85				0.3 to 1.0				
	Inlet air temperature (°C)	-5 to 55 (No freezing)				-5 to 50 (No freezing)		5 to 50		
Standard performance conditions	Ambient temperature (°C)	-5 to 55 (No freezing)				-5 to 50 (No freezing)		5 to 50		
	Outlet air atmospheric pressure dew point (°C)	-20								
Standard performance conditions	Inlet air flow rate (L/min [ANR]) ^{Note 5)}	31	62	125	250	360	586	720	888	1185
	Outlet air flow rate (L/min [ANR])	25	50	100	200	300	500	600	750	1000
	Purge air flow rate (L/min [ANR]) ^{Note 6)}	6	12	25	50	60	86	120	138	185
	Inlet air pressure (MPa)	0.7								
	Inlet air temperature (°C)	25								
	Inlet air saturation temperature (°C)	25								
	Ambient temperature (°C)	25								
Dew point indicator purge air flow rate		1 L/min [ANR] (Inlet air pressure at 0.7 MPa)								
Regulator construction (Type V only)		Relief type								
Port size		1/8, 1/4		1/4, 3/8			3/8, 1/2		1/2	
Weight (kg)	Type M	0.6		1.0	1.3	1.8	1.9	2.7	3.2	3.3
	Type V	0.9		1.3	1.5	2.4	2.5	3.1	3.7	3.8

Model		Standard dew point: -15°C								
		IDG3HM4	IDG5HM4	IDG10HM4	IDG20HM4	IDG30HAM4	IDG50HAM4	IDG60HM2	IDG75HM2	IDG100HM2
		IDG3HV4	IDG5HV4	IDG10HV4	IDG20HV4	IDG30HAV4	IDG50HAV4	IDG60HV4	IDG75HV4	IDG100HV4
Components	Mist separator	AFM20-A (with bowl guard)			AFM30-A		AFM40-A		—	
	Micro mist separator	AFD20-A (with bowl guard)			AFD30-A		AFD40-A		—	
	Micro mist separator with pre-filter	—						AMH350C	AMH450C	
	Regulator (Type V only) ^{Note 1)}	AR20-B ^{Note 2)}		AR25-B ^{Note 2)}			AR40-B ^{Note 2)}			
Spacer	Y200T-A Y200-A (Type V only)		Y300T-A Y300-A (Type V only)		Y400T-A Y400-A (Type V only)		Y400-A (Type V only)			
Range of operating conditions	Fluid	Compressed air								
	Inlet air pressure (MPa)	0.3 to 0.85				0.3 to 1.0				
	Inlet air temperature (°C)	-5 to 55 ^{Note 3)}				-5 to 50 ^{Note 3)}		5 to 50		
Standard performance conditions	Ambient temperature (°C)	-5 to 55 ^{Note 3)}				-5 to 50 ^{Note 3)}		5 to 50		
	Outlet air atmospheric pressure dew point (°C)	-15								
Standard performance conditions	Inlet air flow rate (L/min [ANR]) ^{Note 5)}	28	56	111	222	329	550	665	818	1100
	Outlet air flow rate (L/min [ANR])	25	50	100	200	300	500	600	750	1000
	Purge air flow rate (L/min [ANR]) ^{Note 6)}	3	6	11	22	29	50	65	68	100
	Inlet air pressure (MPa)	0.7								
	Inlet air temperature (°C)	25								
	Inlet air saturation temperature (°C)	25								
	Ambient temperature (°C)	25								
Dew point indicator purge air flow rate		1 L/min [ANR] (Inlet air pressure at 0.7 MPa)								
Regulator construction (Type V only)		Relief type								
Port size		1/8, 1/4		1/4, 3/8			3/8, 1/2		1/2	
Weight (kg)	Type M	0.6		1.0	1.3	1.8	1.9	2.7	3.2	3.3
	Type V	0.9		1.3	1.5	2.4	2.5	3.1	3.7	3.8

Standard Specifications/Unit [Type M, Type V] (Standard dew point: -40°C, -60°C)

Model		Standard dew point: -40°C					Standard dew point: -60°C		
		IDG30LAM4	IDG50LAM4	IDG60LAM4	IDG75LAM4	IDG100LAM4	IDG60SAM4	IDG75SAM4	IDG100SAM4
		IDG30LAV4	IDG50LAV4	IDG60LAV4	IDG75LAV4	IDG100LAV4	IDG60SAV4	IDG75SAV4	IDG100SAV4
Components	Mist separator	AFM40-A					AFM40-A		
	Micro mist separator	AFD40-A					AFD40-A		
	Regulator (Type V only) <small>Note 1)</small>	AR40-B <small>Note 2)</small>					AR40-B <small>Note 2)</small>		
	Spacer	Y400T-A Y400-A (Type V only)					Y400T-A Y400-A (Type V only)		
Range of operating conditions	Fluid <small>Note 3)</small>	Compressed air					Compressed air		
	Inlet air pressure (MPa)	0.3 to 1.0					0.3 to 1.0		
	Inlet air temperature (°C)	-5 to 50 (No freezing)					-5 to 50 (No freezing)		
	Ambient temperature (°C)	-5 to 50 (No freezing)					-5 to 50 (No freezing)		
Standard performance	Outlet air atmospheric pressure dew point (°C)	-40 <small>Note 4)</small>					-60 <small>Note 4)</small>		
	Standard performance conditions	Inlet air flow rate (L/min [ANR]) <small>Note 5)</small>	93	135	224	308	400	75	140
Outlet air flow rate (L/min [ANR])		75	110	170	240	300	50	100	150
Purge air flow rate (L/min [ANR]) <small>Note 6)</small>		18	25	54	68	100	25	40	80
Inlet air pressure (MPa)		0.7					0.7		
Inlet air temperature (°C)		25					25		
Inlet air saturation temperature (°C)		25					25		
Ambient temperature (°C)		25					25		
Dew point indicator purge air flow rate		1 L/min [ANR] (Inlet air pressure at 0.7 MPa)					1 L/min [ANR] (Inlet air pressure at 0.7 MPa)		
Regulator construction (Type V only)		Relief type							
Port size		1/4, 3/8			3/8, 1/2		3/8, 1/2		
Weight (kg)	Type M	1.8	1.9	2.6	2.8	2.9	2.6	2.8	2.9
	Type V	2.4	2.5	3.1	3.3	3.4	3.1	3.3	3.4

Note 1) For flow rate characteristics and pressure characteristics of regulator, refer to pages 593 and 594.

Note 2) It will come with Option E (With square-shaped, embedded type of a pressure regulator). Refer to page 592 for details of regulators such as set pressure range etc.

Note 3) Prevent water droplets from entering the inlet port.

Note 4) Refer to the Piping Precautions (Piping material for low dew point air) on page 251.

Note 5) "ANR" indicates the flow rate converted to the value at 20°C, under the atmospheric pressure and the state of relative humidity 65%.

Note 6) Includes 1 L/min [ANR] of purge air flow (Inlet air pressure at 0.7 MPa) for the dew point indicator.

Note 7) When highly purified air is required, refer to the Design 3. on page 250.

Unit Type/Flow Rate Characteristics

Conditions: Inlet air temperature 25°C, P₁: Inlet air pressure

Standard dew point: -20°C [Symbol: Nil], -15°C [Symbol: H]

IDG3M4, 3V4 IDG3HM4, 3HV4

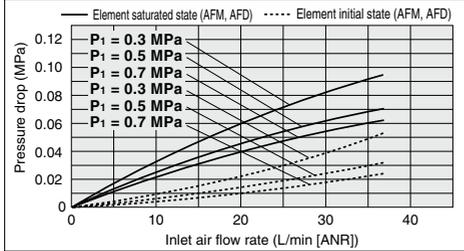

IDG5M4, 5V4 IDG5HM4, 5HV4

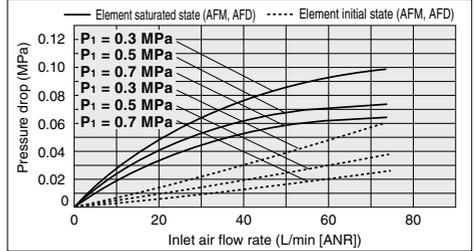

IDG10M4, 10V4 IDG10HM4, 10HV4

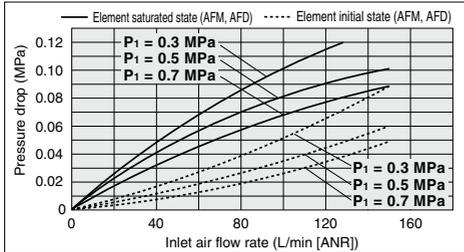

IDG20M4, 20V4 IDG20HM4, 20HV4

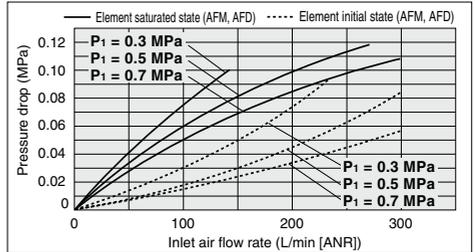

IDG30M4, IDG30HAV4

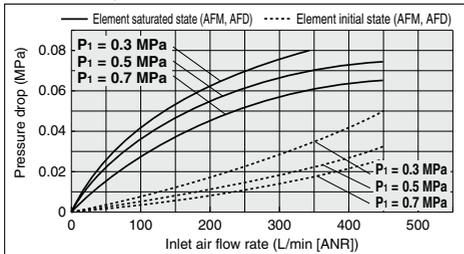

IDG50AM4, IDG50HAV4

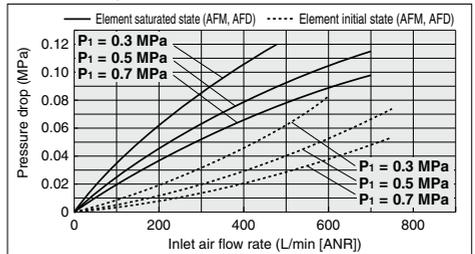

IDG60M2, 60HM2 IDG60V4, 60HV4

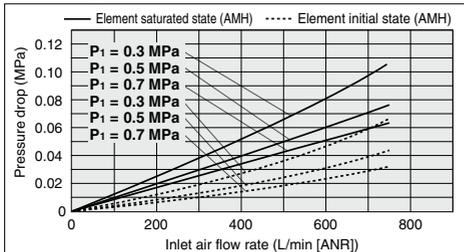

IDG75M2, 75HM2 IDG75V4, 75HV4

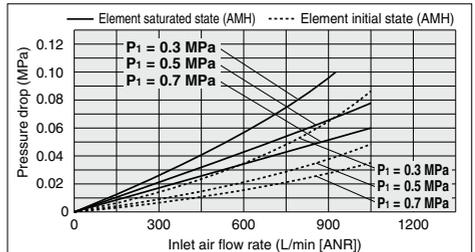

Unit Type/Flow Rate Characteristics

Conditions: Inlet air temperature 25°C, P₁: Inlet air pressure

**IDG100M2, 100HM2
IDG100V4, 100HV4**

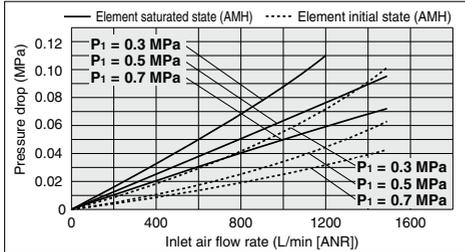

Standard dew point---40°C [Symbol: L], -60°C [Symbol: S]

IDG30LAM4, IDG30LAV4

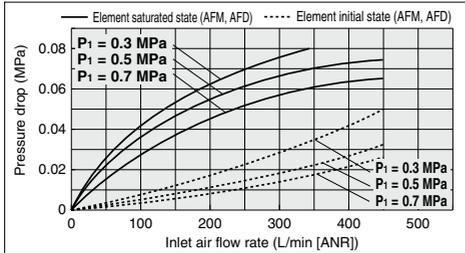

IDG50LAM4, IDG50LAV4

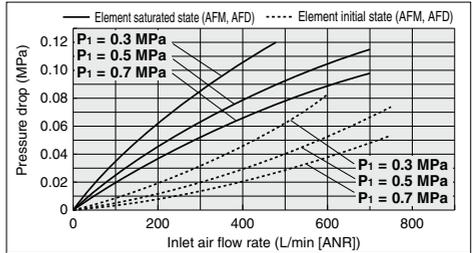

**IDG60LAM4, 60SAM4
IDG60LAV4, 60SAV4**

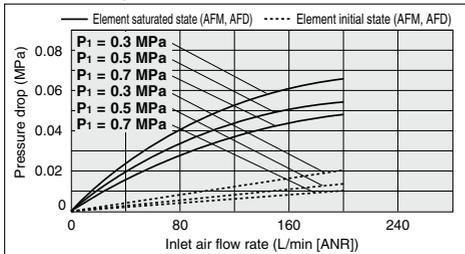

**IDG75LAM4, 75SAM4
IDG75LAV4, 75SAV4**

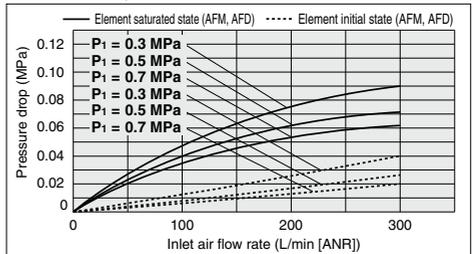

**IDG100LAM4, 100SAM4
IDG100LAV4, 100SAV4**

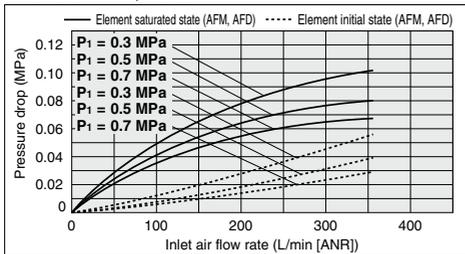

Dimensions/Type M

IDG3M4, 5M4
IDG3HM4, 5HM4

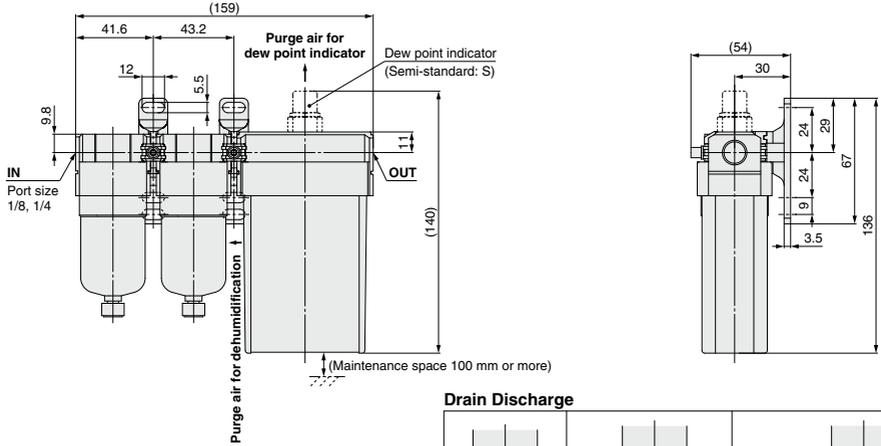

Drain Discharge

	 M5 x 0.8	 Hexagon width across flats 14 1/8 Female thread
Manual valve	Float type auto-drain N.C. type	Drain guide

With fitting for purge air discharge (Semi-standard: P)

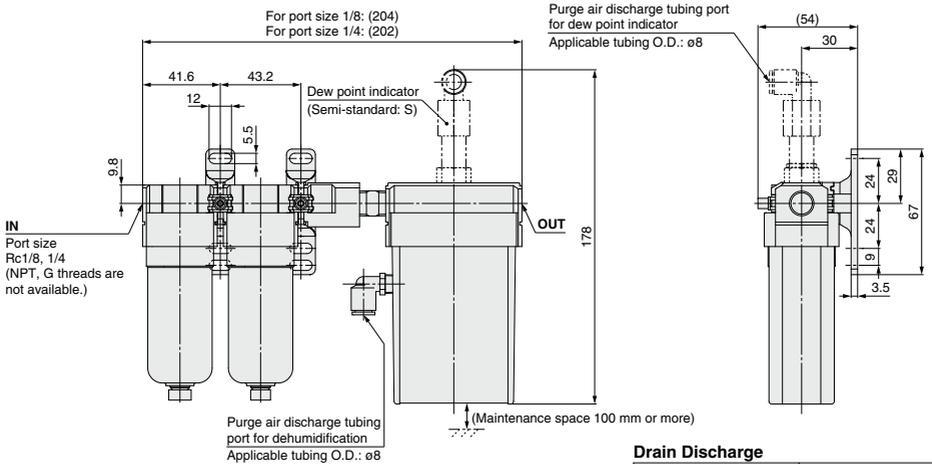

Drain Discharge

 M5 x 0.8	 Hexagon width across flats 14 Rc1/8
Float type auto-drain N.C. type	Drain guide

Dimensions/Type M

IDG10M4, 20M4
IDG10HM4, 20HM4

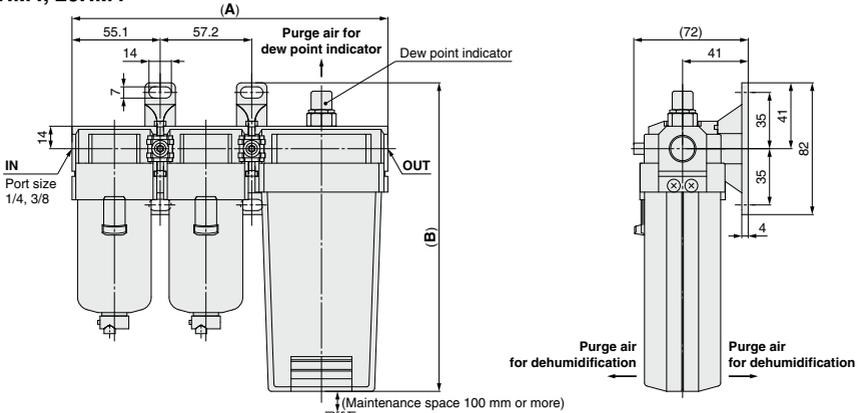

Model	A	B
IDG10M4, 10HM4	197	192
IDG20M4, 20HM4	227	217

Drain Discharge

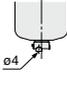
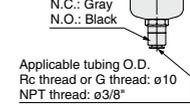
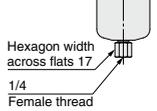
	 N.C.: Gray N.O.: Black Applicable tubing O.D. Rc thread or G thread: $\phi 10$ NPT thread: $\phi 3/8^*$	 Hexagon width across flats 17 1/4 Female thread
Manual valve (With drain discharge valve)	Float type auto-drain N.C. type N.O. type	Drain guide (Without drain discharge valve)

With fitting for purge air discharge (Semi-standard: P)

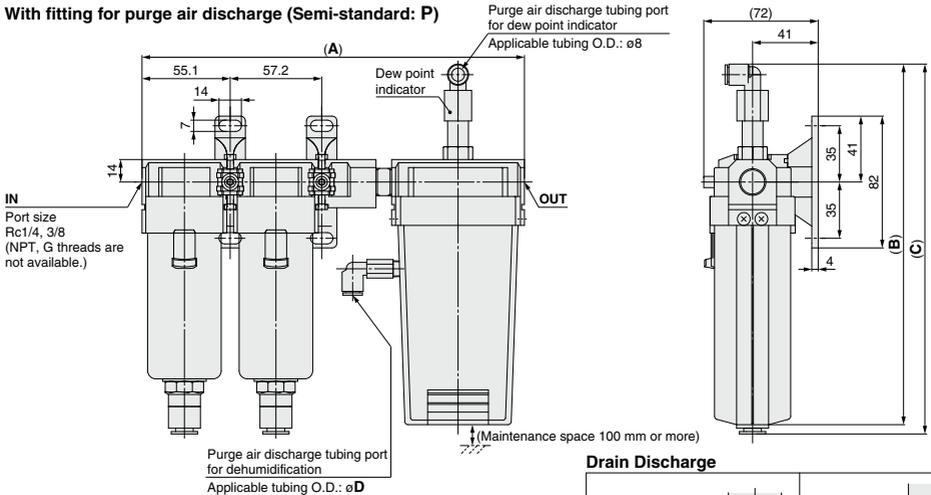

Model	Port size	A	B	C
IDG10M4, 10HM4	1/4	242	225	231
	3/8	243		
IDG20M4, 20HM4	1/4	272	250	—
	3/8	273		

Drain Discharge

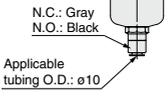
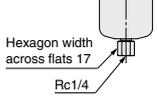
 N.C.: Gray N.O.: Black Applicable tubing O.D.: $\phi 10$	 Hexagon width across flats 17 Rc1/4
Float type auto-drain N.C. type N.O. type	Drain guide (Without drain discharge valve)

Dimensions/Type M

IDG30□AM4
IDG50□AM4
IDG60□AM4
IDG75□AM4
IDG100□AM4

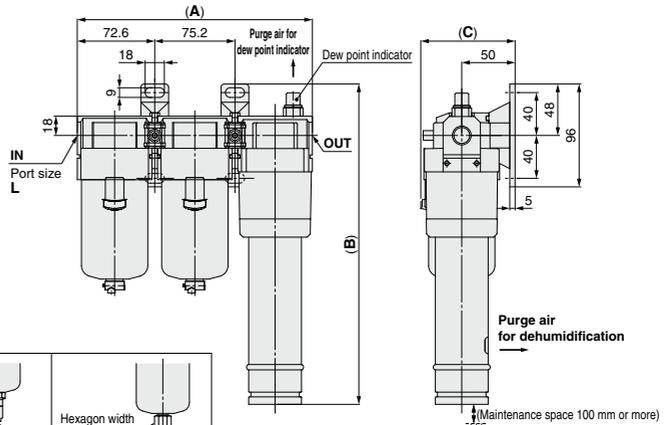

Drain Discharge

	N.C.: Gray N.O.: Black Applicable tubing O.D. Rc thread or G thread: $\phi 10$ NPT thread: $\phi 3/8"$	
Manual valve (With drain discharge valve)	Float type auto-drain N.C. type N.O. type	Drain guide (Without drain discharge valve)

Hexagon width across flats 17
1/4 Female thread

With fitting for purge air discharge (Semi-standard: P)

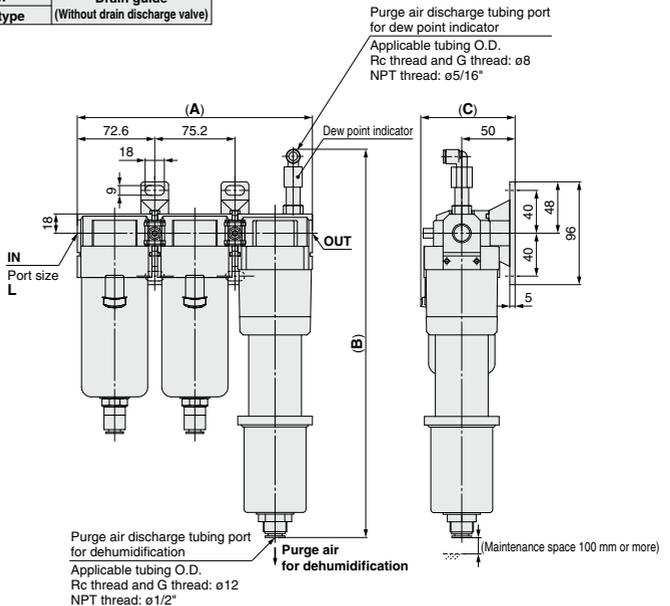
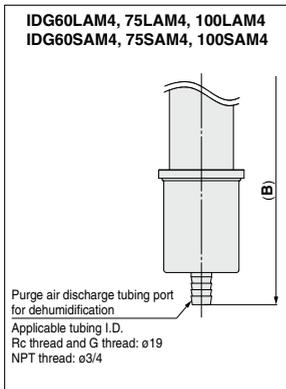

Drain Discharge

	N.C.: Gray N.O.: Black Applicable tubing O.D. Rc thread or G thread: $\phi 10$ NPT thread: $\phi 3/8"$	
Float type auto-drain N.C. type N.O. type	Drain guide (Without drain discharge valve)	

Hexagon width across flats 17
1/4 Female thread

Model	Port size L	A	B		C
			Standard	Semi-standard: P	
IDG30□AM4	1/4, 3/8	220	299	362	88
IDG50□AM4			338	401	
IDG60LAM4, 60SAM4			356	427	
IDG75LAM4, 75SAM4	3/8, 1/2	232	426	496	91
IDG100LAM4, 100SAM4			491	561	

Dimensions/Type M

IDG60□M2
IDG75□M2
IDG100□M2

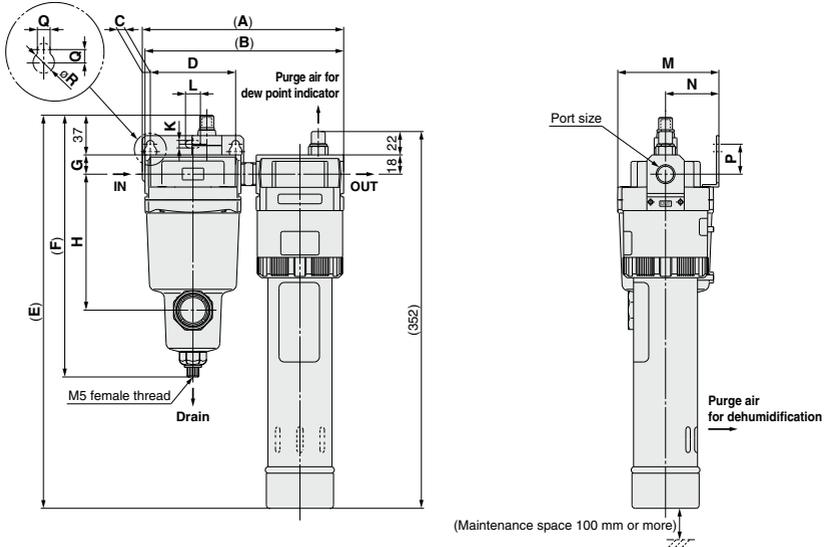

**With fitting for purge air discharge
(Semi-standard: P)**

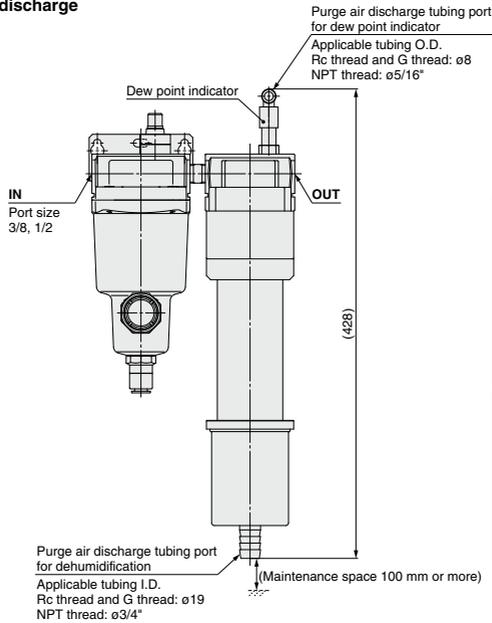

Drain Discharge

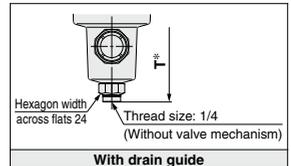
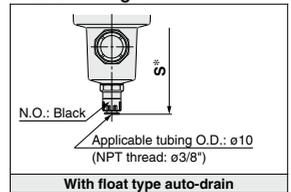

* Total length of the separator

Model	Port size	A	B	C	D	E	F	G	H	K	L	M	N	P	Q	R	With float type auto-drain	With drain guide
																	S	T
IDG60□M2	3/8, 1/2	189	186	7.5	80	367	244	18	127	7	14	95	50	28	7	12	255	241
IDG75□M2	1/2	206	204	10.5	90	369	262	20	146	9	18	108	55	31	9	15	276	262
IDG100□M2																		

Dimensions/Type V

**IDG3V4, 5V4
IDG3HV4, 5HV4**

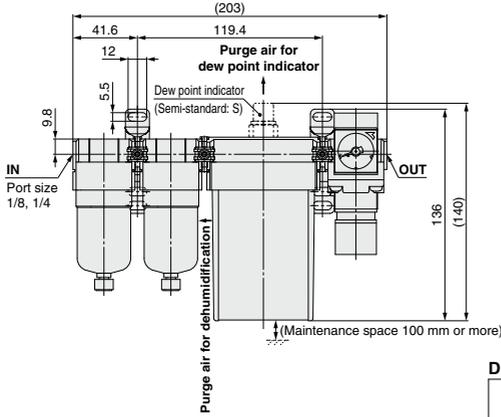

Drain Discharge

Manual valve	Float type auto-drain N.C. type	Drain guide

**IDG10V4, 20V4
IDG10HV4, 20HV4**

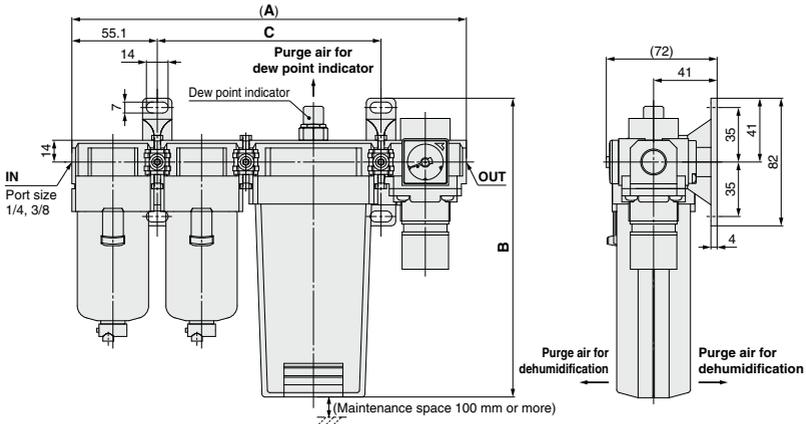

Drain Discharge

Manual valve (With drain discharge valve)	Float type auto-drain N.C. type	Drain guide (Without drain discharge valve)

Model	A	B	C
IDG10V4, 10HV4	255	192	144.4
IDG20V4, 20HV4	285	217	174.4

Dimensions/Type V

IDG30□AV4
IDG50□AV4
IDG60□AV4
IDG75□AV4
IDG100□AV4

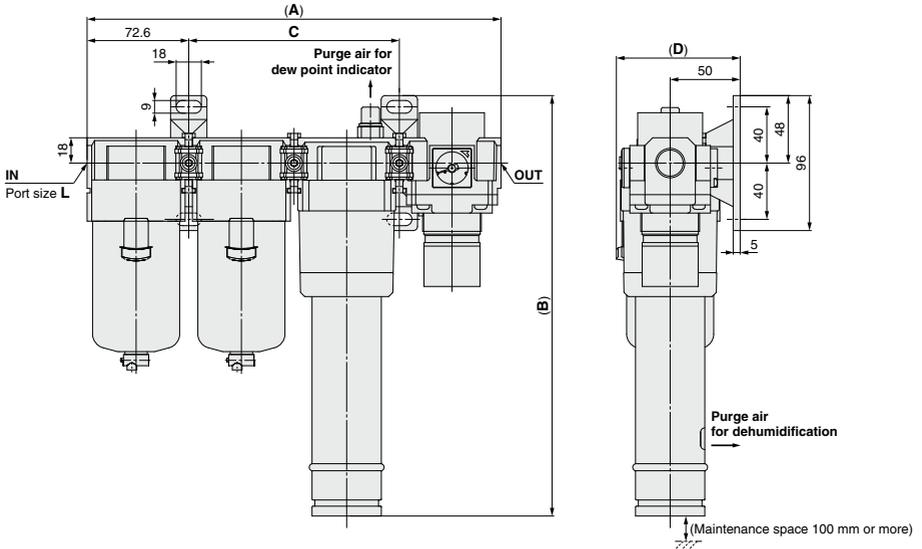

Model	Port size	A	B	C	D
	L				
IDG30□AV4	1/4, 3/8	296	299	150.4	88
IDG50□AV4		338			
IDG60LAV4, 60SAV4	3/8, 1/2	356			
IDG75LAV4, 75SAV4		426	162.4	91	
IDG100LAV4, 100SAV4		491			

Drain Discharge

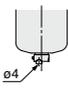
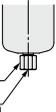
 Manual valve (With drain discharge valve)	 N.C.: Gray N.O.: Black	 Hexagon width across flats 17 1/4 Female thread
	Applicable tubing O.D. Rc thread or G thread: $\phi 10$ NPT thread: $\phi 3/8$ "	
	Float type auto-drain	
	N.C. type	N.O. type
	Drain guide (Without drain discharge valve)	

Dimensions/Type V

IDG60V4, 75V4, 100V4

IDG60HV4, 75HV4, 100HV4

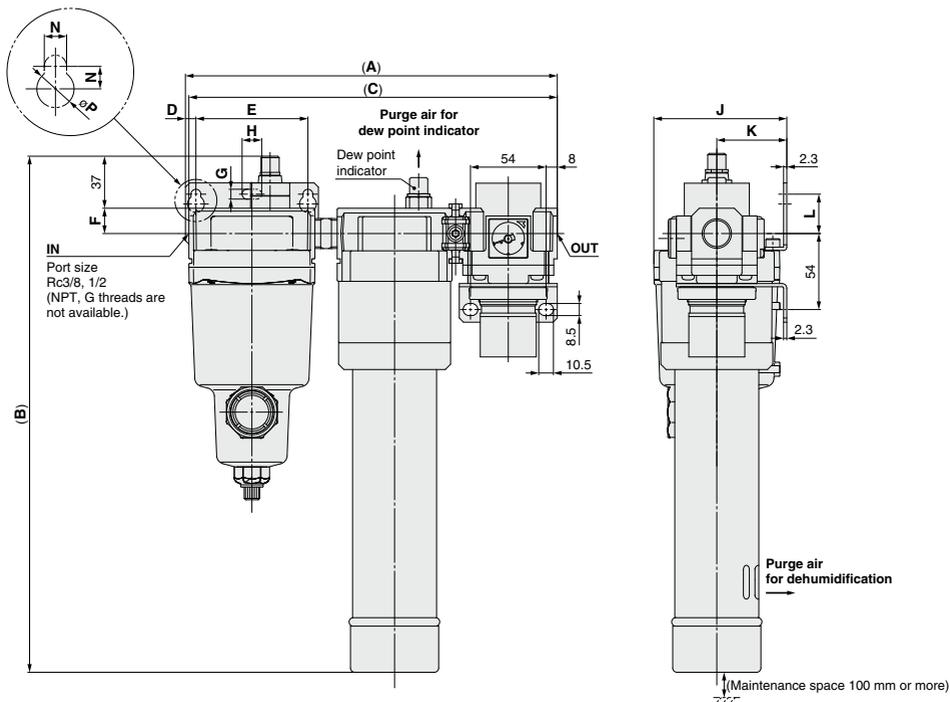

Drain Discharge

<p>M5 female thread</p>	<p>N.O.: Black Applicable tubing O.D.: ø10</p>	<p>Hexagon width across flats 24 1/4 Female thread</p>
Manual valve	Float type auto-drain N.O. type	Drain guide (Without drain discharge valve)

Model	Port size	A	B	C	D	E	F	G	H	J	K	L	N	P
IDG60V4, 60HV4	3/8	264	367	261	7.5	80	18	7	14	95	50	28	7	12
	1/2	266		263										
IDG75V4, 75HV4	1/2	281	369	279	10.5	90	20	9	18	108	55	31	9	15
IDG100V4, 100HV4														

Bowl Assembly, Pressure Gauge/Part No.

Description		IDG3M4	IDG3HM4	IDG5M4	IDG5HM4	IDG10M4	IDG10HM4	IDG20M4	IDG20HM4	IDG30AM4	IDG30HAM4	IDG50AM4	IDG50HAM4
		IDG3V4	IDG3HV4	IDG5V4	IDG5HV4	IDG10V4	IDG10HV4	IDG20V4	IDG20HV4	IDG30AV4	IDG30HAV4	IDG50AV4	IDG50HAV4
Float type	N.C.	AD27-C-A				AD37-A				AD47-A			
auto-drain	N.O.	—				AD38-A				AD48-A			
Pressure gauge (Type V only)		GC3-10AS											

Description		IDG60M2	IDG60HM2	IDG75M2	IDG75HM2	IDG100M2	IDG100HM2	
		IDG60V4	IDG60HV4	IDG75V4	IDG75HV4	IDG100V4	IDG100HV4	
Bowl assembly (N.O.)		AM-CA350C-D			AM-CA450C-D			
Pressure gauge (Type V only)		GC3-10AS						

Description		IDG30LAM4	IDG50LAM4	IDG60LAM4	IDG60SAM4	IDG75LAM4	IDG75SAM4	IDG100LAM4	IDG100SAM4	
		IDG30LAV4	IDG50LAV4	IDG60LAV4	IDG60SAV4	IDG75LAV4	IDG75SAV4	IDG100LAV4	IDG100SAV4	
Float type	N.C.							AD47-A		
auto-drain	N.O.							AD48-A		
Pressure gauge (Type V only)		GC3-10AS								

Replacement Parts (Element for mist separator, micro mist separator, micro mist separator with pre-filter)

Description	AFM20-A	AFD20-A	AFM30-A	AFD30-A	AFM40-A	AFD40-A	AMH350C	AMH450C
Element assembly	AFM20P-060AS	AFD20P-060AS	AFM30P-060AS	AFD30P-060AS	AFM40P-060AS	AFD40P-060AS	AMH-EL350	AMH-EL450



Symbol (Type M)

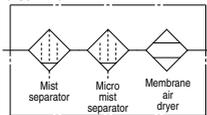

**IDG60 to 100M2
IDG60H to 100HM2**

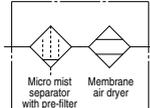

(Type V)

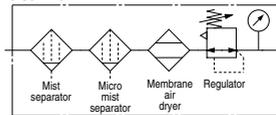

**IDG60 to 100V4
IDG60H to 100HV4**

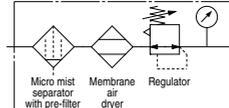

Clogging Indication

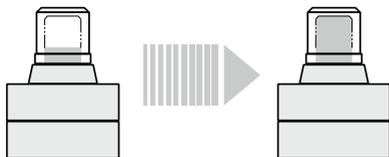

When the differential air is 0.05 MPa or less
(The tip of the indicator is just visible.)

When the differential air is 0.1 MPa or more
(The indicator is completely up to the top.)

Replace the element when the element service indicator's red indication reaches completely to the top.

The top of the indication window shows differential pressure of approximately 0.1 MPa. Replace the element after two years of use, even if the element service indicator's red indication does not reach the top.

The element service indicator is shipped mounted to the micro mist separator with pre-filter, and cannot be retrofitted or used individually.

Spacer Compatibility Chart

IDG size	Spacer		
	Y200(T)-A	Y300(T)-A	Y400(T)-A
IDG3□	●	—	—
IDG5□	●	—	—
IDG10□	—	●	—
IDG20□	—	●	—
IDG30□	—	—	●
IDG50□	—	—	●
IDG60□	—	—	●
IDG75□	—	—	●
IDG100□	—	—	●



IDG□A/IDG Series Model Selection

Step 1 Check the operating conditions.

Outlet air flow rate (L/min [ANR])
 Outlet air atmospheric pressure dew point (°C)
 (When it is necessary to convert from the pressurized dew point, refer to the conversion chart for dew point temperature below.)
 Inlet air pressure (MPa)
 Inlet air temperature (°C)
 Allowable pressure drop ΔP (MPa)
 Compressed air supply capacity Q (L/min [ANR])

[Example]
 Outlet air flow rate 150 (L/min[ANR])
 Outlet air atmospheric pressure dew point -15 (°C)
 Inlet air pressure 0.5 (MPa)
 Inlet air temperature 35 (°C)
 Allowable pressure drop 0.03 (MPa)
 Compressed air supply capacity 300 (L/min [ANR])

Dew Point Temperature Conversion Chart

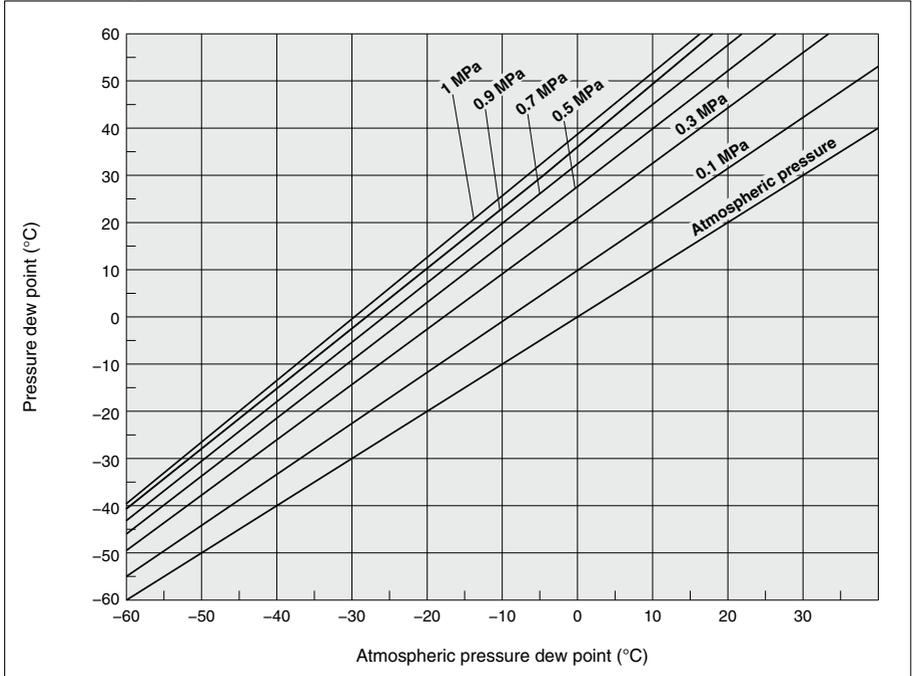

Step 2 Correction of the outlet air flow rate influenced by the inlet air temperature

(When the inlet air temperature is 25°C, proceed to **Step 4**)

When the inlet air temperature is not the same temperature (25°C) on the performance charts, calculate the correction factor for the outlet air flow rate from the table below to compensate the outlet air flow rate.

Example: | From the table below (Inlet Air Temperature
- Correction Factor for Outlet Air Flow Rate),
Inlet air temperature 35°C | correction factors for outlet air flow rate are as follows.
 | IDG□A series: 0.86
 | IDG series: 0.40
 | Therefore,
 | corrected outlet air flow rate can be determined.
 | (IDG□A series) 150 ÷ 0.86 = 175 L/min [ANR]
 | (IDG series) 150 ÷ 0.4 = 375 L/min [ANR]

Inlet Air Saturation Temperature – Correction Factor for Outlet Air Flow Rate

Inlet air temperature (°C)	IDG□A series	IDG series
10	1.35	3.00
15	1.22	2.17
20	1.10	1.52
25	1.00	1.00
30	0.92	0.65
35	0.86	0.40
40	0.80	0.25
45	0.75	0.19
50	0.70	0.14

Note) Correction factors between IDG□A series and IDG series are different from each other, because the membrane module characteristics are different.

Step 3 Model selection based on corrected outlet air flow rate

Based on the corrected outlet air flow rate calculated by **Step 2**, select a model from the performance charts on pages 210 and 211.

Example: | With the conditions of the corrected outlet air flow rate and the inlet air pressure mentioned to the left, when selecting a model which satisfies the specifications that the outlet air atmospheric pressure dew point -15°C or less,
Corrected outlet air flow rate 175 L/min [ANR] (IDG□A series) |
Corrected outlet air flow rate 375 L/min [ANR] (IDG series) | (IDG□A series) IDG30A, IDG50HA
Inlet air pressure 0.5 MPa | (IDG series) IDG60
Outlet air atmospheric pressure dew point -15°C

Step 4 Check the purge air flow rate.

Read out from the purge air flow rate characteristics on page 214.

Example: |
Inlet air pressure 0.5 MPa |
Selected model IDG30A | For the IDG30A 45 L/min [ANR]
 | IDG50HA | For the IDG50HA 38 L/min [ANR]
 | IDG60 | For the IDG60 94 L/min [ANR]

Step 5 Calculate the inlet air flow rate Q₁, and check the compressed air supply capacity.

Inlet air flow rate Q₁ (L/min [ANR]) =
Outlet air flow rate (L/min [ANR]) + Purge air flow rate (L/min [ANR])

Example: Assuming that the IDG30A is chosen by **Step 4** | Inlet air flow rate Q₁ = 150 + 45 = 195 L/min [ANR]
 | Outlet air flow rate 150 L/min [ANR]
 | Purge air flow rate 45 L/min [ANR]
 | Compressed air supply capacity Q 300 L/min [ANR]

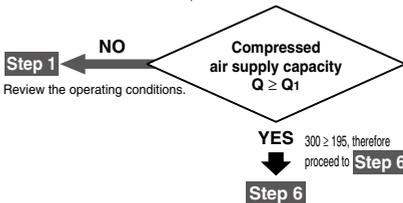

Step 6 Check the pressure drop ΔP₁ [MPa].

Single Unit (Refer to pages 212 and 213.)
Unit (Refer to pages 224 and 225.)

Example: Selected model: IDG30A | • Single Unit: IDG30A
 | Inlet air pressure 0.5 MPa | Based on the flow rate characteristics (page 212),
 | Inlet air flow rate 195 L/min [ANR] | ΔP₁ = 0.006 MPa
 | Allowable pressure drop ΔP 0.03 MPa | • Unit: IDG30AM4
 | | ΔP₁ = 0.01 MPa (Element initial state)

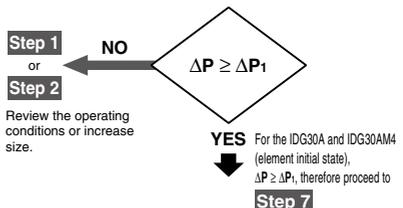

Step 7 Consider the drain discharge method (in the case of Unit), accessory and semi-standard specification.

Example: | Single Unit (Refer to pages 206 and 207.)
For the IDG30A | Unit (Refer to pages 220 and 221.)
Accessory: With bracket
Semi-standard: None
For the IDG30AM4 |
Drain discharge method: N.O. auto-drain
Semi-standard: None

Refer to **Selection** in the Specific Product Precautions 1 on page 250.

Model selected

<Single Unit>
IDG30A-03B
<Unit>
IDG30AM4-03D



Made to Order 1

Please contact SMC for detailed dimensions, specifications and lead times.



1 With Element Service Indicator

Symbol
-X016

An element service indicator is mounted on the micro mist separator with pre-filter (AMH series) to allow visual management of the element's clogging life. In addition, combination with a micro mist separator with pre-filter also provides a spatially compact design.

Element service indicator

How to Order



IDG 30 □ A M2 - □ 03 □ - □ - X016

Size ●
30
50
60
75
100

● With element service indicator

● Semi-standard

Symbol	Specifications
Nil	None (Standard)
R	Flow direction (Right → Left)



Standard dew point temperature/Outlet air flow rate ●

Symbol	Standard dew point (°C)	Flow rate by size, Outlet air flow rate (L/min [ANR])				
		30	50	60	75	100
Nil	-20	300	500	—	—	—
H	-15	300	500	—	—	—
L	-40	75	110	170	240	300
S	-60	—	—	—	—	150

● Drain discharge method

Symbol	Drain discharge method
Nil	Manual valve
C	N.C. auto-drain
D	N.O. auto-drain
J	Drain guide (Port size 1/4 without valve)

* For model selection of an auto-drain, refer to the Selection Precautions on page 250.

● Thread type

Symbol	Type
Nil	Rc
N	NPT
F	G

● Port size

Symbol	Port size	30			50			60	75	100	
		Nil	H	L	Nil	H	L	L	L	L	S
02	1/4	●	●	●	—	—	●	—	—	—	—
03	3/8	●	●	—	●	●	—	●	●	●	●

● Components

Components	30			50			60	75	100	
	Nil	H	L	Nil	H	L	L	L	L	S
Micro mist separator with pre-filter (AMH)	AMH250C	AMH150C	AMH350C	AMH150C	AMH250C	AMH250C	AMH250C	AMH250C	AMH250C	AMH250C

Replacement Parts (Element for micro mist separator with pre-filter)

Description	AMH150C	AMH250C	AMH350C
Element assembly	AMH-EL150	AMH-EL250	AMH-EL350

Refer to page 234 for the clogging indication of the element service indicator.

How to Order

IDG 10 **M2** - **02** - - **X016**

● **Size**

3
5
10
20

● **Standard dew point temperature/Outlet air flow rate**

Symbol	Standard dew point (°C)	Flow rate by size		Outlet air flow rate (L/min [ANR])	
		3	5	10	20
Nil	-20	25	50	100	200
H	-15	25	50	100	200

● **With element service indicator**

● **Semi-standard**

Symbol	Specifications	Size			
		3	5	10	20
Nil	None (Standard)	●	●	●	●
R	Flow direction (Right → Left)	●	●	●	●
S	With dew point indicator	●	●	Standard equipment	●

● **Drain discharge method**

Symbol	Drain discharge method	Size			
		3	5	10	20
Nil	Manual valve	●	●	●	●
C	N.C. auto-drain	●	●	●	●
J	Drain guide (Port size 1/4 without valve)	—	—	●	●

* For model selection of an auto-drain, refer to the Selection Precautions on page 250.

* Drain discharge method does not need to be selected for N.O. auto-drain type.

● **Port size**

Symbol	Port size	3		5		10		20	
		Nil	H	Nil	H	Nil	H	Nil	H
01	1/8	●	●	●	●	—	—	—	—
02	1/4	●	●	●	●	●	●	●	●
03	3/8	—	—	—	—	—	—	●	●

● **Thread type**

Symbol	Type
Nil	Rc
N	NPT
F	G

● **Components**

Components	3		5		10		20	
	Nil	H	Nil	H	Nil	H	Nil	H
Micro mist separator with pre-filter (AMH)	AMH150C						AMH250C	

Replacement Parts (Element for micro mist separator with pre-filter)

Description	AMH150C	AMH250C
Element assembly	AMH-EL150	AMH-EL250

Refer to page 234 for the clogging indication of the element service indicator.

Dimensions

IDG3M2, 5M2, 10M2, 20M2
IDG3HM2, 5HM2, 10HM2, 20HM2

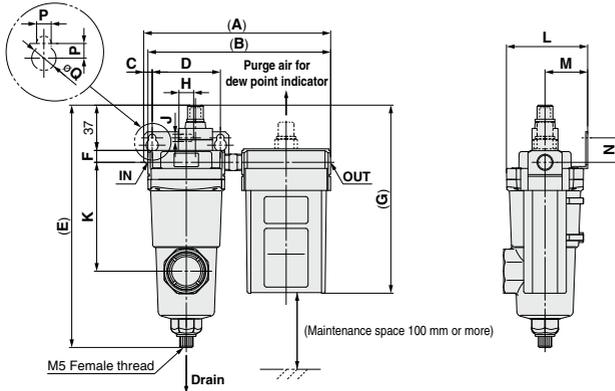

IDG30AM2, 50AM2
IDG30HAM2, 50HAM2
IDG30LAM2, 50LAM2

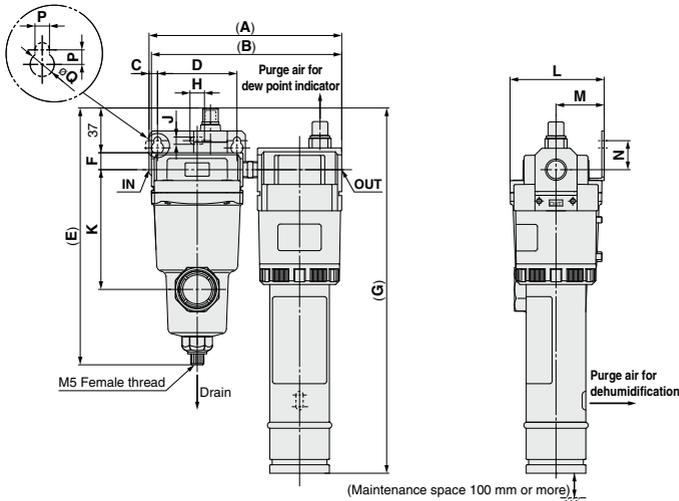

Drain Discharge

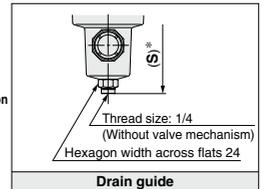
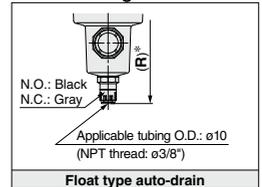

* Total length of the separator

Model	Port size	A	B	C	D	E	F	G	H	J	K	L	M	N	P	Q	With float type auto-drain	With drain guide
																	R	S
IDG3M2, 3HM2, 5M2, 5HM2	1/8	155.5	152	7	56	198	10	154	12	6	89	66.5	35	20	6	10	209	—
	1/4	153.5	150															198
IDG10M2, 10HM2	1/4	163.5	160	7	66	212	14	227	12	6	99	78	40	24	6	10	223	209
	3/8	205	203															302
IDG20M2, 20HM2	3/8	206	204	7	66	212	14	227	12	6	99	78	40	24	6	10	223	209
IDG30AM2, 30HAM2	1/4, 3/8	160	158	7	66	212	14	227	12	6	99	78	40	24	6	10	223	209
IDG30LAM2	1/4	150.5	147	7	56	198	10	298	12	6	89	69	35	20	6	10	209	195
IDG50AM2, 50HAM2	3/8	175	172	7.5	80	244	18	345	14	7	127	95	50	28	7	12	255	241
IDG50LAM2	1/4	150.5	147	7	56	198	10	337	12	6	89	69	35	20	6	10	209	195

Dimensions

IDG60LAM2

IDG75LAM2

IDG100LAM2, IDG100SAM2

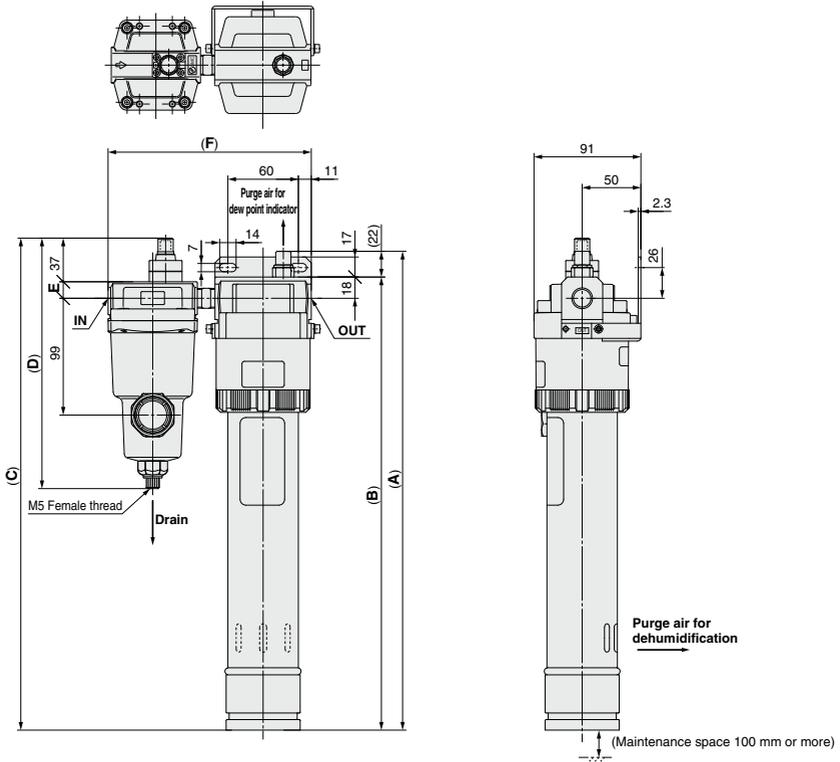

Drain Discharge

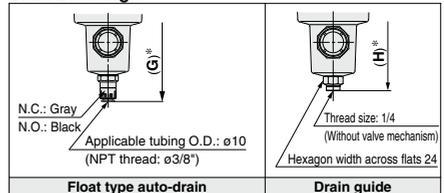

* Total length of the separator

Model	Port size	A	B	C	D	E	F	With float type auto-drain	With drain guide
								G	H
IDG60LAM2	3/8	348	326	359					
IDG75LAM2		418	396	429	212	14	170	223	209
IDG100LAM2, IDG100SAM2		483	461	494					



IDG□A/IDG Series

Made to Order 2

Please contact SMC for detailed dimensions, specifications and lead times.



2 With Micro Mist Separator Regulator (AWD Series)

Symbol
-X017

This can be used when highly purified air is required (supply for air bearings, semiconductor parts blow, etc.). Unit Type V regulator (AR) is changed to the micro mist separator regulator (AWD).

Micro mist separator regulator

How to Order



IDG 30 □ A V4 - □ 03 □ - □ - X017

Size

30
50
60
75
100

Standard dew point temperature/Outlet air flow rate

Symbol	Standard dew point (°C)	Flow rate by size, Outlet air flow rate (L/min [ANR])				
		30	50	60	75	100
Nil	-20	300	500	—	—	—
H	-15	300	500	—	—	—
L	-40	75	110	170	240	300
S	-60	—	—	50	100	150

Thread type

Symbol	Type
Nil	Rc
N	NPT
F	G

Port size

Symbol	Port size	30			50			60		75		100	
		Nil	H	L	Nil	H	L	L	S	L	S	L	S
02	1/4	●	●	●	●	●	●	—	—	—	—	—	—
03	3/8	●	●	●	●	●	●	—	—	—	●	●	●
04	1/2	—	—	—	—	—	—	●	●	●	●	●	●

Components

Components	30			50			60		75		100	
	Nil	H	L	Nil	H	L	L	S	L	S	L	S
Mist separator							AFM40-A					
Micro mist separator							AFD40-A					
Micro mist separator regulator							AWD40					

Semi-standard

Symbol	Specifications
Nil	None (Standard)
R	Flow direction (Right → Left)

Drain discharge method

Symbol	Drain discharge method
Nil	Manual valve
C	N.C. auto-drain
D	N.O. auto-drain
J	Drain guide (Port size 1/4 without valve)

* For model selection of an auto-drain, refer to the Selection Precautions on page 250.



With micro mist separator regulator

Replacement Parts (Element for mist separator, micro mist separator, micro mist separator regulator)

Description	AFM40-A	AFD40-A	AWD40
Element assembly	AFM40P-060AS	AFD40P-060AS	AFD40P-060AS

How to Order

IDG 10 □ V4 - □ 02 □ - □ - X017

● **Size**

3
5
10
20

● **Standard dew point temperature/Outlet air flow rate**

Symbol	Standard dew point (°C)	Flow rate by size, Outlet air flow rate (L/min [ANR])			
		3	5	10	20
Nil	-20	25	50	100	200
H	-15	25	50	100	200

● **With micro mist separator regulator**

● **Semi-standard**

Symbol	Specifications	Size			
		3	5	10	20
Nil	None (Standard)	●	●	●	●
R	Flow direction (Right → Left)	●	●	●	●
S	With dew point indicator	●	●	●	Standard equipment

● **Drain discharge method**

Symbol	Drain discharge method
Nil	Manual valve
C	N.C. auto-drain
D	N.O. auto-drain
J	Drain guide

* For model selection of an auto-drain, refer to the Selection Precautions on page 250.

● **Port size**

Symbol	Port size	3		5		10		20	
		Nil	H	Nil	H	Nil	H	Nil	H
01	1/8	●	●	●	●	—	—	—	—
02	1/4	●	●	●	●	●	●	●	●
03	3/8	—	—	—	—	●	●	●	●

● **Thread type**

Symbol	Type
Nil	Rc
N	NPT
F	G

● **Components**

Components	3		5		10		20	
	Nil	H	Nil	H	Nil	H	Nil	H
Mist separator	AFM20-A				AFM30-A			
Micro mist separator	AFD20-A				AFD30-A			
Micro mist separator regulator	AWD20				AWD30			

Replacement Parts (Element for mist separator, micro mist separator, micro mist separator regulator)

Description	AFM20-A	AFM30-A	AFD20-A	AFD30-A	AWD20	AWD30
Element assembly	AFM20P-060AS	AFM30P-060AS	AFD20P-060AS	AFD30P-060AS	AFD20P-060AS	AFD30P-060AS

Dimensions

IDG3V4, 5V4, 10V4, 20V4

IDG3HV4, 5HV4, 10HV4, 20HV4

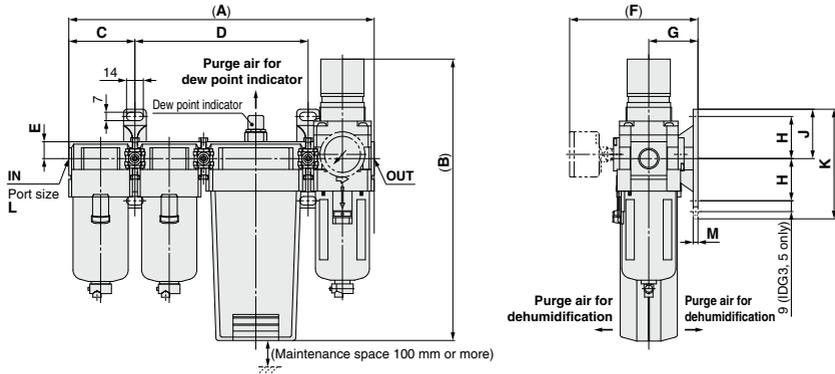

Drain Discharge (IDG3□V4, 5□V4)

	 M5 x 0.8	 1/8 Female thread Hexagon width across flats 14
Manual valve	Float type auto-drain N.C. type	Drain guide (Without drain discharge valve)

Drain Discharge (IDG10□V4, 20□V4)

 ø4	 N.C.: Gray N.O.: Black Applicable tubing O.D. Pc thread or G thread: ø10 NPT thread: ø3/8"	 1/4 Female thread Hexagon width across flats 17
Manual valve (With drain discharge valve)	Float type auto-drain N.C. type	Drain guide (Without drain discharge valve)

Model	Port size L	A	B	C	D	E	F	G	H	J	K	M
IDG3V4, 3HV4, 5V4, 5HV4	1/8, 1/4	203	180	41.6	119.4	9.8	93	30	24	29	67	3.5
IDG10V4, 10HV4	1/4, 3/8	255	237	55.1	144.4	14	107	41	35	41	82	4
IDG20V4, 20HV4		285	262		174.4							

Dimensions

IDG30AV4, 50AV4

IDG30HAV4, 50HAV4

IDG30LAV4, 50LAV4, 60LAV4, 75LAV4, 100LAV4

IDG60SAV4, 75SAV4, 100SAV4

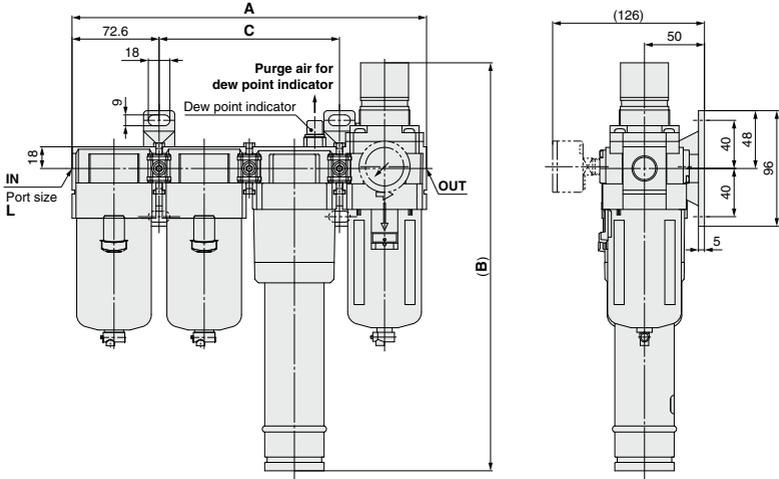

Drain Discharge

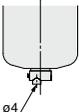
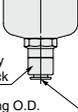
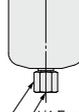
		
	N.C.: Gray N.O.: Black	
	Applicable tubing O.D. Rc thread or G thread: $\phi 10$ NPT thread: $\phi 3/8"$	
		1/4 Female thread Hexagon width across flats 17
Manual valve (With drain discharge valve)	Float type auto-drain	
	N.C. type	N.O. type
	Drain guide (Without drain discharge valve)	

Model	Port size L	A	B	C
IDG30□AV4	1/4, 3/8	296	343	150.4
IDG50□AV4		382		
IDG60LAV4, 60SAV4	3/8, 1/2	308	400	162.4
IDG75LAV4, 75SAV4		470		
IDG100LAV4, 100SAV4		535		



Made to Order 3

Please contact SMC for detailed dimensions, specifications and lead times.



3 With Differential Pressure Gauge

Symbol
-X032

The service life of the element service indicator can be controlled with differential pressure.

Differential pressure gauge



How to Order



IDG **30** **A** V4 - **03** - **X032**

Size

30
50
60
75
100

With differential pressure gauge

Semi-standard

Symbol	Specifications
Nil	None (Standard)
R	Flow direction (Right → Left)

Standard dew point temperature/Outlet air flow rate

Symbol	Standard dew point (°C)	Flow rate by size, Outlet air flow rate (L/min [ANR])				
		30	50	60	75	100
Nil	-20	300	500	—	—	—
H	-15	300	500	—	—	—
L	-40	75	110	170	240	300
S	-60	—	—	50	100	150

Drain discharge method

Symbol	Drain discharge method	Note
Nil	Manual valve	—
C	N.C. auto-drain	Auto-drains listed on page 233 are attached.
D	N.O. auto-drain	
J	Drain guide	—

* For model selection of an auto-drain, refer to the Selection Precautions on page 250.

Thread type

Symbol	Type
Nil	Rc
N	NPT
F	G

Port size

Symbol	Port size	30			50			60		75		100	
		Nil	H	L	Nil	H	L	L	S	L	S	L	S
02	1/4	●	●	●	●	●	●	—	—	—	—	—	—
03	3/8	●	●	●	●	●	●	●	●	●	●	●	●
04	1/2	—	—	—	—	—	—	●	●	●	●	●	●

Components

Components	30			50			60		75		100	
	Nil	H	L	Nil	H	L	L	S	L	S	L	S
Mist separator	AFM40-A											
Micro mist separator	AFD40-A											
Differential pressure gauge	GD40-2-01-X29											
Regulator	AR40-B											

Replacement Parts (Element for mist separator, micro mist separator)

Description	AFM40-A	AFD40-A
Element assembly	AFM40P-060AS	AFD40-060AS

How to Order

IDG 10 □ **V4** - □ 02 □ - □ - **X032**

● **Size**

3
5
10
20

● **Standard dew point temperature/Outlet air flow rate**

Symbol	Standard dew point (°C)	Flow rate by size, 3	Flow rate by size, 5	Flow rate by size, 10	Flow rate by size, 20
Nil	-20	25	50	100	200
H	-15	25	50	100	200

● **With differential pressure gauge**

● **Semi-standard**

Symbol	Specifications	Size			
		3	5	10	20
Nil	None (Standard)	●	●	●	●
R	Flow direction (Right → Left)	●	●	●	●
S	With dew point indicator	●	●	Standard equipment	

● **Drain discharge method**

Symbol	Drain discharge method	Note
Nil	Manual valve	—
C	N.C. auto-drain	Auto-drains listed on page 233 are attached.
D	N.O. auto-drain	
J	Drain guide	—

* For model selection of an auto-drain, refer to the Selection Precautions on page 250.

● **Port size**

Symbol	Port size	3		5		10		20	
		Nil	H	Nil	H	Nil	H	Nil	H
01	1/8	●	●	●	●	—	—	—	—
02	1/4	●	●	●	●	●	●	●	●
03	3/8	—	—	—	—	●	●	●	●

● **Thread type**

Symbol	Type
Nil	Rc
N	NPT
F	G

● **Components**

Components	3		5		10		20	
	Nil	H	Nil	H	Nil	H	Nil	H
Mist separator	AFM20-A				AFM30-A			
Micro mist separator	AFD20-A				AFD30-A			
Differential pressure gauge	GD40-2-01-X29							
Regulator	AR20-B				AR25-B			

Replacement Parts (Element for mist separator, micro mist separator)

Description	AFM20-A	AFM30-A	AFD20-A	AFD30-A
Element assembly	AFM20P-060AS	AFM30P-060AS	AFD20P-060AS	AFD30P-060AS

Dimensions

IDG3V4, 5V4, 10V4, 20V4

IDG3HV4, 5HV4, 10HV4, 20HV4

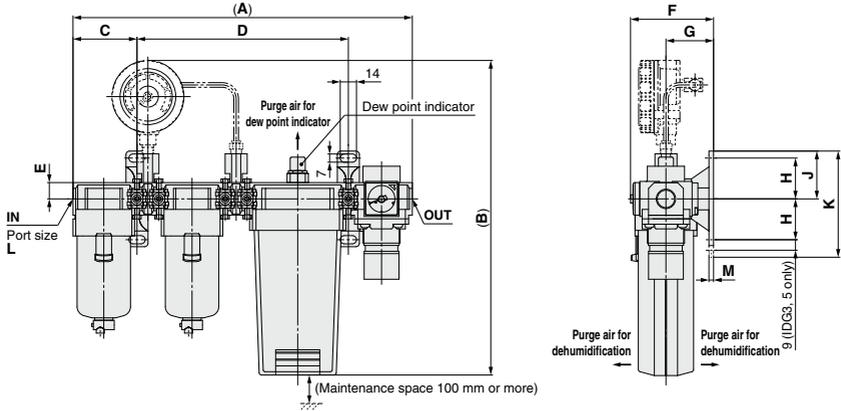

Drain Discharge (IDG3□V4, 5□V4)

Manual valve	Float type auto-drain N.C. type	Drain guide (Without drain discharge valve)

Manual valve: $\phi 4$
 Float type auto-drain N.C. type: M5 x 0.8
 Drain guide: 1/8 Female thread, Hexagon width across flats 14

Drain Discharge (IDG10□V4, 20□V4)

Manual valve (With drain discharge valve)	Float type auto-drain N.C. type N.O. type	Drain guide (Without drain discharge valve)

Manual valve: $\phi 4$
 Float type auto-drain N.C. type: N.C.: Gray, N.O.: Black, Applicable tubing O.D. Rc thread or G thread: $\phi 10$, NPT thread: $\phi 3/8"$
 Drain guide: 1/4 Female thread, Hexagon width across flats 17

Model	Port size L	A	B	C	D	E	F	G	H	J	K	M
IDG3V4, 3HV4, 5V4, 5HV4	1/8, 1/4	238	219	41.6	155	9.8	60	30	24	29	67	3.5
IDG10V4, 10HV4	1/4, 3/8	292	270	55.1	182	14	72	41	35	41	82	4
IDG20V4, 20HV4		322	295		212							

Dimensions

IDG30AV4, 50AV4

IDG30HAV4, 50HAV4

IDG30LAV4, 50LAV4, 60LAV4, 75LAV4, 100LAV4

IDG60SAV4, 75SAV4, 100SAV4

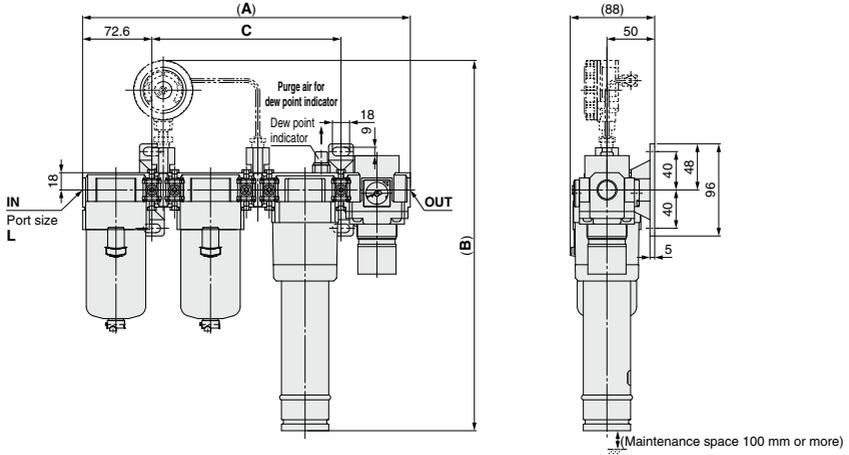

Drain Discharge

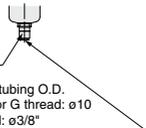
	 <p>N.C.: Gray N.O.: Black</p> <p>Applicable tubing O.D. Rc thread or G thread: $\phi 10$ NPT thread: $\phi 3/8"$</p>		 <p>Hexagon width across flats 17</p> <p>1/4 Female thread</p>
	Manual valve (With drain discharge valve)	Float type auto-drain N.C. type	
	Drain guide (Without drain discharge valve)		

Model	Port size L	A	B	C
IDG30□AV4	1/4	343	387	198
IDG50□AV4	3/8		423	
IDG60LAV4, 60SAV4	3/8	355	441	210
IDG75LAV4, 75SAV4			511	
IDG100LAV4, 100SAV4			576	



Specific Product Precautions 1

Be sure to read this before handling the products. Refer to page 9 for safety instructions and pages 10 to 12 for air preparation equipment precautions.

Design

Warning

1. Depending on the model and operating conditions, the oxygen ratio of the outlet air may drop.

Do not use standard dew point -40°C (symbol: L) type, standard dew point -60°C (symbol: S) type and IDG30A, 50A, 30HA, 50HA for dehumidifying breathing air. Do not use only outlet air (dry air) in a closed room.

2. Do not exert intermittent pressure on this product.

(Example: Frequently operating solenoid valves installed on the primary side) Intermittent pressure damages the product.

Caution

1. Install a regulator on the outlet side of the membrane air dryer.

If it is installed on the inlet side, dehumidification performance will be reduced.

2. Devise a layout which considers the position of purge air discharge ports.

Purge air is humid air. Devise a layout in which purge air will not cause trouble such as corrosion or malfunction of peripheral equipment.

3. When highly purified air is required

(Supply to air bearings, blowing of semiconductor parts, etc.) Install a micro mist separator or super mist separator on the outlet side (end terminal) of the membrane air dryer (unit). Grease is applied inside a regulator used in the unit (Type V). When highly purified air is required, please either mount the above separator on the outlet side or use a made-to-order product (refer to pages 242 and 243), which is provided with a micro mist separator (AWD series) instead of a regulator.

4. Time to reach the standard dew point

A certain amount of time is required to achieve the standard dew point after the air begins flowing into the membrane air dryer. Using the times below as a guide, begin operating outlet side equipment after the standard dew point is achieved.

Standard dew point -20°C , -15°C : about 10 minutes
Standard dew point -40°C : about 30 minutes *
Standard dew point -60°C : about 60 minutes *

* This time can be shortened as described below.

- 1) Provide a valve on the outlet side of the membrane air dryer.
- 2) Supply air with the valve closed. Only purge air flows into the membrane air dryer.
- 3) After 15 minutes or more, open the valve and let air flow to the outlet side equipment.

5. Dehumidification performance when inlet air temperature changes

Performance chart shows the case at an inlet air temperature of 25°C . In other cases, refer to "Model Selection" (page 236) for proper selection.

6. Do not use for applications such as repeatedly bending or stretching (IDG1). This may cause damage to the product.

Selection

Caution

1. Consider the purge air flow rate.

Find the purge air flow rate from the charts and calculate the "required outlet air flow rate + purge air flow rate". The air supply capacity must be at least equal to the calculated flow or the required outlet air flow rate cannot be obtained.

2. Selection for a compressed air line in which a mist separator or micro mist separator is already installed

Verify the operating air flow rate and air pressure, and select a membrane air dryer in accordance with "Model Selection" (page 236). If a membrane air dryer is selected using the port size of the equipment that is already installed as a reference, it could result in the selection of a model that is too small and has an insufficient dehumidification capacity.

3. With fitting for purge air discharge (Semi-standard: P)

The dehumidification capacity decreases in proportion to the length of the tube for discharging purge air. Use a tube of the specified size and keep its length within 5 meters. For the outlet air atmospheric pressure dew point in relation to the length of the tube for discharging purge air, refer to the table "regarding the outlet air atmospheric dew point in relation to the tube length for purge air discharge" on page 213.

4. Auto-drain selection for the unit type

When the compressor in use is for 2.2 kW (300 L/min [ANR]) or less, use an N.C. auto-drain (symbol: C). If an N.O. auto-drain (symbol: D) is used when the compressor is for 2.2 kW or less, pressure inside the mist separator may not increase and remain in the state of blowing off. Auto-drain with differential pressure type can be used in 2.2 kW or less.

Mounting

Caution

1. Do not obstruct the purge air discharge ports.

The product may be damaged. And if purge air back pressure becomes too high or purge air stops flowing, dehumidification performance will decrease or may become impossible.

2. Be sure to install a mist separator and micro mist separator or a micro mist separator with pre-filter on the inlet side of the membrane air dryer.

If the inlet air contains oil, performance will be reduced. (A mist separator and micro mist separator or a micro mist separator with pre-filter are already installed on the unit types.)

3. Remove water droplets from the inlet air.

Take appropriate measures so that water droplets do not flow into the membrane air dryer. If water droplets flow into the membrane air dryer, the performance may lower, causing malfunction.

4. Large quantities of dust (solid foreign matter) are contained in the supply air.

When there are large quantities of dust (solid foreign matter), install an air filter or main line filter to the inlet side of the mist separator in addition to 2 above.

5. Take sufficient care in handling.

There is a danger of damage if dropped.

6. When using a fixture, fix it on the metal part of the product.

Using a fixture on the resin part may cause damage to the product.



IDG□A/IDG Series

Specific Product Precautions 2

Be sure to read this before handling the products. Refer to page 9 for safety instructions and pages 10 to 12 for air preparation equipment precautions.

Piping

⚠ Warning

1. Check for locking of case and body.

When using in a unit, be sure to set the air pressure to zero before using a mist separator or micro mist separator with modular connections. Also, confirm that the body and case are locked together with a click before starting the flow of compressed air.

2. Check for tightening of the holder.

(for IDG30A to IDG100, IDG30HA to IDG100H, IDG30LA to IDG100LA, IDG60SA to IDG100SA)

Before starting the flow of compressed air, turn the membrane air dryer's holder in its tightening direction, confirming that it is completely tightened and that the case will not come off.

3. Minimum bending radius (for IDG1)

Maintain a minimum bending radius of 35 mm or more and do not bend the sections that are within 50 mm from the nuts. Furthermore, do not twist the product.

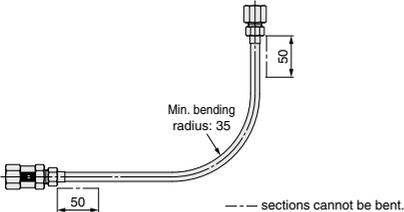

4. With fitting for purge air discharge (Semi-standard: P)

The piping of purge air for dehumidification and for the dew point indicator can be combined, but do not combine it with compressed air lines or drain piping or merge the purge air with exhaust air from other equipment. As this can cause damage.

⚠ Caution

1. Use of tools

Hold the upper portion of the body (aluminum die-casted section) with a wrench or adjustable angle wrench. Do not turn it while holding the case section.

2. Drain piping for separators

When installing drain piping for mist separators or micro mist separators, use a tube of the prescribed size and keep the length within 5 meters. Also, be sure that the tube does not rise up or become folded over.

3. Piping materials for low dew point air

If air of a low dew point (−40°C or less) is required, do not use a nylon tube piping and resin fittings (except fluoropolymer) for the outlet side of the membrane air dryer. Due to the nature of the nylon tube, it could be affected by the ambient air, and it might not be possible to achieve the prescribed low dew point at the end of the tube. Therefore, for low dew point air, use a stainless steel or fluoropolymer piping.

Piping

⚠ Caution

4. With fitting for purge air discharge (Semi-standard: P) (for IDG60 to IDG100, IDG60H to IDG100H, IDG60LA to IDG100LA, IDG60SA to IDG100SA)

To install piping for dehumidification purge air discharge, attach tubing of the prescribed size to the hose nipple section and then secure it with tubing bands.

5. Before piping is connected, flush the piping.

Be sure to remove chips, cutting oil and other debris. If they get into the product, unexpected malfunction or damage to the product may occur.

Air Supply

⚠ Caution

1. Compressed air supply capacity

An air source that has a supply capacity that is larger than the "required outlet air flow rate (dry air flow rate) + purge air flow rate" is required. Verify the purge air flow rate in "Purge Air Flow Rate Characteristics." (page 214)

2. Chemicals with a negative effect on this product

Chemicals listed in the table below in the compressed air can lower performance and damage the element. Do not use the product in environments including these chemicals.

Category	Chemicals not to be included
Solvents	Acetone, benzene, phenol, toluene, trichloroethylene, xylene, cresol, thinner, aniline, chloroform, chlorobenzene, trichloroethane, ethylbenzene, ethyl alcohol, methyl alcohol, isopropyl alcohol, dioxin, tetrahydrofuran, methylene chloride, cyclohexane, carbon tetrachloride, methyl ketone, ethyl ketone, hexafluoroisopropanol, and others
Acids	Sulfuric acid, nitric acid, hydrochloric acid, acetic acid, lactic acid, chromic acid, and others
Gases	Chlorine gas, sulfurous acid gas, hydrogen chloride, bromine, ozone, ammonia, and others
Oils	Phosphoric-ester hydraulic oil, fuel oil, water soluble cutting oil (alkaline), kerosene, and others
Strong bases	Lithium hydroxide, sodium hydroxide, potassium hydroxide, calcium hydroxide, and others
Others	Anaerobic adhesive, anaerobic sealant, and others



Specific Product Precautions 3

Be sure to read this before handling the products. Refer to page 9 for safety instructions and pages 10 to 12 for air preparation equipment precautions.

Operating Environment

Caution

1. Do not use at temperatures (fluid or ambient temperatures) higher than the prescribed operating conditions.

Resin is used in the membrane module, and it can be damaged by operation at high temperatures. Especially when installed immediately after a reciprocating type air compressor, confirm that the fluid temperature does not exceed the range of operating conditions during use.

2. Keep the inlet air temperature lower than the ambient temperature.

If the membrane air dryer body is cooled by the surrounding air, water drops may accumulate inside and reduce its dehumidification capacity.

3. Do not use in the following environments, as this can cause failure.

- 1) In locations having corrosive gases, organic solvents, and chemicals, or in locations where these elements are likely to adhere to the equipment.
- 2) In locations where salt water, water, or water vapor could come in contact with the equipment.
- 3) In locations that is exposed to shocks and vibrations.

Maintenance

Caution

1. Confirm that the equipment's pressure is at zero and no longer in a pressurized state before removing any parts or piping. Performing any work while pressure remains in the equipment may lead to injury or product damage.

2. When replacing the membrane module

For modular connections, be sure to remove the membrane air dryer before attempting any replacement work.

3. About the dew point indicator

The color of the dew point indicator shows the condition of the outlet air from the membrane air dryer.

- When the absorbent is blue or pink
 [Dew point indicator is blue] Dry state
 [Dew point indicator is pink] Wet state
- When the absorbent is green or yellow
 [Dew point indicator is green] Dry state
 [Dew point indicator is yellow] Wet state

It takes time for the dew point indicator's color to change. Absorbent is used in the dew point indicator. When it absorbs vaporized oil content or other gaseous components in the compressed air, it may turn a color other than blue (green) or pink (yellow).