

Clean Air Filter

SFD Series

RoHS

Hollow Fiber Element

- Nominal filtration rating: **0.01** μm (filtration efficiency 99.99%)
- Initial pressure drop: **0.03** MPa (at inlet pressure 0.7 MPa, maximum flow)
- Maximum operating pressure: **1.0** MPa (at 20°C)

SFD100/ **New** 110

SFD200

SFD101/102 Made to Order

Up to 100 L/min(ANR)/Up to 120 L/min(ANR)

Up to 500 L/min(ANR)

Up to 100 L/min(ANR)

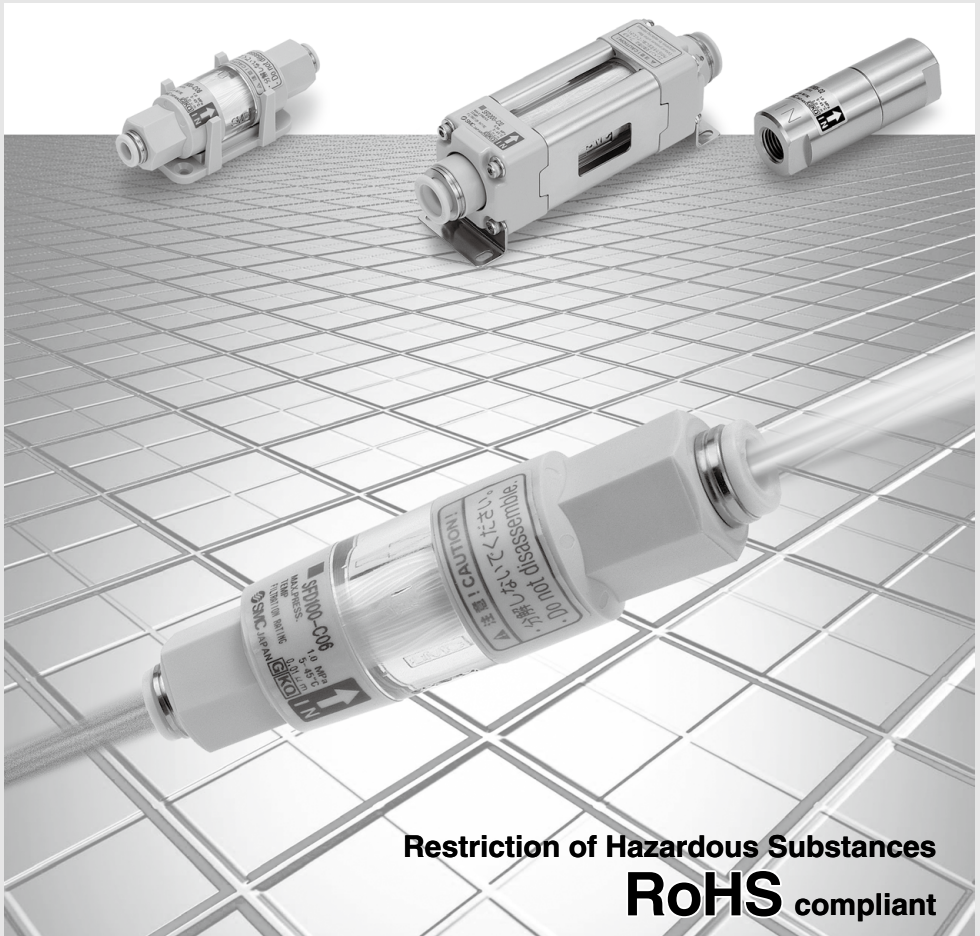

Restriction of Hazardous Substances
RoHS compliant

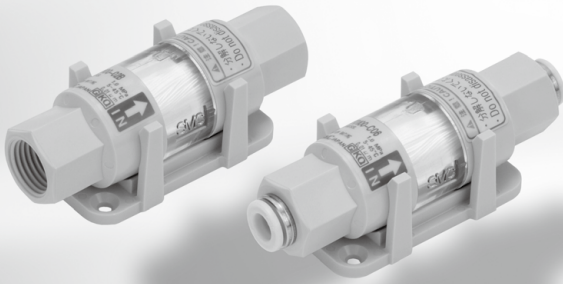

Clear resin case

- Easy to confirm a dirty element.
- Polycarbonated material is resistant to alcohol-based cleaning solutions.

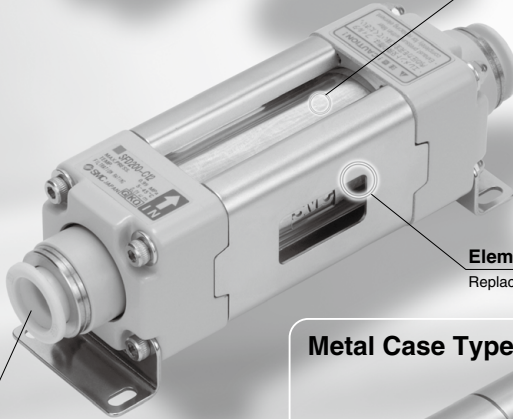

Element replaceable (Cartridge type)

Replaceable hollow fiber elements

Piping variation

- Clean One-touch fittings
- Female thread

Metal Case Type



Stainless steel or aluminum cases are available.

Metal case suitable for an atmosphere exposed to organic solvents and chemicals (Fluids: Air and (Nitrogen))

	SFD100, 110		SFD200		SFD101	SFD102
					Made to Order Pages 431 and 432	

Type	Disposable type (non-replaceable element)						Cartridge type (replaceable element)				
Flow rate L/min (ANR) (at inlet pressure 0.7 MPa)	SFD100	SFD110	SFD100	SFD110	SFD100	SFD110	Up to 300	Up to 400	Up to 500	Up to 100	
	Up to 60	Up to 70	Up to 80	Up to 100	Up to 100	Up to 120					
Port size	One-touch fitting	ø4	ø6	ø8			ø8	ø10	ø12	—	
	Female thread	—	—	Rc 1/4, G 1/4 NPT 1/4			—	—	Rc 1/4, G 1/4 NPT 1/4	Rc 1/4, G 1/4, NPT 1/4	
Case material	Resin						Resin			Aluminum	Stainless steel
Fluid	Air (Nitrogen)										
Nominal filtration rating	0.01 μm (filtration efficiency: 99.99%) <small>Note</small>										
Initial pressure drop	0.03 MPa (at inlet pressure 0.7 MPa, maximum flow)										
Maximum operating pressure (at 20°C)	1.0 MPa (in case of nitrogen: 0.99 MPa)										
Operating temperature	5 to 45°C										

Note The clean air filter is designed for the filtration of solid objects. It is not suitable for the separation of water and oil.

Integrated production in a clean environment

Under a clean environment, all components have undergone ultrasonic cleaning. Assembly, inspection and antistatic double packaging processes are conducted in an integrated production system.

Assembly environment

- Clean room : Class **M5.5** (ISO class **7**)^{*}
- Clean bench : Class **M3.5** (ISO class **5**)^{*}

^{*} Fed. Std. 209E () : based on ISO14644-1.

Application Examples

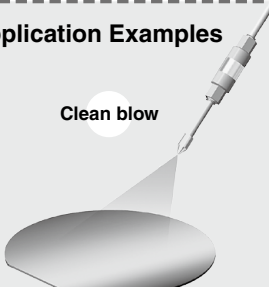

Clean blow

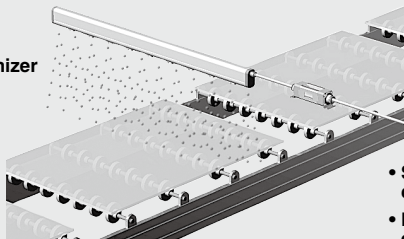

Blow of ionizer

- **Substitution of chamber**
- **Fluid pumping, etc.**

^{*} When blowing, take care not to entrain ambient air which could contaminate the workpieces.

Circuit Examples

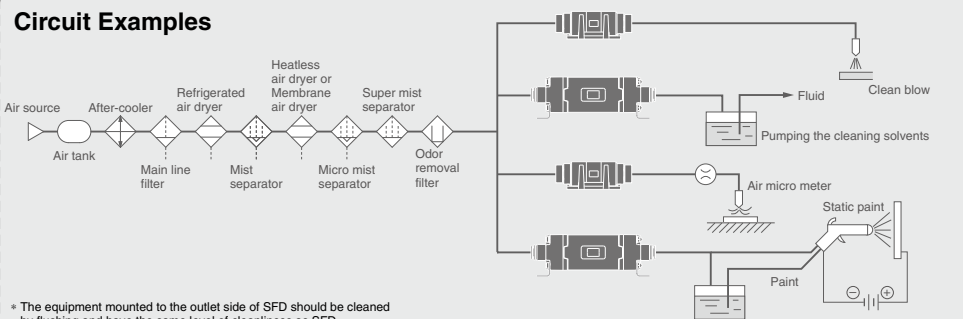

^{*} The equipment mounted to the outlet side of SFD should be cleaned by flushing and have the same level of cleanliness as SFD.

Hollow fiber membrane

The hollow fiber membrane has a porous construction with numerous fine holes on a straw type fiber membrane wall. The hollow fiber membrane filter traps and filtrates the impurities from the compressed air through the overlapping layered fine holes.



(Image)



(Image)

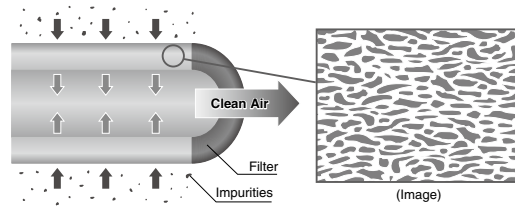

(Image)

SFD Series Model Selection

Select the model by using the following procedures involving the inlet pressure and the maximum flow rate.

[Example] Inlet pressure: 0.6 MPa

Maximum flow rate: 100 L/min (ANR)

1. Obtain the intersection A for the inlet pressure and the maximum flow rate by using the maximum flow rate chart.

2. If the obtained intersection A is above the maximum flow rate line, the SFD110-C08, -□02, SFD200-C12, -□02, -C10, or -C08 are selected.

Maximum Flow Rate

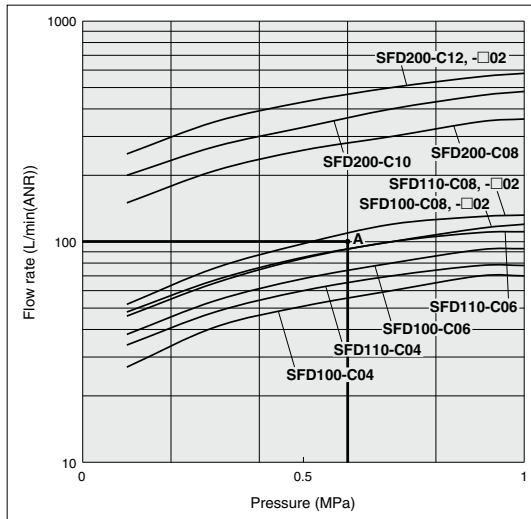

Clean Air Filter

SFD Series

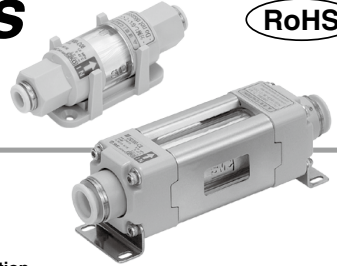

How to Order

SFD 10 0 - C08

Clean air filter

Size

Symbol	Max. flow rate
10	100 L/min (ANR)
11	120 L/min (ANR)
20	500 L/min (ANR)

Case material

Symbol	Material
0	Resin
1	Aluminum
2	Stainless steel

Symbol 1 and 2 are made to order. For details, refer to page 431.

Option

Symbol	Option
Nil	None
B	Bracket (SFD100 and 110 only)

* The brackets are provided with the SFD200 series as a standard product. (Nil)

Port size

Symbol	Connection size	Applicable size	
		SFD100, 110	SFD200
C04	ø4	●	—
C06	ø6	●	—
C08	ø8	●	●
C10	ø10	—	●
C12	ø12	—	●
02	Rc 1/4	●	●
N02	NPT 1/4	●	●
F02	G 1/4	●	●

Made to Order Different diameters for IN and OUT ports are Made to Order. For details, refer to page 432.

Relationship between Operating Temperature and Max. Operating Pressure

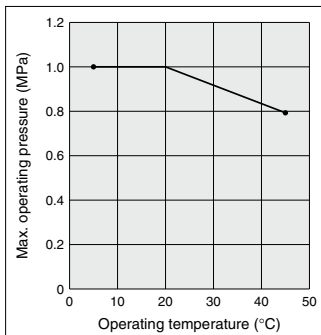

Specifications

Model	SFD10□	SFD11□	SFD20□
Port size	One-touch fittings ø4, ø6, ø8 Rc, NPT, G 1/4		One-touch fittings ø8, ø10, ø12 Rc, NPT, G 1/4
Fluid	Air (Nitrogen)		Air (Nitrogen)
Air flow capacity (at inlet pressure 0.7)	Up to 100 L/min (ANR)	Up to 120 L/min (ANR)	Up to 500 L/min (ANR)
Nominal filtration rating ^{Note 1)}	0.01 μm (99.99%)		
Operating pressure range ^{Note 2)}	- 100 kPa to 1.0 MPa (in case of nitrogen: 0.99 MPa)		
Operating temperature	5 to 45°C		
Initial pressure drop	0.03 MPa (at inlet pressure 0.7 MPa, maximum flow)		
Element proof differential pressure ^{Note 3)}	0.5 MPa		
Proof pressure	1.5 MPa		
Element service life	1 year, or when the pressure drop reaches 0.1 MPa.		

Note 1) Measured under SMC's specified conditions.

Note 2) The maximum operating pressure varies depending on temperature. Refer to the graph that shows the relationship between operating temperature and maximum operating pressure on the left.

Note 3) This means that the element does not break at 0.5 MPa. See "Specific Product Precautions".

Model	Port size	Rated flow (L/min (ANR)) ^{Note 1)}	Weight
SFD100	ø4 (One-touch fittings)	60	35 g
	ø6 (One-touch fittings)	80	35 g
	ø8 (One-touch fittings)	100	35 g
	Rc, NPT, G 1/4	100	35 g
	Rc, NPT, G 1/4	100	60 g
SFD101 ^{Note 2)}	Rc, NPT, G 1/4	100	150 g
SFD102 ^{Note 2)}	Rc, NPT, G 1/4	100	150 g
SFD110	ø4 (One-touch fittings)	70	35 g
	ø6 (One-touch fittings)	100	35 g
	ø8 (One-touch fittings)	120	35 g
	Rc, NPT, G 1/4	120	35 g
	ø8 (One-touch fittings)	300	190 g
SFD200	ø10 (One-touch fittings)	400	190 g
	ø12 (One-touch fittings)	500	190 g
	Rc, NPT, G 1/4	500	260 g

Note 1) The maximum flow rate when the inlet pressure is 0.7 MPa.

Note 2) SFD101 and SFD102 are produced upon receipt of order.



SFD Series

Flow Rate Characteristics

SFD100-C04

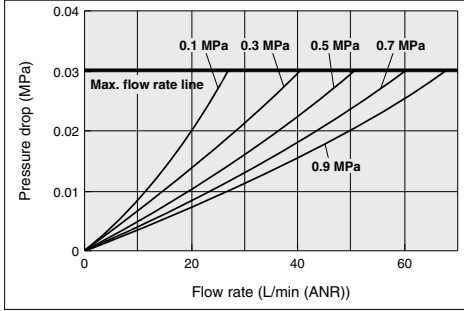

SFD110-C04

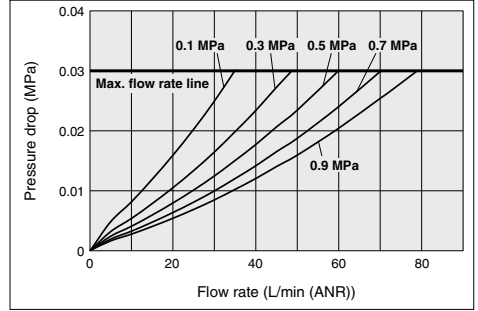

SFD100-C06

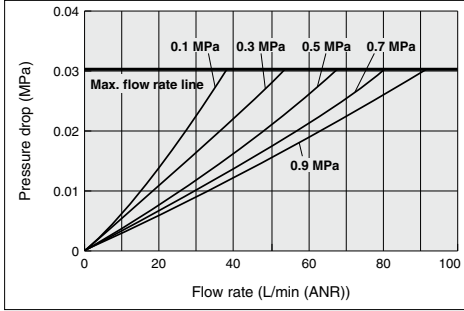

SFD110-C06

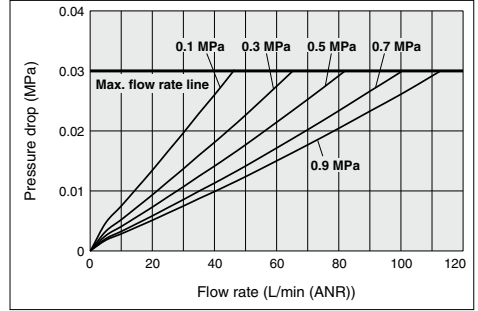

SFD100-C08, -02, -N02, -F02

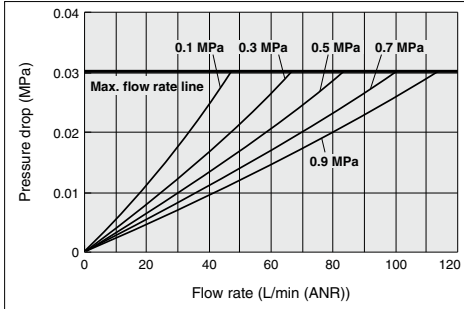

SFD110-C08, -02, -N02, -F02

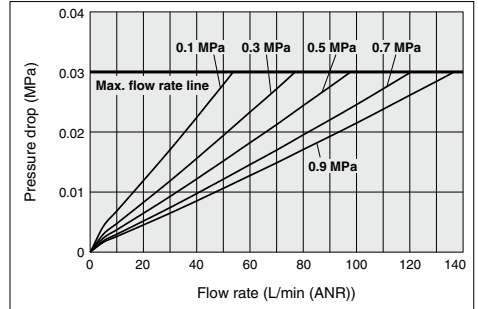

Flow Rate Characteristics

SFD200-C08

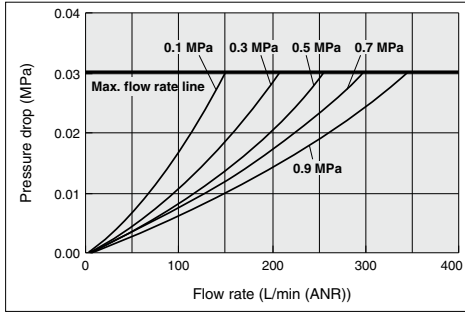

SFD200-C10

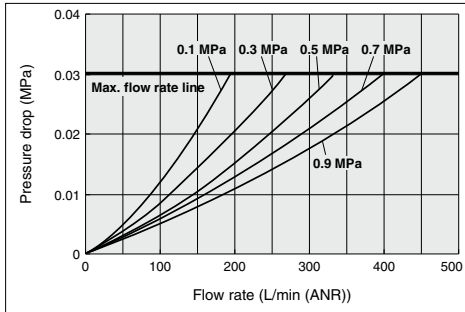

SFD200-C12, -02, -N02, -F02

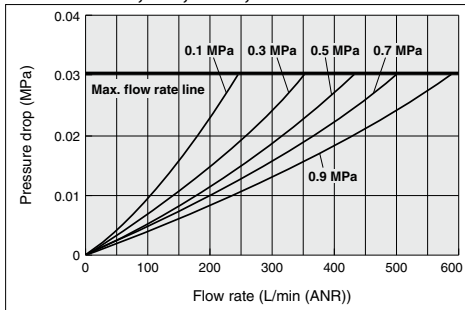

Construction

SFD100-C□

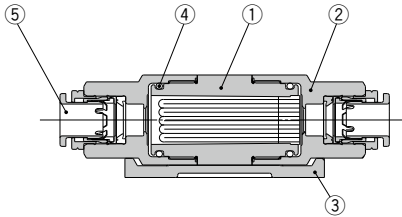

SFD100-□02

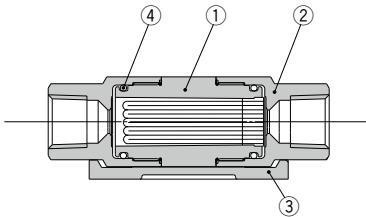

SFD110-C□

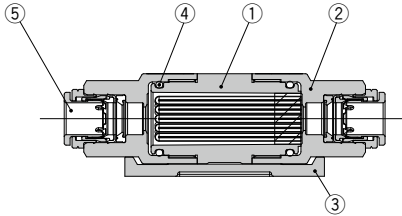

SFD110-□02

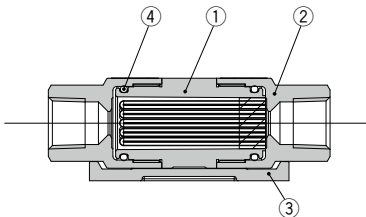

Component Parts

No.	Description	Material	Note
1	Element	PC, Polyolefin, PU, PET, ABS	
2	Cover	PBT	
3	Bracket	PBT	
4	O-ring	H-NBR	
5	Cassette	PP, EPDM, Stainless steel	

Replacement Parts

No.	Description	Material	Note
1	Bracket set	SFD-BR100	With 2 countersunk head screws (M3)

Component Parts

No.	Description	Material	Note
1	Element	PC, Polyolefin, PU, PET, ABS	
2	Cover	PBT	
3	Bracket	PBT	
4	O-ring	H-NBR	

Replacement Parts

No.	Description	Material	Note
1	Bracket set	SFD-BR100	With 2 countersunk head screws (M3)

Component Parts

No.	Description	Material	Note
1	Element	PC, Polyolefin, PU	
2	Cover	PBT	
3	Bracket	PBT	
4	O-ring	H-NBR	
5	Cassette	PP, EPDM, Stainless steel	

Replacement Parts

No.	Description	Material	Note
1	Bracket set	SFD-BR100	With 2 countersunk head screws (M3)

Component Parts

No.	Description	Material	Note
1	Element	PC, Polyolefin, PU	
2	Cover	PBT	
3	Bracket	PBT	
4	O-ring	H-NBR	

Replacement Parts

No.	Description	Material	Note
1	Bracket set	SFD-BR100	With 2 countersunk head screws (M3)

SFD Series

Construction

SFD200-C□

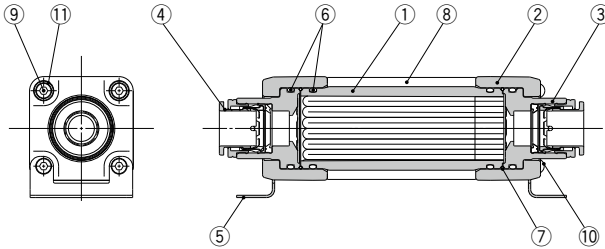

Component Parts

No.	Description	Material	Note
1	Element	PC, Polyolefin, PU	
2	Cover	Aluminum alloy	
3	Fitting body	PBT	
4	Cassette	PP, EPDM, Stainless steel	
5	Bracket	Stainless steel alloy	
6	O-ring A	H-NBR	
7	O-ring B	H-NBR	
8	Rod cover	Stainless steel alloy	
9	Tie-rod	Stainless steel alloy	
10	Cap nut	Stainless steel alloy	
11	Plain washer	Stainless steel alloy	

Replacement Parts

No.	Description	Material	Note
1	Element set	SFD-EL200	With 3 O-rings

SFD200-□02

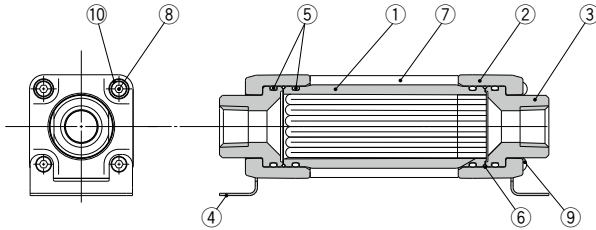

Component Parts

No.	Description	Material	Note
1	Element	PC, Polyolefin, PU	
2	Cover	Aluminum alloy	
3	Fitting body	Stainless steel alloy	
4	Bracket	Stainless steel alloy	
5	O-ring A	H-NBR	
6	O-ring B	H-NBR	
7	Rod cover	Stainless steel alloy	
8	Tie-rod	Stainless steel alloy	
9	Cap nut	Stainless steel alloy	
10	Plain washer	Stainless steel alloy	

Replacement Parts

No.	Description	Material	Note
1	Element set	SFD-EL200	With 3 O-rings

SFD Series

Dimensions

SFD100-C□/SFD110-C□

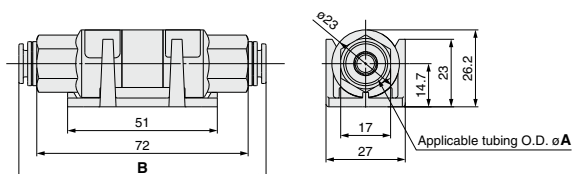

SFD100-C□ Dimensions

Model	A	B
SFD100-	C04	81
	C06	81
	C08	82

Bracket mounting dimensions

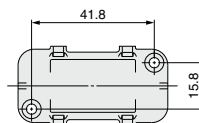

SFD100-□02/SFD110-□02

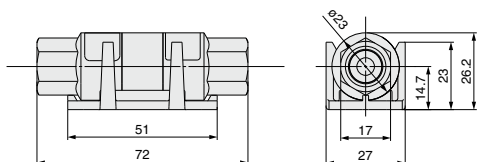

Hole shape for bracket mounting

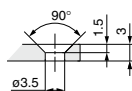

* Use a countersunk head screw (M3) for bracket mounting.

* Including the bracket mounting dimensions, the SFD100 and SFD110 have the same dimensions.

SFD200-C□

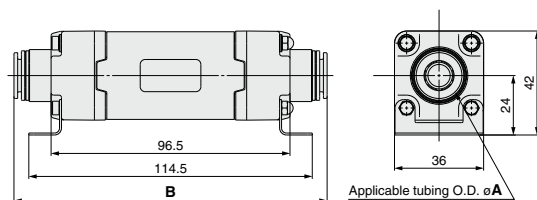

SFD200-C□ Dimensions

Model	A	B
SFD200-	C08	125
	C10	126
	C12	126

Bracket mounting dimensions

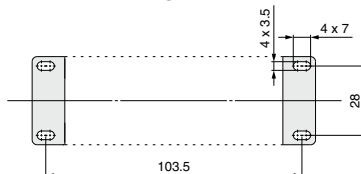

SFD200-□02

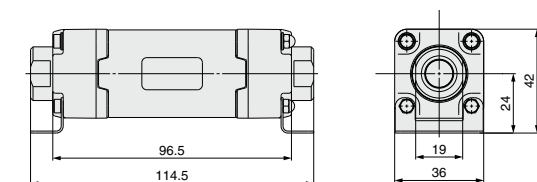

SFD Series

Made to Order Specifications 1

Please contact SMC for detailed specifications, delivery and prices.



1 Metal Case

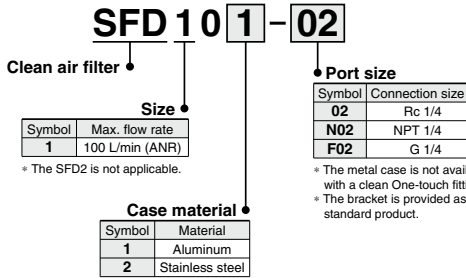

Metal case suitable for an atmosphere exposed to organic solvents and chemicals



Specifications

The specifications are the same as the standard product. Refer to "Specifications" on page 427.

Flow Rate Characteristics

The flow rate characteristics are the same as the SFD100-02. Refer to "Flow Rate Characteristics" on page 428.

Construction

SFD101-02

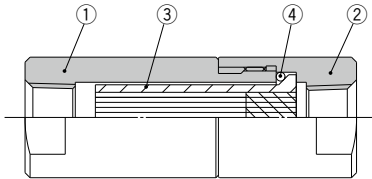

SFD102-02

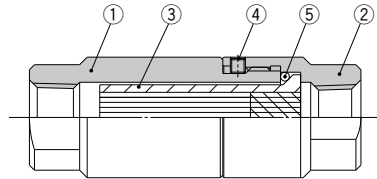

Component Parts

No.	Description	Material	Note
1	Case	Aluminum alloy	
2	Cover	Aluminum alloy	
3	Element	PC, Polyolefin, PU, PET, ABS	
4	O-ring	FKM	

Component Parts

No.	Description	Material	Note
1	Case	Stainless steel alloy	
2	Cover	Stainless steel alloy	
3	Element	PC, Polyolefin, PU, PET, ABS	
4	Hex. socket head set screw	Stainless steel alloy	
5	O-ring	FKM	

Replacement Parts

No.	Description	Part no.	Note
1	Element set	SFD-EL101	With O-ring
2	Bracket	SFD-BR101	Material: Stainless steel 304

Replacement Parts

No.	Description	Part no.	Note
1	Element set	SFD-EL101	With O-ring
2	Bracket	SFD-BR101	Material: Stainless steel 304

Dimensions

SFD101-02

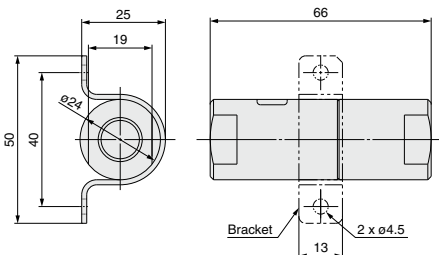

SFD102-02

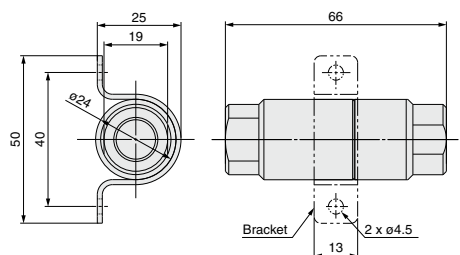

SFD Series

Made to Order Specifications 2

Please contact SMC for detailed specifications, delivery and prices.



2 Different Diameters for IN and OUT Ports

SFD 1 00 - C04 C06

Clean air filter

Size

Symbol	Max. flow rate
1	100 L/min (ANR)
2	500 L/min (ANR)

Case material

Symbol	Material
0	Resin

Option

Symbol	Option
Nil	None
B	Bracket (SFD100 only)

* The brackets are provided with the SFD200 series as a standard product. (Nil)

IN side connection symbol

IN side connection symbol	Connection size
C04	ø4
C06	ø6
C08	ø8
C10	ø10
C12	ø12
02	Rc 1/4
N02	NPT 1/4
F02	G 1/4

Clean One-touch fittings (KP series)

OUT side connection symbol

OUT side connection symbol	Connection size
C04	ø4
C06	ø6
C08	ø8
C10	ø10
C12	ø12
02	Rc 1/4
N02	NPT 1/4
F02	G 1/4

Clean One-touch fittings (KP series)

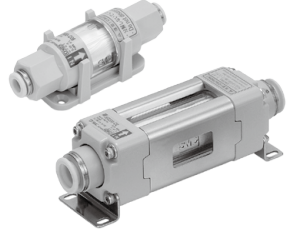

Specifications

The specifications are the same as the standard models. Refer to "Specifications" on page 427.

Flow Rate Characteristics

When the IN and OUT ports have different diameters, the flow rate characteristics will be those of the port with the smaller diameter. Refer to "Flow Rate Characteristics" for the smaller diameter from the chart of standard product on page 428.

Construction

The construction and materials are the same as the standard product. Refer to "Construction" on page 429.

SFD100 Different Diameter Combinations

IN port size	OUT port size					
	C04	C06	C08	02	N02	F02
C04	●	●	—	●	●	●
C06	●	●	—	●	●	●
C08	—	●	●	●	●	●
02	●	●	—	—	—	—
N02	●	●	—	—	—	—
F02	●	●	—	—	—	—

* The symbol "—" stands for unavailable combination.

SFD200 Different Diameter Combinations

IN port size	OUT port size					
	C08	C10	C12	02	N02	F02
C08	●	●	—	●	●	●
C10	●	●	—	●	●	●
C12	—	●	●	●	●	●
02	●	●	—	—	—	—
N02	●	●	—	—	—	—
F02	●	●	—	—	—	—

* The symbol "—" stands for unavailable combination.

Dimensions

SFD100 different diameters

One-touch fitting dimensions(A, B)

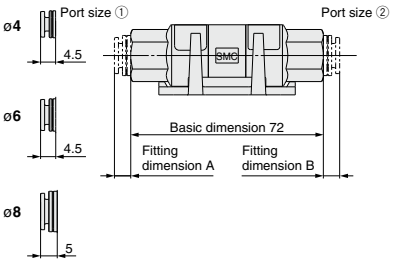

Model	Port size ①	Port size ②	Total length
SFD100-	C04 (C06)	C06 (C04)	81 (A + 72 + B)
	C04 (□02)	□02 (C04)	76.5 (72 + A)
	C06 (C08)	C08 (C06)	81.5 (A + 72 + B)
	C06 (□02)	□02 (C06)	76.5 (72 + A)
	C08 (□02)	□02 (C08)	77 (72 + A)

SFD200 different diameters

One-touch fitting dimensions(A, B)

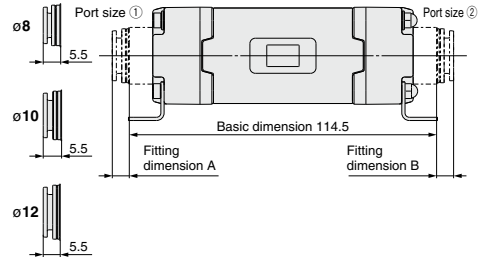

Model	Port size ①	Port size ②	Total length
SFD200-	C08 (C10)	C10 (C08)	125.5 (A + 114.5 + B)
	C08 (□02)	□02 (C08)	120 (114.5 + A)
	C10 (C12)	C12 (C10)	125.5 (A + 114.5 + B)
	C10 (□02)	□02 (C10)	120 (114.5 + A)
	C12 (□02)	□02 (C12)	120 (114.5 + A)

Related Products

<Pre-filters for SFD Series>

Mist Separator **AM Series**

Refer to pages 329 to 336 for details.



AM Series

Model	AM150C	AM250C
Rated flow (L/min (ANR))	300	750
Port size (Nominal size B)	1/8, 1/4	1/4, 3/8

Specifications

Fluid	Compressed air
Max. operating pressure	1.0 MPa
Min. operating pressure ^{Note)}	0.05 MPa
Proof pressure	1.5 MPa
Ambient temperature	5 to 60°C
Nominal filtration rating	0.3 μm (Filtering efficiency 99.9%)

Note) With auto drain: 0.1 MPa (N.O. type), 0.15 MPa (N.C. type)

Micro Mist Separator **AMD Series**

Refer to pages 337 to 345 for details.



AMD Series

Model	AMD150C	AMD250C
Rated flow (L/min (ANR))	200	500
Port size (Nominal size B)	1/8, 1/4	1/4, 3/8

Specifications

Fluid	Compressed air
Max. operating pressure	1.0 MPa
Min. operating pressure ^{Note)}	0.05 MPa
Proof pressure	1.5 MPa
Ambient temperature	5 to 60°C
Nominal filtration rating	0.01 μm (Filtering efficiency 99.9%)

Note) With auto drain: 0.1 MPa (N.O. type), 0.15 MPa (N.C. type)

Super Mist Separator **AME Series**

Refer to pages 355 to 362 for details.



AME Series

Model	AME150C	AME250C
Rated flow (L/min (ANR))	200	500
Port size (Nominal size B)	1/8, 1/4	1/4, 3/8

Specifications

Fluid	Compressed air
Max. operating pressure	1.0 MPa
Min. operating pressure	0.05 MPa
Proof pressure	1.5 MPa
Ambient temperature	5 to 60°C
Nominal filtration rating	0.01 μm (Filtering efficiency 99.9%)

Odor Removal Filter **AMF Series**

Refer to pages 363 to 370 for details.



AMF Series

Model	AMF150C	AMF250C
Rated flow (L/min (ANR))	200	500
Port size (Nominal size B)	1/8, 1/4	1/4, 3/8

Specifications

Fluid	Compressed air
Max. operating pressure	1.0 MPa
Min. operating pressure	0.05 MPa
Proof pressure	1.5 MPa
Ambient temperature	5 to 60°C
Nominal filtration rating	0.01 μm (Filtering efficiency 99.9%)



SFD Series

Specific Product Precautions 1

Be sure to read this before handling the products. Refer to page 9 for safety instructions and pages 10 to 12 for air preparation equipment precautions.

Selection

Warning

1. Thoroughly and carefully confirm the purpose of use, required specifications and operating conditions (fluid, pressure, flow rate, nominal filtration rating and environment) then select a model within the specifications.
2. The product is not certified under the High Pressure Gas Safety law, so for nitrogen, its maximum operating pressure will be 0.99 MPa (gauge pressure).
3. Contact us beforehand if the product will be used in an application such as a caisson shield, breathing, food and/or medical treatment that affects the human body directly or indirectly.
4. If the compressed air includes ozone, do not use it since it may damage the product or cause malfunction. When it includes ozone, use a clean gas filter (SFA/B/C).

Mounting

Warning

1. **Operation manual**
Mount the product after reading and understanding the operation manual. Keep it in a location where it can easily be found.
2. **Flushing**
Flush the piping line when the filter is used for the first time or has been replaced. In the event of connecting such as piping, flush (air blow) when using this product for the first time or replacing its elements in order to reduce the affect of the dust generated from the connection, etc. Flushing the line is also required to eliminate contamination resulting from the piping line installation. Therefore, be sure to flush the line before actually running the system. Fix all mounting parts for use.
3. **Use fittings with resin threads for the connection of fittings to the IN and OUT ports.**
Using fittings with metal threads could damage the IN and OUT ports (SFD100 only).
4. **Connect tubing to the IN and OUT One-touch fittings in accordance with the precautions for One-touch fittings.**

Caution

1. **Connect the piping in accordance with the flow direction marked on the case.**
If connected in reverse, the element could break.
2. **The mounting orientation does not affect the performance, but if excessive force is applied to the SFD100 series, the body may become disconnected from the bracket.**
Therefore, take particular care about the mounting orientation.

Caution on Installation

Warning

1. **The material of the element is polycarbonate.**
The material is resistant to wiping with alcohol, but is not suitable for atmospheres or places with organic solvents, chemicals, cutting oils, synthetic oils, ester base compressor oils, alkalis or thread locking agents.

Caution

1. **If the pressure difference (pressure drop) between the inlet and the outlet exceeds 0.1 MPa, it can cause damage to the product.**
2. **Do not install the product in a place where it can be affected by a pulsation (including surge pressure) of over 0.1 MPa.**
3. **Use caution regarding the particles that may be emitted from the outlet side of a pneumatic equipment.**

Installation of a pneumatic equipment on the outlet side can deteriorate the cleanliness because a particle will be generated from the equipment.
The mounting position of the pneumatic equipment needs to be considered.

4. **Set the air flow capacity with an initial pressure drop of 0.03 MPa or less. If the initial pressure drop is set to be high, its service life will be shorten due to clogging.**
5. **Determine the product by the maximum consumption flow rate.**

When using compressed air for an air blow application, calculate the maximum volume of air that will be consumed before selecting the SFD series product size.

6. **Generally, the following pollutant particles are contained in compressed air.**

[Pollutant particle substances contained in the compressed air]

- Moisture (drainage)
 - Dusts and particles which are in the surrounding air
 - Deteriorated oil which is discharged from the compressor
 - Solid foreign matter such as rust and/or oil in the piping
- 1) The SFD series is not compatible with compressed air which contains fluids such as water and/or oil.
 - 2) Install a dryer (IDF, IDG, ID series), mist separator (AM series), micro mist separator (AMD series), super mist separator (AME series), or odor removal filter (AMF series), etc., for the source of the air for the SFD series.

7. **Using with a flow-rate much higher than its specification could lead to exceeding the differential pressure the product can resist.**

Use the product within its specifications. Also, take care about the replacement period of the product, taking into consideration that the differential pressure of the filter will increase over time.



SFD Series Specific Product Precautions 2

Be sure to read this before handling the products. Refer to page 9 for safety instructions and pages 10 to 12 for air preparation equipment precautions.

Piping

⚠ Caution

1. Unpacking the sealed package

Since the filter is sealed in an antistatic double bag, the inner package should be unpacked in a clean atmosphere (such as a clean room).

2. Apply a wrench to 2 chamfered flats or hexagon portion on the IN side or the OUT side to prevent the housing from rotating.

3. Always tighten threads with the proper tightening torque.

When attaching fittings to the product, tighten with the proper tightening torque shown below.

Material	Tightening torque (N·m)
Resin	2 to 3
Metal	12 to 14

4. Check the arrow mark on the case which shows the flow direction to connect the IN and OUT ports correctly.

If connected in reverse, the element could break.

Maintenance

⚠ Warning

1. Follow the maintenance procedures in the operation manual. If handled incorrectly equipment or device can be damaged or cause a malfunction.

2. When removing the product, exhaust the air and ensure the air is released to atmosphere before removing it.

3. When the element comes to the end of its life, immediately replace it with a new filter or replacement element.

Service life of element

The service life of the element ends when either of the following two conditions occurs.

- 1) After 1 year of usage has elapsed.
- 2) When the pressure drop reaches 0.1 MPa even though the operating period has been less than 1 year.

Operating Environment

⚠ Warning

1. Do not operate under the conditions listed below due to a risk of malfunction.

In locations having corrosive gases, organic solvents, and chemical solutions, or in locations in which these elements are likely to adhere to the equipment.

In locations in which salt water, water, or water vapor could come in contact with the equipment.

In locations that are exposed to direct sunlight. (Shield the equipment from sunlight to prevent its resin material from ultraviolet ray degradation or overheating.)

In locations that have a heat source and poor ventilation. (Shield the equipment from heat sources to protect it from softening degradation due to radiated heat.)

In locations that are exposed to shocks and vibrations.

In locations with high humidity or a large amounts of dust.

2. When the product is used for blowing, use caution to prevent the work from being damaged by entrained air from the surrounding area.

When the compressed air is used for air blow, the exhausted air from the blow nozzle may have taken in airborne foreign matter (such as solid particle, fluid particle) from the surround air. The foreign matter will be sprayed on the work, and the airborne foreign matter may adhere to it. Therefore, use caution for the surrounding environment.

Other Tube Brands

⚠ Caution

1. When tubing of brands other than SMC's are used, verify that the tubing O.D. satisfies the following accuracy;

- 1) Polyolefin tube: Within ± 0.1 mm
- 2) Polyurethane tubing: Within $+0.15$ mm, within -0.2 mm
- 3) Nylon tubing: Within ± 0.1 mm
- 4) Soft nylon tubing: Within ± 0.1 mm

Do not use tubing which does not meet these outside diameter tolerances. It may not be possible to connect them, or they may cause other trouble, such as air leakage or the tube pulling out after connection.

The recommended tube for the clean fitting is polyolefin tube. Other tubes can satisfy the performance in terms of leakage, tensile strength, etc., but impair the cleanliness. Note this point for use.