

# Clean Design Manifold Valve

## JSY5000-H Series



**IP69K**

# Low fluid accumulation

# Easy to clean

**Large flow rate**

**1,600**<sup>\*1</sup> L/min (ANR)

**Enclosure: IP69K**

**NSF-H1 grease**

**External parts: FDA-compliant materials**<sup>\*2</sup>

Metal parts are made of stainless steel 316 with high anti-corrosion performance.

**Wiring: Lead wire/  
Fieldbus type**  
**IO-Link**

\*1 When the inlet side is 0.6 MPa, and the outlet side is 0.5 MPa (20°C)  
 \*2 The lead wire type cable is not made of FDA-compliant materials.

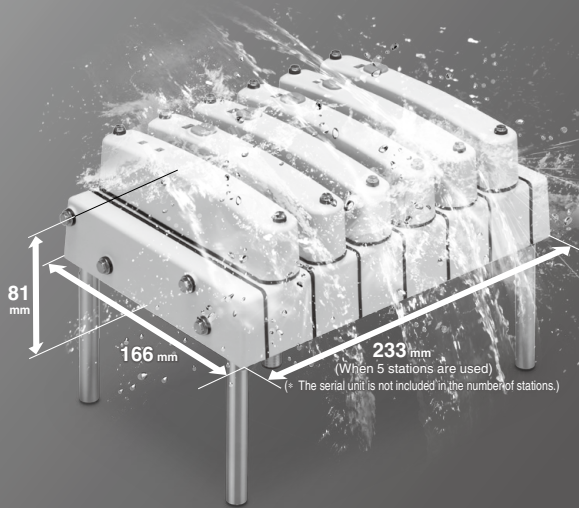

The photo shows the IO-Link compatible manifold.

**Crevice free exterior and can be  
cleaned without disassembly**  
**Cleanable space between valves**



**Valve width is 15 mm.**

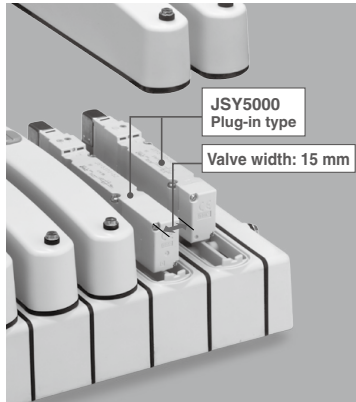

**Sub-plate (Single unit)**

**IP69K compliant**



## Wiring

### Manifold valve

#### Lead wire type



#### Fieldbus type

IO-Link M12 connector SI unit EX430 p. 255

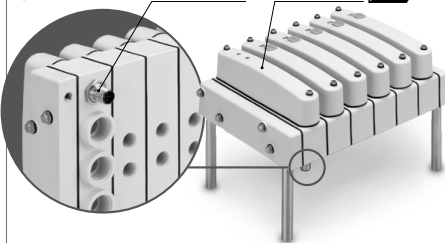

### Sub-plate (Single unit)

#### M12 connector cable



## Manifold Parts

### Mounting leg

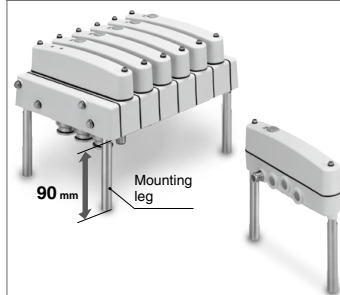

### With One-touch fittings





### 5-port type

#### Manifold block assembly p. 250

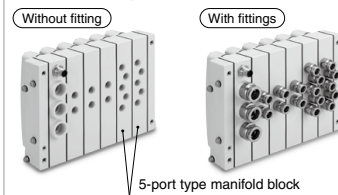
When the same manifold is used for different pressures, a manifold block assembly is used as a supply port for different pressures. It is also used for independent exhaust.  
\* Use with blocking disks.



## Series Variations

Variations	4(A), 2(B) port size								Rated voltage	Wiring		
	G1/4 (Without fitting)	One-touch fitting								Common specifications		
		Screw fitting								Positive common	Negative common	
		ø8		ø10		ø5/16"		ø3/8"				
Brass	Stainless steel	Brass	Stainless steel	Brass	Stainless steel	Brass	Stainless steel					
Plug-in Lead wire type (34 cores) p. 234 	●	●	●	●	●	●	●	●	●	●		
Plug-in Fieldbus type IO-Link p. 234 	●	●	●	●	●	●	●	●	—	●		
Sub-plate type p. 242 	●	●	●	●	●	●	●	●	●	●		

● Standard ○ Option ▲ Made to order

## Manifold Options

### ■ Blanking plate [With two mounting screws] p. 257

Used when valve additions are expected or for maintenance

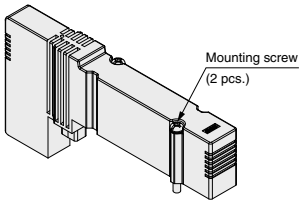

JSY51M-26P-1A

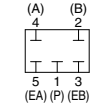

Circuit diagram

### ■ SUP/EXH blocking disk p. 257

#### [SUP blocking disk]

By inserting the SUP blocking disk in the pressure supply passage of the manifold valve, can provide two different high and low pressure in one manifold.

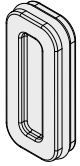

#### [EXH blocking disk]

By inserting the EXH blocking disk in the exhaust passage of the manifold valve, can separate the exhaust from the valve so it does not affect the other valves. It can also be used for the manifold for the positive pressure and vacuum mixed manifold. (2 pieces are required to block EA/EB both sides of the EXH.)

Series	SUP blocking disk	EXH blocking disk
JSY5000	JSY51M-40P-2A	JSY51M-40P-2A

### ■ Tube releasing tool p. 256

This tool is used for removing the tube from port A and B.

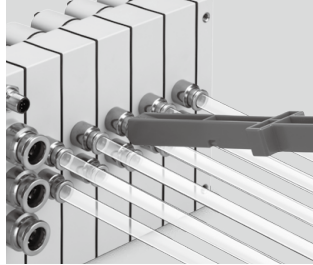
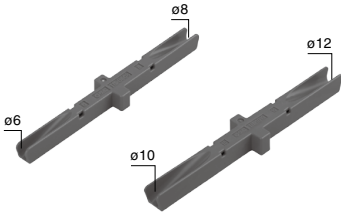

## Applications

Installed inside equipment

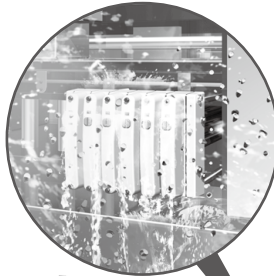

Installed near actuators

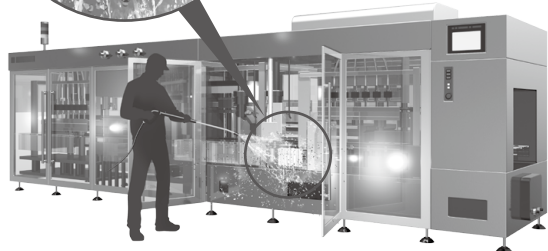
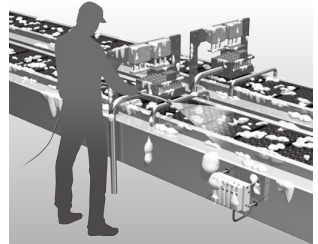

	Manifold options		Valve options	
	Blanking plate	SUP/EXH blocking disk	Vacuum/ Low pressure specification	Reverse pressure
	○ p. 257	○ p. 257	▲ External pilot	▲ External pilot
	○ p. 257	○ p. 257	▲ External pilot	▲ External pilot
	—	—	▲ External pilot	▲ External pilot

## IP69K manifold

IP69K products are IP6X (IEC/EN 60529) and IPX9K (ISO 20653) compliant and protected against dust and high-pressure hot water.

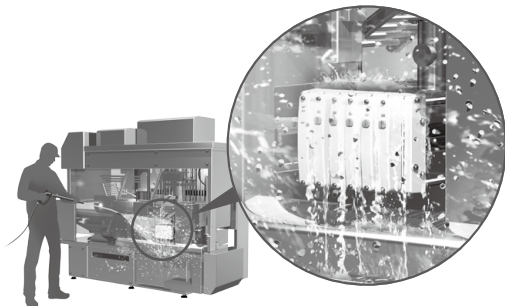

### Glossary of Terms

**IP6X:** Dust-tight

**IPX9K:** High-pressure and temperature jet wash

Not adversely affected under the following conditions.

Sample placed on a turntable and rotated at a speed of  $5 \pm 1$  rpm. Hot pressurized water at  $80 \pm 5^\circ\text{C}$  and pressure 8 to 10 MPa is then sprayed onto the sample at a distance of 100 to 150 mm with a jetwash nozzle from four position:  $0^\circ$ ,  $30^\circ$ ,  $60^\circ$ , and  $90^\circ$ , for 30 s for each position. Flow rate:  $15 \pm 1$  L/min

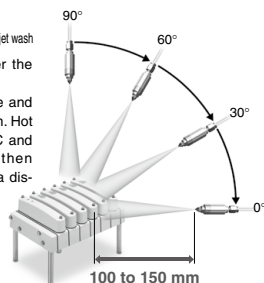

## Related Products

### EHEDG Compliant Fittings

EHEDG Compliant

IP69K

Hygienic Design

FDA Compliant



#### KFG2H□-E Series

\* This product is not assembled when shipped.



### EHEDG Certification

This series satisfies EHEDG guidelines (hygienic design standards), preventing liquid and foreign matter from entering, and is easy to wash.

### Design for less residual liquid accumulation



#### EHEDG compliant fitting

Design for better liquid flow and less residual liquid accumulation

#### Existing KFG2 model

Design for poor liquid flow and more residual liquid accumulation

### Achieved IP69K rating

#### Rubber parts

The material used is a special FKM that is compliant with the FDA (U.S. Food and Drug Administration) §177.2600 dissolution test. They are colored in blue for superior visibility.

#### Body type: Male connector

#### Connection thread: M, G\*1

\*1 ISO 16030 compliant

#### Fluid temperature

-5 to  $150^\circ\text{C}$

### EHEDG design standards

- 1 External surface roughness: Ra  $0.8 \mu\text{m}$  or less
- 2 Corners of radius 3 mm or more with an internal angle of  $135^\circ$
- 3 Stainless material with high anti-corrosion performance: Stainless steel 316
- 4 No direct contact of external metal parts
- 5 Gasket seals made of FDA-compliant rubber materials



EHEDG Certificate of Compliance

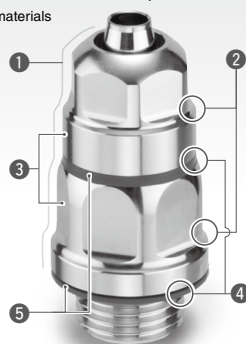



## Related Products

### Clean Design Fittings

\*1 This product is not assembled when shipped.



Hygienic Design

FDA Compliant

Stainless Steel 316 Insert Fittings  
**KFG2H□-C Series**

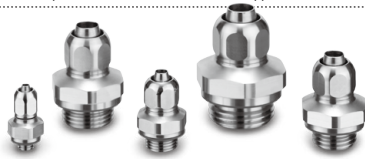

### FDA Compliant Fittings



FDA Compliant



Stainless Steel 316 One-touch Fittings  
**KQG2-F Series**



Metal One-touch Fittings  
**KQB2-F Series**

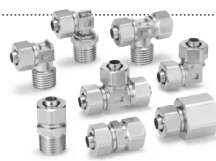

Stainless Steel 316 Insert Fittings  
**KFG2-F Series**

## FDA (U.S. Food and Drug Administration) Compliant Tubing

FDA Compliant

**Polyurethane Tubing**  
**TU-X214**



- Complies with the FDA (U.S. Food and Drug Administration) § 177.2600 dissolution test
- Complies with the EU No 10/2011 dissolution test

Metric size	Color
ø4, ø6, ø8, ø10, ø12	Black, White, Red, Blue, Yellow, Green, Clear, Orange

**Fluoropolymer Tubing**  
**TL/TIL**



- Complies with the FDA (U.S. Food and Drug Administration) § 177.1550 dissolution test
- Food Sanitation Law compliant\*<sup>1</sup>

Metric size	Inch size	Color
ø4, ø6, ø8, ø10, ø12, ø19	ø1/8", ø3/16", ø1/4", ø3/8", ø1/2", ø3/4", ø1"	Translucent

**Fluoropolymer Tubing (PFA)**  
**TLM/TILM**



- Complies with the FDA (U.S. Food and Drug Administration) § 177.1550 dissolution test
- Food Sanitation Law compliant\*<sup>1</sup>

Metric size	Inch size	Color
ø2, ø3, ø4, ø6, ø8, ø10, ø12, ø16, ø19, ø25	ø1/8", ø3/16", ø1/4", ø3/8", ø1/2", ø3/4", ø1", ø1 1/4"	Translucent, Black, Red, Blue

**FEP Tubing (Fluoropolymer)**  
**TH/THH**



- Complies with the FDA (U.S. Food and Drug Administration) § 177.1550 dissolution test
- Food Sanitation Law compliant\*<sup>1</sup>

Metric size	Inch size	Color
ø4, ø6, ø8, ø10, ø12	ø1/8", ø3/16", ø1/4", ø3/8", ø1/2", ø3/4"	Translucent, Black, Red, Blue

**Soft Fluoropolymer Tubing**  
**TD/TID**



- Complies with the FDA (U.S. Food and Drug Administration) § 177.1550 dissolution test
- Food Sanitation Law compliant\*<sup>1</sup>

Metric size	Inch size	Color
ø4, ø6, ø8, ø10, ø12	ø1/8", ø3/16", ø1/4", ø3/8", ø1/2"	Translucent

**Polyolefin Tubing**  
**TPH**



- Complies with the FDA (U.S. Food and Drug Administration) § 175.300 dissolution test

Metric size	Color
ø4, ø6, ø8, ø10, ø12	White, Blue, Yellow

**Soft Polyolefin Tubing**  
**TPS**



- Complies with the FDA (U.S. Food and Drug Administration) § 175.300 dissolution test

Metric size	Color
ø4, ø6, ø8, ø10, ø12	White, Blue, Yellow

\*1 Testing in compliance with Japan's Food Sanitation Law based on the 370th notice given by the Ministry of Health and Welfare in 1959

# CONTENTS

<b>Valve Specifications</b> .....	p. 229
Valve Specifications (JSY5000-H Plug-in Type) .....	p. 230
Manifold Specifications .....	p. 230
Manifold Flow Rate Characteristics/Weight .....	p. 230
Valve Weight .....	p. 230
Response Time .....	p. 230
Connector Wiring Layout .....	p. 230
<b>Valve Construction</b> .....	p. 231
<b>Valve Replacement Parts: Pilot Valve</b> .....	p. 232

Manifold

**Clean Design  
Manifold Valve**  
JSY5000-H Series [IP69K Compliant]



p. 234

How to Order Manifolds .....	p. 234
How to Order Valves .....	p. 235
Dimensions: Lead Wire Type .....	p. 236
Electrical Wiring Specifications .....	p. 237
Dimensions: Fieldbus Type (IO-Link) .....	p. 238
Dimensions: 5-Port Type Manifold Block (Common to Lead Wire Type/Fieldbus Type (IO-Link)) .....	p. 239
Dimensions: Panel Cutout Dimensions .....	p. 240
Dimensions: External Pilot (Made to Order) .....	p. 241

Sub-plate

**Sub-plate (Single Unit)**  
[IP69K Compliant]



p. 242

Sub-plate Specifications .....	p. 242
Sub-plate Flow Rate Characteristics/Weight .....	p. 242
How to Order Sub-plates (With Valve/Valve Cover) .....	p. 243
Dimensions: Sub-plate .....	p. 244

<b>Manifold Exploded View</b> .....	p. 246
Lead Wire Type .....	p. 246
Fieldbus Type .....	p. 247
Manifold Exploded View (Common Parts) .....	p. 248
Manifold Parts Nos. .....	p. 249

<b>Sub-plate (Single Unit) Exploded View</b> .....	p. 254
Sub-plate Parts Nos. .....	p. 254

<b>Fieldbus System: For Output EX430 Series</b> .....	p. 255
<b>One-touch Fittings, Plugs, Tube Releasing Tools</b> .....	p. 256
<b>Manifold Options</b> .....	p. 257
<b>Made to Order</b> .....	p. 258

<b>JSY5000-H Series: Specific Product Precautions</b> .....	p. 259
<b>EX430 Series: Specific Product Precautions</b> .....	p. 263

# JSY5000-H Series Valve Specifications

## Valve Specifications (JSY5000-H Plug-in Type)

Valve type		Rubber seal	
Fluid		Air	
Internal pilot operating pressure range MPa	2-position single		0.15 to 0.7
	2-position double		0.1 to 0.7
	3-position		0.2 to 0.7
	4-position dual 3-port valve		0.15 to 0.7
External pilot (Made to order) operating pressure range MPa	Operating pressure range		-100 kPa to 0.7
	Pilot pressure range	2-position single	0.25 to 0.7
		2-position double	
3-position			
Ambient and fluid temperatures*1 °C			-10 to 50 (No freezing)
Max. operating frequency Hz	JSY5000	2-position single/double	5
		4-position dual 3-port valve	3
		3-position	3
Manual override		Non-locking push type	
Pilot exhaust type	Internal pilot		Common exhaust
	External pilot (Made to order)		
Lubrication		Not required	
Mounting orientation*2		Unrestricted	
Impact/Vibration resistance*2 m/s <sup>2</sup>		150/30	
Coil rated voltage DC		24 V	
Allowable voltage fluctuation V		±10% of the rated voltage	
Power consumption W	Standard		0.4
	With power-saving circuit (Made to order)		0.1*3 [Inrush 0.4, Holding 0.1]
Surge voltage suppressor		Diode (Varistor for non-polar type)	
Indicator light		LED	

\*1 The product is IPX9K compliant (protected against high-pressure hot water). However, operation of the valve must be within the specified valve ambient temperature and fluid temperature range.

\*2 Impact resistance: The value at which no malfunction occurs when tested in the axial direction and at right angles to the main valve and the armature in both energized and de-energized states, once for each condition (Values from the initial stage)

Vibration resistance: The value at which no malfunction occurs in a one-sweep test between 45 and 2000 Hz, performed in both energized and de-energized states in the axial direction and at right angles to the main valve and the armature (Values from the initial stage)

\*3 For details, refer to page 260.

# JSY5000-H Series

## Manifold Specifications

Type		Lead wire	Fieldbus (IO-Link)*1
Manifold type		Plug-in connector connecting base	
SUP/EXH port type		Common SUP/EXH	
Valve stations		2 to 16 stations	
Internal wiring		Positive common Negative common (Refer to "Electrical Wiring Specifications" on page 237.)	Negative common
Port size	SUP/EXH block	1(P), 5(EA), 3(EB) port	G1/2 (Based on ISO 16030)
	2-port type manifold block	4(A), 2(B) port	G1/4 (Based on ISO 16030)
	5-port type manifold block	1(P), 4(A), 2(B), 5(EA), 3(EB) port	G1/4 (Based on ISO 16030)
Enclosure		IP69K (Based on IEC/EN 60529/ISO 20653)	
External parts material		Resin parts: PA, Metal parts: Stainless steel 316, Rubber parts: EPDM	

\*1 Refer to page 255 for the Fieldbus type for output (EX430 series) specifications.

## Manifold Flow Rate Characteristics

Manifold block type	Port size		Flow rate characteristics			
	1, 5, 3 (P, EA, EB)	4, 2 (A, B)	1 → 4, 2 (P → A, B)		4, 2 → 5, 3(A, B → EA, EB)	
			C [dm <sup>3</sup> /(s·bar)]	b	C [dm <sup>3</sup> /(s·bar)]	b
2-port type	G1/2	G1/4	6.80	0.31	7.64	0.23
5-port type	G1/4		5.60	0.21	5.67	0.22

\* The flow rate characteristics values are for an individually operated 2-position type manifold base with 5 stations.

## Manifold Weight

Manifold block type (2-port/5-port type)	Weight: g*1 (n: Number of stations)
Lead wire type	227 n + 1070
Fieldbus type	227 n + 500

\*1 Weight without fittings. For when a lead wire type cable is 5 m. Add the weight of the valves to be mounted from the table below to find the total weight.

## Valve Weight

Valve model	Type of actuation	Weight [g]	
JSY5□03-H	2-position	Single	86
		Double	96
	3-position	Closed center	106
		Exhaust center	
		Pressure center	
	4-position	Dual 3-port	92

## Response Time

Valve model	Response time [ms]*1	
	Z type	U type
JSY5103-H	40	32
JSY5203-H	19	19
JSY53/4/503-H	46	44
JSY5A/B/C03-H	38*2	29*2

\*1 Based on dynamic performance test, JIS B 8419:2010 (Coil temperature: 20°C, at rated voltage)

\*2 There will be an approx. 10 ms delay on the 2(B) port side due to the length of the pilot passage.

## Connector Wiring Layout

For both Fieldbus and lead wire types, additional valves are sequentially assigned pins on the connector. This makes it completely unnecessary to disassemble the connector unit.

■ Single solenoid valve is installed to all double wiring. (Double wiring specification) (Manifold specification sheet is not necessary.)

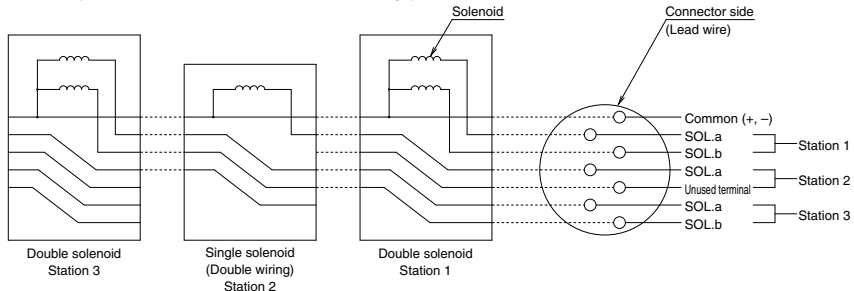

\* These diagrams are for the purpose of explanation, and differ from the actual connector wiring.

# JSY5000-H Series Valve Construction

## Rubber Seal

### 2-position single

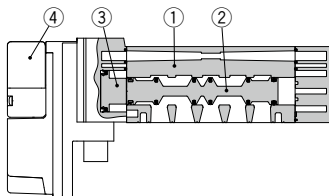

2-position single

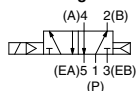

### 2-position double

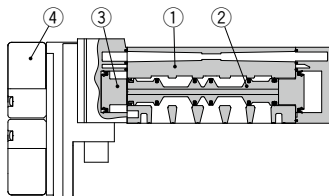

2-position double

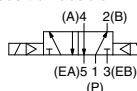

### 3-position closed center/exhaust center/pressure center

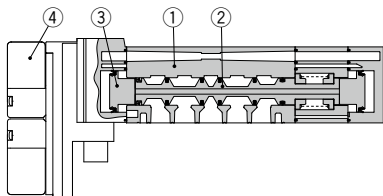

3-position closed center

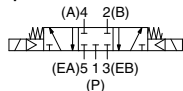

3-position exhaust center



3-position pressure center

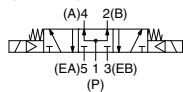

### 4-position dual 3-port

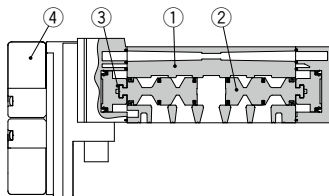

4-position dual 3-port  
N.C. x 2 pcs.

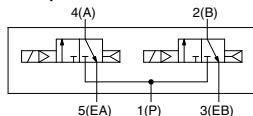

N.O. x 2 pcs.

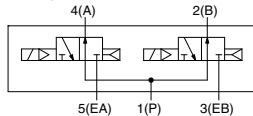

N.C./N.O. 1 pc. of each

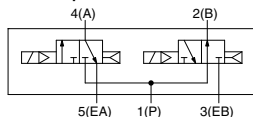

## Component Parts

No.	Description	Material
1	Body	Aluminum die-casted
2	Spool valve	Aluminum/HNBR (4-position dual 3-port: Resin/HNBR)
3	Piston	Resin
4	Pilot valve	—

## Valve Replacement Parts: Pilot Valve

### How to Order Pilot Valves (With a gasket and two mounting screws)

V112    - 5 A

**Coil type**

Nil	Standard
T	With power-saving circuit (Made to order)

**Rated voltage**

5	24 VDC
---	--------

#### ⚠ Caution

1. The coil specification and voltage (including light/surge voltage suppressor) cannot be changed by changing the pilot valve.
2. When selecting the standard coil type, it is not possible to change to the power-saving circuit type.

#### How to replace pilot valves

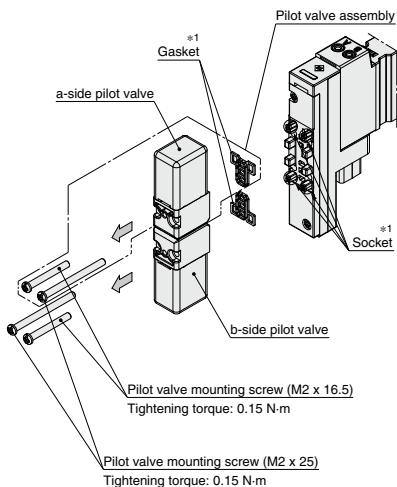

- Remove the pilot valve mounting screws.
- Remove the pilot valve in the direction indicated by the arrow.

\*1 Ensure the gasket is mounted, and take care not to bend the socket.

\* Assemble by following the removal procedure in reverse.





# Clean Design Manifold Valve

## JSY5000-H Series

[IP69K Compliant]

**Caution** This is an IP69K compliant product. The manifold and valves are ordered as a set.

### How to Order Manifolds

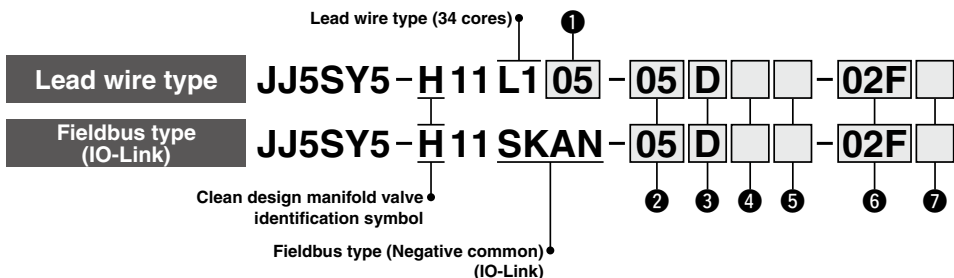

#### ① Lead wire length

Symbol	Length
05	5 m
10	10 m
15	15 m

#### ② Valve stations

Symbol	Stations	Note
02	2 stations	Double wiring*1
⋮	⋮	
16	16 stations	

\*1 Valve stations number includes stations with a blanking plate, and is the total number for all 2-port and 5-port type manifold blocks.

#### ③ SUP/EXH block 1(P), 5(EA), 3(EB) port entry

D	D side (2 to 10 stations)
B	Both sides (2 to 16 stations)

\* SUP/EXH blocks with U side only is not available.

#### ④ Pilot type

Symbol	Pilot type
Nil	Internal pilot
R*1	External pilot

\*1 External pilot port is on the D side end block.

The external pilot specification should be ordered as made to order.

#### ⑤ 5-port type manifold block stations

Symbol	Stations	Note
Nil	None	Specify the number of stations with 5-port type manifold blocks, so this will be equal to or less than the total number of valve stations.
01	1 station	
⋮	⋮	
16	16 stations	Specify the arrangement and blocking disk mounting position in the manifold specification sheet.

\* E.g.) When the symbol is "02", 2 stations are 5-port type manifold blocks.

When the symbol is Nil or blank, all stations are of 2-port type manifold block.

\* When different pressures are required, use 5-port type manifold blocks with blocking disks. Use of 5-port type manifold blocks without blocking disks can be used to provide an intermediate SUP/EXH block function.

#### ⑥ Manifold block port size

[Thread piping/One-touch fitting (Metric/Inch size)]

Symbol	Fitting specifications		Manifold block port size		Note		
			2-port type	5-port type	SUP/EXH block		D side end block
					P, EA, EB port	X, PE*2 port	VENT port
02F	Without fitting		G1/4 Thread piping	G1/2 Thread piping	G1/8 Thread piping	M5 Thread piping	
B8	Metric size Threaded One-touch fitting	Brass fitting	ø8*1	ø16	ø6	ø4*3	
B10			ø10				
G8		Stainless steel fitting	ø8*1				
G10			ø10				
BN9	Inch size Threaded One-touch fitting	Brass fitting	ø5/16**1	ø1/2"	ø1/4"	ø5/32**3	
BN11			ø3/8"				
GN9		Stainless steel fitting	ø5/16**1				
GN11			ø3/8"				

\*1 ø8 and ø5/16" One-touch fitting are common for mm and inch size.

\*2 In the case of external pilot type (made to order), fittings are attached to the X and PE ports according to the above fitting type.

\*3 For the VENT port ø4 and ø5/32", the same fitting is used.

#### ⑦ Mounting option

Symbol	Mounting option
Nil	None
L*1	Mounting leg (90 mm)

\*1 Mounting legs are shipped together with the product.



**Made to Order**  
(Refer to page 258 for details.)

Specifications
External pilot
Coil type: With power-saving circuit (Continuous duty type, 0.1 W)



This is an IP69K compliant product. The manifold and valves are ordered as a set.

## How to Order Valves

**JSY5** 1 0 3     - 5 U - H

① ② ③ ④ ⑤ ⑥ ⑦

• Clean design manifold valve identification symbol

### ① Type of actuation

<b>1</b>		Single
<b>2</b>	2-position	Double
<b>3</b>		Closed center
<b>4</b>	3-position	Exhaust center
<b>5</b>		Pressure center
<b>A</b> *1	4-position dual 3-port	N.C./N.C.
<b>B</b> *1		N.O./N.O.
<b>C</b> *1		N.C./N.O.

\*1 External pilot specification is not applicable for 4-position dual 3-port valves.

### ② Body type

<b>0</b>	Base mounted (For plug-in)
----------	----------------------------

### ④ Pilot type

<b>Nil</b>	Internal pilot
<b>R</b> *1	External pilot

\*1 The external pilot specification should be ordered as made to order.

### ③ Pilot valve exhaust method

<b>3</b>	Pilot valve common exhaust
----------	----------------------------

### ⑤ Coil type

<b>Nil</b>	Standard
<b>T</b> *1	With power-saving circuit (Continuous duty type)

\*1 "T" (With power-saving circuit) should be ordered as made to order.

### ⑥ Rated voltage

<b>5</b>	24 VDC
----------	--------

### ⑦ Light/surge voltage suppressor

Symbol	With light	Surge voltage suppressor	Common specification
<b>U</b>			Non-polar
<b>Z</b>	●	●	Positive common
<b>NZ</b>			Negative common

\* Only "Z" and "NZ" types are available with a power-saving circuit.

\* For fieldbus type manifold, select non-polar (U) or negative common (NZ).

## ⚠ Caution

• If the valve will be continuously energized, please be sure to use the power-saving circuit (continuous duty type). Refer to Made to Order on page 258.

⚠ Protective class class III (Mark: ⚡)

## How to Order Manifold Assembly

### Example (JJ5SY5-H11L105-□)

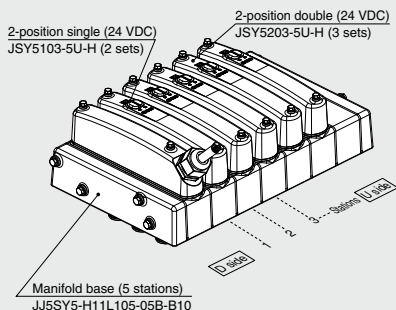

This is an IP69K compliant product. The manifold and valves are ordered as a set.

### Ordering example

JJ5SY5-H11L105-05B-B10... 1 set (Type H11 5-station manifold base part no.)

\* JSY5103-5U-H... 2 sets (2-position single part no.)

\* JSY5203-5U-H... 3 sets (2-position double part no.)

— The asterisk denotes the symbol for the assembly. Prefix it to the part numbers of the valve, etc.

• For the valve arrangement, the valve closest to the D side is considered the 1st station.

• Under the manifold part number, state the valves to be mounted in order starting with the 1st station as shown in the figure above. If the arrangement becomes too complicated, specify the details on a manifold specification sheet.

## Manifold Specifications

In order to assemble complex manifold patterns, or for arrangements including 5-port type manifold blocks, please use the manifold specification sheet.



Scan here to download.

# JSY5000-H Series

## Dimensions: Lead Wire Type



JJ5SY5-H11L1 □ Stations  $\begin{matrix} \text{D} & \text{02F, B} \\ \text{B} & \text{G, BN} \\ & \text{GN} \end{matrix}$  (L)

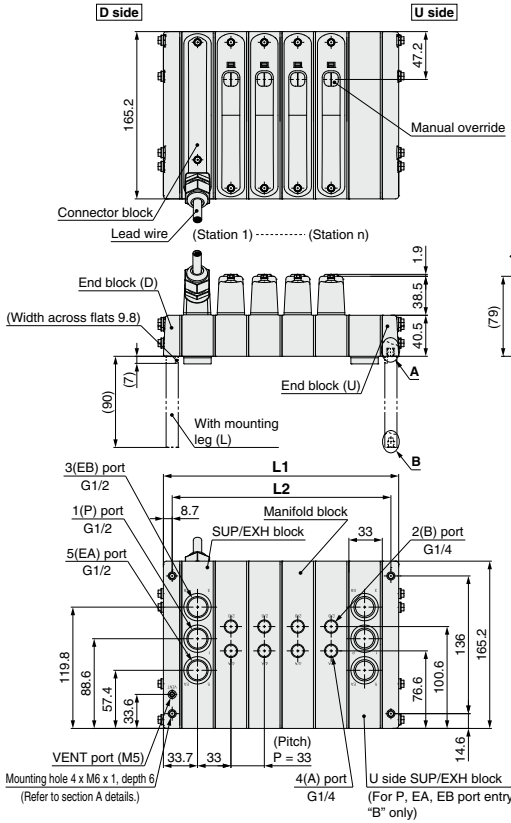

### Section A details

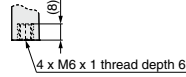

### Section B details

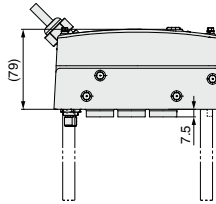
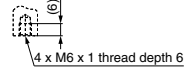

\* Refer to page 240 for the panel cutout dimensions for direct mounting.

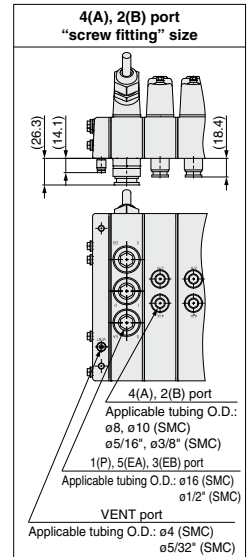

\* These figures show the "JJ5SY5-H11L105-04B-B10."

### 1(P), 5(EA), 3(EB) Port Entry: D Side (SUP/EXH Block)

#### L: Dimensions

n: Number of stations

L \ n	2	3	4	5	6	7	8	9	10
L1	133.4	166.4	199.4	232.4	265.4	298.4	331.4	364.4	397.4
L2	117	150	183	216	249	282	315	348	381

### 1(P), 5(EA), 3(EB) Port Entry: Both Sides (SUP/EXH Block)

#### L: Dimensions

n: Number of stations

L \ n	2	3	4	5	6	7	8	9	10	11	12	13	14	15	16
L1	166.4	199.4	232.4	265.4	298.4	331.4	364.4	397.4	430.4	463.4	496.4	529.4	562.4	595.4	628.4
L2	150	183	216	249	282	315	348	381	414	447	480	513	546	579	612

## Electrical Wiring Specifications

### Lead wire

#### 34 cores

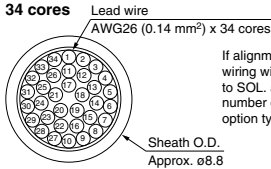

If alignment is not specified, the internal wiring will be double wiring (connected to SOL. a and SOL. b) regardless of number of stations, valve types, and option types.

### Electrical characteristics

Item	Property
Conductor resistance $\Omega/\text{km}, 20^\circ\text{C}$	143 or less
Voltage limit V, 1 minute, AC	2000
Insulation resistance $\text{M}\Omega/\text{km}, 20^\circ\text{C}$	10 or more

\* Cannot be used for movable wiring  
The minimum bending radius of the cable is 55 mm.

Station	Lead wire no.	Polarity	Lead wire color	Printed mark (Both sides)	
				Type	Color
Station 1	SOL.a	1 (-)	Orange	-	Red
	SOL.b	2 (+)		-	Black
Station 2	SOL.a	3 (-)	Light gray	-	Red
	SOL.b	4 (+)		-	Black
Station 3	SOL.a	5 (-)	White	-	Red
	SOL.b	6 (+)		-	Black
Station 4	SOL.a	7 (-)	Yellow	-	Red
	SOL.b	8 (+)		-	Black
Station 5	SOL.a	9 (-)	Pink	-	Red
	SOL.b	10 (+)		-	Black
Station 6	SOL.a	11 (-)	Orange	---	Red
	SOL.b	12 (+)		---	Black
Station 7	SOL.a	13 (-)	Light gray	---	Red
	SOL.b	14 (+)		---	Black
Station 8	SOL.a	15 (-)	White	---	Red
	SOL.b	16 (+)		---	Black
Station 9	SOL.a	17 (-)	Yellow	---	Red
	SOL.b	18 (+)		---	Black
Station 10	SOL.a	19 (-)	Pink	---	Red
	SOL.b	20 (+)		---	Black
Station 11	SOL.a	21 (-)	Orange	---	Red
	SOL.b	22 (+)		---	Black
Station 12	SOL.a	23 (-)	Light gray	---	Red
	SOL.b	24 (+)		---	Black
Station 13	SOL.a	25 (-)	White	---	Red
	SOL.b	26 (+)		---	Black
Station 14	SOL.a	27 (-)	Yellow	---	Red
	SOL.b	28 (+)		---	Black
Station 15	SOL.a	29 (-)	Pink	---	Red
	SOL.b	30 (+)		---	Black
Station 16	SOL.a	31 (-)	Orange	---	Red
	SOL.b	32 (+)		---	Black
	COM	33 (+)	Light gray	---	Red
	COM	34 (+)		---	Black

Positive common Negative common

\* For negative common specification, a valve for negative common or a valve without polarity should be used.

# JSY5000-H Series



## Dimensions: Fieldbus Type (IO-Link)

JJ5SY5-H11SKAN- Stations  $\begin{matrix} \text{D} & \text{02F, B} \\ \text{B} & \text{G}, \text{BN} \\ \text{GN} & \end{matrix}$  (L)

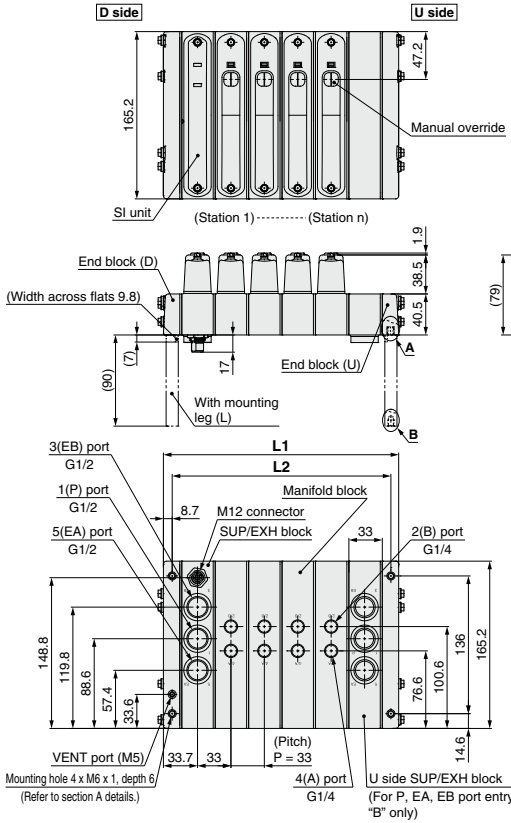

### Section A details

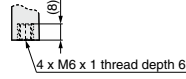

### Section B details

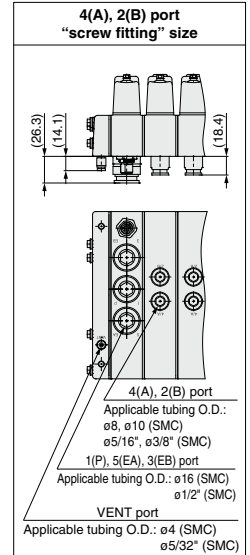
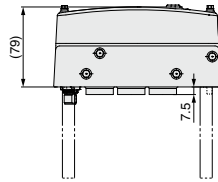
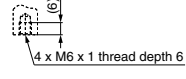

\* Refer to page 240 for the panel cutout dimensions for direct mounting.

### 1(P), 5(EA), 3(EB) Port Entry: D Side (SUP/EXH Block)

#### L: Dimensions

n: Number of stations

L \ n	2	3	4	5	6	7	8	9	10
L1	133.4	166.4	199.4	232.4	265.4	298.4	331.4	364.4	397.4
L2	117	150	183	216	249	282	315	348	381

### 1(P), 5(EA), 3(EB) Port Entry: Both Sides (SUP/EXH Block)

#### L: Dimensions

n: Number of stations

L \ n	2	3	4	5	6	7	8	9	10	11	12	13	14	15	16
L1	166.4	199.4	232.4	265.4	298.4	331.4	364.4	397.4	430.4	463.4	496.4	529.4	562.4	595.4	628.4
L2	150	183	216	249	282	315	348	381	414	447	480	513	546	579	612

\* These figures show the "JJ5SY5-H11SKAN-04B-B10."





# JSY5000-H Series

## Dimensions: Panel Cutout Dimensions

JJ5SY5-H11L1 □ Stations  $\frac{D}{B}$ (R) -  $\frac{02F, B}{G, BN}$  □ (L)  
GN □

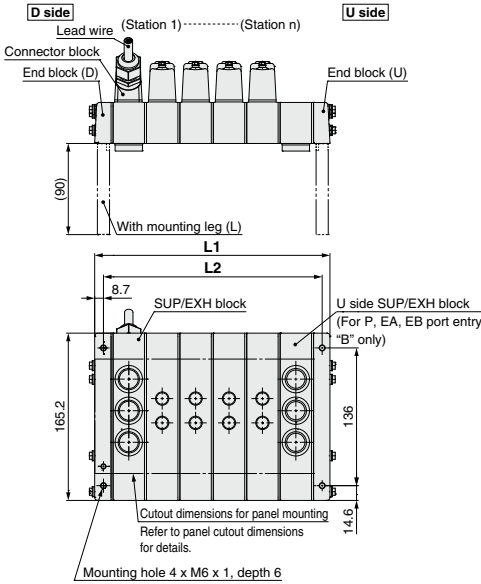

JJ5SY5-H11SKAN □ Stations  $\frac{D}{B}$ (R) -  $\frac{02F, B}{G, BN}$  □ (L)  
GN □

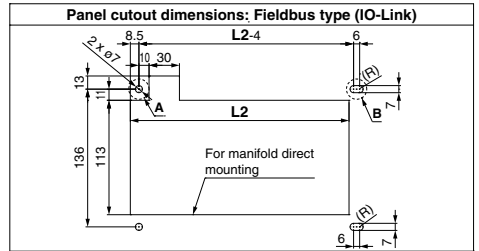
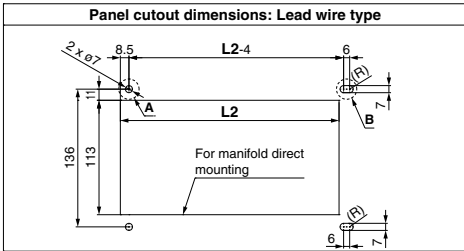
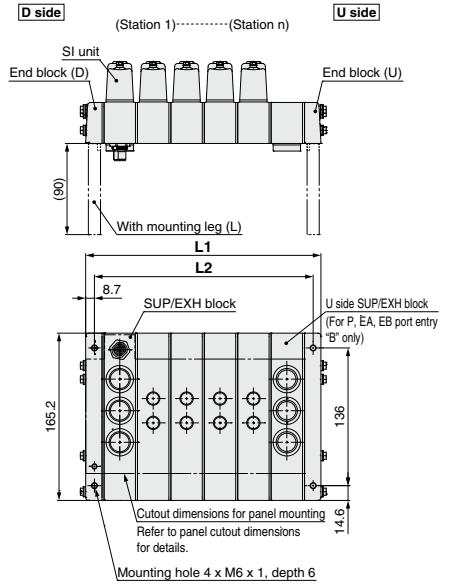

\* When mounting with the mounting leg (L), only the leg mounting holes (round/elongated) are machined.

\* When mounting with the mounting leg (L), only the leg mounting holes (round/elongated) are machined.

Section A mounting hole details    Section B mounting hole details



\* Tolerance: ±0.2

### 1(P), 5(EA), 3(EB) Port Entry: D Side (SUP/EXH Block)

L: Dimensions n: Number of stations

L \ n	2	3	4	5	6	7	8	9	10
L1	133.4	166.4	199.4	232.4	265.4	298.4	331.4	364.4	397.4
L2	117	150	183	216	249	282	315	348	381

### 1(P), 5(EA), 3(EB) Port Entry: Both Sides (SUP/EXH Block)

L: Dimensions n: Number of stations

L \ n	2	3	4	5	6	7	8	9	10	11	12	13	14	15	16
L1	166.4	199.4	232.4	265.4	298.4	331.4	364.4	397.4	430.4	463.4	496.4	529.4	562.4	595.4	628.4
L2	150	183	216	249	282	315	348	381	414	447	480	513	546	579	612

## Dimensions: External Pilot (Made to Order)

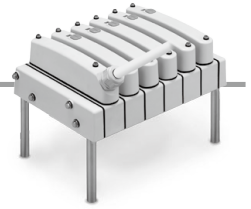

**JJ5SY5-H11** L1  SKAN  Stations  D  02F, B  R-G  GN  (L)

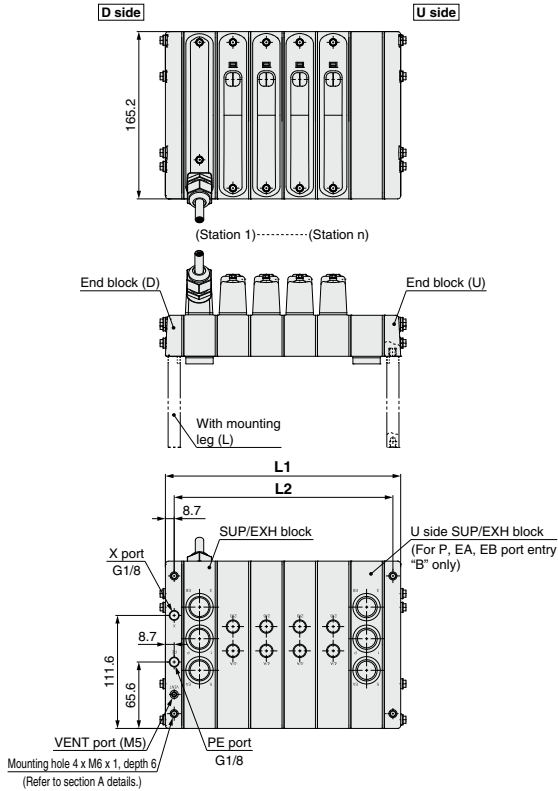

\* Refer to page 240 for panel cutout dimensions.

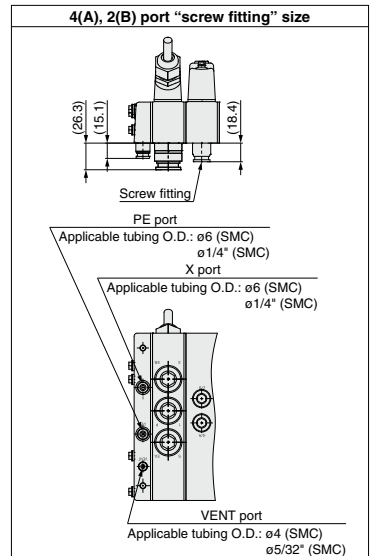
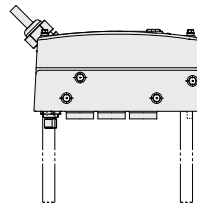

\* These figures show the "JJ5SY5-H11L105-04BR-B10."

### 1(P), 5(EA), 3(EB) Port Entry: D Side (SUP/EXH Block)

**L: Dimensions** n: Number of stations

L \ n	2	3	4	5	6	7	8	9	10
<b>L1</b>	133.4	166.4	199.4	232.4	265.4	298.4	331.4	364.4	397.4
<b>L2</b>	117	150	183	216	249	282	315	348	381

### 1(P), 5(EA), 3(EB) Port Entry: Both Sides (SUP/EXH Block)

**L: Dimensions** n: Number of stations

L \ n	2	3	4	5	6	7	8	9	10	11	12	13	14	15	16
<b>L1</b>	166.4	199.4	232.4	265.4	298.4	331.4	364.4	397.4	430.4	463.4	496.4	529.4	562.4	595.4	628.4
<b>L2</b>	150	183	216	249	282	315	348	381	414	447	480	513	546	579	612

# Sub-plate (Single Unit) [IP69K Compliant]



## Sub-plate Specifications

Type		Plug-in single unit type with M12 plug connector
SUP/EXH port type		1(P), 5, 3(EA, EB) individual port
Internal wiring		Positive common Negative common (Refer to the pin arrangement on page 243.)
Port size	1(P), 5/3(EA/EB)	G1/4 (Based on ISO 16030)
	4(A), 2(B)	
Enclosure		IP69K (Based on IEC/EN 60529/ISO 20653)
External parts material		Resin parts: PA, Metal parts: Stainless steel 316, Rubber parts: EPDM

## Sub-plate Flow Rate Characteristics/Weight

Port size		Flow rate characteristics				Weight: g*1
1, 5, 3 (P, EA, EB)	4, 2 (A, B)	1 → 4, 2 (P → A, B)		4, 2 → 5, 3 (A, B → EA, EB)		
		C [dm <sup>3</sup> /(s·bar)]	b	C [dm <sup>3</sup> /(s·bar)]	b	
G1/4	G1/4	6.75	0.31	6.53	0.22	180

\*1 Weight without fittings, valve, and M12 cable. Valve weight can be added from page 230.

**How to Order Sub-plates (With Valve/Valve Cover)**

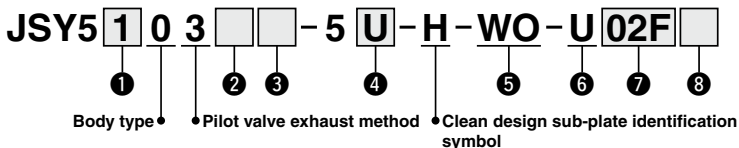

**1 Type of actuation**

<b>1</b>	2-position	Single
<b>2</b>		Double
<b>3</b>	3-position	Closed center
<b>4</b>		Exhaust center
<b>5</b>		Pressure center
<b>A</b> *1	4-position dual 3-port	N.C./N.C.
<b>B</b> *1		N.O./N.O.
<b>C</b> *1		N.C./N.O.

\*1 External pilot specification is not applicable for 4-position dual 3-port valves.

**4 Light/surge voltage suppressor**

Symbol	With light	Surge voltage suppressor	Common specification
<b>U</b>	•	•	Non-polar
<b>Z</b>	•	•	Positive common
<b>NZ</b>	•	•	Negative common

\* Only "Z" and "NZ" types are available with a power-saving circuit.

**7 1(P), 4(A), 2(B), 5(EA), 3(EB) port size**  
**[Thread piping/One-touch fitting (Metric/Inch size)]**

Symbol	Fitting specifications	P, A, B, EA, EB port One-touch fitting size	Note	
			X, PE*2 port	VENT port
<b>02F</b>	Without fitting	G1/4 Thread piping	M5 Thread piping	M5 Thread piping
<b>B8</b>	Metric size Threaded One-touch fitting	Brass fitting	ø4	ø4*3
<b>B10</b>		ø8*1		
<b>G8</b>		Stainless steel fitting		
<b>G10</b>		ø10		
<b>BN9</b>	Inch size Threaded One-touch fitting	Brass fitting	ø5/32"	ø5/32**3
<b>BN11</b>		ø5/16**1		
<b>GN9</b>		ø3/8"		
<b>GN11</b>		Stainless steel fitting		
<b>GN11</b>		ø5/16**1		
<b>GN11</b>		ø3/8"		

\*1 For B8/G8 (ø8) and BN9/GN9 (ø5/16"), the same fitting is used for them.

\*2 In the case of external pilot type, fittings are attached to the X and PE ports according to the above fitting type.

\*3 For X, PE port and VENT port of ø4 and ø5/32", the same fitting is used.

**2 Pilot type**

<b>Nil</b>	Internal pilot
<b>R</b> *1	External pilot

\*1 The external pilot specification should be ordered as made to order.

**3 Coil type**

<b>Nil</b>	Standard
<b>T</b> *1	With power-saving circuit (Continuous duty type)

\*1 "T" (With power saving circuit) should be ordered as made to order.

**5 Wiring specification**

<b>WO</b>	Without M12 connector cable
-----------	-----------------------------

**6 Port location**

<b>U</b>	Bottom ported
----------	---------------

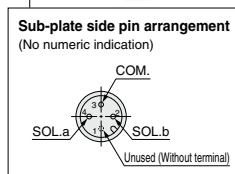
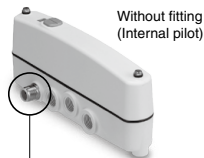

\* Plug connector type

**8 Mounting option**

<b>Nil</b>	None
<b>L</b> *1	Mounting leg (90 mm)

\*1 Mounting legs are shipped together with the product.

**Recommended M12 Connector Cables (IP69K and FDA-compliant products)**



Cable length	PHOENIX CONTACT Product no.	PHOENIX CONTACT Order no.	Note
1.5 m	SAC-4P-1,5-600/M12FS HD	1403956	Produced upon receipt of order
3 m	SAC-4P-3,0-600/M12FS HD	1403957	
5 m	SAC-4P-5,0-600/M12FS HD	1403958	
10 m	SAC-4P-10,0-600/M12FS HD	1403959	

**Caution** Order the Phoenix Contact products from the manufacturer or the distributors.

# JSY5000-H Series

## Dimensions: Sub-plate

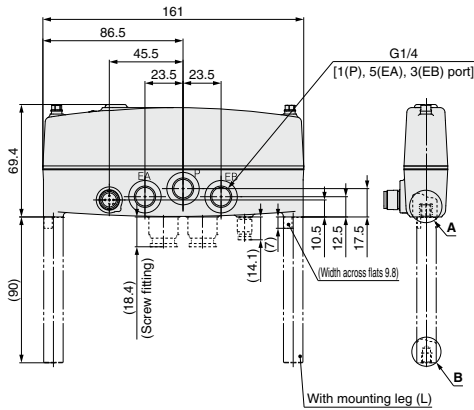
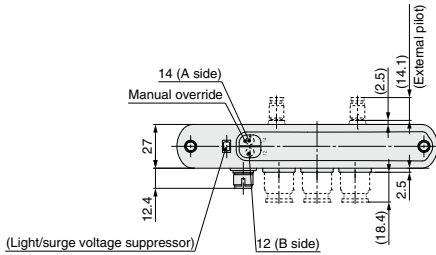
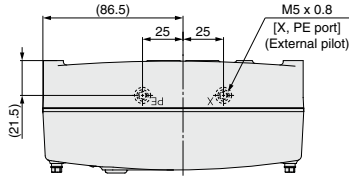

### Sub-plate side pin arrangement (No numeric indication)

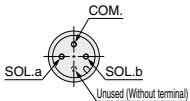

\* Plug connector type

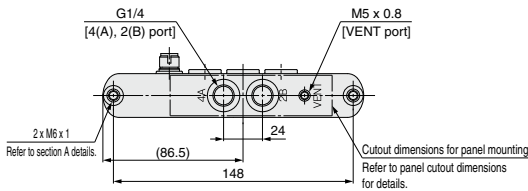

### Section A details

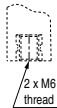

### Section B details

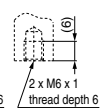

### Panel cutout dimensions: Sub-plate (Single unit)

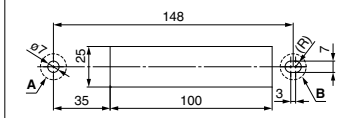

### Section A mounting hole details



### Section B mounting hole details



\* Tolerance: ±0.2

\* When mounting with the mounting leg (L), only the leg mounting holes (round/elongated) are machined.





# JSY5000-H Series Manifold Exploded View

## Wiring

### Lead Wire Type

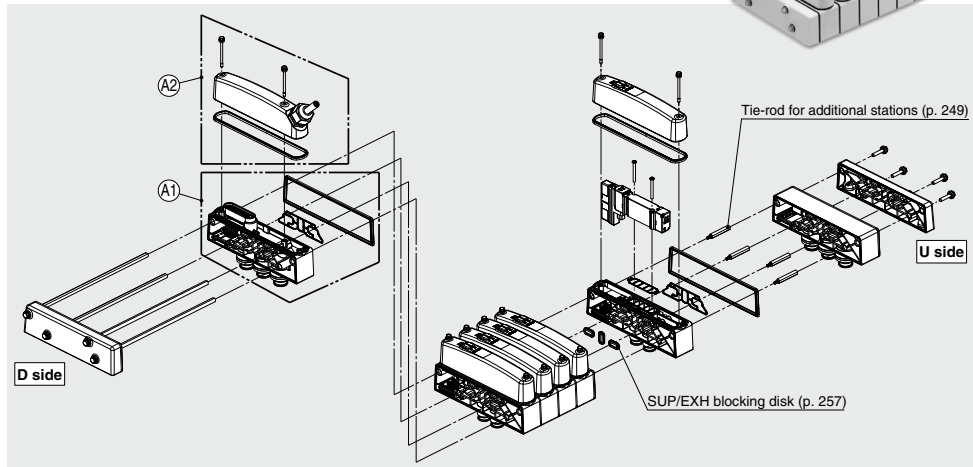

## Manifold Parts Nos.

### A1 SUP/EXH block assembly

**JSY51M - 101P - 1 A - 04F**

Lead wire type

1(P), 5(EA), 3(EB) port size

[Thread piping/One-touch fitting (Metric/Inch size)]

Symbol	Fitting specifications		P, EA, EB port One-touch fitting size
<b>04F</b>	Without fitting		G1/2, Thread piping
<b>B12</b>	Metric size Threaded	Brass fitting	ø12
<b>B16</b>		Stainless steel fitting	ø16
<b>G12</b>	One-touch fitting	Stainless steel fitting	ø12
<b>G16</b>		Brass fitting	ø16
<b>BN11</b>	Inch size Threaded	Brass fitting	ø3/8"
<b>BN13</b>		Stainless steel fitting	ø1/2"
<b>GN11</b>	One-touch fitting	Stainless steel fitting	ø3/8"
<b>GN13</b>		Brass fitting	ø1/2"

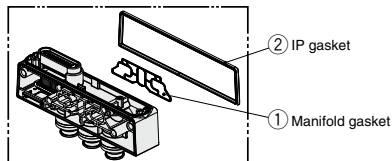

Gaskets are mounted.  
(When mounting the manifold, make sure that the gasket is not misaligned, damaged, forgotten to be attached, and that there are not foreign objects.)

### SUP/EXH block assembly accessories and the number of accessories

Accessories	Quantity (Mounted)
① Manifold gasket	1 pc.
② IP gasket	1 pc.

\* Refer to page 249 for ordering single unit.

246

### A2 Lead wire connector block assembly

**JSY51M - 114P - 1A - 1 - 05**

Lead wire length

<b>05</b>	5 m
<b>10</b>	10 m
<b>15</b>	15 m

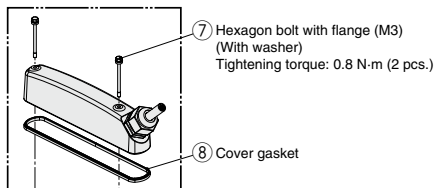

Hexagon bolts with flange and the gasket are mounted.  
(When mounting the manifold, make sure that the gasket is not misaligned, damaged, forgotten to be attached, and that there are not foreign objects.)

### Lead wire connector block assembly accessories and the number of accessories

Accessories	Quantity (Mounted)
⑦ Hexagon bolt with flange (M3) (With washer)	2 pcs.
⑧ Cover gasket	1 pc.

\* Refer to page 249 for ordering single unit.

## Wiring

### Fieldbus Type

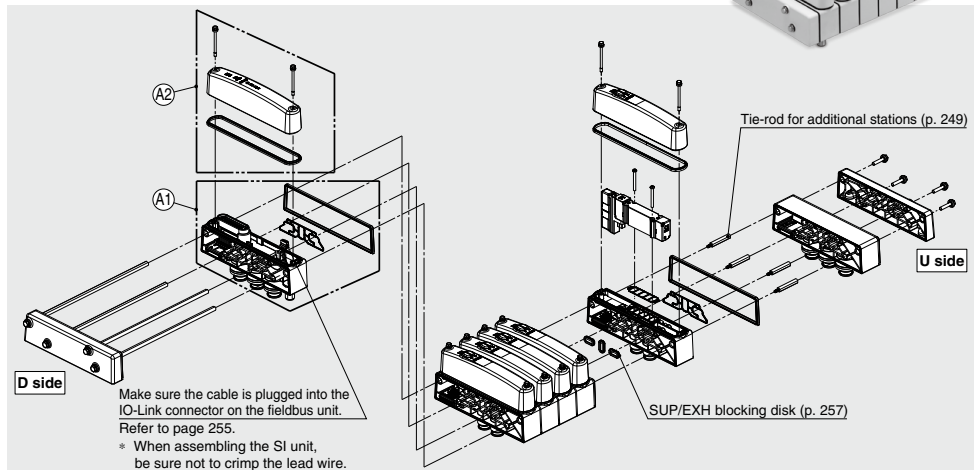

## Manifold Parts Nos.

### A1 SUP/EXH block assembly

**JSY51M - 101P - 2 A - 04F**

Fieldbus type

1(P), 5(EA), 3(EB) port size

[Thread piping/One-touch fitting (Metric/Inch size)]

Symbol	Fitting specifications	P, EA, EB port One-touch fitting size
<b>04F</b>	Without fitting	G1/2, Thread piping
<b>B12</b>	Metric size Threaded	Brass fitting
<b>B16</b>		Stainless steel fitting
<b>G12</b>	One-touch fitting	Brass fitting
<b>G16</b>		Stainless steel fitting
<b>BN11</b>	Inch size Threaded	Brass fitting
<b>BN13</b>		Stainless steel fitting
<b>GN11</b>	One-touch fitting	Brass fitting
<b>GN13</b>		Stainless steel fitting

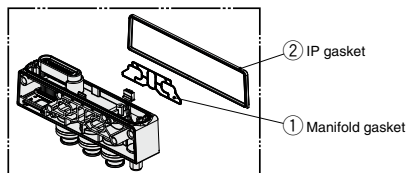

Gaskets are mounted.

(When mounting the manifold, make sure that the gasket is not misaligned, damaged, forgotten to be attached, and that there are not foreign objects.)

### SUP/EXH block assembly accessories and the number of accessories

Accessories	Quantity (Mounted)
① Manifold gasket	1 pc.
② IP gasket	1 pc.

\* Refer to page 249 for ordering single unit.

### A2 Fieldbus system

**EX430 - S IL1** \* Refer to page 255 for details.

### Communication protocol

Symbol	Protocol	Output polarity	Communication connector	Manifold symbol
<b>IL1</b>	IO-Link	Source/PNP (Negative common)	M12*1	SKAN

\*1 The M12 connector is located on the SUP/EXH block on the D side.

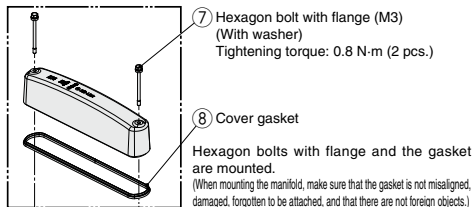

### SI unit accessories and the number of accessories

Accessories	Quantity (Mounted)
⑦ Hexagon bolt with flange (M3) (With washer)	2 pcs.
⑧ Cover gasket	1 pc.

\* Refer to page 249 for ordering single unit.

### Communication cable (IO-Link compatible, With M12 connector on both sides (plug/socket))

#### [Recommended IP69K and FDA-compliant products]

Cable length	PHOENIX CONTACT Product no.	PHOENIX CONTACT Order no.	Note
1.5 m	SAC-5P-M12MS/1,5-600/M12FS HD	1404065	Produced upon receipt of order
3 m	SAC-5P-M12MS/3,0-600/M12FS HD	1404066	
5 m	SAC-5P-M12MS/5,0-600/M12FS HD	1413144	
10 m	SAC-5P-M12MS/10,0-600/M12FS HD	1413143	



**Caution**

Order the Phoenix Contact products from the manufacturer or the distributors.

## Manifold Exploded View (Common Parts)

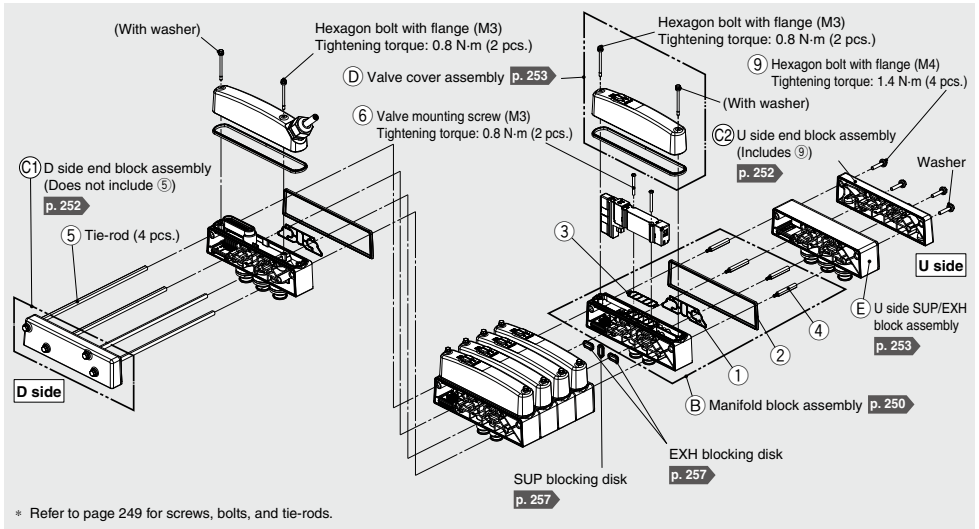

## How to Increase Manifolds

- 1 Loosen the hexagon bolt with flange ⑨ on the U side, and remove the ② U side end block assembly.  
(For SUP/EXH from both sides, remove the ⑤ U side SUP/EXH block assembly.)  
\* Do not loosen the hexagon bolt with flange of D side as the tie-rod is fixed to the ① D side end block assembly.
- 2 Screw in ④ tie-rods for additional stations to the ⑤ tie-rod of the manifold.  
(Screw them in until there is no gap between the tie-rods.)
- 3 Connect ⑥ manifold block assembly and ② U side end block assembly that need to be added, and tighten ⑨ hexagon bolt with flange on the U side. For SUP/EXH from both sides, also connect the ⑤ U side SUP/EXH block. (4 places, more than 2 turns)  
(Make sure that the washers are assembled to the hexagon bolt with flange.)  
(When mounting the manifold, make sure that the gasket is not misaligned, damaged, forgotten to be attached, and that there are not foreign objects.)

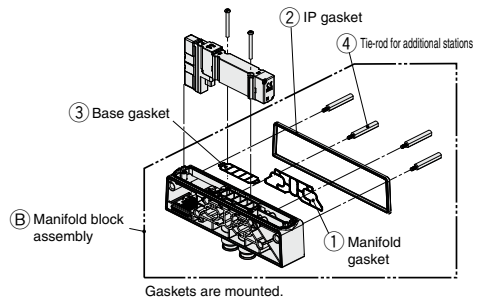

### Manifold block assembly

No.	Description	Quantity
①	Manifold gasket	1 pc. (Mounted)
②	IP gasket	1 pc. (Mounted)
③	Base gasket	1 pc. (Mounted)
④	Tie-rod for additional stations	4 pcs. (Included)

\* Refer to page 249 for ordering single unit.

Hexagon bolt with flange (M4) Tightening torque: 1.4 N-m  
(M3) Tightening torque: 0.8 N-m

## ⚠ Caution

1. Be sure to shut off the power and air supplies before disassembly. Furthermore, since air may remain inside the actuator, piping, and manifold, confirm that the air is completely exhausted before performing any work.
2. When disassembly and assembly are performed, air leakage may result if the tightening of the hexagon bolt with flange is inadequate.
3. Rubber parts are attached to the metal parts of the washer. If they are misaligned or dislodged, return them to their normal position.

## Manifold Parts Nos.

No.	Description	Part no.	Note
①	<b>Manifold block assembly</b>	<b>Manifold gasket</b>	JSY51M-109P-1A For 10 valves (10 pcs.)
②		<b>IP gasket</b>	JSY51M-109P-3A For 10 valves (10 pcs.)
③		<b>Base gasket</b>	JSY51M-9P-1A For 10 valves (10 pcs.)
④		<b>Tie-rod for additional stations</b>	JSY51M-49P-2A For 1 station (4 pcs.)
⑤	<b>Tie-rod</b>	JSY51M-49P-1-□A	Refer to the table below for the number of □. 4 tie-rods per manifold
⑥	<b>Valve mounting screw</b>	JSY51V-23-1A (M3 x 29)	For 10 valves (20 pcs.)
⑦	<b>Hexagon bolt with flange (M3) (With washer) (For connector block/SI unit cover/valve cover)</b>	JSY51M-123P-1A (M3 x 40)	For 5 valves (10 pcs.)
⑧	<b>Cover gasket (For connector block/SI unit cover/valve cover)</b>	JSY51M-109P-2A	For 10 valves (10 pcs.)
⑨	<b>Hexagon bolt with flange (M4) (With washer) (For end block)</b>	JSY51M-123P-2A (M4 x 24)	8 bolts per manifold

### Tie-rod Order Nos. (1 set includes 4 pcs.)

Manifold stations	Tie-rod part no.	
	SUP/EXH block assembly: D side	SUP/EXH block assembly: B (Both sides)
2	JSY51M-49P-1-2A	JSY51M-49P-1-3A
3	JSY51M-49P-1-3A	JSY51M-49P-1-4A
4	JSY51M-49P-1-4A	JSY51M-49P-1-5A
5	JSY51M-49P-1-5A	JSY51M-49P-1-6A
6	JSY51M-49P-1-6A	JSY51M-49P-1-7A
7	JSY51M-49P-1-7A	JSY51M-49P-1-8A
8	JSY51M-49P-1-8A	JSY51M-49P-1-9A
9	JSY51M-49P-1-9A	JSY51M-49P-1-10A
10	JSY51M-49P-1-10A	JSY51M-49P-1-11A
11	For a manifold of 11 or more stations, only the SUP/EXH block assembly: B (Both sides) can be selected.	JSY51M-49P-1-12A
12		JSY51M-49P-1-13A
13		JSY51M-49P-1-14A
14		JSY51M-49P-1-15A
15		JSY51M-49P-1-16A
16		JSY51M-49P-1-17A

### ■ Mounting leg (4 pcs./set): For manifold

## JSY51M – 115P – 1A

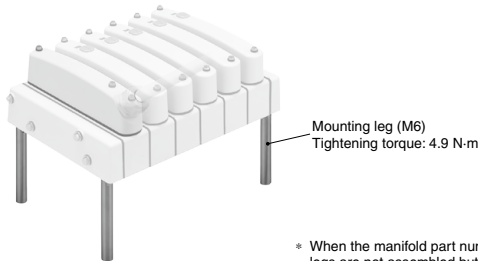

\* When the manifold part number (L) is ordered, the mounting legs are not assembled but included in the same package.

# JSY5000-H Series

## Manifold Parts Nos.

### Ⓑ Manifold block assembly

JSY51M - 102P - **1** D A - **02F**

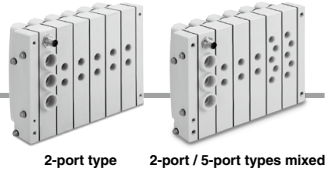

#### Piping specification

1	2-port type (4(A), 2(B) port)
2	5-port type (1(P), 4(A), 2(B), 5(EA), 3(EB) port)

#### Double wiring

#### With blocking disk (Laser marking)

Nil	Without blocking disk (Without laser marking)
P	With SUP blocking disk
E	With EXH blocking disk
PE	With SUP/EXH blocking disk

\* Laser printed blocking disk symbol on the piping surface of the fitting of A and B port.

For blocking disks, refer to "Manifold Options" on page 257.

#### Manifold block port size

#### [Thread piping/One-touch fitting (Metric/Inch size)]

Symbol	Fitting specifications		Manifold block port size	
			2-port type	5-port type
			A, B port	P, A, B, EA, EB port
02F	Without fitting		G1/4 Thread piping	
B8	Metric size Threaded One-touch fitting	Brass fitting	ø8 <sup>*1</sup>	
B10			ø10	
G8		Stainless steel fitting	ø8 <sup>*1</sup>	
G10			ø10	
BN9	Inch size Threaded One-touch fitting	Brass fitting	ø5/16 <sup>*1</sup>	
BN11			ø3/8"	
GN9		Stainless steel fitting	ø5/16 <sup>*1</sup>	
GN11			ø3/8"	

\*1 ø8 and ø5/16" One-touch fitting are common for mm and inch size.

### Ⓑ Manifold block assembly (All parts inside ----- are included.)

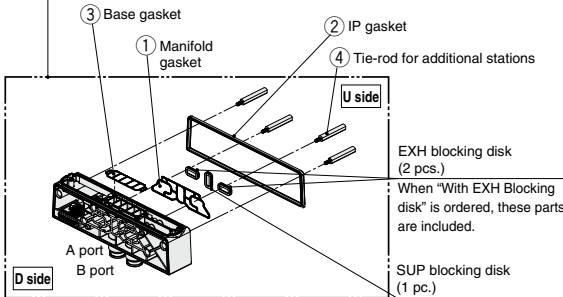

Gaskets are mounted.

(When mounting the manifold, make sure that the gasket is not misaligned, damaged, forgotten to be attached, and that there are not foreign objects.)

### Manifold block assembly accessories and the number of accessories

Accessories	Quantity
① Manifold gasket	1 pc. (Mounted)
② IP gasket	1 pc. (Mounted)
③ Base gasket	1 pc. (Mounted)
④ Tie-rod for additional stations	4 pcs. (Included)

\* Refer to page 249 for ordering single unit.



## Manifold Parts Nos.

### <Manifold block port surface>

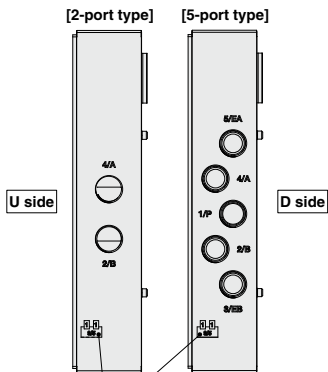

Blocking disk identification symbol (Laser marking)

This is the symbol to indicate the location of the manifold block that contains the blocking disk.

- \* The blocking disk is mounted to U side.

SUP blocking disk  
(identification symbol)



EXH blocking disk  
(identification symbol)



SUP/EXH blocking disk  
(identification symbol)



### [2-port / 5-port types mixed]

#### <Example>

Use a blocking disk in the 1(P) SUP passage for each additional different pressure required.

Use blocking disk in the 5(EA)/3(EB) EXH passages for individual valve exhaust.

5-port type manifold blocks can be used to provide additional SUP/EXH if low flow rate occurs.

- \* Specify **the arrangement and blocking disk position in the manifold specification sheet.**

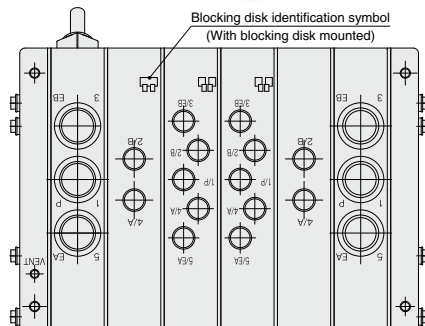
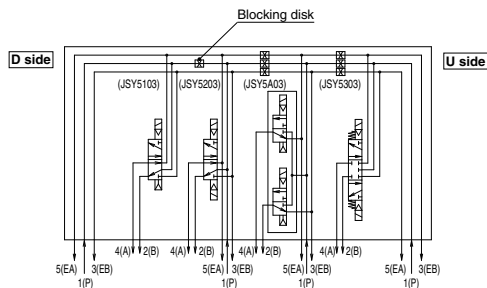

# JSY5000-H Series

## Manifold Parts Nos.

### ① D side end block assembly

JSY51M – 103P – 1    A – M5

Pilot type	
Nil	Internal pilot
R*1	External pilot

\*1 The external pilot specification should be ordered as made to order.

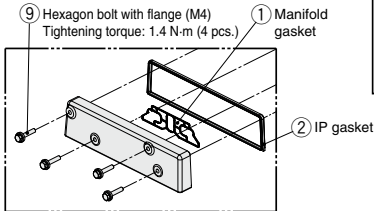

Gaskets are mounted.  
(Make sure that the washers are assembled to the hexagon bolt with flange. When mounting the manifold, make sure that the gasket is not misaligned, damaged, forgotten to be attached, and that there are not foreign objects.)

#### D side end block port location



VENT port (M5) PE port (G1/8) X port (G1/8)  
(Common to internal/external pilot) (External pilot only)

#### • For internal pilot VENT port size [Thread piping/One-touch fitting (Metric/Inch size)]

Symbol	Fitting specifications		One-touch fitting size
	Without fitting		M5, Thread piping
B4	Metric size Threaded	Brass fitting	ø4*1
G4	One-touch fitting	Stainless steel fitting	
BN3	Inch size Threaded	Brass fitting	ø5/32**1
GN3	One-touch fitting	Stainless steel fitting	

\*1 For the VENT port of ø4 and ø5/32", the same fitting is used for them.

#### • For external pilot "R" (Made to order) VENT, X, PE port size [Thread piping/One-touch fitting (Metric/Inch size)]

Symbol	Fitting specifications		One-touch fitting size	
	Without fitting		VENT port	X, PE port
O1F			M5, Thread piping	G1/8, Thread piping
B6	Metric size Threaded	Brass fitting	ø4*1	ø6
G6	One-touch fitting	Stainless steel fitting		
BN7	Inch size Threaded	Brass fitting	ø5/32**1	ø1/4"
GN7	One-touch fitting	Stainless steel fitting		

\*1 For the VENT port of ø4 and ø5/32", the same fitting is used for them.

#### D side end block assembly accessories and the number of accessories

Accessories	Quantity
① Manifold gasket	1 pc. (Mounted)
② IP gasket	1 pc. (Mounted)
⑨ Hexagon bolt with flange (M4) (With washer)	4 pcs. (Included)

\* Refer to page 249 for ordering single unit.

### ② U side end block assembly

JSY51M – 103P – 2A

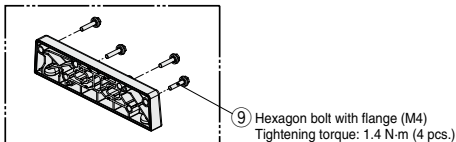

#### U side end block assembly accessories and the number of accessories

Accessories	Quantity (Included)
⑨ Hexagon bolt with flange (M4) (With washer)	4 pcs.

\* Refer to page 249 for ordering single unit.

## Manifold Parts Nos.

### ④ Valve cover assembly (For manifold/sub-plate)

**JSY51M – 104P – 1A – 1** 1 1

#### Type of actuation (Symbol laser marking)

		Without laser marking	
<b>Nil</b>			
<b>1</b>	2-position	Single	
<b>2</b>		Double	
<b>3</b>	3-position	Closed center	
<b>4</b>		Exhaust center	
<b>5</b>		Pressure center	
<b>A</b> *1	4-position dual	N.C./N.C.	
<b>B</b> *1		N.O./N.O.	
<b>C</b> *1	3-port	N.C./N.O.	

\*1 External pilot specification is not applicable for 4-position dual 3-port valves.

\* Laser printed JIS symbols corresponding to the valve switching method. (Part **A** below)

#### ● Pilot type

<b>Nil</b>	Internal pilot
<b>R</b> *1	External pilot

\*1 The external pilot specification should be ordered as made to order.

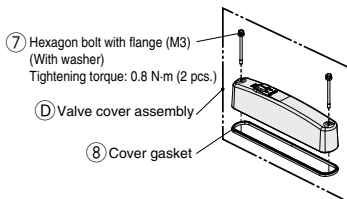

The gasket is mounted.  
(Make sure that the washers are assembled to the hexagon bolt with flange. When mounting the manifold, make sure that the gasket is not misaligned, damaged, forgotten to be attached, and that there are not foreign objects.)

### Valve cover assembly with valve (For manifold/sub-plate)

**JSY5** 03 (R)(T) – 5 1 – HC

Same as the valve part number

● With valve cover

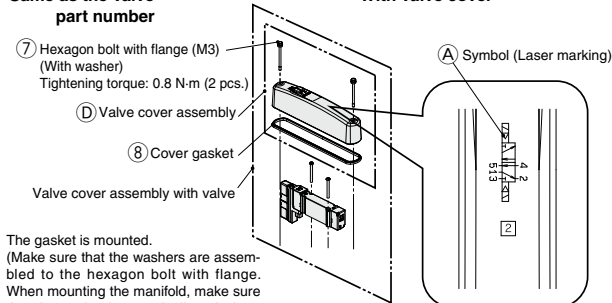

The gasket is mounted.  
(Make sure that the washers are assembled to the hexagon bolt with flange. When mounting the manifold, make sure that the gasket is not misaligned, damaged, forgotten to be attached, and that there are not foreign objects.)

\* **2** is an identification symbol for the assembly for the production department of SMC.

#### Valve cover assembly/ Valve cover assembly with valve accessories and the number of accessories

Accessories	Quantity (Mounted)
⑦ Hexagon bolt with flange (M3) (With washer)	2 pcs.
⑧ Cover gasket	1 pc.

\* Refer to page 249 for ordering single unit.

### ⑤ U side SUP/EXH block assembly

**JSY51M – 101P – 3A – 04F** 04F

● 1(P), 5(EA), 3(EB) port size

[Thread piping/One-touch fitting (Metric/Inch size)]

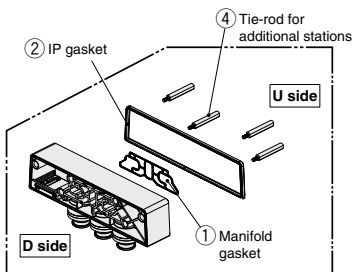

Gaskets are mounted.  
(When mounting the manifold, make sure that the gasket is not misaligned, damaged, forgotten to be attached, and that there are not foreign objects.)

Symbol	Fitting specifications		P, EA, EB port
			One-touch fitting size
<b>04F</b>	Without fitting		G1/2, Thread piping
<b>B12</b>	Metric size Threaded One-touch fitting	Brass fitting	ø12
<b>B16</b>			ø16
<b>G12</b>		Stainless steel fitting	ø12
<b>G16</b>			ø16
<b>BN11</b>	Inch size Threaded One-touch fitting	Brass fitting	ø3/8"
<b>BN13</b>			ø1/2"
<b>GN11</b>		Stainless steel fitting	ø3/8"
<b>GN13</b>			ø1/2"

#### U side SUP/EXH block assembly accessories and the number of accessories

Accessories	Quantity
① Manifold gasket	1 pc. (Mounted)
② IP gasket	1 pc. (Mounted)
④ Tie-rod for additional stations	4 pcs. (Included)

\* Refer to page 249 for ordering single unit.

# JSY5000-H Series

## Sub-plate (Single Unit) Exploded View

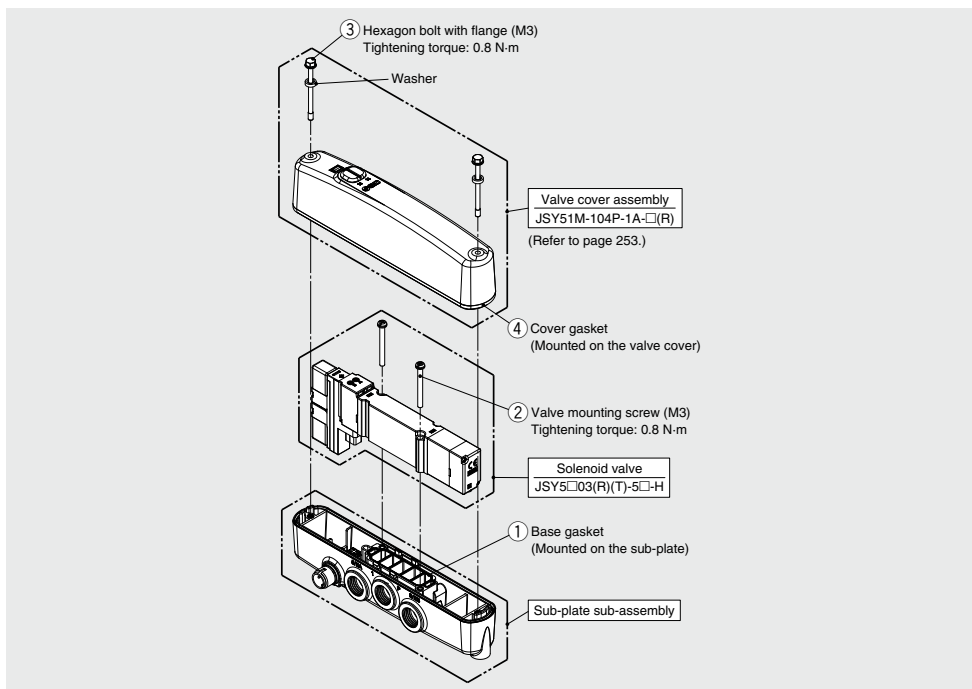

### Sub-plate Parts Nos.

No.	Description	Part no.	Note
①	<b>Base gasket</b>	JSY51M-9P-1A	For 10 valves (10 pcs.)
②	<b>Valve mounting screw</b>	JSY51V-23-1A (M3 x 29)	For 10 valves (20 pcs.)
③	<b>Hexagon bolt with flange (M3) (With washer) (For valve cover)</b>	JSY51M-123P-1A (M3 x 40)	For 5 valves (10 pcs.)
④	<b>Cover gasket (For valve cover)</b>	JSY51M-109P-2A	For 10 valves (10 pcs.)

### ■ Mounting leg (2 pcs./set): For sub-plate

## JSY51M – 115P – 2A

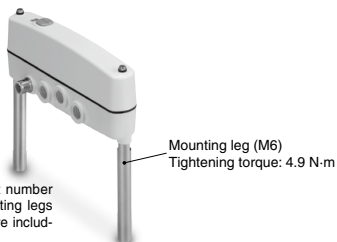

\* When the sub-plate part number (L) is ordered, the mounting legs are not assembled but are included in the same package.

# Fieldbus System: For Output

## EX430 Series



### How to Order SI Units

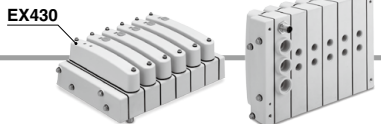

## EX430 - SIL1

### Communication protocol

Symbol	Protocol	Output polarity	Communication connector	Manifold symbol
IL1	IO-Link	Source/PNP (Negative common)	M12*1	SKAN

\*1 The M12 connector is located on the SUP/EXH block on the manifold D side.

### Specifications

Model		EX430-SIL1
Applicable system	Protocol	IO-Link (Class B)
	Version	V1.1
	Configuration file*1	IODD file
I/O occupation area (Inputs/Outputs)		0/32, 16/32*2
Communication speed		COM3/COM2*2
Communication connector specification		M12*3
Power supply for control	Power supply voltage	18 to 30 VDC
	Internal current consumption	50 mA or less
Power supply for output	Power supply voltage	22.8 to 26.4 VDC
Output	Output type	Source/PNP (Negative common)
	Number of outputs	32
	Load	Solenoid valve with surge voltage suppressor of 24 VDC, 0.4 W or less (SMC)
	Supplied voltage	24 VDC
	Supplied current	Max. 0.54 A
Environmental resistance	Operating temperature range	-10 to 50°C
	Operating humidity range	35% to 85% RH (No condensation)
	Withstand voltage	500 VAC for 1 minute between terminals and housing
	Insulation resistance	10 MΩ or more (500 VDC measured via megohmmeter) between terminals and housing
Standards		CE/UKCA marking (EMC directive/RoHS directive)
Weight		100 g

\*1 The configuration file can be downloaded from the SMC website: <https://www.smcworld.com>

\*2 A selection can be made using the setting switch.

\*3 The M12 connector is located on the SUP/EXH block on the manifold D side.

### Y Branch Connector for IO-Link

This connector is used to supply power to the valve manifold by branching the IO-Link communication cable in cases where a port class A IO-Link master is used.

This branch connector has an IP67 enclosure.

For details, refer to page 1331.



### Dimensions

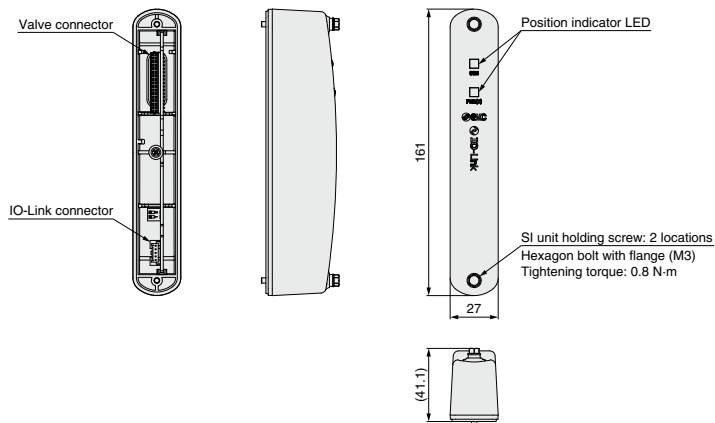

# JSY5000-H Series

# One-touch Fittings, Plugs, Tube Releasing Tools

## ■ FDA Compliant Metal One-touch Fittings Hexagon Socket Head Male Connector

Port size			Brass C3604 (Electroless nickel plating)	Stainless steel 316	
Metric size	Manifold block	2-port type: 4(A), 2(B) port 5-port type: 1(P), 4(A), 2(B), 5(EA), 3(EB) port	ø8*1	KQB2S08-G02-F	KQG2S08-G02-F
			ø10	KQB2S10-G02-F	KQG2S10-G02-F
	SUP/EXH block	1(P), 5(EA), 3(EB) port	ø12	KQB2S12-G04-F	KQG2S12-G04-F
			ø16	KQB2S16-G04-F	KQG2S16-G04-F
D side end block	VENT port X, PE port	ø4*2	KQB2S04-M5-F	KQG2S04-M5-F	
		ø6	KQB2S06-G01-F	KQG2S06-G01-F	
Inch size	Manifold block	2-port type: 4(A), 2(B) port 5-port type: 1(P), 4(A), 2(B), 5(EA), 3(EB) port	ø5/16**1	KQB2S08-G02-F	KQG2S08-G02-F
			ø3/8"	KQB2S11-G02-F-X73	KQG2S11-G02-F-X73
	SUP/EXH block	1(P), 5(EA), 3(EB) port	ø3/8"	KQB2S11-G04-F-X73	KQG2S11-G04-F-X73
			ø1/2"	KQB2S13-G04-F-X73	KQG2S13-G04-F-X73
	D side end block	VENT port X, PE port	ø5/32**2	KQB2S04-M5-F	KQG2S04-M5-F
			ø1/4"	KQB2S07-G01-F-X73	KQG2S07-G01-F-X73



Metal One-touch fitting

- \*1 For the 4(A) and 2(B) port of ø8 or ø5/16", the same fitting is used for them.  
\*2 For the VENT port of ø4 and ø5/32", the same fitting is used for them.

## ■ FDA Compliant Metal Plugs

When the plug is used, use it with a One-touch fitting.

Port size			Brass C3604 (Electroless nickel plating)	Stainless steel 316	
Metric size	Manifold block	2-port type: 4(A), 2(B) port 5-port type: 1(P), 4(A), 2(B), 5(EA), 3(EB) port	ø8*1	KQB2P-08-F	KQG2P-08
			ø10	KQB2P-10-F	KQG2P-10
	SUP/EXH block	1(P), 5(EA), 3(EB) port	ø12	KQB2P-12-F	KQG2P-12
			ø16	KQB2P-16-F	KQG2P-16
D side end block	VENT port X, PE port	ø4*2	KQB2P-04-F	KQG2P-04	
		ø6	KQB2P-06-F	KQG2P-06	
Inch size	Manifold block	2-port type: 4(A), 2(B) port 5-port type: 1(P), 4(A), 2(B), 5(EA), 3(EB) port	ø5/16**1	KQB2P-08-F	KQG2P-08
			ø3/8"	KQB2P-11-F	KQG2P-11
	SUP/EXH block	1(P), 5(EA), 3(EB) port	ø3/8"	KQB2P-11-F	KQG2P-11
			ø1/2"	KQB2P-13-F	KQG2P-13
	D side end block	VENT port X, PE port	ø5/32**2	KQB2P-04-F	KQG2P-04
			ø1/4"	KQB2P-07-F	KQG2P-07



Metal plug

- \*1 For the 4(A) and 2(B) port of ø8 or ø5/16", the same fitting is used for them.  
\*2 For the VENT port of ø4 and ø5/32", the same fitting is used for them.

## ■ Tube Releasing Tools (This tool is used for removing the tube from the 4(A) and 2(B) port.)

Part no.	TG-0608	TG-1012
Applicable tubing O.D.	ø6/ø8	ø10/ø12

- \* Tube releasing tools are not applicable for all port sizes.



TG-0608



TG-1012

Tube releasing tools

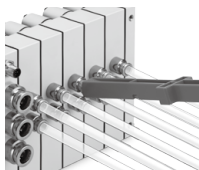

For details on the tube removal procedure, refer to the JSY1000/3000/5000 Web Catalog.

# JSY5000-H Series Manifold Options

## ■ Blanking plate

[With two mounting screws]

Used when valve additions are expected or for maintenance

### Blanking plate (Single unit)

**JSY51M - 26P - 1A**

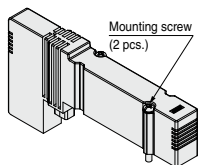

**JSY51M-26P-1A**

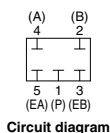

### Valve cover assembly with blanking plate

**JSY51M - 26P - 1A C**

With valve cover

For the valve cover assembly, refer to "Manifold Parts Nos." on page 253.

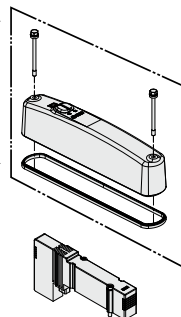

## ■ SUP/EXH blocking disk

### [SUP blocking disk]

By inserting the SUP blocking disk in the pressure supply passage of the manifold valve, can provide two different high and low pressure in one manifold.

### [EXH blocking disk]

By inserting the EXH blocking disk in the exhaust passage of the manifold valve, can separate the exhaust from the valve so it does not affect the other valves. It can also be used for the manifold for the positive pressure and vacuum mixed manifold. **(2 pieces are required to block EA/EB both sides of the EXH.)**

\* When ordering a manifold, if the blocking disk is ordered at the same time in the manifold specifications, the laser printed blocking disk symbol will be displayed in the manifold block assembly that includes the blocking disk. Refer to the manifold block assembly on page 250 for the contents.



Series	SUP blocking disk	EXH blocking disk
<b>JSY5000</b>	JSY51M-40P-2A	JSY51M-40P-2A

# JSY5000-H Series

## Made to Order

Please contact SMC for detailed dimensions, specifications, and delivery times.



### 1 External Pilot

#### How to Order Manifolds

Refer to the How to Order manifolds for each type on page 234.

#### Lead wire type

JJ5SY5 - H11L1  -   R -

#### Fieldbus type (IO-Link)

JJ5SY5 - H11SKAN -   R -

• Pilot type

R External pilot



This is an IP69K compliant product. The manifold and valves are ordered as a set.

#### How to Order Valves

JSY5  03 R  - 5   - H

• Coil type (Refer to 2.)

• Pilot type

R External pilot

\* External pilot specification is not applicable for 4-position dual 3-port valves.

\* When pilot type "R" is selected, select the external pilot type "R" for the manifold pilot type.

#### How to Order Sub-plates (With Valve/Valve Cover)

Refer to the How to Order sub-plates on page 243.

JSY5  03 R  - 5   - H - WO - U

• Coil type (Refer to 2.)

• Pilot type

R External pilot

\* External pilot specification is not applicable for 4-position dual 3-port valves.

### 2 Coil Type: With Power-Saving Circuit (Continuous Duty Type, 0.1 W)

Be sure to select the power-saving circuit type when the valve is continuously energized for long periods of time.

Be careful of the energizing time when the power-saving circuit is selected. Refer to page 260 for details.

#### How to Order Valves

JSY5  03  T - 5  Z  - H

Pilot type (See above.)

• Coil type

• Light/surge voltage suppressor and common specification

T With power-saving circuit (Continuous duty type)

Symbol	With light	Surge voltage suppressor	Common specification
Z	●	●	Positive common
NZ			Negative common

\* Only "Z" and "NZ" types are available with a power-saving circuit.





# JSY5000-H Series

## Specific Product Precautions 1

Be sure to read this before handling the products. Refer to page 7 for safety instructions and pages 8 to 14 for 3/4/5 port solenoid valve precautions.

### Environment

#### ⚠ Warning

1. Do not use valves in atmospheres of corrosive gases, chemicals\*, sea water, water vapor, or where there is direct contact with any of these.

\*1 Check section on cleaning and the product component list of the external materials used, and ensure compatibility with any chemicals used in the cleaning solution.

2. Avoid installing and using inside a food zone.

· Not installable  
Food zone: An environment where food which will be sold as merchandize, directly touches the manifold parts

· Installable  
Splash zone: An environment where food which will not be sold as merchandize, directly touches the manifold parts

Non-food zone: An environment where there is no contact with food

#### ■ IP69K (IEC/EN 60529/ISO 20653) compliant product

1. IP69K is only guaranteed to the factory condition (finished as a manifold).

2. IP69K compliant products are protected against dust and high pressure hot water. However, when using the valve, keep within the ambient temperature and fluid temperature. (No freezing)

3. IPX9K compliant products are protected against dust and high pressure hot water jetwash.

When cleaning the manifold, it is recommended to keep the distance from the washer nozzle to the manifold at least 20 cm. Wash the manifold while moving the nozzle. Do not fix the cleaning point to one place.

4. Refer to the tightening torque in the disassembly drawing of the manifold (p. 248) when increasing or decreasing the number of stations for IP69K compliance. When installing the manifold, make sure that the gasket is not misaligned, forgotten to be attached, and that there are not foreign objects.

### How to Use

#### ⚠ Caution

##### ■ VENT port

1. A VENT port is installed on the manifold so that even if a valve leaks, the leaked pressure does not accumulate inside.

2. Prevent liquid from entering the VENT port.

3. Do not block the VENT port. If the VENT port is used with the port closed, internal pressure may build up and the product gasket may come off and IP69K is not satisfied.

4. Do not pressurize the VENT port. The sealing performance of the gasket will be reduced and the IP69K may not be satisfied.

5. Do not pipe the VENT port and the exhaust port (3/5 port) in the same piping. The back pressure of the exhaust port may be applied to the VENT port, increasing the internal pressure.



### How to Use

#### ⚠ Caution

##### ■ Metal One-touch fittings

1. When tightening the hexagon socket head male connector, use a suitable hexagon wrench, and connect the piping carefully so as not to deform or damage the inside of the connector. If the inside of the connector is deformed or damaged, the falling out of tubes may occur.

Hexagon socket head male connector (KQB2S)



2. Uni thread fittings cannot be used. When using Uni thread fittings, the tightening load on the chamfered part of the female thread on the manifold side can cause the female thread side to deform or break.

3. Tighten fittings with the proper tightening torques in the table below.

Connection port	Connection thread size	Proper tightening torque [N·m]
VENT	M5	1 to 1.5
X, PE	G1/8	2.9 to 3.2
2(B), 4(A)	G1/4	5.7 to 6.3
1(P), 3(EB), 5(EA)	G1/2	14.3 to 15.8

##### ■ Manual override

Use a rounded tool (such as a ballpoint hex wrench) for manual override operations. Manipulating manual override with a sharp tool will damage the manual gasket and the IP69K is not satisfied.

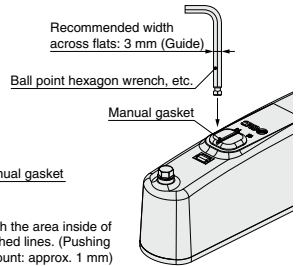

### Valve/Manifold Parts Mounting

#### ⚠ Caution

Mount it so that there is no slippage or deformation in gaskets, and tighten with the tightening torque shown below.

Thread size	Tightening torque	Tightening location
M3	0.8 N·m	Valve, Valve cover, SI unit
M4	1.4 N·m	End block
M6	4.9 N·m	Mounting leg (Option)



# JSY5000-H Series Specific Product Precautions 2

Be sure to read this before handling the products. Refer to page 7 for safety instructions and pages 8 to 14 for 3/4" port solenoid valve precautions.

## Used as a 3-Port Valve

### ⚠ Caution

#### ■ In case of using a 5-port valve as a 3-port valve

The JSY5000 series can be used as normally closed (N.C.) or normally open (N.O.) 3-port valves by closing one of the cylinder ports 4(A) or 2(B) with a plug. However, they should be used with the exhaust ports kept open. Use them when a double solenoid type 3-port valve is required.

Plug position		B port	A port
Type of actuation		N.C.	N.O.
Number of solenoids	Single	(A)4 2(B) 	(A)4 2(B) 
	Double	(A)4 2(B) 	(A)4 2(B) 

## Light/Surge Voltage Suppressor

### ⚠ Caution

#### ■ Polar type

##### Positive common Single solenoid

Light/surge voltage suppressor (□Z)

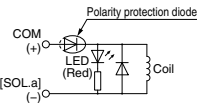

##### Negative common Single solenoid

Light/surge voltage suppressor (□NZ)

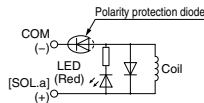

##### Positive common Double solenoid, 3-position, 4-position

Light/surge voltage suppressor (□Z)

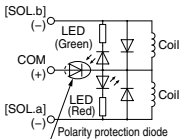

##### Negative common Double solenoid, 3-position, 4-position

Light/surge voltage suppressor (□NZ)

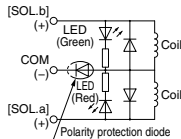

\* Serial transmission type is not applicable for the positive common.

#### ■ Non-polar type

##### With light/surge voltage suppressor (□U)

##### Single solenoid

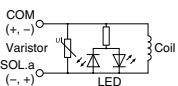

##### Double solenoid

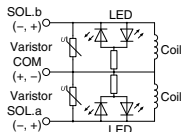

## Light/Surge Voltage Suppressor

### ⚠ Caution

#### ■ With power-saving circuit (Made to order)

Power consumption is decreased to approx. 1/4 compared with the standard product by reducing the wattage required to hold the valve in an energized state. (Effective energizing time is over 67 ms at 24 VDC.)

Electric circuit diagram (With power-saving circuit)  
In the case of single solenoid

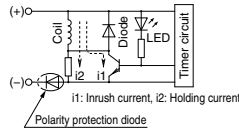

The circuit shown above reduces the power consumption for holding in order to save energy. Refer to the electrical power waveform as shown below.

#### <Electrical power waveform with power-saving circuit>

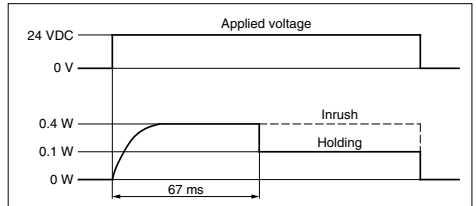

Since the voltage will drop by approx. 0.5 V due to the transistor, pay attention to the allowable voltage fluctuation. (For details, refer to the solenoid specifications of each type of valve.)

#### Residual voltage of the surge voltage suppressor

\* If a varistor or diode surge voltage suppressor is used, there is some residual voltage to the protection element and rated voltage. Therefore, refer to the table below and pay attention to the surge voltage protection on the controller side. Also, since the response time does change, refer to the response time on page 230.

#### Residual Voltage

Surge voltage suppressor	24 VDC
Z	Approx. 1 V
U	Approx. 47 V

## Continuous Duty

### ⚠ Caution

If a valve is energized continuously for long periods of time, the rise in temperature due to heat-up of the coil assembly may cause a decline in solenoid valve performance, reduce service life, or have adverse effects on peripheral equipment. If the valve is energized continuously or if the A side and B side of the dual 3-port valve are energized simultaneously, be sure to use a valve with power-saving circuit.

#### Energization of a 2-Position Double Solenoid Valve

### ⚠ Caution

To avoid operation failure, do not energize the A side and B side of 2-position double solenoid valve at the same time.



# JSY5000-H Series Specific Product Precautions 3

Be sure to read this before handling the products. Refer to page 7 for safety instructions and pages 8 to 14 for 3/4/5 port solenoid valve precautions.

## Countermeasure for Surge Voltage Intrusion

### ⚠ Caution

#### ■ Surge voltage intrusion

With non-polar type valves, at times of sudden interruption of the loading power supply, such as emergency shutdown, surge voltage intrusion may be generated from loading equipment with a large capacity (power consumption), and a valve in a de-energized state may switch over (see Fig. 1).

When installing a breaker circuit for the loading power supply, consider using a valve with polarity (with polarity protection diode), or install a surge absorption diode between the loading equipment COM line and the output equipment COM line (see Fig. 2).

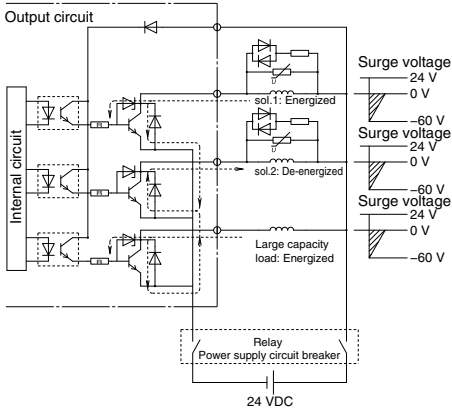

Fig. 1 Surge intrusion circuit example (NPN outlet example) (24 VDC)

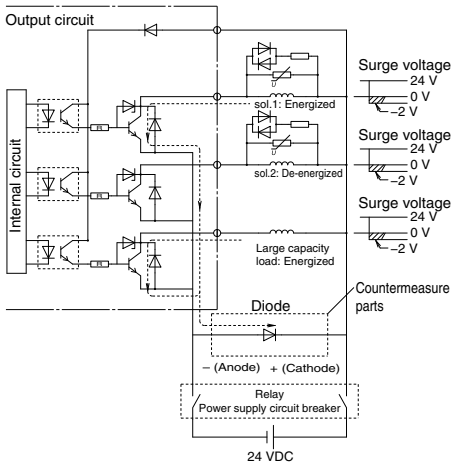
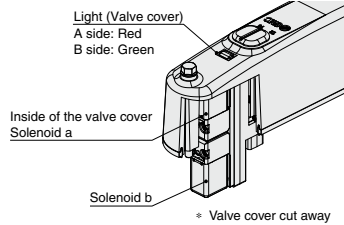

Fig. 2 Surge intrusion countermeasure example (NPN outlet example) (24 VDC)

## Light Indication

### ⚠ Caution

When equipped with indicator light and surge voltage suppressor, the light window turns red when solenoid a is energized, and it turns green when solenoid b is energized.



## Substrate inside Manifolds

### ⚠ Caution

The substrate inside of manifolds cannot be taken apart. Attempting to do so may damage parts.

## Other Tube Brands

### ⚠ Caution

1. When using other than SMC brand tube, confirm that the following specifications are satisfied with respect to the tube outside diameter tolerance.

- 1) Nylon tubing Within  $\pm 0.1$  mm
- 2) Soft nylon tubing Within  $\pm 0.1$  mm
- 3) Polyurethane tubing Within  $+0.15$  mm, Within  $-0.2$  mm

Do not use tubing which does not satisfy the specified tubing O.D. accuracy, or tubing with an I.D., material, hardness, or surface roughness that differs from SMC's tubing. Please consult SMC if anything is unclear. It may cause difficulty in connecting the tubing, leakage, disconnection of the tubing, or fitting damage.

When used with tubing other than those from SMC, due to their properties, the KQG2 and KQB2 are not subject to warranty.

2. When using fittings other than those from SMC, be certain to confirm that the operating conditions are such that no problems will arise.



# JSY5000-H Series

## Specific Product Precautions 4

Be sure to read this before handling the products. Refer to page 7 for safety instructions and pages 8 to 14 for 3/4/5 port solenoid valve precautions.

### One-touch Fittings

#### ⚠ Caution

##### ■ Installation and removal of tubing for One-touch fittings

###### 1) Installation of tubing

- (1) Cut the tubing perpendicularly, being careful not to damage the outside surface. Use an SMC tube cutter TK-1, 2, 3, 5, or 6. Do not cut the tubing with pliers, nippers, scissors, etc., otherwise the tubing will be deformed and problems may result. Allow some extra length in the tube.
- (2) The outside diameter of the polyurethane tubing swells when internal pressure is applied to it. Therefore, it may be impossible to re-insert the tubing into the One-touch fitting. Check the tubing outside diameter, and when the accuracy of the outside diameter is +0.07 mm or larger for  $\phi 2$ , +0.15 mm or larger for other sizes, re-insert it into the One-touch fitting without cutting the tubing. When the tubing is re-inserted into the One-touch fitting, confirm that the tubing goes through the release button smoothly.
- (3) Grasp the tubing, and slowly push it straight (0 to 5°) into the One-touch fitting until it comes to a stop.
- (4) Pull the tubing back gently to make sure it has a positive seal. Insufficient installation may cause air to leak or the tubing to release.

As a guide for checking if the tubing is pulled out or not, refer to the following table.

Tubing size	Tensile force of tubing [N]
$\phi 2$ , $\phi 3.2$ , $\phi 1/8"$	5
$\phi 4$ , $\phi 5/32"$ , $\phi 3/16"$	8
$\phi 6$ , $\phi 1/4"$	12
$\phi 8$ , $\phi 5/16"$	20
$\phi 10$ , $\phi 3/8"$	30
$\phi 12$ , $\phi 1/2"$	35
$\phi 16$	50

###### 2) Removal of tubing

Use the release tool when the removal of tube is difficult due to the tube size. Refer to page 256 for releasing tools.

- (1) Push the release button flange evenly and sufficiently to release the tube. Do not push in the tubing before pressing the release button.
- (2) Pull out the tubing while keeping the release button depressed. If the release button is not held down sufficiently, the tubing cannot be withdrawn.
- (3) To reuse the tubing, remove the previously lodged portion of the tubing. If the lodged portion is left on without being removed, it may result in air leakage and make the removal of the tubing difficult.

### Installation

#### ⚠ Caution

Even though the inlet pressure is within the operating pressure range, when the piping diameter is restricted due to size reduction of supply port 1(P), the flow will be insufficient. In this case, the valve does not switch completely and the cylinder may malfunction.

### Maintenance

#### ⚠ Caution

##### 1. Regular inspection and tightening of the hexagon bolts with flange is recommended at 3 months intervals, to satisfy IP69K. (Recommended inspection interval: 3 months)

For the tightening location and tightening torque, see the exploded view of the manifold (p. 248).

Please replace the washer if it is damaged.

##### 2. When disassembling by removing the hexagon bolt with flange, make sure that there is not moisture on the outer surface of the product. If the product is disassembled or assembled with moisture attached, moisture may enter the inside of the manifold and cause damage.

##### 3. Make sure that the washers are in good condition, in position and assembled when tightening the hexagon bolt with flange.

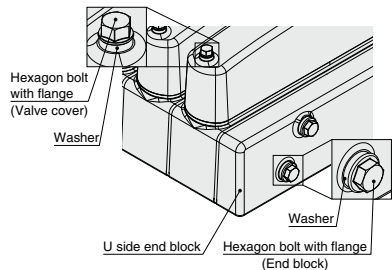



## EX430 Series

# Specific Product Precautions 1

Be sure to read this before handling the products.  
Refer to page 7 for safety instructions.

### Design / Selection

#### Warning

- 1. Do not use beyond the specification range.**  
Using beyond the specification range may result in a fire, malfunction, or damage to the system.  
Check the specifications before operation.
- 2. When using for an interlock circuit:**
  - **Provide a multiple interlock system which is operated by another system (such as a mechanical protection function).**
  - **Perform an inspection to confirm that it is working properly.**  
Failure to do so may result in possible injuries due to malfunction.

#### Caution

- 1. Use within the specified voltage range.**  
Using beyond the specified voltage range is likely to cause product damage or malfunction.
- 2. Do not install in places where it can be used as a foothold.**  
Applying any excessive load such as stepping on the product by mistake or placing a foot on it will cause it to break.
- 3. Keep the surrounding space free for maintenance.**  
When designing a system, take into consideration the amount of free space needed to perform maintenance.
- 4. Beware of inrush currents when the power supply is turned on.**  
Some connected loads can apply an initial charge current which will trigger the over current protection function, causing the product to malfunction.

### Mounting

#### Caution

- 1. When handling and assembling products:**
  - **Do not apply excessive force to the product when disassembling.**  
The connecting parts of the product are firmly joined with seals.
  - **When joining units, take care not to get your fingers caught between the products.**  
Injury may result.
- 2. Do not drop, bump, or apply excessive impact to the product.**  
Doing so may result in damage, equipment failure, or malfunction.

### Mounting

#### Caution

- 3. Observe the tightening torque range.**  
Tightening outside of the allowable torque range will likely damage the screw.  
IP69K cannot be guaranteed if the screws are not tightened to the specified torque.
- 4. When lifting a large solenoid valve manifold, take care to avoid causing stress to the valve connection joint.**  
The connection parts of the product may be damaged.  
Because the product may be heavy, carrying and installation should be performed by more than one operator to avoid strain or injury.
- 5. When installing the product, mount it on a flat surface.**  
Torsion in the whole product may lead to problems such as air leakage or contact failure.

### Wiring

#### Caution

- 1. Avoid repeatedly bending or stretching the cable and applying heavy objects or force to it.**  
Wiring where repeated bending and tensile stress are applied to the cable may result in circuit breakage.
- 2. Avoid miswiring.**  
If miswired, there is a danger of malfunction or damage to the product.
- 3. Do not wire while energizing the product.**  
There is a danger of malfunction or damage to the product or input/output device.
- 4. Avoid wiring the power line and high-voltage line in parallel.**  
Signal line noise or surge from the power line or high-pressure line could cause a malfunction.  
Wiring of the product or input/output device and the power line or high-voltage line should be separated from each other.
- 5. Check the wiring insulation.**  
Defective insulation (contact with other circuits, improper insulation between terminals, etc.) may cause damage to the product or input/output device due to excessive voltage or current.



## EX430 Series

# Specific Product Precautions 2

Be sure to read this before handling the products.  
Refer to page 7 for safety instructions.

### Wiring

#### Caution

6. When the product is installed in machinery/equipment, provide adequate protection against noise by using noise filters, etc.

Noise in signal lines may cause a malfunction.

7. When connecting wires, prevent the entry of water, solvent, or oil from the connector section.

Failure to do so may result in damage, equipment failure, or malfunction.

8. Avoid wiring patterns in which excessive stress is applied to the connector.

Failure to do so may result in equipment failure or malfunction due to contact failure.

### Operating Environment

#### Warning

1. Do not use in atmospheres containing inflammable or explosive gases.

Use in such atmospheres is likely to cause a fire or explosion.  
This product is not explosion proof.

#### Caution

1. Provide adequate protection when operating in locations such as the following.

Failure to do so may cause a malfunction or equipment failure. The effect of countermeasures should be checked in individual equipment and machines.

- 1) Where noise is generated by static electricity, etc.
- 2) Where there is a strong electric field
- 3) Where there is a danger of exposure to radiation
- 4) When in close proximity to power lines or high-voltage lines

2. Do not use in environments where oil and chemicals are used.

Operating in environments where coolants, cleaning solvents, various oils, or chemicals are present may cause adverse effects (damage, malfunction, etc.) to the product even within a short period of time.

3. Do not use in environments where the product could be exposed to corrosive gases or liquids.

Use in such environments may cause product damage or malfunction.

### Operating Environment

#### Caution

4. Select the proper type of enclosure according to the operating environment.

IP69K is achieved when the following conditions are met.

- 1) Provide appropriate wiring using communication cables with M12 connectors.
- 2) Appropriately mount the SI unit and the manifold valve.

5. Do not use in locations with sources of surge generation.

Installation of the product in an area around equipment (electromagnetic lifters, high-frequency induction furnaces, welding machines, motors, etc.) which generates large surge voltages could cause an internal circuitry element of the product to deteriorate or result in damage. Implement countermeasures against the surge from the generating source, and avoid contact between the lines.

6. When directly driving a load which generates a surge voltage by relay, solenoid valve, or lamp, use a load that has an integrated surge-absorption element.

When a surge generating load is directly driven, the product may be damaged.

7. The product is CE/UKCA marked but not immune to lightning strikes. Take measures against lightning strikes in your system.

8. Keep dust, wire scraps, and other foreign matter from entering the product.

Such materials may cause equipment failure or malfunction.

9. Mount the product in a location, which is not affected by vibration or shock.

Failure to do so may cause equipment failure or malfunction.

10. Do not use in direct sunlight.

This may cause equipment failure or malfunction.

11. Use within the ambient temperature range.

Failure to do so may cause a malfunction.

12. Do not use in places where radiated heat may affect the product.

Such places are likely to cause a malfunction.



## EX430 Series

# Specific Product Precautions 3

Be sure to read this before handling the products.  
Refer to page 7 for safety instructions.

### Adjustment / Operation

#### Warning

1. **Do not perform operation or setting with wet hands.**  
There is a risk of electrical shock.

#### Caution

1. **Use a watchmaker's screwdriver with a thin blade for the setting switch.**  
When setting the switch, do not touch any unrelated parts.  
This may cause parts damage or malfunction due to a short circuit.
2. **Perform appropriate setting for the operating conditions.**  
Failure to do so could result in malfunction.  
Refer to the Operation Manual for details on setting each switch.
3. **For details on programming and address setting, refer to the manual from the PLC manufacturer.**  
The programming content related to the protocol is designed by the manufacturer of the PLC used.

### Maintenance

#### Warning

1. **Do not disassemble, modify (including circuit board replacement), or repair this product.**  
Such actions are likely to cause injuries or equipment failure.
2. **When an inspection is performed:**
  - **Turn off the power supply.**
  - **Stop the air supply, exhaust the residual pressure in the piping, and confirm that the air has been released before performing maintenance work.**  
Failure to do so may result in the unexpected malfunction of system components or injury.

#### Caution

1. **When removing from/attaching to the valve manifold:**
  - **Do not apply excessive force to the unit.**  
The connecting parts are firmly joined with seals.
  - **Take care not to get your fingers caught.**  
Injury may result.
2. **Perform periodic inspection.**  
Unexpected malfunction in the system composition devices is likely to occur due to malfunction of machinery or equipment.
3. **After maintenance, make sure to perform an appropriate functionality inspection.**  
When abnormalities such as faulty operation occur, stop operation immediately. Unexpected malfunction in the system composition devices is likely to occur.
4. **Do not use benzine or thinner for cleaning the product.**  
Damage to the surface or erasure of the display may result.  
Wipe off any stains with a soft cloth.  
If the stain is persistent, soak a cloth in a dilute solution of neutral detergent, wring it out sufficiently, wipe the product, and then finish with a dry cloth.

### Other

#### Caution

1. **Refer to the catalog of each series for Common Precautions and Specific Product Precautions for valve manifolds.**