

# 3 Port Solenoid Valve

## VQZ100/200/300 Series

Metal Seal

Rubber Seal



Power consumption: **0.35 w / 0.9 w**  
 (Standard)  
 (High pressure type,  
 High speed response type)

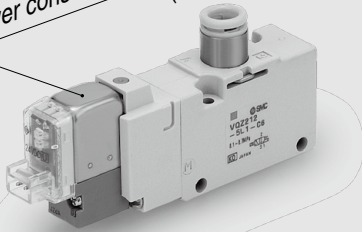

### Compact, High Flow



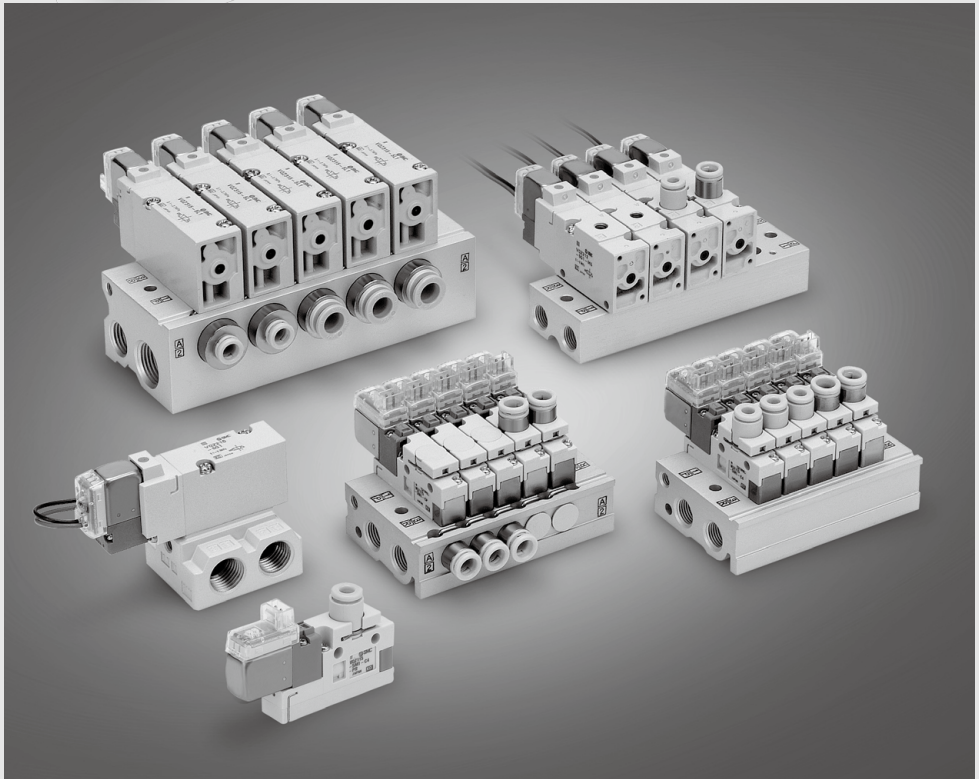









| Series       | Valve width (mm) | Flow rate characteristics                  |   |
|--------------|------------------|--|---|
|              |                  | Metal seal<br>C [dm <sup>3</sup> /(s·bar)] | Rubber seal<br>C [dm <sup>3</sup> /(s·bar)] |
| Body ported  | VQZ100           | —  | 0.56 (Poppet)                               |
|              | VQZ200           | 1.3  | 1.7   |
|              | VQZ300           | 2.4  | 3.0   |
| Base mounted | VQZ100           | —  | 1.0 (Poppet)                                |
|              | VQZ200           | 2.0  | 3.0   |
|              | VQZ300           | 3.2  | 4.1   |



# Metal Seal / Rubber Seal 3 Port Solenoid Valve

## VQZ100/200/300

### Solenoid Valve Variations

|              |        | Sonic conductance C [ $\text{dm}^3/(\text{s}\cdot\text{bar})$ ]   |  | Type of actuation   | Voltage  | Electrical entry  | Light/Surge voltage suppressor      | Manual override                          |
|--------------|--------|---|--|---|--|---|-------------------------------------|--|
| Body ported  | 3 port | VQZ100<br><br>P.1014   | Metal<br>—<br>Rubber<br>(Poppet)<br>0.56 |   |  |   |                                     |  |
|              |        | VQZ200<br><br>P.1015   | 1.3<br>1.7                               |   |  | Grommet (G)<br>  |                                     |  |
|              |        | VQZ300<br><br>P.1015   | 2.4<br>3.0                               | <br>N.C.                     | (Standard)<br>12 VDC<br>24 VDC                       | L-type plug connector (L)<br><br>M-type plug connector (M)<br> | With light/surge voltage suppressor | Non-locking push type<br>(Tool required) |
| Base mounted | 3 port | VQZ100<br><br>P.1030  | Metal<br>—<br>Rubber<br>(Poppet)<br>1.0  | <br>N.O.<br>(Except VQZ100) | (Option)<br>100 VAC<br>200 VAC<br>110 VAC<br>220 VAC | DIN terminal (Y)<br><br>( Except VQZ100 )  |                                     | Locking type<br>(Tool required)          |
|              |        | VQZ200<br><br>P.1031 | 2.0<br>3.0                               |   |  |   |                                     |  |
|              |        | VQZ300<br><br>P.1031 | 3.2<br>4.1                               |   |  |   |                                     |  |

## Manifold

### Body Ported

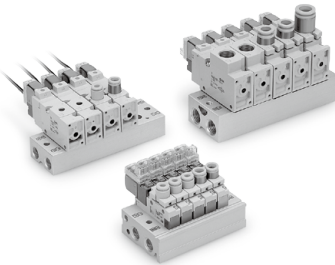

P.1021

| Series | Base model  | Piping direction | Piping specifications |   | Applicable solenoid valve | Applicable stations |
|--------|-------------|------------------|-----------------------|---|---------------------------|---------------------|
|        |             |                  | Bore size             |   |                           |                     |
|        |             |                  | 1(P), 3(R)            | 2(A)  |                           |                     |
| VQZ100 | VV3QZ12-□□□ | Top              | Rc 1/8                | C3 (for ø3.2)<br>C4 (for ø4)<br>C6 (for ø6)<br>M5 (M5 thread) | VQZ115                    | 2 to 20 stations    |
| VQZ200 | VV3QZ22-□□□ | Top              | Rc 1/8                | C4 (for ø4)<br>C6 (for ø6)<br>M5 (M5 thread)                  | VQZ2□2                    | 2 to 20 stations    |
| VQZ300 | VV3QZ32-□□□ | Top              | Rc 1/4                | C6 (for ø6)<br>C8 (for ø8)<br>C10 (for ø10)<br>Rc 1/4         | VQZ3□2                    | 2 to 20 stations    |

### Base Mounted

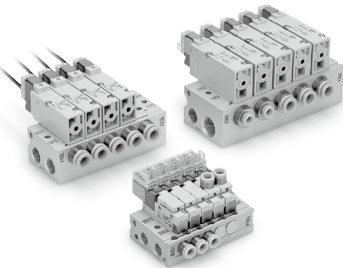

P.1037

| Series | Base model  | Piping direction | Piping specifications                      |   | Applicable solenoid valve | Applicable stations |
|--------|-------------|------------------|--|---|---------------------------|---------------------|
|        |             |                  | Bore size                                  |   |                           |                     |
|        |             |                  | 1(P), 3(R)                                 | 2(A)  |                           |                     |
| VQZ100 | VV3QZ15-□□□ | Side/top         | Rc 1/8                                     | C3 (for ø3.2)<br>C4 (for ø4)<br>C6 (for ø6)<br>M5 (M5 thread) | VQZ115                    | 2 to 20 stations    |
| VQZ200 | VV3QZ25-□□□ | Side             | Rc 1/4                                     | C4 (for ø4)<br>C6 (for ø6)<br>C8 (for ø8)<br>Rc 1/8           | VQZ2□5                    | 2 to 20 stations    |
| VQZ300 | VV3QZ35-□□□ | Side             | 1(P) port<br>Rc 3/8<br>3(R) port<br>Rc 1/4 | C6 (for ø6)<br>C8 (for ø8)<br>C10 (for ø10)<br>Rc 1/4         | VQZ3□5                    | 2 to 20 stations    |

## Manifold Options

### Body Ported

Blanking plate assembly  
VVQZ100-10A-5  
(for VQZ100)  
VVQZ200-10A-2  
(for VQZ200)  
VVQZ300-10A-2  
(for VQZ300)

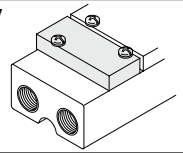

P.1027

### Blanking plug

KQ2P-23  
KQ2P-04  
KQ2P-06  
KQ2P-08  
KQ2P-10

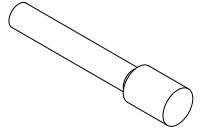

P.1027

### DIN rail

AXT100-DR-□

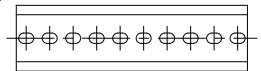

P.1027

### Silencer (for EXH port)

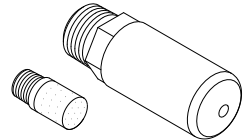

P.1027

### Base Mounted

Blanking plate assembly  
VVQZ100-10A-5  
(for VQZ100)  
VVQZ200-10A-5  
(for VQZ200)  
VVQZ300-10A-5  
(for VQZ300)

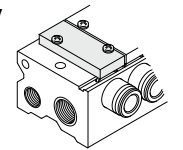

P.1044

### Blanking plug

KQ2P-23  
KQ2P-04  
KQ2P-06  
KQ2P-08  
KQ2P-10

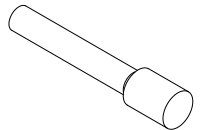

P.1044

### DIN rail

AXT100-DR-□

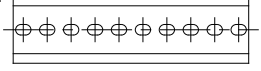

P.1044

### Silencer (for EXH port)

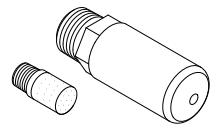

P.1044

Port plug  
VVQZ100-CP (for VQZ100)



P.1044

Body Ported  
Plug Lead Unit

# 3 Port Solenoid Valve

# VQZ100/200/300 Series

## Single Unit



[Option]

Note) CE/UKCA-compliant:DC type only.

### VQZ100 / How to Order Valve

VQZ 1 1 5 [ ] - 5 M [ ] 1 - C6 - PR [ ] - [ ]

Series  
1 VQZ100 body width 10 mm

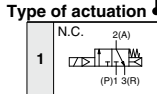

Body type

Function

| Symbol        | Specifications                    | DC       | AC      |
|---------------|-----------------------------------|----------|---------|
| Nil           | Standard                          | (0.35 W) | Note 3) |
| K Note 1)     | High pressure type                | (0.9 W)  | —       |
| R Note 1, 2)  | External pilot type               |          |         |
| KR Note 1, 2) | High pressure/External pilot type | (0.9 W)  | —       |

Note 1) Semi-standard  
Note 2) For details on external pilot type, refer to page 1028.  
Note 3) For AC specification power consumption, refer to page 1016.



**Caution**  
Use standard (DC) specification for continuous duty.

Coil voltage

|                                | CE/UKCA-compliant |
|--------------------------------|-------------------|
| 1 100 VAC (50/60 Hz)           | —                 |
| 2 200 VAC (50/60 Hz)           | —                 |
| 3 110 VAC [115 VAC] (50/60 Hz) | —                 |
| 4 220 VAC [230 VAC] (50/60 Hz) | —                 |
| 5 24 VDC                       | ●                 |
| 6 12 VDC                       | ●                 |

CE/UKCA-compliant

|     |                   |
|-----|-------------------|
| Nil | —                 |
| Q   | CE/UKCA-compliant |

Note) DC type only.

Option

Nil: None  
F: With bracket

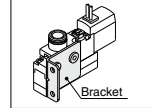

Port size [2(A) port]

|    |                              |
|----|------------------------------|
| C3 | ø3.2 One-touch fitting       |
| C4 | ø4 One-touch fitting         |
| C6 | ø6 One-touch fitting         |
| M5 | M5 thread (Replaceable type) |

Note) For inch size One-touch fittings, refer to page 1028.

Manual override

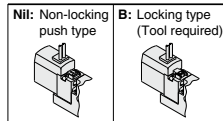

Electrical entry

| G: Grommet (DC specification) | L: L-type plug connector with lead wire | LO: L-type plug connector without connector | M: M-type plug connector with lead wire | MO: M-type plug connector without connector |
|-------------------------------|---|---|---|---|
|                               | With light/surge voltage suppressor     | With light/surge voltage suppressor         | With light/surge voltage suppressor     | With light/surge voltage suppressor         |
|                               |   |   |   |   |

Note) Standard lead wire length: 300 mm

Note) For applicable One-touch fitting and silencer models for this valve series, refer to page 1050.

Note) When placing an order for body ported solenoid valve as a single unit, mounting screw for manifold and gasket are not attached. Order them separately, if necessary. (For details, refer to page 1029.)

## VQZ200/300 / How to Order Valve



Made to Order

(For details, refer to pages 1016 and 1047.)

Note) AC-type models that are CE/UKCA-compliant have DIN terminals only.



# VQZ 2 1 2 - 5 M 1 - C6 - -

### Series

|   |                         |
|---|-------------------------|
| 2 | VQZ200 body width 15 mm |
| 3 | VQZ300 body width 18 mm |

### Type of actuation

|   | N.C. | 2(A) |             |
|---|------|------|-------------|
| 1 |      |      | Metal seal  |
| 2 |      |      | Metal seal  |
| 3 |      |      | Rubber seal |
| 4 |      |      | Rubber seal |

### Body type

|   |             |
|---|-------------|
| 2 | Body ported |
|---|-------------|

### Function

| Symbol               | Specifications   | DC               | AC      |
|----------------------|--|------------------|---------|
| <b>Nil</b>           | Standard   | (0.35 W) Note 3) | Note 3) |
| <b>B</b> Note 1)     | High speed response type                                 | (0.9 W)          | —       |
| <b>K</b> Note 1)     | High pressure type (Metal seal type only)                | (0.9 W)          | —       |
| <b>R</b> Note 1, 2)  | External pilot type                                      | ○                | ○       |
| <b>BR</b> Note 1, 2) | High speed response/External pilot type                  | (0.9 W)          | —       |
| <b>KR</b> Note 1, 2) | High pressure/External pilot type (Metal seal type only) | (0.9 W)          | —       |

Note 1) Semi-standard

Note 2) For details on external pilot type, refer to page 1028.

Note 3) For AC specification power consumption, refer to page 1016.

### ⚠ Caution

Use standard (DC) specification for continuous duty.

### Coil voltage

|   |                              |
|---|------------------------------|
| 1 | 100 VAC (50/60 Hz)           |
| 2 | 200 VAC (50/60 Hz)           |
| 3 | 110 VAC [115 VAC] (50/60 Hz) |
| 4 | 220 VAC [230 VAC] (50/60 Hz) |
| 5 | 24 VDC                       |
| 6 | 12 VDC                       |

Note) For applicable One-touch fitting and silencer models for this valve series, refer to back page 1050.

Note) When placing an order for body ported solenoid valve as a single unit, mounting screw for manifold and gasket are not attached. Order them separately, if necessary. (For details, refer to page 1029.)

### IP65 compliant

|                |           |
|----------------|-----------|
| <b>Nil</b>     | —         |
| <b>W</b> Note) | Compliant |

Note) VQZ200/300 DIN terminal rubber seal only (except external pilot). For details on IP65 enclosure, refer to page 1028.

### CE/UKCA-compliant

|            |                   |
|------------|-------------------|
| <b>Nil</b> | —                 |
| <b>Q</b>   | CE/UKCA-compliant |

Note) AC-type models that are CE/UKCA-compliant have DIN terminals only.

### Option

**Nil:** None  
**F:** With bracket

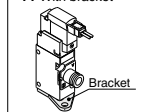

### Port size [2(A) port]

| Symbol     | Port size             | VQZ200 | VQZ300 |
|------------|-----------------------|--------|--------|
| <b>C4</b>  | ø4 One-touch fitting  | ○      | —      |
| <b>C6</b>  | ø6 One-touch fitting  | ○      | ○      |
| <b>C8</b>  | ø8 One-touch fitting  | —      | ○      |
| <b>C10</b> | ø10 One-touch fitting | —      | ○      |
| <b>M5</b>  | M5 thread             | ○      | —      |
| <b>O2</b>  | Rc 1/4                | —      | ○      |

Note) For inch size One-touch fittings and option thread type, refer to page 1028.

### Manual override

**Nil:** Non-locking push type (Tool required)  
**B:** Locking type (Tool required)

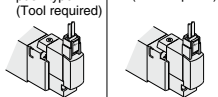

### Electrical entry

|                          | <b>G:</b> Grommet (DC specification) | <b>L:</b> L-type plug connector with lead wire | <b>LO:</b> L-type plug connector without connector | <b>M:</b> M-type plug connector with lead wire | <b>MO:</b> M-type plug connector without connector |
|--------------------------|--------------------------------------|--|--|--|--|
|                          | With light/surge voltage suppressor  | With light/surge voltage suppressor            | With light/surge voltage suppressor                | With light/surge voltage suppressor            | With light/surge voltage suppressor                |
|                          |                                      |  |  |  |  |
| <b>CE/UKCA compliant</b> | AC                                   | —  | —  | —  | —  |
|                          | DC                                   | ●  | ●  | ●  | ●  |
|                          | <b>Y:</b> DIN terminal               | <b>YO:</b> DIN terminal without connector      | <b>YZ:</b> DIN terminal                            | <b>YOS:</b> DIN terminal (Note 2)              | <b>YS:</b> DIN terminal (Note 2)                   |
|                          | With light/surge voltage suppressor  | With light/surge voltage suppressor            | With light/surge voltage suppressor                | With surge voltage suppressor                  | With surge voltage suppressor                      |
|                          |                                      |  |  |  |  |
| <b>CE/UKCA compliant</b> | AC                                   | ●  | ●  | ●  | —  |
|                          | DC                                   | ●  | ●  | ●  | ●  |

Note 1) Standard lead wire length: 300 mm

Note 2) For AC voltage valves there is no "S" type. It is already built-in to the rectifier circuit.

# VQZ100/200/300 Series

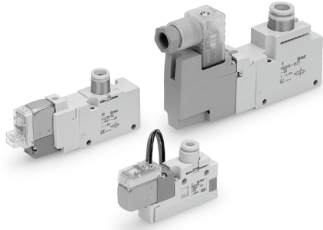

## Specifications

| Valve construction   | Metal seal   | Rubber seal | Poppet seal (VQZ100)              |
|--|--|-------------|-----------------------------------|
| Fluid  | Air  |             |                                   |
| Max. operating pressure (MPa)                                      | 0.7 (High pressure type: 1.0)                      | 0.7         | 0.7 (High pressure type: 1.0)     |
| Min. operating pressure (MPa)                                      | 0.1  | 0.15        | 0.15                              |
| Ambient and fluid temperature (°C)                                 | -10 to 50 (No freezing)                            |             |                                   |
| Max. operating frequency (Hz)                                      | 20   | 5           | 20                                |
| Pilot exhaust method   | Individual exhaust                                 |             | Common exhaust <sup>Note 1)</sup> |
| Lubrication  | Not required                                       |             |                                   |
| Manual override  | Push type, Locking type (Tool required)            |             |                                   |
| Mounting orientation   | Free   |             |                                   |
| Impact/Vibration resistance (m/s <sup>2</sup> ) <sup>Note 2)</sup> | 150/30   |             |                                   |
| Enclosure*   | Dustproof (DIN terminal: IP65 <sup>Note 3)</sup> ) |             |                                   |

\* Based on IEC60529

Note 1) When using body ported type as a single unit, the individual exhaust is used.

Note 2) Impact resistance: No malfunction occurred when it is tested with a drop tester in the axial direction and at the right angles to the main valve and armature in both energized and de-energized states every once for each condition. (Value in the initial state)

Vibration resistance: No malfunction occurred in one sweep test between 45 and 2000 Hz. Test was performed to axis and right angle directions of the main valve and armature when pilot signal is ON and OFF. (Value in the initial state)

Note 3) When IP65 compliant DIN terminals are selected: VQZ□□□□□□□□□□□□□□□□

## Solenoid Specifications

### Semi-standard Specifications

|   |
|---|
| High speed response type                  |
| High pressure type (Metal seal type only) |
| External pilot type*                      |

\* For details on external pilot type, refer to page 1028.

**Made to Order**  
(For details, refer to page 1047.)

| Symbol | Description                |
|--------|----------------------------|
| X30    | Pilot valve common exhaust |
| X90    | Main valve fluororubber    |
| X113   | All fluororubber           |

| Electrical entry              |                         | Grommet (G)                                |   | M-type plug connector (M) |  |
|-------------------------------|-------------------------|--|---|---------------------------|--|
|                               |                         | L-type plug connector (L)                  |   | DIN terminal (Y)          |  |
|                               |                         | G, L, M                                    |   | Y                         |  |
| Coil rated voltage (V)        | DC                      | 24, 12                                     |   |                           |  |
|                               | AC 50/60 Hz             | 100, 110, 200, 220*                        |   |                           |  |
| Allowable voltage fluctuation |                         | ±10% of rated voltage*                     |   |                           |  |
| Power consumption (W)         | DC                      | Standard                                   | 0.35 [(With light: 0.4 (DIN terminal with light: 0.45)] |                           |  |
|                               |                         | High speed response, high pressure         | 0.9 [(With light: 0.95 (DIN terminal with light: 1.0)]  |                           |  |
|                               |                         | 100 V                                      | 0.78 (With light: 0.81)                                 | 0.78 (With light: 0.87)   |  |
| Apparent power (VA)*          | AC                      | 110 V                                      | 0.86 (With light: 0.89)                                 | 0.86 (With light: 0.87)   |  |
|                               |                         | [115 V]                                    | 0.94 (With light: 0.97)                                 | 0.94 (With light: 1.07)   |  |
|                               |                         | 200 V                                      | 1.18 (With light: 1.22)                                 | 1.15 (With light: 1.30)   |  |
|                               |                         | 220 V                                      | 1.30 (With light: 1.34)                                 | 1.27 (With light: 1.46)   |  |
| [230 V]                       | 1.42 (With light: 1.46) | 1.39 (With light: 1.60)                    |   |                           |  |
| Surge voltage suppressor      |                         | Varistor                                   |   |                           |  |
| Indicator light               |                         | LED (Neon light when AC with DIN terminal) |   |                           |  |

\* In common between 110 VAC and 115 VAC, and between 220 VAC and 230 VAC.

\* For 115 VAC and 230 VAC, the allowable voltage is -15% to +5% of rated voltage.

### Flow Rate Characteristics

| Series | Type of actuation | Model       | Flow rate characteristics    |      |      |                              |      |      | Response time (ms) <sup>Note 1)</sup> |                            |                      |            | Weight (g) |    |
|--------|-------------------|-------------|------------------------------|------|------|------------------------------|------|------|---------------------------------------|----------------------------|----------------------|------------|------------|----|
|        |                   |             | 1 → 2 (P → A)                |      |      | 2 → 3 (A → R)                |      |      | Standard: 0.35 W                      | High speed response: 0.9 W | High pressure: 0.9 W | AC         |            |    |
|        |                   |             | C [dm <sup>3</sup> /(s·bar)] | b    | Cv   | C [dm <sup>3</sup> /(s·bar)] | b    | Cv   |                                       |                            |                      |            |            |    |
| VQZ100 | N.C. valve        | Poppet      | VQZ115                       | 0.59 | 0.44 | 0.17                         | 0.56 | 0.30 | 0.14                                  | 10 or less                 | —                    | 13 or less | 22 or less | 24 |
| VQZ200 | N.C. valve        | Metal seal  | VQZ212                       | 1.2  | 0.21 | 0.30                         | 1.3  | 0.24 | 0.33                                  | 22 or less                 | 14 or less           | 18 or less | 34 or less | 57 |
|        |                   | Rubber seal | VQZ232                       | 1.6  | 0.33 | 0.39                         | 1.7  | 0.37 | 0.45                                  | 22 or less                 | 15 or less           | —          | 36 or less |    |
|        | N.O. valve        | Metal seal  | VQZ222                       | 1.2  | 0.25 | 0.31                         | 1.3  | 0.20 | 0.31                                  | 22 or less                 | 14 or less           | 18 or less | 34 or less |    |
|        |                   | Rubber seal | VQZ242                       | 1.6  | 0.36 | 0.40                         | 1.7  | 0.36 | 0.45                                  | 22 or less                 | 15 or less           | —          | 36 or less |    |
| VQZ300 | N.C. valve        | Metal seal  | VQZ312                       | 2.7  | 0.18 | 0.62                         | 2.4  | 0.28 | 0.56                                  | 22 or less                 | 17 or less           | 22 or less | 34 or less | 93 |
|        |                   | Rubber seal | VQZ332                       | 3.5  | 0.34 | 0.87                         | 3.0  | 0.33 | 0.72                                  | 33 or less                 | 25 or less           | —          | 57 or less |    |
|        | N.O. valve        | Metal seal  | VQZ322                       | 2.6  | 0.21 | 0.59                         | 2.2  | 0.16 | 0.49                                  | 22 or less                 | 17 or less           | 22 or less | 34 or less |    |
|        |                   | Rubber seal | VQZ342                       | 3.5  | 0.38 | 0.88                         | 2.9  | 0.27 | 0.69                                  | 33 or less                 | 25 or less           | —          | 57 or less |    |

Note 1) Based on JIS B 8419: 2010 (Supply pressure: 0.5 MPa; with light/surge voltage suppressor: clean air)

Response time values will change depending on pressure and air quality.

Note 2) Weight for threaded connection

1016



## Construction

### VQZ100 Poppet type

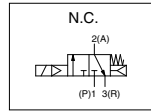
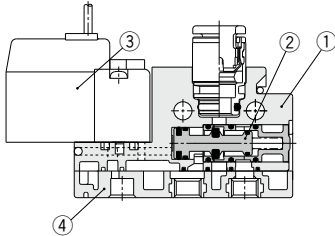

### Component Parts

| No. | Description          | Material       | Note   |
|-----|----------------------|----------------|--|
| 1   | Body                 | Resin          |  |
| 2   | Spool valve          | Aluminum/HNBR  |  |
| 3   | Pilot valve assembly | —              |  |
| 4   | P. R. plate          | Resin/Aluminum | VQZ100-12A (Standard)<br>VQZ100-12B (External pilot type) <sup>Note)</sup> |

Note) It is not possible to change the standard product to external pilot type, and vice versa.

### VQZ200/300 Metal seal type

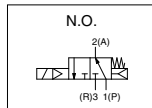
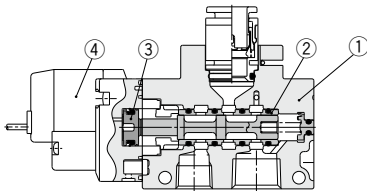
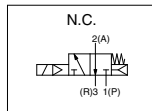
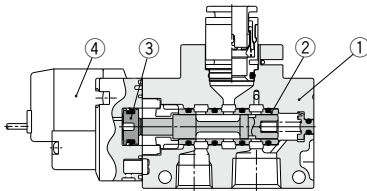

### Rubber seal type

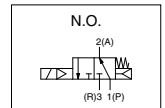
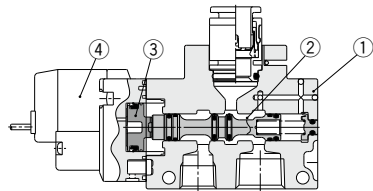
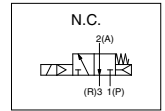
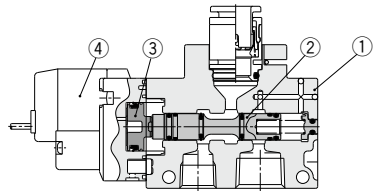

### Component Parts

| No. | Description          | Material            | Note        |
|-----|----------------------|---------------------|-------------|
| 1   | Body                 | Aluminum die-casted |             |
| 2   | Spool, Sleeve        | Stainless steel     | Metal seal  |
|     | Spool valve          | Aluminum/HNBR       | Rubber seal |
| 3   | Piston               | Resin               |             |
| 4   | Pilot valve assembly | —                   |             |

Note) For "How to Order Pilot Valve Assembly", refer to page 1029.

# VQZ100/200/300 Series

## Dimensions: VQZ100

### Single Unit

Grommet (G): VQZ115□-□G□1-C3, C4, C6-PR

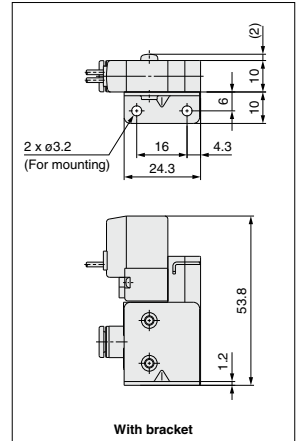
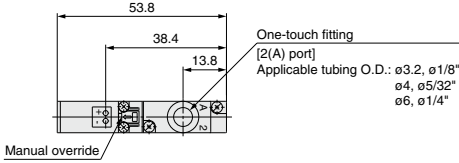

Note) For bracket assembly part no., refer to page 1029.

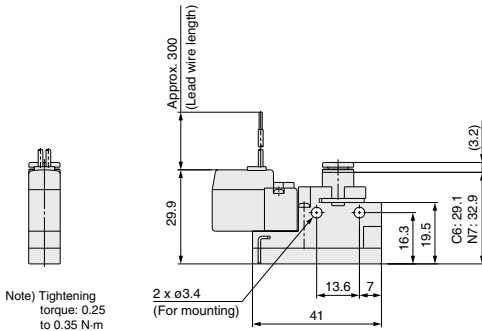

Note) Tightening torque: 0.25 to 0.35 N·m

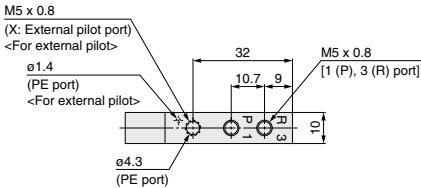

Note) For One-touch fittings for P/R port and silencer part no., refer to page 1050.

### VQZ115□-□G□1-M5-PR

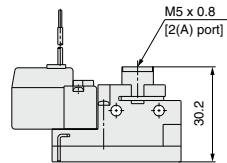

### L-type plug connector (L): VQZ115□-□L□1-C3, C4, C6-PR

### M-type plug connector (M): VQZ115□-□M□1-C3, C4, C6-PR

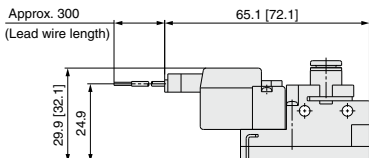

Unless otherwise indicated, dimensions are the same as Grommet (G).  
[ ]: AC

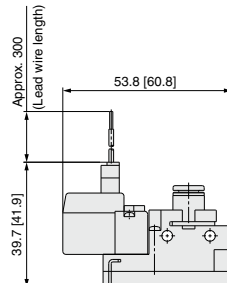

Unless otherwise indicated, dimensions are the same as Grommet (G).  
[ ]: AC



## Dimensions: VQZ200

### Single Unit

#### Grommet (G): VQZ2□□-□G□1-C4, C6

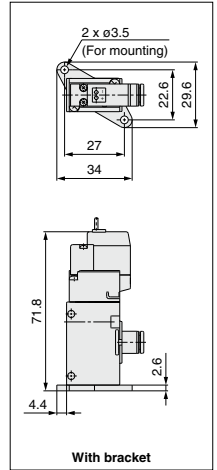
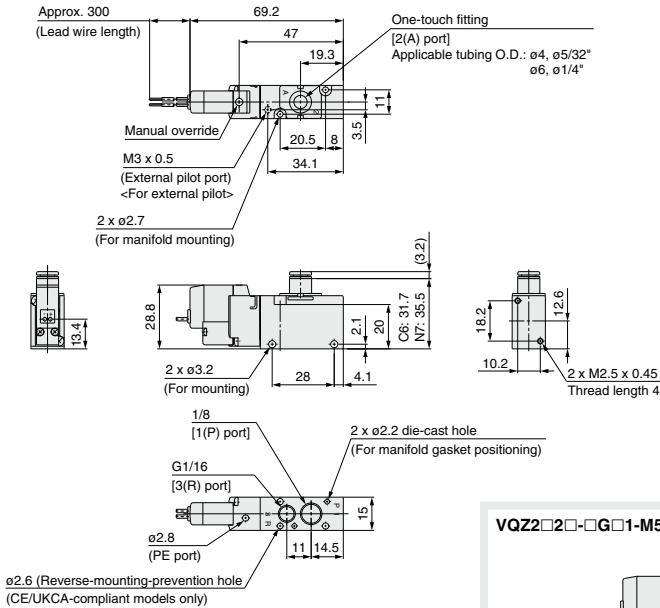

Note) For bracket assembly part no., refer to page 1029.

Note) For One-touch fittings for P/R port and silencer part no., refer to page 1050.

#### VQZ2□□-□G□1-M5

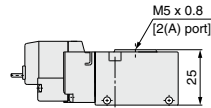

#### L-type plug connector (L): VQZ2□□-□L□1-C4, C6

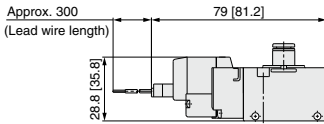

Unless otherwise indicated, dimensions are the same as Grommet (G).  
[ ]: AC

#### M-type plug connector (M): VQZ2□□-□M□1-C4, C6

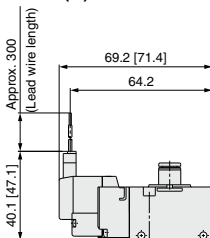

Unless otherwise indicated, dimensions are the same as Grommet (G).  
[ ]: AC

#### DIN terminal (Y): VQZ2□□-□Y□□1-C4, C6

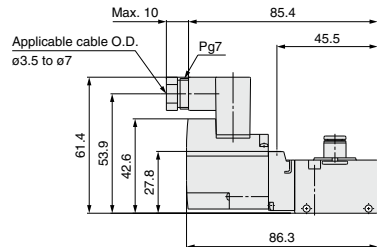

Unless otherwise indicated, dimensions are the same as Grommet (G).

# VQZ100/200/300 Series

## Dimensions: VQZ300

### Single Unit

#### Grommet (G): VQZ3□2□-□G□1-C6, C8, C10

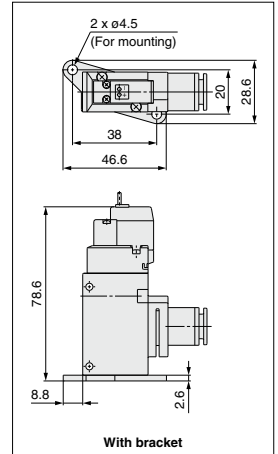
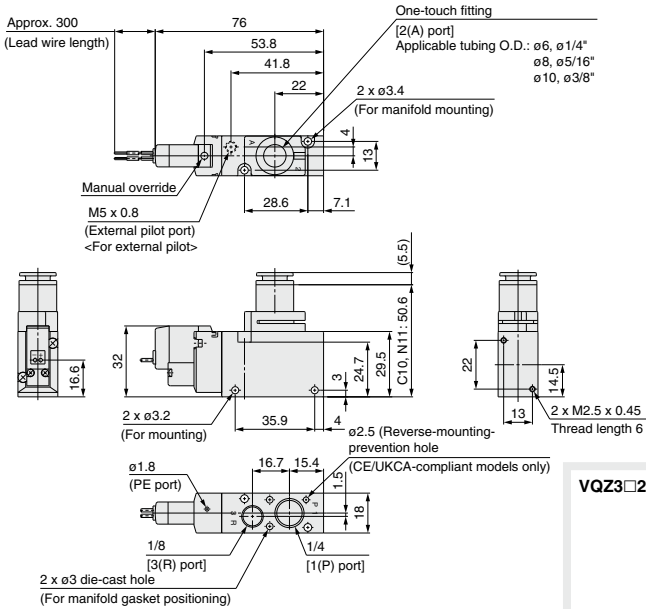

Note) For bracket assembly part no., refer to page 1029.

#### VQZ3□2□-□G□1-02

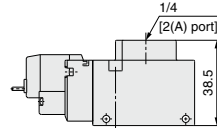

#### L-type plug connector (L): VQZ3□2□-□L□1-C6, C8, C10

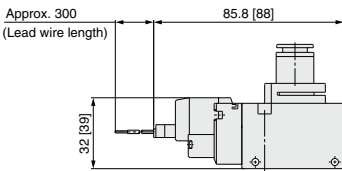

Unless otherwise indicated, dimensions are the same as Grommet (G).  
[ ] : AC

#### DIN terminal (Y): VQZ3□2□-□Y□1-C6, C8, C10

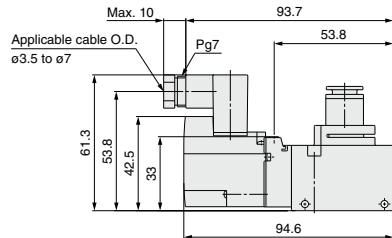

Unless otherwise indicated, dimensions are the same as Grommet (G).

#### M-type plug connector (M): VQZ3□2□-□M□1-C6, C8, C10

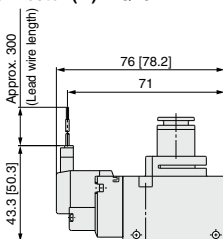

Unless otherwise indicated, dimensions are the same as Grommet (G).  
[ ] : AC

Body Ported  
Plug Lead Unit

# 3 Port Solenoid Valve

## VQZ100/200/300 Series

### Manifold Connector Kit



[Option]

Note) For CE/UKCA-compliant models, DC type only.

### VQZ100 / How to Order Manifold

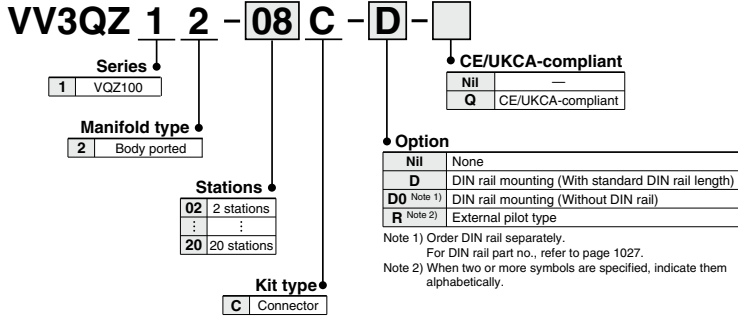

Note) For 1(P), 3(R) of optional thread type, refer to page 1028.

### VQZ100 / How to Order Valve

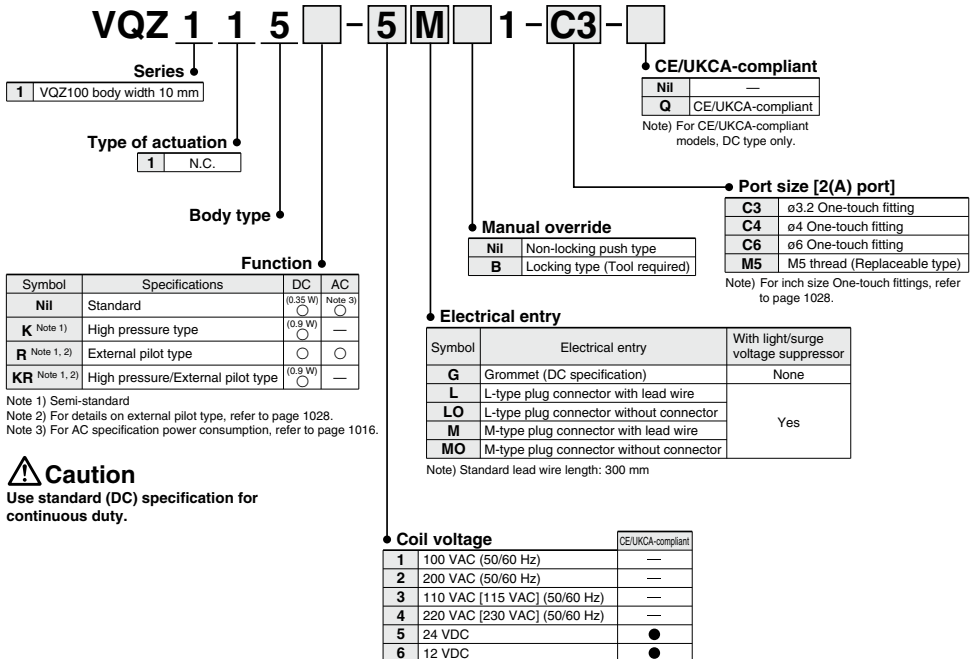

**Caution**  
Use standard (DC) specification for continuous duty.

# VQZ100/200/300 Series

## VQZ200/300 / How to Order Manifold



**Made to Order**  
(For details, refer to page 1047.)

Note) AC-type models that are CE/UKCA-compliant have DIN terminals only.



VV3QZ **2** **2** - **08** **C** - [ ] - [ ]

**Series**

|   |        |
|---|--------|
| 2 | VQZ200 |
| 3 | VQZ300 |

**Manifold type**

|   |             |
|---|-------------|
| 2 | Body ported |
|---|-------------|

**Stations**

|    |             |
|----|-------------|
| 02 | 2 stations  |
| :  | :           |
| 20 | 20 stations |

**CE/UKCA-compliant**

|     |                   |
|-----|-------------------|
| Nil | —                 |
| Q   | CE/UKCA-compliant |

**Option**

|                     |   |
|---------------------|---|
| Nil                 | None  |
| D                   | DIN rail mounting (With standard DIN rail length) |
| D0 <sup>Note)</sup> | DIN rail mounting (Without DIN rail)              |

Note) Order DIN rail separately.  
For DIN rail part no., refer to page 1027.

**Kit type**

|   |           |
|---|-----------|
| C | Connector |
|---|-----------|

Note) For 1(P), 3(R) of optional thread type, refer to page 1028.

## VQZ200/300 / How to Order Valve

VQZ **2** **1** **2** [ ] - **5** **M** [ ] [ ] **1** - [ ] - [ ]

**Series**

|   |                         |
|---|-------------------------|
| 2 | VQZ200 body width 15 mm |
| 3 | VQZ300 body width 18 mm |

**Type of actuation**

|   |                  |
|---|------------------|
| 1 | N.C. Metal seal  |
| 2 | N.O. Metal seal  |
| 3 | N.C. Rubber seal |
| 4 | N.O. Rubber seal |

**Body type**

|   |             |
|---|-------------|
| 2 | Body ported |
|---|-------------|

**Function**

| Symbol                   | Specifications   | DC<br>(0.35 W)        | AC<br>(Note 3)        |
|--------------------------|--|-----------------------|-----------------------|
| Nil                      | Standard   | <input type="radio"/> | <input type="radio"/> |
| B <sup>Note 1)</sup>     | High speed response type                                 | <input type="radio"/> | —                     |
| K <sup>Note 1)</sup>     | High pressure type (Metal seal type only)                | <input type="radio"/> | —                     |
| R <sup>Note 1, 2)</sup>  | External pilot type                                      | <input type="radio"/> | <input type="radio"/> |
| BR <sup>Note 1, 2)</sup> | High speed response/External pilot type                  | <input type="radio"/> | —                     |
| KR <sup>Note 1, 2)</sup> | High pressure/External pilot type (Metal seal type only) | <input type="radio"/> | —                     |

Note 1) Semi-standard  
Note 2) For details on external pilot type, refer to page 1028.  
Note 3) For AC specification power consumption, refer to page 1016.



**Caution**  
Use standard (DC) specification for continuous duty.

**Coil voltage**

|   |                              |
|---|------------------------------|
| 1 | 100 VAC (50/60 Hz)           |
| 2 | 200 VAC (50/60 Hz)           |
| 3 | 110 VAC [115 VAC] (50/60 Hz) |
| 4 | 220 VAC [230 VAC] (50/60 Hz) |
| 5 | 24 VDC                       |
| 6 | 12 VDC                       |

**IP65 compliant**

|                    |           |
|--------------------|-----------|
| Nil                | —         |
| W <sup>Note)</sup> | Compliant |

Note) VQZ200/300 DIN terminal rubber seal only (except external pilot). For details on IP65 enclosure, refer to page 1028.

**CE/UKCA-compliant**

|     |                   |
|-----|-------------------|
| Nil | —                 |
| Q   | CE/UKCA-compliant |

Note) AC-type models that are CE/UKCA-compliant have DIN terminals only.

**Port size [2(A) port]**

| Symbol | Port size             | VQZ200                | VQZ300                |
|--------|-----------------------|-----------------------|-----------------------|
| C4     | ø4 One-touch fitting  | <input type="radio"/> | —                     |
| C6     | ø6 One-touch fitting  | <input type="radio"/> | <input type="radio"/> |
| C8     | ø8 One-touch fitting  | —                     | <input type="radio"/> |
| C10    | ø10 One-touch fitting | —                     | <input type="radio"/> |
| M5     | M5 thread             | <input type="radio"/> | —                     |
| O2     | Rc 1/4                | —                     | <input type="radio"/> |

Note) For inch size One-touch fittings and optional thread type, refer to page 1028.

**Manual override**

|     |                                       |
|-----|---------------------------------------|
| Nil | Non-locking push type (Tool required) |
| B   | Locking type (Tool required)          |

**Electrical entry**

| Symbol                 | Electrical entry                                  | Light/surge voltage suppressor | CE/UKCA-compliant |    |
|------------------------|---|--------------------------------|-------------------|----|
|                        |   |                                | AC                | DC |
| G                      | Grommet (DC specification)                        | None                           | —                 | ●  |
| L                      | L-type plug connector with lead wire              | Yes                            | —                 | ●  |
| LO                     | L-type plug connector without connector           |                                | —                 | ●  |
| M                      | M-type plug connector with lead wire              |                                | —                 | ●  |
| MO                     | M-type plug connector without connector           | —                              | ●                 |    |
| Y                      | DIN terminal                                      | None                           | ●                 | ●  |
| YO                     | DIN terminal without connector                    |                                | ●                 | ●  |
| YZ                     | DIN terminal                                      | Yes                            | ●                 | ●  |
| YS <sup>Note 2)</sup>  | DIN terminal (DC specification)                   | Yes (Without light)            | —                 | ●  |
| YOS <sup>Note 2)</sup> | DIN terminal without connector (DC specification) |                                | —                 | ●  |

Note 1) Standard lead wire length: 300 mm  
Note 2) For AC voltage valves there is no "S" type. It is already built-in to the rectifier circuit.

Note) When placing an order for body ported solenoid valve as a single unit, mounting screw for manifold and gasket are not attached. Order them separately, if necessary. (For details, refer to page 1029.)

## Manifold Specifications

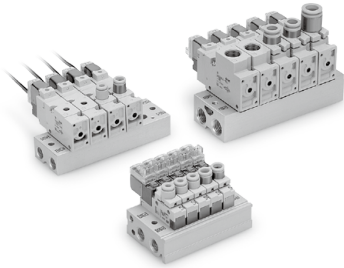

| Series        | Base model         | Piping specifications |            |   | Applicable solenoid valve | Applicable stations | Manifold base weight (g)                    |
|---------------|--------------------|-----------------------|------------|---|---------------------------|---------------------|---|
|               |                    | Piping direction      | Port size  |   |                           |                     |   |
|               |                    |                       | 1(P), 3(R) | 2(A)  |                           |                     |   |
| <b>VQZ100</b> | <b>VV3QZ12-□□□</b> | Top                   | Rc 1/8     | C3 (for ø3.2)<br>C4 (for ø4)<br>C6 (for ø6)<br>M5 (M5 thread) | <b>VQZ115</b>             | 2 to 20 stations    | 2 stations: 83<br>Addition per station: 19  |
| <b>VQZ200</b> | <b>VV3QZ22-□□□</b> | Top                   | Rc 1/8     | C4 (for ø4)<br>C6 (for ø6)<br>M5 (M5 thread)                  | <b>VQZ2□2</b>             | 2 to 20 stations    | 2 stations: 68<br>Addition per station: 20  |
| <b>VQZ300</b> | <b>VV3QZ32-□□□</b> | Top                   | Rc 1/4     | C6 (for ø6)<br>C8 (for ø8)<br>C10 (for ø10)<br>Rc 1/4         | <b>VQZ3□2</b>             | 2 to 20 stations    | 2 stations: 114<br>Addition per station: 37 |

## How to Order Manifold Assembly (Example)

**VV3QZ22-05C** ..... 1 set (C kit 5-station manifold base part no.)  
 \* **VVQZ200-10A-2** ... 1 set (Blanking plate assembly part no.)  
 \* **VQZ212-5M1-C6** ... 4 sets (N.C. type part no.)

→ The asterisk denotes the symbol for assembly. Prefix it to the part nos. of the solenoid valve, etc.  
 → Enter in order starting from the first station on the D side.

Add the valve and option part number under the manifold base part number.  
 When entry of part numbers becomes complicated, indicate by the manifold specification sheet.

# VQZ100/200/300 Series

## Dimensions: VQZ100

### VV3QZ12- Stations C

#### Grommet (G)

[ U side

[ D side

One-touch fitting

[2(A) port]

Applicable tubing O.D.:  $\phi 3.2$ ,  $\phi 1/8"$

$\phi 4$ ,  $\phi 5/32"$

$\phi 6$ ,  $\phi 1/4"$

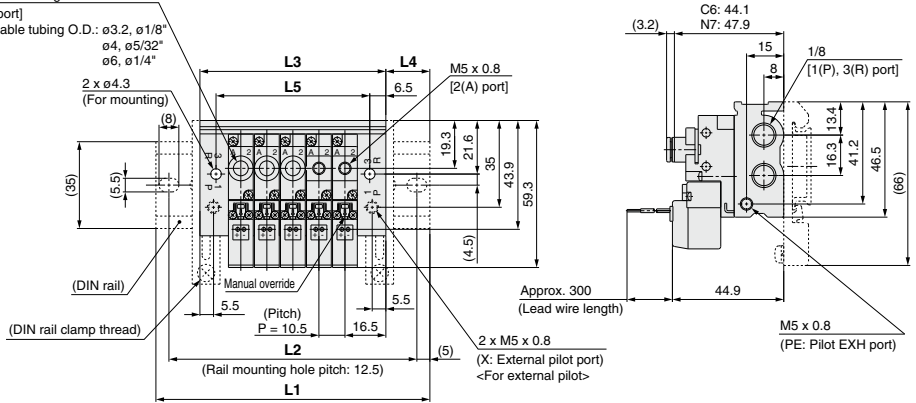

(Station n) ----- (Station 1)

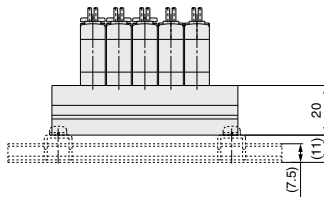

The dashed lines indicate the DIN rail mounting [-D].

#### M5

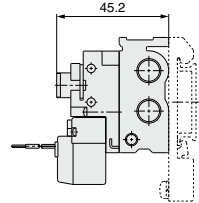

#### L-type plug connector (L)

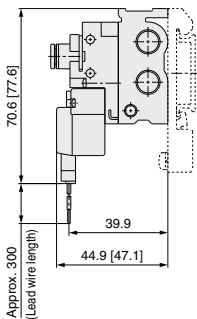

Unless otherwise indicated, dimensions are the same as Grommet (G).

[ ] : AC

#### M-type plug connector (M)

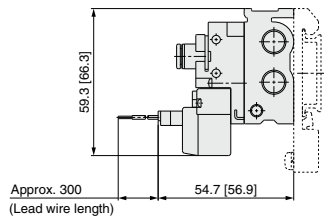

Unless otherwise indicated, dimensions are the same as Grommet (G).

[ ] : AC

#### Dimensions

n: Stations (Max. 20 stations)

| n  | 2    | 3    | 4    | 5     | 6     | 7     | 8     | 9     | 10    | 11    | 12    | 13    | 14    | 15    | 16    | 17    | 18    | 19    | 20    |
|----|------|------|------|-------|-------|-------|-------|-------|-------|-------|-------|-------|-------|-------|-------|-------|-------|-------|-------|
| L1 | 85.5 | 85.5 | 98   | 110.5 | 123   | 135.5 | 148   | 148   | 160.5 | 173   | 185.5 | 198   | 210.5 | 210.5 | 223   | 235.5 | 248   | 260.5 | 273   |
| L2 | 75   | 75   | 87.5 | 100   | 112.5 | 125   | 137.5 | 137.5 | 150   | 162.5 | 175   | 187.5 | 200   | 200   | 212.5 | 225   | 237.5 | 250   | 262.5 |
| L3 | 43.5 | 54   | 64.5 | 75    | 85.5  | 96    | 106.5 | 117   | 127.5 | 138   | 148.5 | 159   | 169.5 | 180   | 190.5 | 201   | 211.5 | 222   | 232.5 |
| L4 | 21   | 16   | 17   | 18    | 19    | 20    | 21    | 15.5  | 16.5  | 17.5  | 18.5  | 19.5  | 20.5  | 15.5  | 16.5  | 17.5  | 18.5  | 19.5  | 20.5  |
| L5 | 30.5 | 41   | 51.5 | 62    | 72.5  | 83    | 93.5  | 104   | 114.5 | 125   | 135.5 | 146   | 156.5 | 167   | 177.5 | 188   | 198.5 | 209   | 219.5 |

## Dimensions: VQZ200

### VV3QZ22- Stations C

#### Grommet (G)

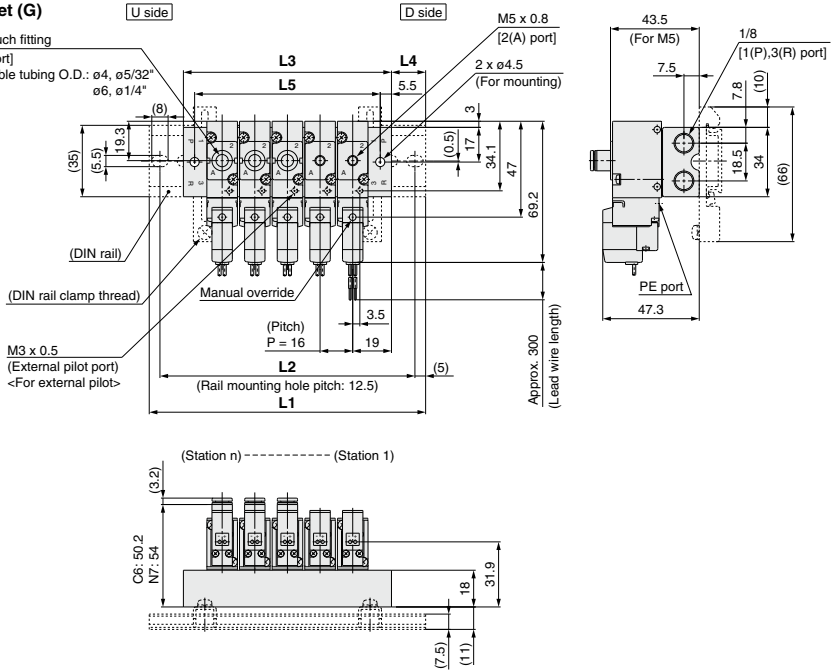

The dashed lines indicate the DIN rail mounting [-D].

#### L-type plug connector (L)

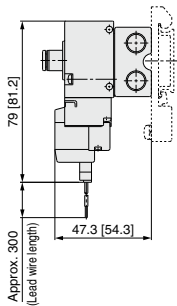

Unless otherwise indicated, dimensions are the same as Grommet (G).  
[ ] : AC

#### M-type plug connector (M)

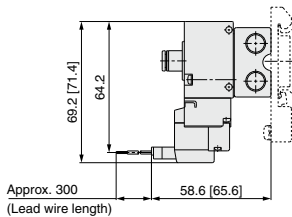

Unless otherwise indicated, dimensions are the same as Grommet (G).  
[ ] : AC

#### DIN terminal (Y)

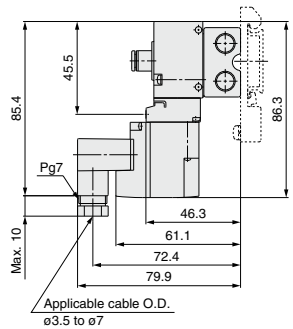

Unless otherwise indicated, dimensions are the same as Grommet (G).

#### Dimensions

| n  | 2    | 3     | 4     | 5     | 6     | 7     | 8     | 9     | 10    | 11    | 12    | 13    | 14    | 15    | 16    | 17    | 18    | 19    | 20    |
|----|------|-------|-------|-------|-------|-------|-------|-------|-------|-------|-------|-------|-------|-------|-------|-------|-------|-------|-------|
| L1 | 85.5 | 110.5 | 123   | 135.5 | 148   | 173   | 185.5 | 198   | 223   | 235.5 | 248   | 260.5 | 285.5 | 298   | 310.5 | 335.5 | 348   | 360.5 | 373   |
| L2 | 75   | 100   | 112.5 | 125   | 137.5 | 162.5 | 175   | 187.5 | 212.5 | 225   | 237.5 | 250   | 275   | 287.5 | 300   | 325   | 337.5 | 350   | 362.5 |
| L3 | 54   | 70    | 86    | 102   | 118   | 134   | 150   | 166   | 182   | 198   | 214   | 230   | 246   | 262   | 278   | 294   | 310   | 326   | 342   |
| L4 | 16   | 20.5  | 18.5  | 17    | 15    | 19.5  | 18    | 16    | 20.5  | 19    | 17    | 15.5  | 20    | 18    | 16.5  | 21    | 19    | 17.5  | 15.5  |
| L5 | 43   | 59    | 75    | 91    | 107   | 123   | 139   | 155   | 171   | 187   | 203   | 219   | 235   | 251   | 267   | 283   | 299   | 315   | 331   |

n: Stations (Max. 20 stations)

# VQZ100/200/300 Series

## Dimensions: VQZ300

### VV3QZ32- Stations C

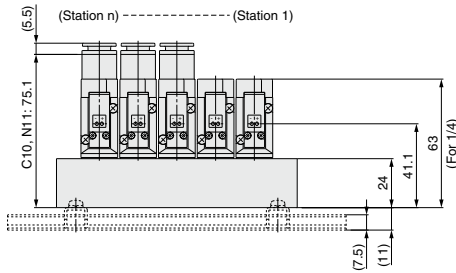
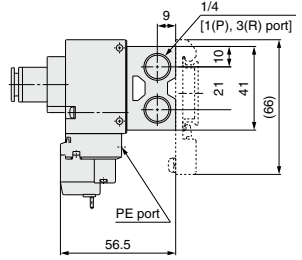
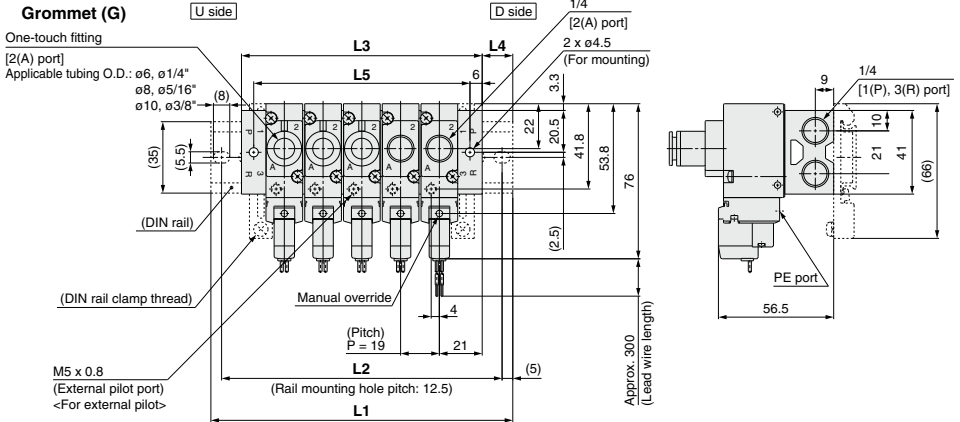

The dashed lines indicate the DIN rail mounting [-D].

### L-type plug connector (L)

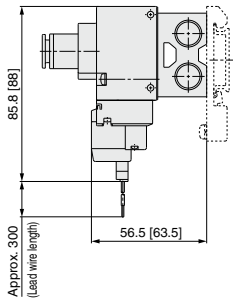

Unless otherwise indicated, dimensions are the same as Grommet (G).  
[ ]: AC

### M-type plug connector (M)

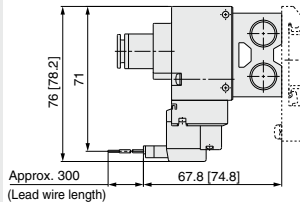

Unless otherwise indicated, dimensions are the same as Grommet (G).  
[ ]: AC

### DIN terminal (Y)

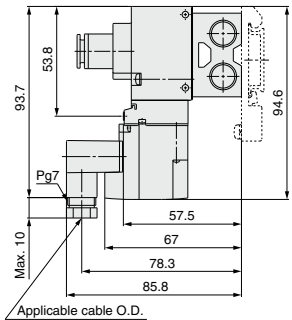

Unless otherwise indicated, dimensions are the same as Grommet (G).

### Dimensions

| n  | n: Stations (Max. 20 stations) |       |       |       |       |       |       |       |       |       |       |       |       |       |       |       |       |       |       |  |
|----|--------------------------------|-------|-------|-------|-------|-------|-------|-------|-------|-------|-------|-------|-------|-------|-------|-------|-------|-------|-------|--|
|    | 2                              | 3     | 4     | 5     | 6     | 7     | 8     | 9     | 10    | 11    | 12    | 13    | 14    | 15    | 16    | 17    | 18    | 19    | 20    |  |
| L1 | 98                             | 110.5 | 135.5 | 148   | 173   | 198   | 210.5 | 235.5 | 248   | 273   | 285.5 | 310.5 | 323   | 348   | 360.5 | 385.5 | 398   | 423   | 435.5 |  |
| L2 | 87.5                           | 100   | 125   | 137.5 | 162.5 | 187.5 | 200   | 225   | 237.5 | 262.5 | 275   | 300   | 312.5 | 337.5 | 350   | 375   | 387.5 | 412.5 | 425   |  |
| L3 | 61                             | 80    | 99    | 118   | 137   | 156   | 175   | 194   | 213   | 232   | 251   | 270   | 289   | 308   | 327   | 346   | 365   | 384   | 403   |  |
| L4 | 18.5                           | 15.5  | 18.5  | 15    | 18    | 21    | 18    | 21    | 17.5  | 20.5  | 17.5  | 20.5  | 17    | 20    | 17    | 20    | 16.5  | 19.5  | 16.5  |  |
| L5 | 49                             | 68    | 87    | 106   | 125   | 144   | 163   | 182   | 201   | 220   | 239   | 258   | 277   | 296   | 315   | 334   | 353   | 372   | 391   |  |



## Manifold Options

### Blanking plate assembly

**VVQZ100-10A-5 (for VQZ100)**

**VVQZ200-10A-2 (for VQZ200)**

**VVQZ300-10A-2 (for VQZ300)**

It is used by attaching on the manifold block for being prepared for removing a valve for maintenance reasons or planning to mount a spare valve, etc.

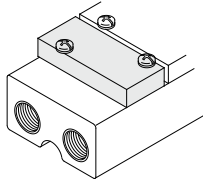

### Blanking plug

**KQ2P-23**

**KQ2P-04**

**KQ2P-06**

**KQ2P-08**

**KQ2P-10**

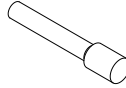
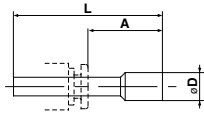

#### Dimensions

| Applicable fitting size ød | Model          | A    | L    | D  |
|----------------------------|----------------|------|------|----|
| 3.2                        | <b>KQ2P-23</b> | 16   | 31.5 | 5  |
| 4                          | <b>KQ2P-04</b> | 16   | 32   | 6  |
| 6                          | <b>KQ2P-06</b> | 18   | 35   | 8  |
| 8                          | <b>KQ2P-08</b> | 20.5 | 39   | 10 |
| 10                         | <b>KQ2P-10</b> | 22   | 43   | 12 |

### DIN rail

**AXT100-DR-□**

\* As for □, enter the number from the DIN rail dimensions table.  
For L dimension, refer to the dimensions of each kit.

Each manifold can be mounted on a DIN rail.  
Insert "D" at the end of the manifold part number.  
The DIN rail is approximately 30 mm longer than the length of manifold.

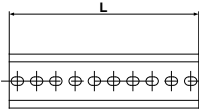

#### L Dimension

|             |     |       |     |       |     |       |     |       |     |       |     |       |     |       |     |       |     |       |     |       |
|-------------|-----|-------|-----|-------|-----|-------|-----|-------|-----|-------|-----|-------|-----|-------|-----|-------|-----|-------|-----|-------|
| No.         | 1   | 2     | 3   | 4     | 5   | 6     | 7   | 8     | 9   | 10    | 11  | 12    | 13  | 14    | 15  | 16    | 17  | 18    | 19  | 20    |
| L dimension | 23  | 35.5  | 48  | 60.5  | 73  | 85.5  | 98  | 110.5 | 123 | 135.5 | 148 | 160.5 | 173 | 185.5 | 198 | 210.5 | 223 | 235.5 | 248 | 260.5 |
| No.         | 21  | 22    | 23  | 24    | 25  | 26    | 27  | 28    | 29  | 30    | 31  | 32    | 33  | 34    | 35  | 36    | 37  | 38    | 39  | 40    |
| L dimension | 273 | 285.5 | 298 | 310.5 | 323 | 335.5 | 348 | 360.5 | 373 | 385.5 | 398 | 410.5 | 423 | 435.5 | 448 | 460.5 | 473 | 485.5 | 498 | 510.5 |

### Silencer

(for manifold EXH port)

Silencer is installed in the manifold EXH port.

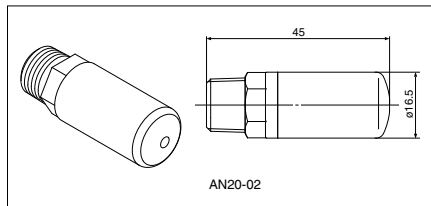
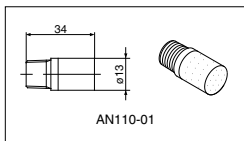

#### Dimensions

| Model         | Silencer part no. |
|---------------|-------------------|
| <b>VQZ100</b> | AN110-01          |
| <b>VQZ200</b> | AN110-01          |
| <b>VQZ300</b> | AN20-02           |

For a silencer to be mounted in a single valve unit, refer to page 1050.

## External Pilot Specification

The external pilot specification is used when the operating pressure is below the minimum operating pressure 0.1 to 0.15 MPa or when valve is used for a vacuum application. Order a valve by adding the external pilot specification [R] to the part number.

Valve Part No.

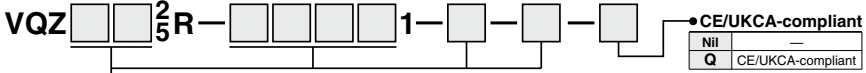

• Entry is the same as standard products.

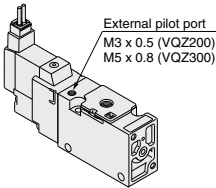

## Pressure Specifications

| Series                                      |                               | VQZ100 <sup>Note 2)</sup> | VQZ200/300      |
|---|-------------------------------|---------------------------|-----------------|
| External pilot pressure range               | <sup>Note 1)</sup> Metal seal | —                         | 0.1 to 0.7 MPa  |
|   | Rubber seal (VQZ100: poppet)  | 0.2 to 0.7 MPa            | 0.15 to 0.7 MPa |
| Operating pressure range <sup>Note 1)</sup> |                               | -100 kPa to 0.7 MPa       |                 |

Note 1) In case of the high pressure type, upper limit of max. operating pressure and external pilot pressure range is 1 MPa.

Note 2) Pump down from 1(P) port when VQZ100 series vacuum type is specified. Apply pressure from 3(R) port to relieve vacuum pressure. Set the release pressure at 50% of external pilot pressure or less.

In addition, when the VQZ100 is to be used at an operating pressure greater than 0.2 MPa, please assure that the operating pressure is set equal to or less than the external pilot pressure.

## Inch Size One-touch Fittings and Optional Threads

Inch size One-touch fittings and NPT, NPTF and G thread are available.

Valve Part No.

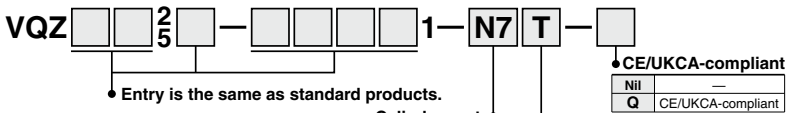

• Entry is the same as standard products.

Cylinder port

| Symbol                        | N1     | N3     | N7    | N9     | N11   | M5        | O2         |
|-------------------------------|--------|--------|-------|--------|-------|-----------|------------|
| Applicable tubing O.D. (Inch) | ø1/8"  | ø5/32" | ø1/4" | ø5/16" | ø3/8" | M5 thread | 1/4 thread |
| 2(A) port                     | VQZ100 | ●      | ●     | ●      | —     | ●         | —          |
|                               | VQZ200 | —      | ●     | ●      | —     | ●         | —          |
|                               | VQZ300 | —      | —     | ●      | ●     | —         | ●          |

Note) Metric size One-touch fittings (C1) are also available.

Thread type (Cylinder port and 1(P), 3(R) ports)

|     |      |
|-----|------|
| Nil | Rc   |
| N   | NPT  |
| T   | NPTF |
| F   | G    |

Note 1) 3(R) port of the VQZ200 is only G1/16.  
Note 2) Except VQZ100

Manifold Part No.

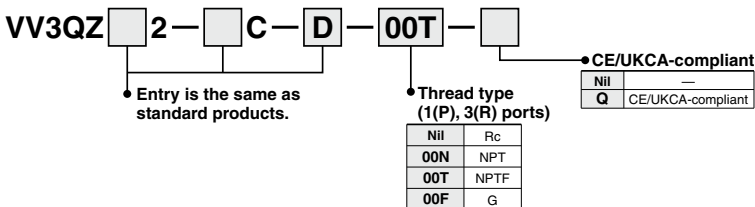

• Entry is the same as standard products.

• Thread type (1(P), 3(R) ports)

|     |      |
|-----|------|
| Nil | Rc   |
| 00N | NPT  |
| 00T | NPTF |
| 00F | G    |

## IP65 Enclosure (Based on IEC60529)

DIN terminal is available with IP65 enclosure.

Valve Part No.

(Applicable to the VQZ200/300 rubber seal with the exception of the external pilot type)



• Entry is the same as standard products.

Note) The pilot exhaust IP65 valves is common with main valve exhaust. (The standard valve has an individual exhaust for the pilot valve.)

## Replacement Parts

### One-touch Fitting Assembly (for Cylinder port)

| Model \ Fitting size | C3             | C4             | C6             | C8             | C10             | M5 (VQZ100 only) |
|----------------------|----------------|----------------|----------------|----------------|-----------------|------------------|
| <b>VQZ100/200</b>    | VVQ1000-50A-C3 | VVQ1000-50A-C4 | VVQ1000-50A-C6 | —              | —               | VVQ1000-50A-M5   |
| <b>VQZ300</b>        | —              | —              | VVQ1000-51A-C6 | VVQ1000-51A-C8 | VVQ1000-51A-C10 | —                |

Note) Purchasing order is available in units of 10 pieces.

#### <Plug connector assembly>

DC: SY100-30-4A-□

100 VAC: SY100-30-1A-□

200 VAC: SY100-30-2A-□

Other AC voltages: SY100-30-3A-□

Without lead wire: SY100-30-A  
(with connector and 2 sockets only)

#### Lead wire length

|     |         |
|-----|---------|
| Nil | 300 mm  |
| 6   | 600 mm  |
| 10  | 1000 mm |
| 15  | 1500 mm |
| 20  | 2000 mm |
| 25  | 2500 mm |
| 30  | 3000 mm |
| 50  | 5000 mm |

#### How to Order

Include the connector assembly part number together with the part number for the plug connector's solenoid valve without connector.

Example) In case of 2000 mm of lead wire

| DC                | AC                |
|-------------------|-------------------|
| VQZ115-5L01-M5-PR | VQZ115-1L01-M5-PR |
| SY100-30-4A-20    | SY100-30-1A-20    |

#### <Gasket and screw assembly>

| Model         | Part no.    |
|---------------|-------------|
| <b>VQZ100</b> | VQZ100-GS-5 |
| <b>VQZ200</b> | VQZ200-GS-2 |
| <b>VQZ300</b> | VQZ300-GS-2 |

Note 1) The above part numbers are for 10 valves (a set of 10 gaskets and 20 screws).

Note 2) VQZ100 is common to the body ported type and base mounted type.

#### <Bracket assembly>

| Model         | Part no.  | Tightening torque (N·m) <small>Note1)</small> |
|---------------|-----------|---|
| <b>VQZ100</b> | VQZ100-FB | 0.25 to 0.35                                  |
| <b>VQZ200</b> | VQZ200-FB |   |
| <b>VQZ300</b> | VQZ300-FB |   |

Note) Tightening torque when mounting a bracket on the valve.

#### <Pilot valve assembly>

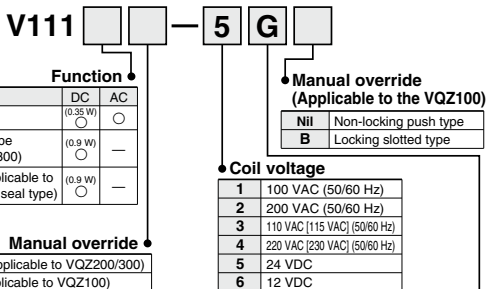

#### <DIN terminal type (Applicable to the VQZ200/300)>

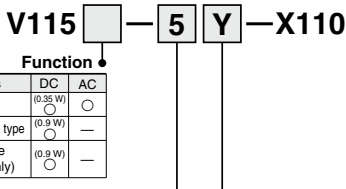

### ⚠ Caution

When replacing only the pilot valve assembly, use caution because it is not possible to convert to a V115 (DIN terminal) from a V111 (Grommet, L-type, M-type), or vice versa.

Base Mounted  
Plug Lead Unit

# 3 Port Solenoid Valve

# VQZ100/200/300 Series

## Single Unit



[Option]

Note) For CE/UKCA-compliant models, DC type only.

### VQZ100 / How to Order Valve

VQZ 1 1 5 [ ] - 5 M [ ] 1 - 01 - [ ]

Series ●  
1 VQZ100 body width 10 mm

Type of actuation ●  
1 N.C. 2(A) (P) 1 3(R)

Body type ●  
5 Base mounted

● CE/UKCA-compliant

|     |                   |
|-----|-------------------|
| Nil | —                 |
| Q   | CE/UKCA-compliant |

Note) For CE/UKCA-compliant models, DC type only.

● Port size

|    |                   |
|----|-------------------|
| CP | Without sub-plate |
| 01 | Rc 1/8            |

Note) For optional thread type, refer to page 1045.

● Manual override

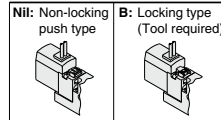

● Function

| Symbol        | Specifications                    | DC                 | AC |
|---------------|-----------------------------------|--------------------|----|
| Nil           | Standard                          | ○ (0.35 W) Note 3) | ○  |
| K Note 1)     | High pressure type                | ○ (0.9 W)          | —  |
| R Note 1, 2)  | External pilot type               | ○                  | ○  |
| KR Note 1, 2) | High pressure/External pilot type | ○ (0.9 W)          | —  |

Note 1) Semi-standard  
Note 2) For details on external pilot type, refer to page 1045.  
Note 3) For AC specification power consumption, refer to page 1032.



**Caution**  
Use standard (DC) specification for continuous duty.

● Electrical entry

| G: Grommet (DC specification) | L: L-type plug connector with lead wire | LO: L-type plug connector without connector | M: M-type plug connector with lead wire | MO: M-type plug connector without connector |
|-------------------------------|---|---|---|---|
|                               | With light/surge voltage suppressor     | With light/surge voltage suppressor         | With light/surge voltage suppressor     | With light/surge voltage suppressor         |
|                               |   |   |   |   |

Note) Standard lead wire length: 300 mm

● Coil voltage

|                                | CE/UKCA-compliant |
|--------------------------------|-------------------|
| 1 100 VAC (50/60 Hz)           | —                 |
| 2 200 VAC (50/60 Hz)           | —                 |
| 3 110 VAC [115 VAC] (50/60 Hz) | —                 |
| 4 220 VAC [230 VAC] (50/60 Hz) | —                 |
| 5 24 VDC                       | ●                 |
| 6 12 VDC                       | ●                 |

Note) For sub-plate part no., refer to page 1046.  
Note) When ordering single unit of the base mounted type solenoid valve, the mounting screws and gaskets for the manifold are included.

## VQZ200/300 / How to Order Valve



Made to Order

(For details, refer to pages 1032 and 1047.)

Note) AC-type models that are CE/UKCA-compliant have DIN terminals only.



**VQZ 2 1 5** - **5 M** - **1** -

### Series

|   |                         |
|---|-------------------------|
| 2 | VQZ200 body width 15 mm |
| 3 | VQZ300 body width 18 mm |

### Type of actuation

|   |      |      |             |
|---|------|------|-------------|
| 1 | N.C. | 2(A) | Metal seal  |
|   | (R)S | 1(F) |             |
| 2 | N.O. | 2(A) | Metal seal  |
|   | (R)S | 1(F) |             |
| 3 | N.C. | 2(A) | Rubber seal |
|   | (R)S | 1(F) |             |
| 4 | N.O. | 2(A) | Rubber seal |
|   | (R)S | 1(F) |             |

### Body type

|   |              |
|---|--------------|
| 5 | Body mounted |
|---|--------------|

### Function

| Symbol                              | Specifications   | DC                              | AC |
|-------------------------------------|--|---------------------------------|----|
| <b>Nil</b>                          | Standard   | (0.35 W) <small>Note 3)</small> | —  |
| <b>B</b> <small>Note 1)</small>     | High speed response type                                 | (0.9 W) ○                       | —  |
| <b>K</b> <small>Note 1)</small>     | High pressure type (Metal seal type only)                | (0.9 W) ○                       | —  |
| <b>R</b> <small>Note 1, 2)</small>  | External pilot type                                      | ○                               | ○  |
| <b>BR</b> <small>Note 1, 2)</small> | High speed response/External pilot type                  | (0.9 W) ○                       | —  |
| <b>KR</b> <small>Note 1, 2)</small> | High pressure/External pilot type (Metal seal type only) | (0.9 W) ○                       | —  |

Note 1) Semi-standard

Note 2) For details on external pilot type, refer to page 1045.

Note 3) For AC specification power consumption, refer to page 1032.



**Caution**  
Use standard (DC) specification for continuous duty.

### IP65 compliant

|                               |           |
|-------------------------------|-----------|
| <b>Nil</b>                    | —         |
| <b>W</b> <small>Note)</small> | Compliant |

Note) VQZ200/300 DIN terminal rubber seal only (except external pilot). For details on IP65 enclosure, refer to page 1045.

### CE/UKCA-compliant

|            |                   |
|------------|-------------------|
| <b>Nil</b> | —                 |
| <b>Q</b>   | CE/UKCA-compliant |

Note) AC-type models that are CE/UKCA-compliant have DIN terminals only.

### Port size

| Symbol     | Port size         | VQZ200 | VQZ300 |
|------------|-------------------|--------|--------|
| <b>Nil</b> | Without sub-plate | ○      | ○      |
| <b>01</b>  | Rc 1/8            | ○      | —      |
| <b>02</b>  | Rc 1/4            | ○      | ○      |
| <b>03</b>  | Rc 3/8            | —      | ○      |

Note) For optional thread type, refer to page 1045.

### Manual override

|  |   |
|--|---|
| <b>Nil</b> : Non-locking push type (Tool required) | <b>B</b> : Locking type (Tool required) |
|  |   |

### Electrical entry

|                   | <b>G</b> : Grommet (DC specification) | <b>L</b> : L-type plug connector with lead wire | <b>LO</b> : L-type plug connector without connector | <b>M</b> : M-type plug connector with lead wire                | <b>MO</b> : M-type plug connector without connector |
|-------------------|---------------------------------------|---|---|--|---|
|                   |                                       | With light/surge voltage suppressor<br>         | With light/surge voltage suppressor<br>             | With light/surge voltage suppressor<br>                        | With light/surge voltage suppressor<br>             |
| CE/UKCA-compliant | AC                                    | —   | —   | —  | —   |
|                   | DC                                    | —   | —   | —  | —   |
|                   | <b>Y</b> : DIN terminal               | <b>YO</b> : DIN terminal without connector      | <b>YZ</b> : DIN terminal                            | <b>YOS</b> : DIN terminal without connector (DC specification) | <b>YS</b> : DIN terminal (DC specification)         |
|                   |                                       |   | With light/surge voltage suppressor<br>             | With surge voltage suppressor<br>                              | With surge voltage suppressor<br>                   |
| CE/UKCA-compliant | AC                                    | ●   | ●   | —  | —   |
|                   | DC                                    | ●   | ●   | ●  | ●   |

Note 1) Standard lead wire length: 300 mm

Note 2) For AC voltage valves there is no "S" type. It is already built-in to the rectifier circuit.

### Coil voltage

|   |                              |
|---|------------------------------|
| 1 | 100 VAC (50/60 Hz)           |
| 2 | 200 VAC (50/60 Hz)           |
| 3 | 110 VAC [115 VAC] (50/60 Hz) |
| 4 | 220 VAC [230 VAC] (50/60 Hz) |
| 5 | 24 VDC                       |
| 6 | 12 VDC                       |

Note) For sub-plate part no., refer to page 1046.

Note) When ordering single unit of the base mounted type solenoid valve, the mounting screws and gaskets for the manifold are included.

# VQZ100/200/300 Series

## Specifications

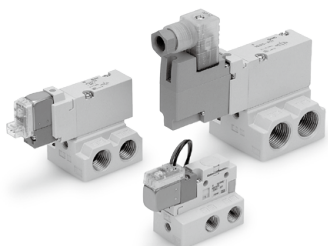

| Valve construction   | Metal seal   | Rubber seal | Poppet seal (VQZ100)          |
|--|--|-------------|-------------------------------|
| Fluid  | Air  |             |                               |
| Max. operating pressure (MPa)                                      | 0.7 (High pressure type: 1.0)                      | 0.7         | 0.7 (High pressure type: 1.0) |
| Min. operating pressure (MPa)                                      | 0.1  | 0.15        | 0.15                          |
| Ambient and fluid temperature (°C)                                 | -10 to 50 (No freezing)                            |             |                               |
| Max. operating frequency (Hz)                                      | 20   | 5           | 20                            |
| Pilot exhaust method   | Individual exhaust                                 |             | Common exhaust                |
| Lubrication  | Not required                                       |             |                               |
| Manual override  | Push type, Locking type (Tool required)            |             |                               |
| Mounting orientation   | Free   |             |                               |
| Impact/Vibration resistance (m/s <sup>2</sup> ) <sup>Note 1)</sup> | 150/30   |             |                               |
| Enclosure*   | Dustproof (DIN terminal: IP65 <sup>Note 2)</sup> ) |             |                               |

\* Based on IEC60529

Note 1) Impact resistance: No malfunction occurred when it is tested with a drop tester in the axial direction and at the right angles to the main valve and armature in both energized and de-energized states every once for each condition. (Value in the initial state)

Vibration resistance: No malfunction occurred in one sweep test between 45 and 2000 Hz. Test was performed to axis and right angle directions of the main valve and armature when pilot signal is ON and OFF. (Value in the initial state)

Note 2) When IP65 compliant DIN terminals are selected: VQZ□□□□□Y□□W1□□□

## Solenoid Specifications

### Semi-standard Specifications

|   |
|---|
| High speed response type                  |
| High pressure type (Metal seal type only) |
| External pilot type*                      |

\* For details on external pilot type, refer to page 1045.



**Made to Order**  
(For details, refer to page 1047.)

| Symbol      | Description                |
|-------------|----------------------------|
| <b>X30</b>  | Pilot valve common exhaust |
| <b>X90</b>  | Main valve fluororubber    |
| <b>X113</b> | All fluororubber           |

| Electrical entry              | Grommet (G)                                |                                    | M-type plug connector (M)                               |                          |
|-------------------------------|--|------------------------------------|---|--------------------------|
|                               | L-type plug connector (L)                  |                                    | DIN terminal (Y)  |                          |
|                               | G, L, M                                    |                                    | Y   |                          |
| Coil rated voltage (V)        | DC   | 24, 12                             |   |                          |
|                               | AC 50/60 Hz                                | 100, 110, 200, 220*                |   |                          |
| Allowable voltage fluctuation | ±10% of rated voltage*                     |                                    |   |                          |
| Power consumption (W)         | DC   | Standard                           | 0.35 [(With light: 0.4 (DIN terminal with light: 0.45)] |                          |
|                               |  | High speed response, high pressure | 0.9 [(With light: 0.95 (DIN terminal with light: 1.0)]  |                          |
| Apparent power (VA)           | AC   | 100 V                              | 0.78 (With light: 0.81)                                 | 0.78 (With light: 0.87)  |
|                               |  | 110 V [115 V]                      | 0.86 (With light: 0.89)                                 | 0.86 (With light: 0.87)  |
|                               |  | 200 V                              | 1.18 (With light: 1.22)                                 | 1.15 (With light: 1.30)  |
|                               |  | 220 V [230 V]                      | 1.30 (With light: 1.34)                                 | 1.27 (With light: 1.46)  |
|                               |  |                                    | 1.42 (With light: 1.46)]                                | 1.39 (With light: 1.60)] |
| Surge voltage suppressor      | Varistor                                   |                                    |   |                          |
| Indicator light               | LED (Neon light when AC with DIN terminal) |                                    |   |                          |

\* In common between 110 VAC and 115 VAC, and between 220 VAC and 230 VAC.

\* For 115 VAC and 230 VAC, the allowable voltage is -15% to +5% of rated voltage.

## Flow Rate Characteristics

| Series | Type of actuation | Model       | Flow rate characteristics    |      |      |                              |     |      | Response time (ms) <sup>Note 1)</sup> |                            |                      |            | Weight (g) <sup>Note 2)</sup> |    |
|--------|-------------------|-------------|------------------------------|------|------|------------------------------|-----|------|---------------------------------------|----------------------------|----------------------|------------|-------------------------------|----|
|        |                   |             | 1 → 2 (P → A)                |      |      | 2 → 3 (A → R)                |     |      | Standard: 0.35 W                      | High speed response: 0.9 W | High pressure: 0.9 W | AC         |                               |    |
|        |                   |             | C [dm <sup>3</sup> /(s·bar)] | b    | Cv   | C [dm <sup>3</sup> /(s·bar)] | b   | Cv   |                                       |                            |                      |            |                               |    |
| VQZ100 | N.C. valve        | Poppet      | VQZ115                       | 0.87 | 0.46 | 0.23                         | 1.0 | 0.35 | 0.25                                  | 10 or less                 | —                    | 13 or less | 22 or less                    | 24 |
|        | N.C. valve        | Metal seal  | VQZ215                       | 1.7  | 0.17 | 0.38                         | 2.0 | 0.20 | 0.45                                  | 22 or less                 | 14 or less           | 18 or less | 34 or less                    |    |
| VQZ200 | N.C. valve        | Rubber seal | VQZ235                       | 2.3  | 0.46 | 0.65                         | 3.0 | 0.40 | 0.80                                  | 22 or less                 | 15 or less           | —          | 36 or less                    | 52 |
|        |                   | Metal seal  | VQZ225                       | 1.7  | 0.18 | 0.38                         | 1.8 | 0.21 | 0.39                                  | 22 or less                 | 14 or less           | 18 or less | 34 or less                    |    |
|        | N.O. valve        | Rubber seal | VQZ245                       | 2.5  | 0.43 | 0.67                         | 3.0 | 0.30 | 0.74                                  | 22 or less                 | 15 or less           | —          | 36 or less                    |    |
|        |                   | Metal seal  | VQZ315                       | 3.0  | 0.21 | 0.70                         | 3.2 | 0.27 | 0.80                                  | 22 or less                 | 17 or less           | 22 or less | 34 or less                    |    |
| VQZ300 | N.C. valve        | Rubber seal | VQZ335                       | 4.5  | 0.42 | 1.3                          | 4.1 | 0.36 | 1.0                                   | 33 or less                 | 25 or less           | —          | 57 or less                    | 78 |
|        |                   | Metal seal  | VQZ325                       | 2.9  | 0.21 | 0.72                         | 2.9 | 0.16 | 0.69                                  | 22 or less                 | 17 or less           | 22 or less | 34 or less                    |    |
|        | N.O. valve        | Rubber seal | VQZ345                       | 4.4  | 0.45 | 1.2                          | 4.5 | 0.38 | 1.2                                   | 33 or less                 | 25 or less           | —          | 57 or less                    |    |

Note 1) Based on JIS B 8419:2010 (Supply pressure: 0.5 MPa; with light/surge voltage suppressor: clean air)

Response time values will change depending on pressure and air quality.

Note 2) Weight without sub-plate.

## Construction

### VQZ100 Poppet type

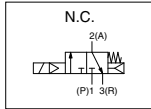
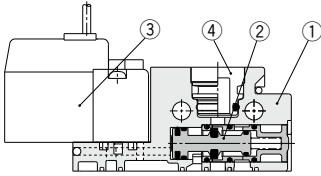

### Component Parts

| No. | Description          | Material      | Note      |
|-----|----------------------|---------------|-----------|
| 1   | Body                 | Resin         |           |
| 2   | Spool valve          | Aluminum/HNBR |           |
| 3   | Pilot valve assembly | —             |           |
| 4   | Port plug            | Resin/HNBR    | VQZ100-CP |

### VQZ200/300 Metal seal type

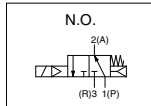
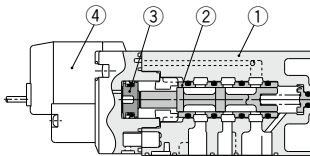
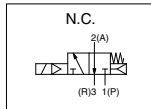
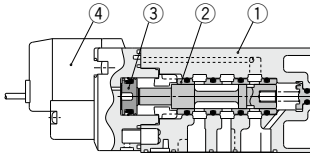

### Rubber seal type

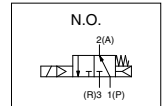
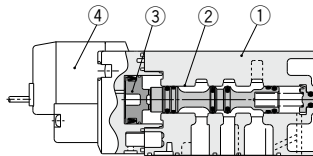
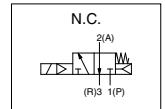
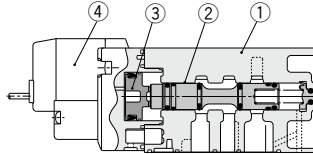

### Component Parts

| No. | Description          | Material            | Note        |
|-----|----------------------|---------------------|-------------|
| 1   | Body                 | Aluminum die-casted |             |
| 2   | Spool, Sleeve        | Stainless steel     | Metal seal  |
| 2   | Spool valve          | Aluminum/HNBR       | Rubber seal |
| 3   | Piston               | Resin               |             |
| 4   | Pilot valve assembly | —                   |             |

Note) For "How to Order Pilot Valve Assembly", refer to page 1046.

# VQZ100/200/300 Series

## Dimensions: VQZ100

### Single Unit

Grommet (G): VQZ115□-□G□1-01

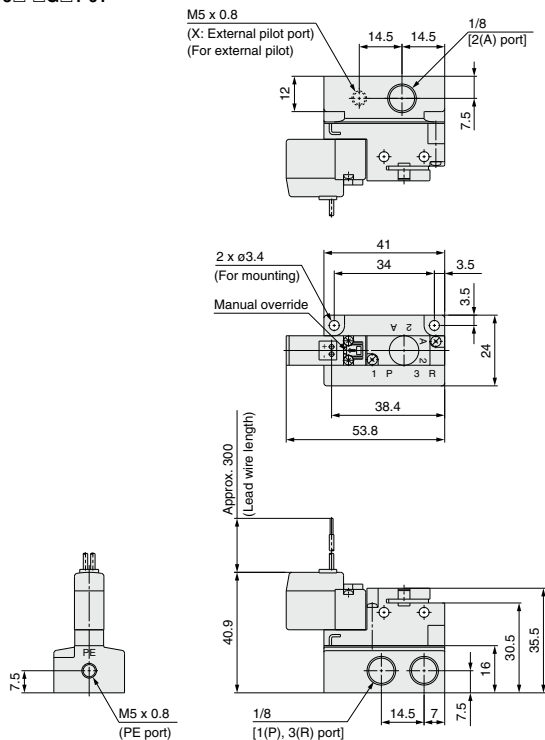

### L-type plug connector (L): VQZ115□-□L□1-01

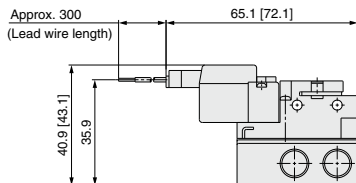

### M-type plug connector (M): VQZ115□-□M□1-01

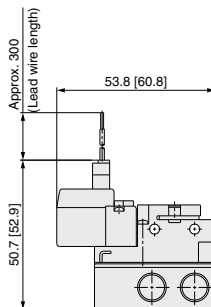

Unless otherwise indicated, dimensions are the same as Grommet (G).  
[ ]: AC

Unless otherwise indicated, dimensions are the same as Grommet (G).  
[ ]: AC



## Dimensions: VQZ200

### Single Unit

Grommet (G): VQZ2□5□-□G□1-<sup>01</sup>/<sub>02</sub>

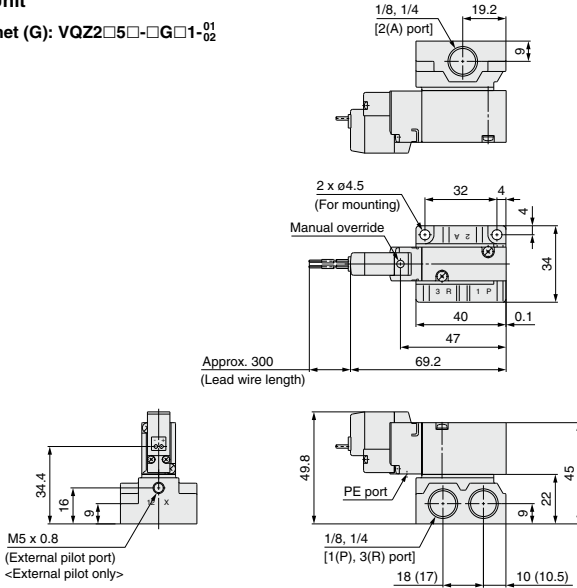

( ): VQZ215-□G□1-01

L-type plug connector (L): VQZ2□5□-□L□1-<sup>01</sup>/<sub>02</sub>

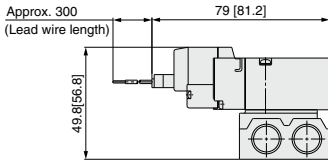

Unless otherwise indicated, dimensions are the same as Grommet (G).  
[ ] : AC

M-type plug connector (M): VQZ2□5□-□M□1-<sup>01</sup>/<sub>02</sub>

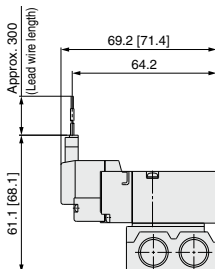

Unless otherwise indicated, dimensions are the same as Grommet (G).  
[ ] : AC

DIN terminal (Y): VQZ2□5□-□Y□□1-<sup>01</sup>/<sub>02</sub>

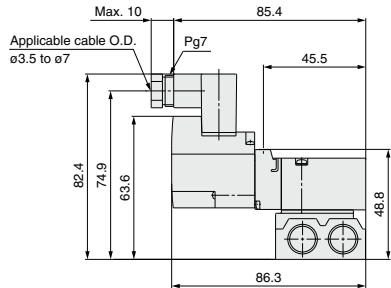

Unless otherwise indicated, dimensions are the same as Grommet (G).  
[ ] : AC

# VQZ100/200/300 Series

## Dimensions: VQZ300

### Single Unit

Grommet (G): VQZ3□5□-□G□1-02<sup>02</sup>/<sub>03</sub>

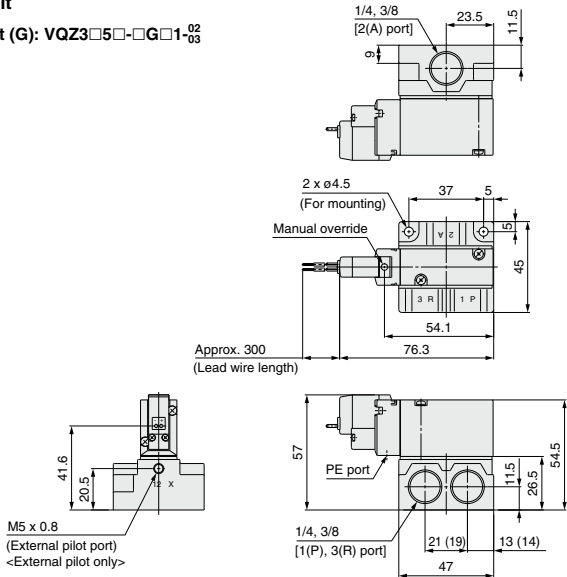

( ) : VQZ315-□G□1-02

L-type plug connector (L): VQZ3□5□-□L□1-02<sup>02</sup>/<sub>03</sub>

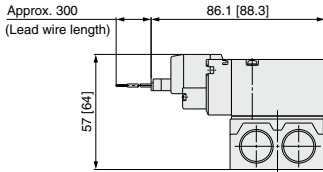

Unless otherwise indicated, dimensions are the same as Grommet (G).  
[ ] : AC

M-type plug connector (M): VQZ3□5□-□M□1-02<sup>02</sup>/<sub>03</sub>

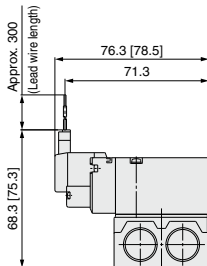

Unless otherwise indicated, dimensions are the same as Grommet (G).  
[ ] : AC

DIN terminal (Y): VQZ3□5□-□Y□□1-02<sup>02</sup>/<sub>03</sub>

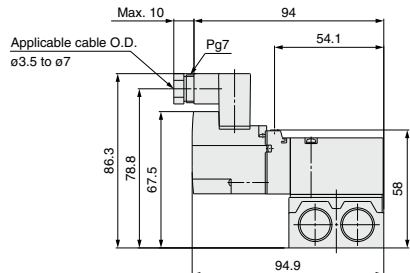

Unless otherwise indicated, dimensions are the same as Grommet (G).

Base Mounted  
Plug Lead Unit

# 3 Port Solenoid Valve

## VQZ100/200/300 Series

### Manifold Connector Kit



[Option]

Note) For CE/UKCA-compliant models, DC-type only.

### VQZ100 / How to Order Manifold

**VV3QZ 1 5 - 08 C6 C -**

**Series**  
1 VQZ100

**Manifold type**  
5 Base mounted

**Stations**

|    |             |
|----|-------------|
| 02 | 2 stations  |
| ⋮  | ⋮           |
| 20 | 20 stations |

**Port size [2(A) port]**

|                       |                              |                 |
|-----------------------|------------------------------|-----------------|
| C3                    | ø3.2 One-touch fitting       | For side ported |
| C4                    | ø4 One-touch fitting         |                 |
| C6                    | ø6 One-touch fitting         |                 |
| M5                    | M5 thread (Replaceable type) | For top ported  |
| CP <sup>Note 1)</sup> | With port plug               |                 |
| CM <sup>Note 2)</sup> | Mixed port sizes             | —               |

**CE/UKCA-compliant**

|     |                   |
|-----|-------------------|
| Nil | —                 |
| Q   | CE/UKCA-compliant |

**Option**

|                     |   |
|---------------------|---|
| Nil                 | None  |
| D                   | DIN rail mounting (With standard DIN rail length) |
| D0 <sup>Note)</sup> | DIN rail mounting (Without DIN rail)              |
| R                   | External pilot type                               |

Note 1) Order DIN rail separately.  
For DIN rail part no., refer to page 1044.  
Note 2) When two or more symbols are specified, indicate them alphabetically.

**Kit type**  
C Connector

Note 1) When CP port plug is attached on all 2(A) port. Valve on manifold is top ported.  
Note 2) Specify the mixture port (including top and side piping) by the manifold specification sheet.  
Note 3) For inch size One-touch fittings, refer to page 1045.

### VQZ100 / How to Order Valve

**VQZ 1 1 5 - 5 M 1 - C4 -**

**Series**  
1 VQZ100 body width 10 mm

**Type of actuation**  
1 N.C.

**Body type**  
5 Base mounted

**Function**

| Symbol                   | Specifications                    | DC                          | AC |
|--------------------------|-----------------------------------|-----------------------------|----|
| Nil                      | Standard                          | (0.35 W) <sup>Note 3)</sup> | —  |
| K <sup>Note 1)</sup>     | High pressure type                | ○                           | —  |
| R <sup>Note 1, 2)</sup>  | External pilot type               | ○                           | ○  |
| KR <sup>Note 1, 2)</sup> | High pressure/External pilot type | (0.9 W) <sup>Note 3)</sup>  | —  |

**Coil voltage**

|                                | CE/UKCA-compliant |
|--------------------------------|-------------------|
| 1 100 VAC (50/60 Hz)           | —                 |
| 2 200 VAC (50/60 Hz)           | —                 |
| 3 110 VAC (115 VAC) (50/60 Hz) | —                 |
| 4 220 VAC (230 VAC) (50/60 Hz) | —                 |
| 5 24 VDC                       | ●                 |
| 6 12 VDC                       | ●                 |

**CE/UKCA-compliant**

|     |                   |
|-----|-------------------|
| Nil | —                 |
| Q   | CE/UKCA-compliant |

Note) For CE/UKCA-compliant models, DC type only.

**Port size**

|    |                        |                 |
|----|------------------------|-----------------|
| CP | With port plug         | For side ported |
| C3 | ø3.2 One-touch fitting | For top ported  |
| C4 | ø4 One-touch fitting   |                 |
| C6 | ø6 One-touch fitting   |                 |
| M5 | M5 thread              | —               |

Note) For inch size One-touch fittings, refer to page 1045.

**Manual override**

|     |                                       |
|-----|---------------------------------------|
| Nil | Non-locking push type (Tool required) |
| B   | Locking type (Tool required)          |

**Electrical entry**

| Symbol | Electrical entry                        | Light/surge voltage suppressor |
|--------|---|--------------------------------|
| G      | Grommet (DC specification)              | None                           |
| L      | L-plug plug connector with lead wire    | Yes                            |
| LO     | L-plug plug connector without connector |                                |
| M      | M-plug plug connector with lead wire    |                                |
| MO     | M-plug plug connector without connector |                                |

Note) Standard lead wire length: 300 mm  
Note) When ordering single unit of the base mounted type solenoid valve, the mounting screws and gaskets for the manifold are included.

**Caution**  
Use standard (DC) specification for continuous duty.

# VQZ100/200/300 Series

## VQZ200/300 / How to Order Manifold



Made to Order  
(For details, refer to page 1047.)

Note) AC-type models that are CE/UKCA-compliant have DIN terminals only.



**VV3QZ 2 5 - 08 C6 C - - -**

**Series**

|   |        |
|---|--------|
| 2 | VQZ200 |
| 3 | VQZ300 |

**Manifold type**

|   |              |
|---|--------------|
| 5 | Base mounted |
|---|--------------|

**Stations**

|    |             |
|----|-------------|
| 02 | 2 stations  |
| :  | :           |
| 20 | 20 stations |

**Port size [2(A) port]**

| Symbol | Port size             | VQZ200 | VQZ300 |
|--------|-----------------------|--------|--------|
| C4     | ø4 One-touch fitting  | ○      | —      |
| C6     | ø6 One-touch fitting  | ○      | ○      |
| C8     | ø8 One-touch fitting  | ○      | ○      |
| C10    | ø10 One-touch fitting | —      | ○      |
| 01     | Rc 1/8                | ○      | —      |
| 02     | Rc 1/4                | —      | ○      |
| CM     | Mixed port sizes      | ○      | ○      |

**CE/UKCA-compliant**

|     |                   |
|-----|-------------------|
| Nil | —                 |
| Q   | CE/UKCA-compliant |

**Option**

|     |   |
|-----|---|
| Nil | None  |
| D   | DIN rail mounting (With standard DIN rail length) |
| DO  | DIN rail mounting (Without DIN rail)              |
| R   | External pilot type                               |

Note 1) Order DIN rail separately.  
For DIN rail part no., refer to page 1044.  
Note 2) When two or more symbols are specified, indicate them alphabetically.

**Kit type**

|   |           |
|---|-----------|
| C | Connector |
|---|-----------|

Note 1) Specify port mixture/with port plug by means of the manifold specification sheet. Port mixture and port plug are available only for one-touch fitting type.  
Note 2) For inch size One-touch fittings, refer to page 1045.

## VQZ200/300 / How to Order Valve

**VQZ 2 1 5 - 5 M - - 1 - -**

**Series**

|   |                         |
|---|-------------------------|
| 2 | VQZ200 body width 15 mm |
| 3 | VQZ300 body width 18 mm |

**Type of actuation**

|   |                  |
|---|------------------|
| 1 | N.C. Metal seal  |
| 2 | N.O. Metal seal  |
| 3 | N.C. Rubber seal |
| 4 | N.O. Rubber seal |

**Body type**

|   |              |
|---|--------------|
| 5 | Base mounted |
|---|--------------|

**Function**

| Symbol | Specifications   | DC         | AC        |
|--------|--|------------|-----------|
| Nil    | Standard   | (0.35 W) ○ | Note 3) ○ |
| B      | High speed response type                                 | (0.9 W) ○  | —         |
| K      | High pressure type (Metal seal type only)                | (0.9 W) ○  | —         |
| R      | External pilot type                                      | ○          | ○         |
| BR     | High speed response/External pilot type                  | (0.9 W) ○  | ○         |
| KR     | High pressure/External pilot type (Metal seal type only) | (0.9 W) ○  | —         |

Note 1) Semi-standard  
Note 2) For details on external pilot type, refer to page 1045.  
Note 3) For AC specification power consumption, refer to page 1032.

**CE/UKCA-compliant**

|     |                   |
|-----|-------------------|
| Nil | —                 |
| Q   | CE/UKCA-compliant |

Note) AC-type models that are CE/UKCA-compliant have DIN terminals only.

**IP65 compliant**

|     |           |
|-----|-----------|
| Nil | —         |
| W   | Compliant |

Note) VQZ200/300 DIN terminal rubber seal only (except external pilot). For details on IP65 enclosure, refer to page 1045.

**Manual override**

|     |                                       |
|-----|---------------------------------------|
| Nil | Non-locking push type (Tool required) |
| B   | Locking type (Tool required)          |

**Electrical entry**

| Symbol | Electrical entry                                  | Light/surge voltage suppressor | AC | DC |
|--------|---|--------------------------------|----|----|
| G      | Grommet (DC specification)                        | None                           | —  | ●  |
| L      | L-type plug connector with lead wire              | —                              | —  | ●  |
| LO     | L-type plug connector without connector           | —                              | —  | ●  |
| M      | M-type plug connector with lead wire              | Yes                            | —  | ●  |
| MO     | M-type plug connector without connector           | —                              | —  | ●  |
| Y      | DIN terminal                                      | —                              | ●  | ●  |
| YO     | DIN terminal without connector                    | None                           | ●  | ●  |
| YZ     | DIN terminal                                      | Yes                            | ●  | ●  |
| YS     | DIN terminal (DC specification)                   | Yes                            | —  | ●  |
| YOS    | DIN terminal without connector (DC specification) | (Without light)                | —  | ●  |

Note 1) Standard lead wire length: 300 mm  
Note 2) For AC voltage valves there is no "S" type. It is already built-in to the rectifier circuit.

**Coil voltage**

|   |                              |
|---|------------------------------|
| 1 | 100 VAC (50/60 Hz)           |
| 2 | 200 VAC (50/60 Hz)           |
| 3 | 110 VAC [115 VAC] (50/60 Hz) |
| 4 | 220 VAC [230 VAC] (50/60 Hz) |
| 5 | 24 VDC                       |
| 6 | 12 VDC                       |



**Caution**  
Use standard (DC) specification for continuous duty.

Note) When ordering single unit of the base mounted type solenoid valve, the mounting screws and gaskets for the manifold are included.

## Manifold Specifications

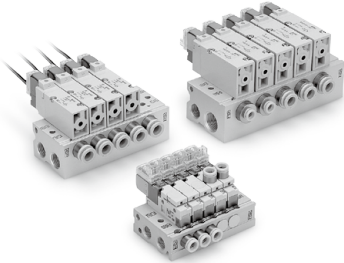

| Series | Base model  | Piping specifications |  |   | Applicable solenoid valve | Applicable stations | Manifold base weight (g)<br><small>Note)</small> |
|--------|-------------|-----------------------|--|---|---------------------------|---------------------|--|
|        |             | Piping direction      | Port size                                  |   |                           |                     |  |
|        |             |                       | 1(P), 3(R)                                 | 2(A)  |                           |                     |  |
| VQZ100 | VV3QZ15-□□□ | Side/Top              | Rc 1/8                                     | C3 (for ø3.2)<br>C4 (for ø4)<br>C6 (for ø6)<br>M5 (M5 thread) | VQZ115                    | 2 to 20 stations    | 2 stations: 83<br>Addition per station: 19       |
| VQZ200 | VV3QZ25-□□□ | Side                  | Rc 1/4                                     | C4 (for ø4)<br>C6 (for ø6)<br>C8 (for ø8)<br>Rc 1/8           | VQZ2□5                    | 2 to 20 stations    | 2 stations: 126<br>Addition per station: 38      |
| VQZ300 | VV3QZ35-□□□ | Side                  | 1(P) port<br>Rc 3/8<br>3(R) port<br>Rc 1/4 | C6 (for ø6)<br>C8 (for ø8)<br>C10 (for ø10)<br>Rc 1/4         | VQZ3□5                    | 2 to 20 stations    | 2 stations: 209<br>Addition per station: 60      |

Note) Weight for threaded connection.

## How to Order Manifold Assembly (Example)

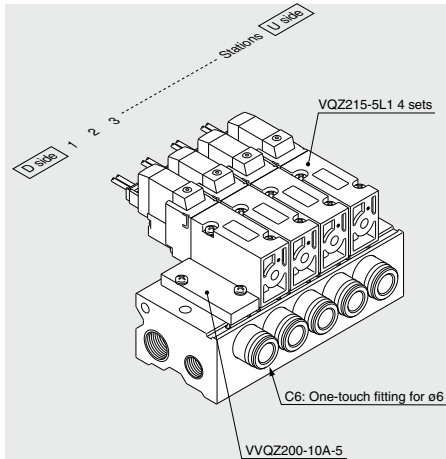

**VV3QZ25-05C6C** ..... 1 set (C kit 5-station manifold base part no.)  
**VVQZ200-10A-5** ..... 1 set (Blanking plate assembly part no.)  
**VQZ215-5L1** ..... 4 sets (N.C. type part no.)

The asterisk denotes the symbol for assembly.  
 Prefix it to the part nos. of the solenoid valve, etc.

Enter in order starting from the first station on the D side.

Add the valve and option part number under the manifold base part number.  
 When entry of part numbers becomes complicated, indicate by the manifold specification sheet.

# VQZ100/200/300 Series

## Dimensions: VQZ100: Top Ported

VV3QZ15- [Stations] [Port size] C

### Grommet (G)

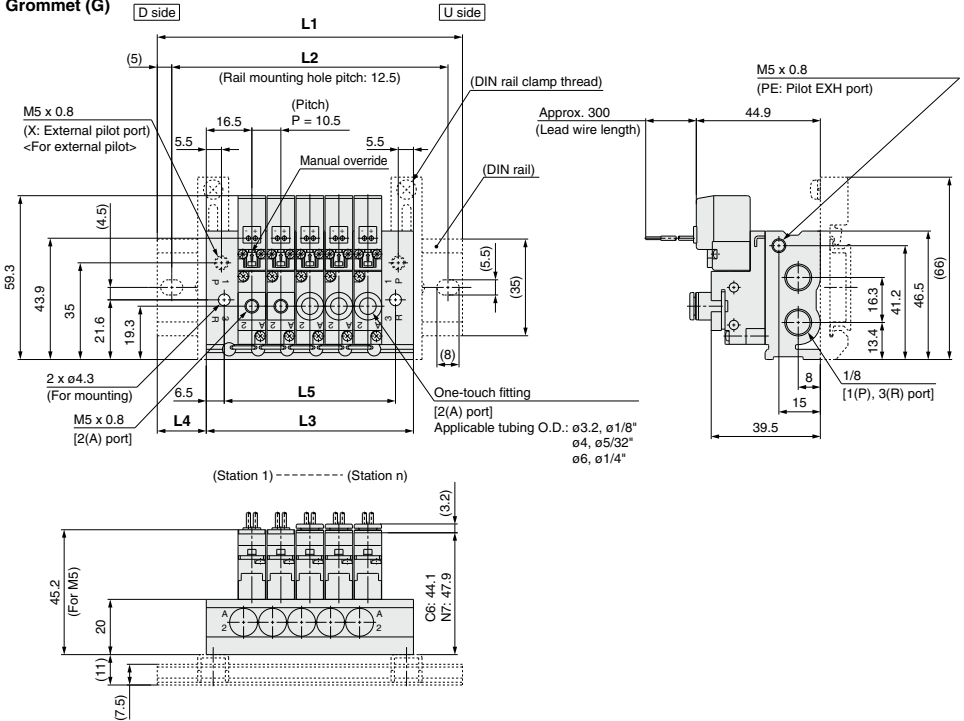

The dashed lines indicate the DIN rail mounting [-D].

### M5

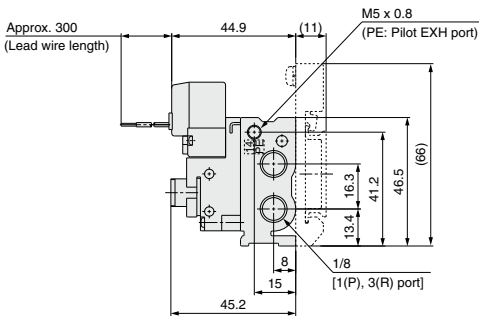

### Dimensions

n: Stations (Max. 20 stations)

| n         | 2    | 3    | 4    | 5     | 6     | 7     | 8     | 9     | 10    | 11    | 12    | 13    | 14    | 15    | 16    | 17    | 18    | 19    | 20    |
|-----------|------|------|------|-------|-------|-------|-------|-------|-------|-------|-------|-------|-------|-------|-------|-------|-------|-------|-------|
| <b>L1</b> | 85.5 | 85.5 | 98   | 110.5 | 123   | 135.5 | 148   | 148   | 160.5 | 173   | 185.5 | 198   | 210.5 | 210.5 | 223   | 235.5 | 248   | 260.5 | 273   |
| <b>L2</b> | 75   | 75   | 87.5 | 100   | 112.5 | 125   | 137.5 | 137.5 | 150   | 162.5 | 175   | 187.5 | 200   | 200   | 212.5 | 225   | 237.5 | 250   | 262.5 |
| <b>L3</b> | 43.5 | 54   | 64.5 | 75    | 85.5  | 96    | 106.5 | 117   | 127.5 | 138   | 148.5 | 159   | 169.5 | 180   | 190.5 | 201   | 211.5 | 222   | 232.5 |
| <b>L4</b> | 21   | 16   | 17   | 18    | 19    | 20    | 21    | 15.5  | 16.5  | 17.5  | 18.5  | 19.5  | 20.5  | 15.5  | 16.5  | 17.5  | 18.5  | 19.5  | 20.5  |
| <b>L5</b> | 30.5 | 41   | 51.5 | 62    | 72.5  | 83    | 93.5  | 104   | 114.5 | 125   | 135.5 | 146   | 156.5 | 167   | 177.5 | 188   | 198.5 | 209   | 219.5 |

## Dimensions: VQZ100: Side Ported

VV3QZ15- Stations Port size C

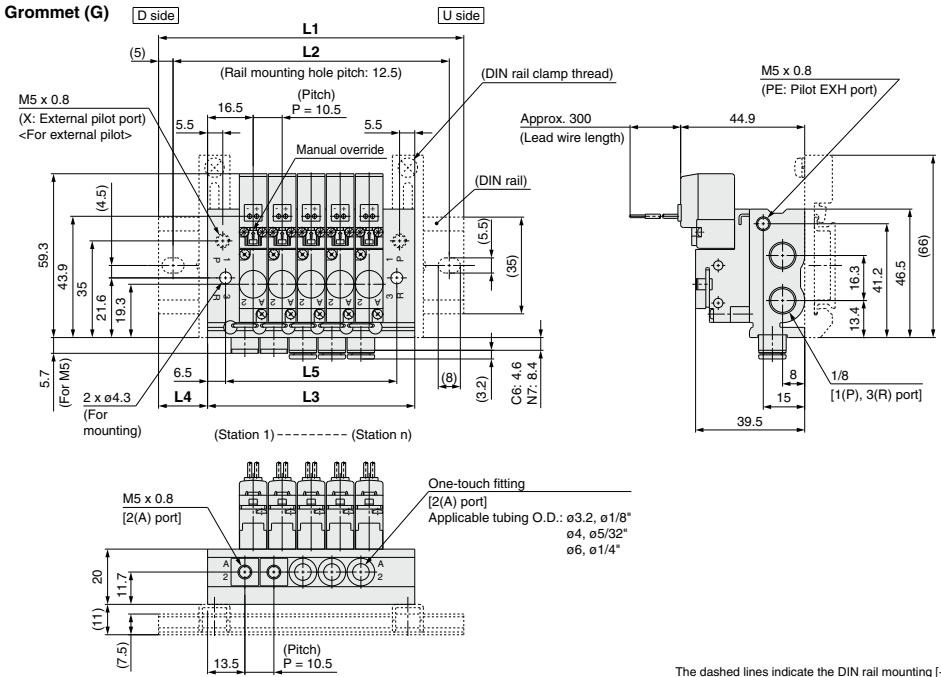

### L-type plug connector (L)

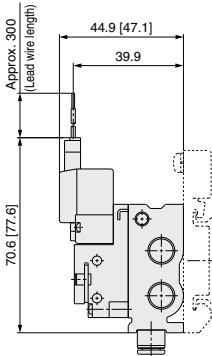

Unless otherwise indicated, dimensions are the same as Grommet (G).  
[ ]: AC

### M-type plug connector (M)

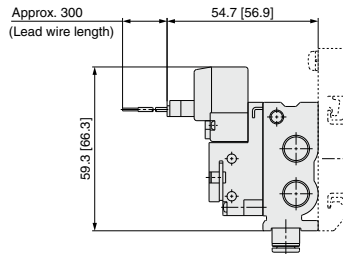

Unless otherwise indicated, dimensions are the same as Grommet (G).  
[ ]: AC

### Dimensions

| L  | n: Stations (Max. 20 stations) |      |      |       |       |       |       |       |       |       |       |       |       |       |       |       |       |       |       |    |
|----|--------------------------------|------|------|-------|-------|-------|-------|-------|-------|-------|-------|-------|-------|-------|-------|-------|-------|-------|-------|----|
|    | 1                              | 2    | 3    | 4     | 5     | 6     | 7     | 8     | 9     | 10    | 11    | 12    | 13    | 14    | 15    | 16    | 17    | 18    | 19    | 20 |
| L1 | 85.5                           | 85.5 | 98   | 110.5 | 123   | 135.5 | 148   | 148   | 160.5 | 173   | 185.5 | 198   | 210.5 | 210.5 | 223   | 235.5 | 248   | 260.5 | 273   |    |
| L2 | 75                             | 75   | 87.5 | 100   | 112.5 | 125   | 137.5 | 137.5 | 150   | 162.5 | 175   | 187.5 | 200   | 200   | 212.5 | 225   | 237.5 | 250   | 262.5 |    |
| L3 | 43.5                           | 54   | 64.5 | 75    | 85.5  | 96    | 106.5 | 117   | 127.5 | 138   | 148.5 | 159   | 169.5 | 180   | 190.5 | 201   | 211.5 | 222   | 232.5 |    |
| L4 | 21                             | 16   | 17   | 18    | 19    | 20    | 21    | 15.5  | 16.5  | 17.5  | 18.5  | 19.5  | 20.5  | 15.5  | 16.5  | 17.5  | 18.5  | 19.5  | 20.5  |    |
| L5 | 30.5                           | 41   | 51.5 | 62    | 72.5  | 83    | 93.5  | 104   | 114.5 | 125   | 135.5 | 146   | 156.5 | 167   | 177.5 | 188   | 198.5 | 209   | 219.5 |    |

# VQZ100/200/300 Series

## Dimensions: VQZ200

VV3QZ25- Stations Port size C

### Grommet (G)

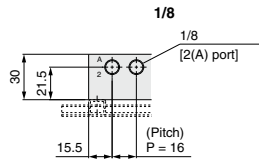
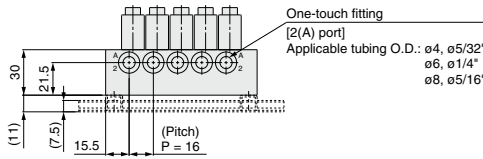
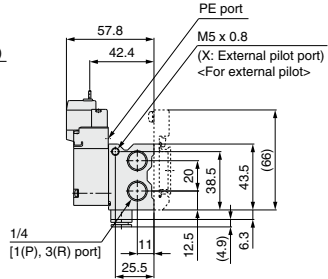
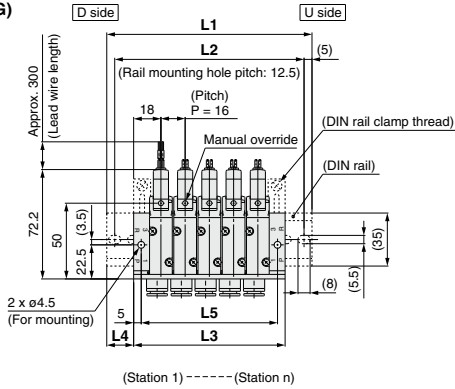

The dashed lines indicate the DIN rail mounting [-D].

### L-type plug connector (L)

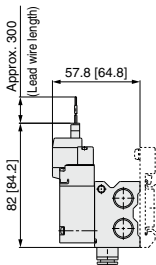

Unless otherwise indicated, dimensions are the same as Grommet (G).  
[ ] : AC

### M-type plug connector (M)

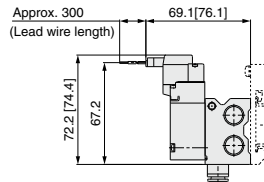

Unless otherwise indicated, dimensions are the same as Grommet (G).  
[ ] : AC

### DIN terminal (Y)

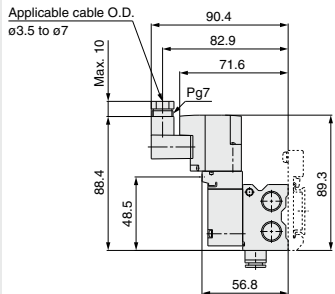

Unless otherwise indicated, dimensions are the same as Grommet (G).

### Dimensions

| n  | 2    | 3    | 4     | 5     | 6     | 7     | 8     | 9     | 10    | 11    | 12    | 13    | 14    | 15    | 16    | 17    | 18    | 19    | 20    |
|----|------|------|-------|-------|-------|-------|-------|-------|-------|-------|-------|-------|-------|-------|-------|-------|-------|-------|-------|
| L1 | 85.5 | 98   | 123   | 135.5 | 148   | 173   | 185.5 | 198   | 210.5 | 235.5 | 248   | 260.5 | 285.5 | 298   | 310.5 | 323   | 348   | 360.5 | 373   |
| L2 | 75   | 87.5 | 112.5 | 125   | 137.5 | 162.5 | 175   | 187.5 | 200   | 225   | 237.5 | 250   | 275   | 287.5 | 300   | 312.5 | 337.5 | 350   | 362.5 |
| L3 | 52   | 68   | 84    | 100   | 116   | 132   | 148   | 164   | 180   | 196   | 212   | 228   | 244   | 260   | 276   | 292   | 308   | 324   | 340   |
| L4 | 17   | 15   | 19.5  | 18    | 16    | 20.5  | 19    | 17    | 15.5  | 20    | 18    | 16.5  | 21    | 19    | 17.5  | 15.5  | 20    | 18.5  | 16.5  |
| L5 | 42   | 58   | 74    | 90    | 106   | 122   | 138   | 154   | 170   | 186   | 202   | 218   | 234   | 250   | 266   | 282   | 298   | 314   | 330   |

n: Stations (Max. 20 stations)



## Dimensions: VQZ300

VV3QZ35- Stations Port size C

### Grommet (G)

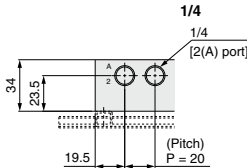
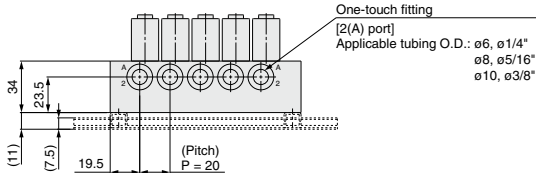
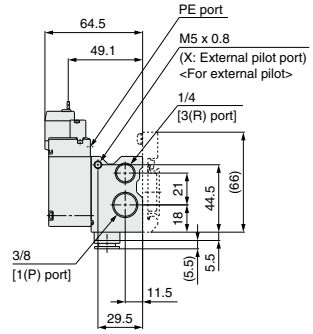
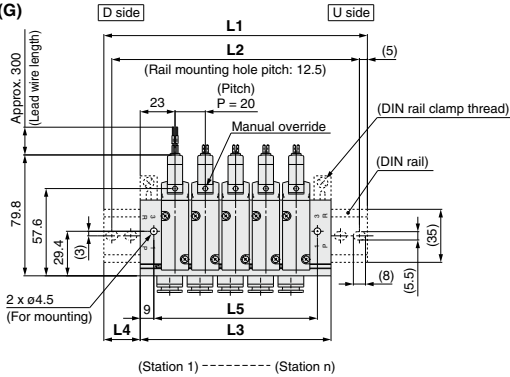

The dashed lines indicate the DIN rail mounting [-D].

### L-type plug connector (L)

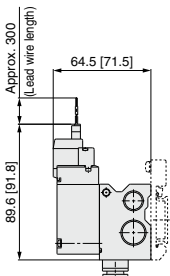

Unless otherwise indicated, dimensions are the same as Grommet (G).  
[-]: AC

### M-type plug connector (M)

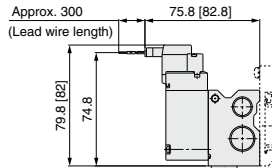

Unless otherwise indicated, dimensions are the same as Grommet (G).  
[-]: AC

### DIN terminal (Y)

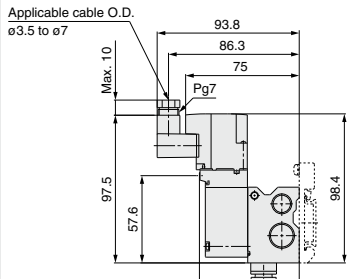

Unless otherwise indicated, dimensions are the same as Grommet (G).

### Dimensions

| n  | 2    | 3     | 4     | 5     | 6     | 7     | 8     | 9     | 10    | 11    | 12    | 13    | 14    | 15    | 16    | 17    | 18    | 19    | 20    |
|----|------|-------|-------|-------|-------|-------|-------|-------|-------|-------|-------|-------|-------|-------|-------|-------|-------|-------|-------|
| L1 | 98   | 123   | 148   | 160.5 | 185.5 | 198   | 223   | 248   | 260.5 | 285.5 | 298   | 323   | 348   | 360.5 | 385.5 | 398   | 423   | 448   | 460.5 |
| L2 | 87.5 | 112.5 | 137.5 | 150   | 175   | 187.5 | 212.5 | 237.5 | 250   | 275   | 287.5 | 312.5 | 337.5 | 350   | 375   | 387.5 | 412.5 | 437.5 | 450   |
| L3 | 66   | 86    | 106   | 126   | 146   | 166   | 186   | 206   | 226   | 246   | 266   | 286   | 306   | 326   | 346   | 366   | 386   | 406   | 426   |
| L4 | 16   | 18.5  | 21    | 17.5  | 20    | 16    | 18.5  | 21    | 17.5  | 20    | 16    | 18.5  | 21    | 17.5  | 20    | 16    | 18.5  | 21    | 17.5  |
| L5 | 48   | 68    | 88    | 108   | 128   | 148   | 168   | 188   | 208   | 228   | 248   | 268   | 288   | 308   | 328   | 348   | 368   | 388   | 408   |

n: Stations (Max. 20 stations)

# VQZ100/200/300 Series

## Manifold Options

### Blanking plate assembly

VVQZ100-10A-5 (for VQZ100)

VVQZ200-10A-5 (for VQZ200)

VVQZ300-10A-5 (for VQZ300)

It is used by attaching on the manifold block for being prepared for removing a valve for maintenance reasons or planning to mount a spare valve, etc.

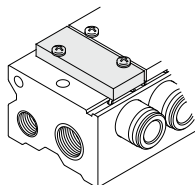

### Blanking plug

KQ2P-23

KQ2P-04

KQ2P-06

KQ2P-08

KQ2P-10

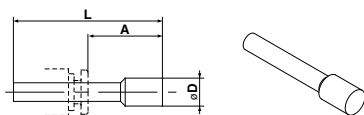

#### Dimensions (mm)

| Applicable fitting size $\phi d$ | Model          | A    | L    | D  |
|----------------------------------|----------------|------|------|----|
| 3.2                              | <b>KQ2P-23</b> | 16   | 31.5 | 5  |
| 4                                | <b>KQ2P-04</b> | 16   | 32   | 6  |
| 6                                | <b>KQ2P-06</b> | 18   | 35   | 8  |
| 8                                | <b>KQ2P-08</b> | 20.5 | 39   | 10 |
| 10                               | <b>KQ2P-10</b> | 22   | 43   | 12 |

### DIN rail

AXT100-DR-□

\* As for □, enter the number from the DIN rail dimensions table.  
For L dimension, refer to the dimensions of each kit.

Each manifold can be mounted on a DIN rail.

Insert "D" at the end of the manifold part number.

The DIN rail is approximately 30 mm longer than the length of manifold.

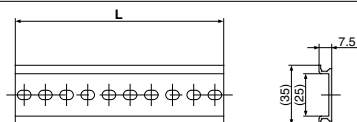

#### L Dimension

|             |     |       |     |       |     |       |     |       |     |       |     |       |     |       |     |       |     |       |     |       |
|-------------|-----|-------|-----|-------|-----|-------|-----|-------|-----|-------|-----|-------|-----|-------|-----|-------|-----|-------|-----|-------|
| No.         | 1   | 2     | 3   | 4     | 5   | 6     | 7   | 8     | 9   | 10    | 11  | 12    | 13  | 14    | 15  | 16    | 17  | 18    | 19  | 20    |
| L dimension | 23  | 35.5  | 48  | 60.5  | 73  | 85.5  | 98  | 110.5 | 123 | 135.5 | 148 | 160.5 | 173 | 185.5 | 198 | 210.5 | 223 | 235.5 | 248 | 260.5 |
| No.         | 21  | 22    | 23  | 24    | 25  | 26    | 27  | 28    | 29  | 30    | 31  | 32    | 33  | 34    | 35  | 36    | 37  | 38    | 39  | 40    |
| L dimension | 273 | 285.5 | 298 | 310.5 | 323 | 335.5 | 348 | 360.5 | 373 | 385.5 | 398 | 410.5 | 423 | 435.5 | 448 | 460.5 | 473 | 485.5 | 498 | 510.5 |

### Silencer

(for manifold EXH port)

Silencer is installed in the manifold EXH port.

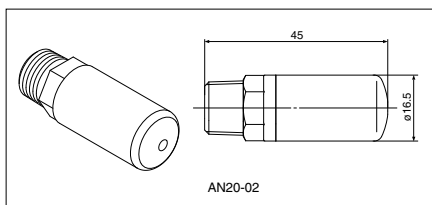
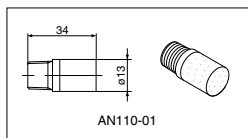

#### Dimensions

| Model         | Silencer part no. |
|---------------|-------------------|
| <b>VQZ100</b> | AN110-01          |
| <b>VQZ200</b> | AN20-02           |
| <b>VQZ300</b> | AN20-02           |

### Port plug

VVQZ100-CP (for VQZ100)

This is used when changing piping location. (Side or Top)



## External Pilot Specification

The external pilot specification is used when the operating pressure is below the minimum operating pressure 0.1 to 0.15 MPa or when valve is used for a vacuum application. Order a valve by adding the external pilot specification [R] to the part number.

Valve Part No.



• Entry is the same as standard products.

Manifold Part No.



• Entry is the same as standard products.

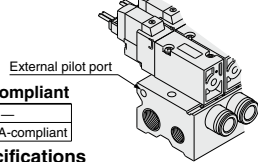

• CE/UKCA-compliant

|     |                   |
|-----|-------------------|
| Nil | —                 |
| Q   | CE/UKCA-compliant |

## Pressure Specifications

| Series   |                              | VQZ100 <small>Note 2)</small> | VQZ200/300      |
|--|------------------------------|-------------------------------|-----------------|
| External pilot pressure range <small>Note 1)</small> | Metal seal                   | —                             | 0.1 to 0.7 MPa  |
|  | Rubber seal (VQZ100: poppet) | 0.2 to 0.7 MPa                | 0.15 to 0.7 MPa |
| Operating pressure range <small>Note 1)</small>      |                              | -100 kPa to 0.7 MPa           |                 |

Note 1) In case of the high pressure type, upper limit of max. operating pressure and external pilot pressure range is 1 MPa.

Note 2) When using the VQZ100 series for a vacuum application, vacuum air through its 1(P) port. When supplying vacuum-release air, supply it through its 3(R) port. But do not supply vacuum-release air exceeding 50% for the external pilot pressure.

In addition, when the VQZ100 is to be used at an operating pressure greater than 0.2 MPa, please assure that the operating pressure is set to equal to or less than the external pilot pressure.

## Inch Size One-touch Fittings and Optional Threads

Inch size One-touch fittings and NPT, NPTF and G thread are available.

Manifold Part No.



• Entry is the same as standard products.

• Cylinder port

• CE/UKCA-compliant

|     |                   |
|-----|-------------------|
| Nil | —                 |
| Q   | CE/UKCA-compliant |

• Thread type (Cylinder port and 1(P), 3(R) ports)

| Symbol                 | N1     | N3     | N7    | N9     | N11   | NM <small>Note 1)</small> | M5        | O1         | O2         |
|------------------------|--------|--------|-------|--------|-------|---------------------------|-----------|------------|------------|
| Applicable tubing O.D. | ø1/8"  | ø5/32" | ø1/4" | ø5/16" | ø3/8" | Mixed                     | M5 thread | 1/8 thread | 1/4 thread |
| Cylinder port          | VQZ100 | ●      | ●     | ●      | —     | —                         | ●         | —          | —          |
|                        | VQZ200 | —      | —     | ●      | ●     | —                         | —         | ●          | —          |
|                        | VQZ300 | —      | —     | —      | ●     | ●                         | —         | —          | ●          |

Note 1) Except VQZ100, mixing One-touch fittings and thread types is impossible.

Note 2) Metric size One-touch fittings (C□) are also available.

|     |      |
|-----|------|
| Nil | Rc   |
| N   | NPT  |
| T   | NPTF |
| F   | G    |

## Optional Threads Other than Rc

Rc specifications are standard for all ports, however, NPT, NPTF and G are available for overseas markets. Add the appropriate symbol following the port size in the standard part number.

Valve Part No.



• Entry is the same as standard products.

• CE/UKCA-compliant

|     |                   |
|-----|-------------------|
| Nil | —                 |
| Q   | CE/UKCA-compliant |

• Thread type (Cylinder port and 1(P), 3(R) ports of sub-plate)

|     |      |
|-----|------|
| Nil | Rc   |
| N   | NPT  |
| T   | NPTF |
| F   | G    |

## IP65 Enclosure (Based on IEC60529)

DIN terminal is available with IP65 enclosure.

Valve Part No.

(Applicable to the VQZ200/300 rubber seal with the exception of the external pilot type)



• Entry is the same as standard products.

Note) The pilot exhaust IP65 valves is common with main valve exhaust. (The standard valve has an individual exhaust for the pilot valve.)

• CE/UKCA-compliant

|     |                   |
|-----|-------------------|
| Nil | —                 |
| Q   | CE/UKCA-compliant |

# VQZ Series Base Mounted

## Replacement Parts

### One-touch Fitting Assembly (for Cylinder port)

| Fitting size  | C3             | C4             | C6             | C8             | C10             | M5 (VQZ100 only) |
|---------------|----------------|----------------|----------------|----------------|-----------------|------------------|
| <b>VQZ100</b> | VVQ1000-50A-C3 | VVQ1000-50A-C4 | VVQ1000-50A-C6 | —              | —               | VVQ1000-50A-M5   |
| <b>VQZ200</b> | —              | VVQ1000-51A-C4 | VVQ1000-51A-C6 | VVQ1000-51A-C8 | —               | —                |
| <b>VQZ300</b> | —              | —              | VVQ2000-51A-C6 | VVQ2000-51A-C8 | VVQ2000-51A-C10 | —                |

Note) Purchasing order is available in units of 10 pieces.

#### <Plug connector assembly>

DC: SY100-30-4A-□

100 VAC: SY100-30-1A-□

200 VAC: SY100-30-2A-□

Other AC voltages: SY100-30-3A-□

Without lead wire: SY100-30-A  
(with connector and 2 sockets only)

#### Lead wire length

|     |         |
|-----|---------|
| Nil | 300 mm  |
| 6   | 600 mm  |
| 10  | 1000 mm |
| 15  | 1500 mm |
| 20  | 2000 mm |
| 25  | 2500 mm |
| 30  | 3000 mm |
| 50  | 5000 mm |

#### How to Order

Include the connector assembly part number together with the part number for the plug connector's solenoid valve without connector.

Example) In case of 2000 mm of lead wire

| DC             | AC             |
|----------------|----------------|
| VQZ115-SLO1-M5 | VQZ115-1LO1-M5 |
| SY100-30-4A-20 | SY100-30-1A-20 |

#### <Gasket and screw assembly>

| Model         | Part no.    |
|---------------|-------------|
| <b>VQZ100</b> | VQZ100-GS-5 |
| <b>VQZ200</b> | VQZ200-GS-5 |
| <b>VQZ300</b> | VQZ300-GS-5 |

Note) The above part numbers are for 10 valves (a set of 10 gaskets and 20 screws).

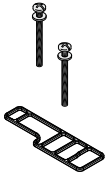

#### <Sub-plate>

| Model         | Sub-plate part no. |                     |
|---------------|--------------------|---------------------|
|               | For internal pilot | For external pilot  |
| <b>VQZ100</b> | VQZ100-S-01□(-Q)   | VQZ100-S-01□(-R(-Q) |
| <b>VQZ200</b> | VQZ200-S-01□(-Q)   | VQZ200-S-01□(-R(-Q) |
| <b>VQZ300</b> | VQZ300-S-02□(-Q)   | VQZ300-S-02□(-R(-Q) |

\* Thread type

#### <Pilot valve assembly>

V111 □ □ — 5 G □ □

#### Function

| Symbol                        | Specifications   | DC                             | AC                    |
|-------------------------------|--|--------------------------------|-----------------------|
| <b>Nil</b>                    | Standard   | (0.35 W) <input type="radio"/> | <input type="radio"/> |
| <b>B</b> <small>Note)</small> | High speed response type (Applicable to VQZ200/300)                  | (0.9 W) <input type="radio"/>  | —                     |
| <b>K</b> <small>Note)</small> | High pressure type (Applicable to Metal seal type, Poppet seal type) | (0.9 W) <input type="radio"/>  | —                     |

Note) Semi-standard

#### Manual override

|            |                                 |
|------------|---------------------------------|
| <b>Nil</b> | None (Applicable to VQZ200/300) |
| <b>M</b>   | Yes (Applicable to VQZ100)      |

#### Manual override (Applicable to the VQZ100)

|            |                       |
|------------|-----------------------|
| <b>Nil</b> | Non-locking push type |
| <b>B</b>   | Locking slotted type  |

#### Coil voltage

|   |                              |
|---|------------------------------|
| 1 | 100 VAC (50/60 Hz)           |
| 2 | 200 VAC (50/60 Hz)           |
| 3 | 110 VAC (115 VAC) (50/60 Hz) |
| 4 | 220 VAC (230 VAC) (50/60 Hz) |
| 5 | 24 VDC                       |
| 6 | 12 VDC                       |

#### Electrical entry

| Symbol     | DC         | AC | Electrical entry                        | Light/surge voltage suppressor |
|------------|------------|----|---|--------------------------------|
| <b>G</b>   | —          | —  | Grommet (DC specification)              | None                           |
| <b>LU</b>  | <b>LZ</b>  | —  | L-type plug connector with lead wire    | Yes                            |
| <b>LOU</b> | <b>LOZ</b> | —  | L-type plug connector without connector |                                |
| <b>MU</b>  | <b>MZ</b>  | —  | M-type plug connector with lead wire    |                                |
| <b>MOU</b> | <b>MOZ</b> | —  | M-type plug connector without connector |                                |

Note) The electrical entry (L, M) for the VQZ100 pilot valve is different from that of the main valve model number.

| Valve model  | Pilot valve model |
|--------------|-------------------|
| VQZ115□-□L□1 | V111□M-□M□        |
| VQZ115□-□M□1 | V111□M-□L□        |

#### <DIN terminal type (Applicable to the VQZ200/300)>

V115 □ □ — 5 Y — X110

#### Function

| Symbol                        | Specifications                            | DC                             | AC                    |
|-------------------------------|---|--------------------------------|-----------------------|
| <b>Nil</b>                    | Standard                                  | (0.35 W) <input type="radio"/> | <input type="radio"/> |
| <b>B</b> <small>Note)</small> | High speed response type                  | (0.9 W) <input type="radio"/>  | —                     |
| <b>K</b> <small>Note)</small> | High pressure type (Metal seal type only) | (0.9 W) <input type="radio"/>  | —                     |

Note) Semi-standard

#### Coil voltage

|   |                              |
|---|------------------------------|
| 1 | 100 VAC (50/60 Hz)           |
| 2 | 200 VAC (50/60 Hz)           |
| 3 | 110 VAC (115 VAC) (50/60 Hz) |
| 4 | 220 VAC (230 VAC) (50/60 Hz) |
| 5 | 24 VDC                       |
| 6 | 12 VDC                       |

#### Electrical entry

| Symbol                          | Electrical entry   | Light/surge voltage suppressor |
|---------------------------------|--|--------------------------------|
| <b>Y</b>                        | DIN terminal   | None                           |
| <b>YO</b>                       | DIN terminal without connector   |                                |
| <b>YZ</b>                       | DIN terminal with light/surge voltage suppressor                                 | Yes                            |
| <b>YS</b> <small>Note)</small>  | DIN terminal with surge voltage suppressor (DC specification)                    | Yes                            |
| <b>YOS</b> <small>Note)</small> | DIN terminal with surge voltage suppressor, without connector (DC specification) | (Without light)                |

Note) For AC voltage valves there is no "S" option. It is already built-in to the rectifier circuit.

### ⚠ Caution

When replacing only the pilot valve assembly, use caution because it is not possible to convert to a V115 (DIN terminal) from a V111 (Grommet, L-type, M-type), or vice versa.

# VQZ200/300 Series

## Made to Order

Please contact SMC for detailed dimensions, specifications and lead times.



### 1 Pilot Valve Common Exhaust Specification

Pilot exhaust is exhausted through the main R port.

- \* Not designed to prevent leakage to outside.
- \* A combination of external pilots is not available.
- \* "How to Order Manifold" is the same as standard products. Please specify this to "How to Order Valve."

Applicable solenoid valve series: VQZ200/300

#### How to Order

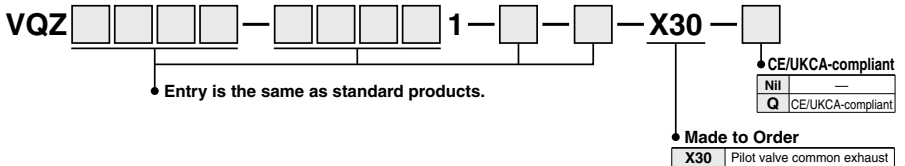

### 2 Main Valve Fluororubber Specification

The seal material, the part of the main valve in contact with fluid, is made of fluororubber.

- \* "How to Order Manifold" is the same as standard products. Please specify this to "How to Order Valve."

Applicable solenoid valve series: VQZ200/300

#### How to Order

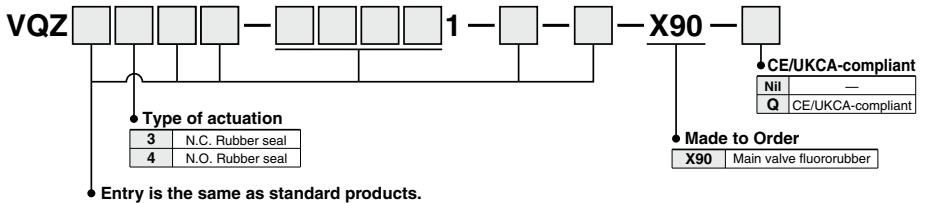

### 3 All Fluororubber Specification

The rubber material of the part in contact with fluid, is made of fluororubber.

- \* "How to Order Manifold" is the same as standard products. Please specify this to "How to Order Valve."

Applicable solenoid valve series: VQZ200/300

#### How to Order

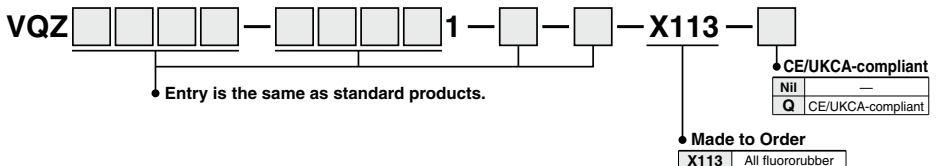



# VQZ Series

## Specific Product Precautions 1

Be sure to read this before handling the products.

Refer to page 8 for safety instructions and pages 9 to 15 for 3/4/5 port solenoid valve precautions.

### Manual Override

#### ⚠ Caution

Without an electric signal for the solenoid valve the manual override is used for switching the main valve. Push type is standard. Locking type (Tool required) is available as an option.

##### 1. VQZ100

Push type

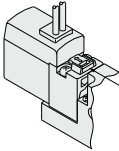

Press in the direction of the arrow.

Locking type (Tool required)

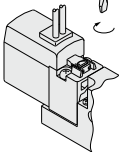

Turn 90° in the direction of arrow.

##### 2. VQZ200/300

Push type (Tool required)

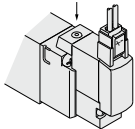

Push down on the manual override button with a small screwdriver until it stops. Release the screwdriver and the manual override will return.

Locking type (Tool required)

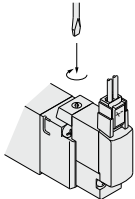

Push down completely on the manual override button with a small screwdriver. While down, turn clockwise 90° to lock it. Turn it counterclockwise to release it.

Locked position

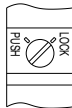

#### Precautions

When operating with a screwdriver, turn it gently using a watchmaker's screwdriver. (Torque: less than 0.1 N·m)  
Press and rotate to lock the manual operation of VQZ200/300. If rotate without pressing, manual breakage and air leakage could be occurred.

### How to Use L/M-Type Plug Connector

#### ⚠ Caution

##### 1. Attaching and detaching connectors

To attach a connector, hold the lever and connector unit between your fingers and insert straight onto the pins of the solenoid valve and remove the pawl from the groove by pushing the lever downward with your thumb, and pull the connector straight out.

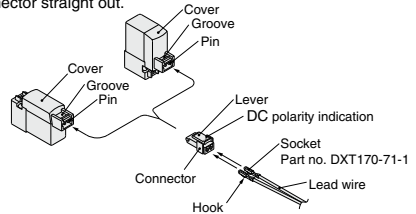

### Light/Surge Voltage Suppressor

#### ⚠ Caution

##### 1. L/M-type plug connector

<DC>

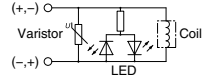

<AC>

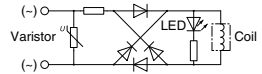

##### 2. DIN terminal

<DC>

With surge voltage suppressor (YS, YOS)

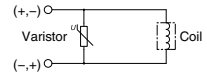

Light/surge voltage suppressor (YZ)

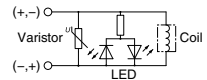

<AC>

With light (YZ)

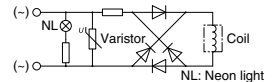

Note) Surge voltage suppressor of varistor has residual voltage corresponding to the protective element and rated voltage; therefore, protect the controller side from the surge.



# VQZ Series

## Specific Product Precautions 2

Be sure to read this before handling the products.

Refer to page 8 for safety instructions and pages 9 to 15 for 3/4/5 port solenoid valve precautions.

### Lead Wire Connection

#### ⚠ Caution

##### 1. Crimping of lead wires and sockets

Not necessary if ordering the lead wire pre-connected model. Strip 3.2 to 3.7 mm at the end of the lead wires, insert the ends of the core wires evenly into the sockets, and then crimp with a crimping tool. When this is done, take care that the coverings of the lead wires do not enter the core wire crimping area.

(Please contact SMC for the crimping tools.)

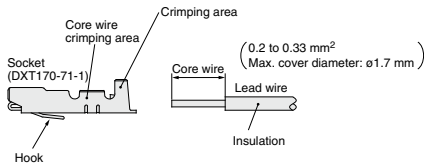

##### 2. Attaching and detaching sockets with lead wires

###### Attaching

Insert the sockets into the square holes of the connector (⊕, ⊖ indication), and continue to push the sockets all the way in until they lock by hooking into the seats in the connector. (When they are pushed in, their hooks open and they are locked automatically.) Then, confirm that they are locked by pulling lightly on the lead wires.

###### Detaching

To detach a socket from a connector, pull out the lead wire while pressing the socket's hook with a stick having a thin tip (approx. 1 mm). If the socket will be used again, first spread the hook outward.

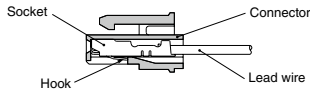

### Pilot Valve Replacement

#### ⚠ Caution

1. When replacing a current type valve with a new type for maintenance or other reasons, a "conversion connector assembly" is necessary to convert the connector from 3 terminals to 2 terminals and must be ordered separately. (When ordering, refer to the below part nos.)

For pilot valves, there is no compatibility between the current type and new type. When replacing a pilot valve, be sure to confirm whether it is the new type or the current type.

##### [Current]

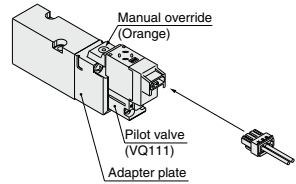

##### [New]

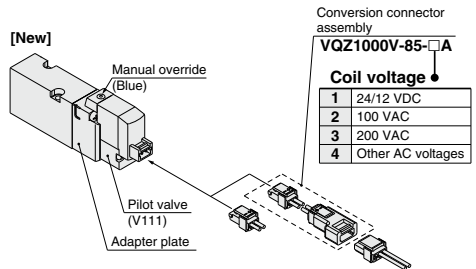

| Conversion connector assembly |                   |
|-------------------------------|-------------------|
| VQZ1000V-85-□A                |                   |
| Coil voltage                  |                   |
| 1                             | 24/12 VDC         |
| 2                             | 100 VAC           |
| 3                             | 200 VAC           |
| 4                             | Other AC voltages |



# VQZ Series

## Specific Product Precautions 3

Be sure to read this before handling the products.

Refer to page 8 for safety instructions and pages 9 to 15 for 3/4/5 port solenoid valve precautions.

### How to Use DIN Terminal

#### 1. EN-175301-803C (Former DIN 43650C) (8 mm between pins)

The DIN terminal type with an IP65 enclosure is protected against dust and water, however, it must not be used in water.

#### 2. Connection

- 1) Loosen the holding screw and pull the connector out of the solenoid valve terminal block.
- 2) After removing the holding screw, insert a flat head screwdriver, etc. into the notch on the bottom of the terminal block and pry it open, separating the terminal block and the housing.
- 3) Loosen the terminal screws (slotted screws) on the terminal block, insert the cores of the lead wires into the terminals according to the connection method, and fasten them securely with the terminal screws.
- 4) Secure the cord by fastening the ground nut.

#### 3. Changing the entry direction

After separating the terminal block and housing, the cord entry can be changed by attaching the housing in the desired direction (4 directions at 90° intervals).

\* When equipped with a light, be careful not to damage the light with the cord's lead wires.

#### 4. Precautions

Plug in and pull out the connector vertically without tilting to one side.

#### 5. Compatible cable

Cable O.D.:  $\phi 3.5$  to  $\phi 7$   
(Reference) 0.5 mm<sup>2</sup>, 2-core or 3-core, equivalent to JIS C 3306

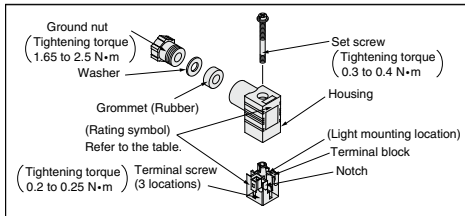

### DIN Connector Part No.

#### Without light

| Rated voltage | Voltage symbol | Part no.   |
|---------------|----------------|------------|
| All voltages  | None           | SY100-82-1 |

#### With light

| Rated voltage     | Voltage symbol | Part no.      |
|-------------------|----------------|---------------|
| 24 VDC            | 24 V           | SY100-82-3-05 |
| 12 VDC            | 12 V           | SY100-82-3-06 |
| 100 VAC           | 100 V          | SY100-82-2-01 |
| 200 VAC           | 200 V          | SY100-82-2-02 |
| 110 VAC (115 VAC) | 110 V          | SY100-82-2-03 |
| 220 VAC (230 VAC) | 220 V          | SY100-82-2-04 |

### Circuit diagram with light

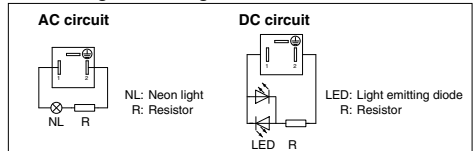

### Fitting and Silencer Part No. for P, R Ports When Using Valve as an Individual Unit

Part no. for one-touch fitting for 1(P) port and silencer/one-touch fitting for 3(R) port

| Series | (1) One-touch fitting for 1(P) port | (2) For 3(R) port |                            |
|--------|-------------------------------------|-------------------|----------------------------|
|        |                                     | Silencer          | One-touch fitting          |
| VQZ100 | KQ2H06-M5A                          | AN120-M5          | KJS04-M5A                  |
| VQZ200 | KQ2S06-01AS                         | INA-25-46         | IN-457-32L (for $\phi 6$ ) |
| VQZ300 | KQ2H08-02AS                         | AN101-01          | KQ2H06-01AS                |

The diameter of the above fitting and silencer is the maximum diameter to in the EXH port.

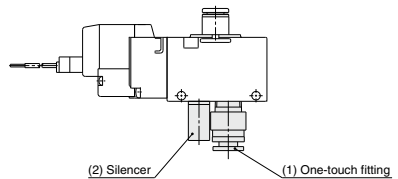





# VQZ Series

## Specific Product Precautions 4

Be sure to read this before handling the products.

Refer to page 8 for safety instructions and pages 9 to 15 for 3/4/5 port solenoid valve precautions.

### One-touch Fittings Replacement

#### ⚠ Caution

The built-in fittings on the manifold can be changed easily. Simply remove the corresponding valve and take out the fitting clip underneath.

Take out the clip with a screwdriver, etc., then replace the fittings. About mounting the fittings, after inserting the fitting until it stops, then put the clip into the prescribed position.

VQZ200: Horizontally clipped to the valve body

VQZ100/300: Vertically clipped to the valve body

#### ■ Valve

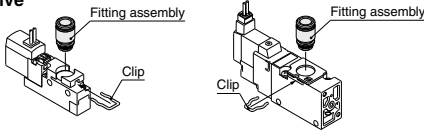

#### Valve Clip Part No. (10 pcs. included)

| Series | Part number |
|--------|-------------|
| VQZ100 | VQZ100-2-FC |
| VQZ200 | VQZ200-2-FC |
| VQZ300 | VQZ300-2-FC |

#### ■ Manifold base

#### Base Clip Part No. (10 pcs. included)

| Series  | Part number |
|---------|-------------|
| VV3QZ15 | VQZ100-5-FC |
| VV3QZ25 | VQZ200-5-FC |
| VV3QZ35 | VQZ300-5-FC |

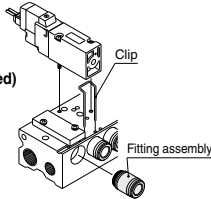

#### Precautions

When pulling the fitting assembly away from the valve base, remove the clip, then connect a tube or plug (KQ2P-□□) with the One-touch fitting and pull it out holding the tube or plug. Do not hold the release bushing to avoid damage.

### DIN Rail Removal/Mounting

#### ⚠ Caution

#### 1. Removing

- Loosen the clamp screw on the (a) side of both ends of the manifold.
- Lift the (a) side of the manifold off the DIN rail and slide it in the direction of the (b) side.

#### 2. Mounting

- Catch the hook of the DIN rail bracket on the (b) side on the DIN rail.
- Push side (a) onto the DIN rail and tighten the clamp screw. The proper tightening torque for screws is 0.3 to 0.4 N·m.

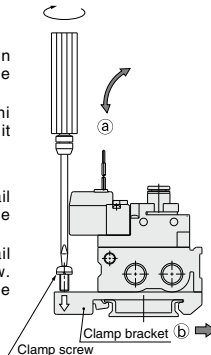

### Valve Mounting

#### ⚠ Caution

- After confirming the gasket is correctly placed under the valve, securely tighten the bolts with the proper torque shown in the table below.

| Model  | Proper tightening torque |
|--------|--------------------------|
| VQZ100 | 0.13 to 0.19 N·m         |
| VQZ200 | 0.25 to 0.35 N·m         |
| VQZ300 | 0.5 to 0.7 N·m           |

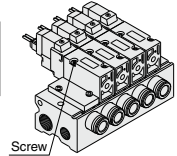

### VQZ100 Piping Direction Replacement

#### ⚠ Caution

#### 1. How to replace the port direction

Fitting and port plug are modules. After removing the clip with a flat head screwdriver, take out the fitting and port plug. The piping direction (side or top) can be altered by exchanging the fitting and port plug. During exchange, insert the fitting and the port plug until they contact the wall, then, insert the clip to specified position.

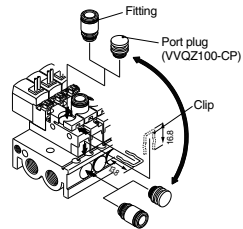

#### Precautions

The clip length for the valve and the base are different. Fitting may detach if the incorrect clip is used.

#### 2. Valve piped on top can be operated independently by using PR plate.

(Refer to the below part numbers when placing an order.)

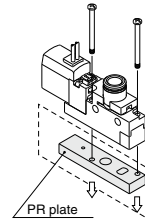

VQZ100-12A (Standard)  
VQZ100-12B (External pilot type)

\* 2 set screws are included.