





Precision Regulator

IR1000/2000/3000 Series

The precision regulator IR series has been remodeled.
Please select the [new IR□-A series](#) instead.

	Series	Model	Set pressure range	Port size	Page
Basic Type	IR1000 Series 	IR1000	0.005 to 0.2 MPa	1/8	1099
		IR1010	0.01 to 0.4 MPa		
		IR1020	0.01 to 0.8 MPa		
	IR2000 Series 	IR2000	0.005 to 0.2 MPa	1/4	1099
		IR2010	0.01 to 0.4 MPa		
		IR2020	0.01 to 0.8 MPa		
	IR3000 Series 	IR3000	0.01 to 0.2 MPa	1/4, 3/8, 1/2	1099
		IR3010	0.01 to 0.4 MPa		
		IR3020	0.01 to 0.8 MPa		

Air Operated Type	IR2000 Series 	IR2120	0.01 to 0.8 MPa	1/4	1099
	IR3000 Series 	IR3120	0.01 to 0.8 MPa	1/4, 3/8, 1/2	1099

Precision Regulator

IR1000/2000/3000 Series

Bracket and pressure gauge can be mounted from 2 directions

Mounting is possible on either the front or the back.

Expanded set pressure range

The maximum set pressure has been expanded from the current 0.7 MPa to 0.8 MPa.

Compact and lightweight

IR1000 width 35 mm weight 140 g
IR2000 width 50 mm weight 300 g
IR3000 width 66 mm weight 640 g

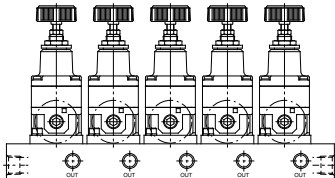
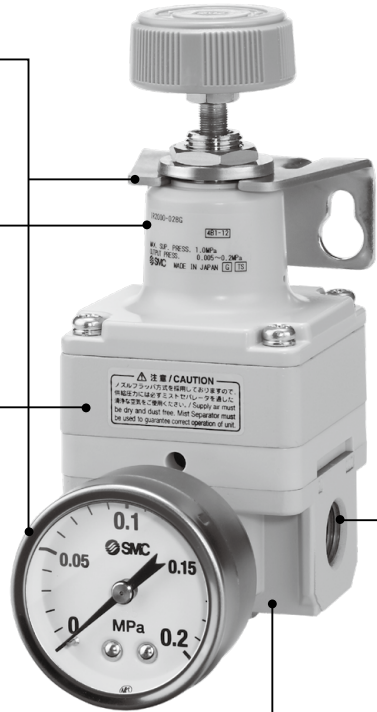

Manifolding is possible 8 stations at the maximum

Made to order specifications
(Except IR2120, IR3000 series)

Compatible with new modular connection brackets (-X170)

Can be combined with AF (Air filter) and AFM (Mist separator).

Modular adapter



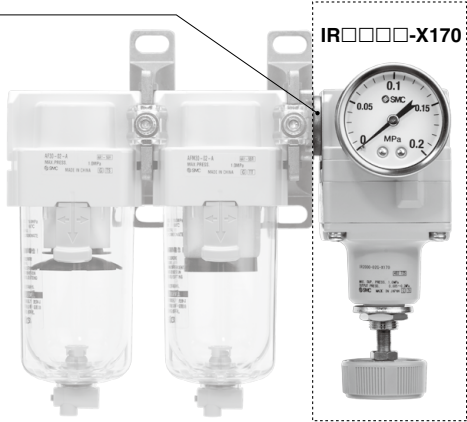

Applicable modular size **IR1000 series:** 20 type
IR2000 series: 30 type
IR3000 series: 40 type

*1 The Made-to-Order product (IR□□□□-X170) is the product number with a modular adapter attached to the standard product. Attaching a modular adapter enables a connection to the new modular connection brackets (Y200-A/Y300-A/Y400-A).

*2 Air filter, mist separator, interface with bracket, etc. are not included. Order them separately.

Relief flow rate characteristics

Possible to relieve (exhaust) air ranged 50 to 4000 L/min (ANR)

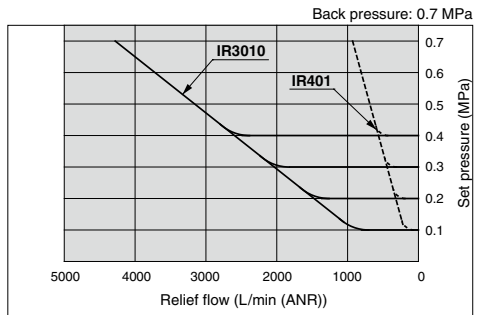
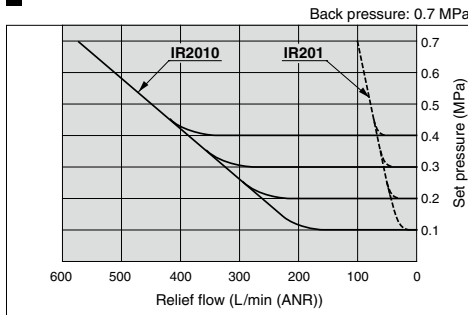

Series Variations

Specifications		Model	Basic type			Air operated type	
		IR10□0	IR20□0	IR30□0	IR2120	IR3120	
Maximum set pressure	0.2 MPa	●	●	●	—	—	
	0.4 MPa	●	●	●	—	—	
	0.8 MPa	●	●	●	●	●	
Port size	Rc 1/8	●	—	—	—	—	
	Rc 1/4	—	●	●	●	●	
	Rc 3/8	—	—	●	—	●	
	Rc 1/2	—	—	●	—	●	

Made to Order Specifications

Symbol	Specifications/Content
10-	Clean Series
25A-	Secondary battery compatible
80-	Ozone resistant
-T	For high temperature
-L	For low temperature (Except IR1000 series)
-X1 <small>Note1)</small>	Non-grease specifications
-X170	Compatible with modular connection brackets (With modular adapter)
-X465 □	With digital pressure switch (ISE20/A)
IRM □	Manifold (Except IR2120, IR3000 series)

Note 1) Fluorine grease is used on the following parts:

IR1000 to 2000 series: Part of the non-wetted parts (threaded part on the setting knob)

IR3000 series: Part of the wetted parts (sliding parts) and non-wetted parts (threaded part on the setting knob)

Note 2) For details, refer to page 1108.

Constant fluid pressure

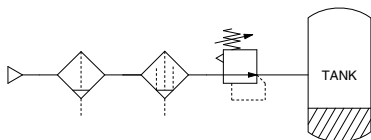

- Since there is a large effective area for supply and exhaust pressure, setting can be done quickly.

Balance and drive Accurate balance pressure setting

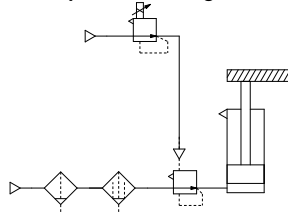

- Limits pressure fluctuation when driving a cylinder, maintaining excellent static and dynamic balance.

Accurate pressure setting — Sensitivity within 0.2% F.S. (Full Span) Tension control

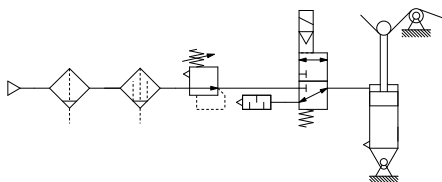

Contact pressure control

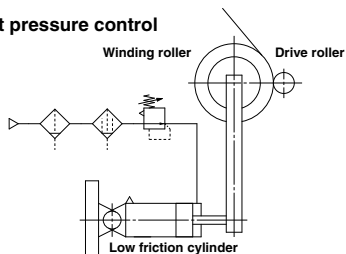

- Adapts to the cylinder's piston displacement, maintaining a constant pressure.

Multistage control of pressing force for workpiece (Wrapping machine)

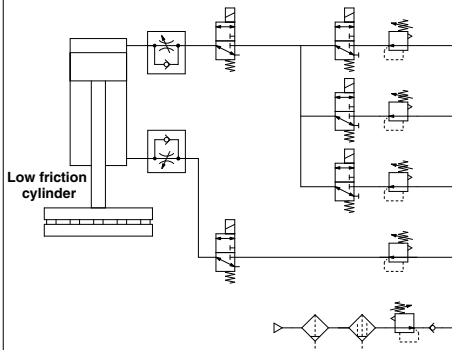

Leak test circuit

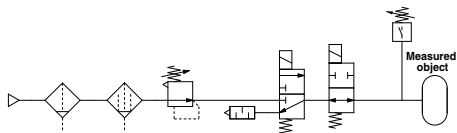

Precision Regulator

IR1000/2000/3000 Series



Standard Specifications

The precision regulator IR series has been remodeled. Please select the [new IR□-A series](#) instead.

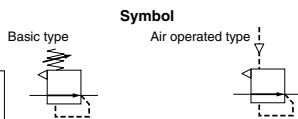

Model	Basic type			Air operated type	
	IR10□0	IR20□0	IR30□0	IR2120	IR3120
Fluid	Air				
Max. supply pressure	Max. 1.0 MPa				
Min. supply pressure (1)	Set pressure + 0.05 MPa		Set pressure + 0.1 MPa	Set pressure + 0.05 MPa	Set pressure + 0.1 MPa
Set pressure range	IR1000: 0.005 to 0.2 MPa IR1010: 0.01 to 0.4 MPa IR1020: 0.01 to 0.8 MPa	IR2000: 0.005 to 0.2 MPa IR2010: 0.01 to 0.4 MPa IR2020: 0.01 to 0.8 MPa	IR3000: 0.01 to 0.2 MPa IR3010: 0.01 to 0.4 MPa IR3020: 0.01 to 0.8 MPa	0.01 to 0.8 MPa	0.01 to 0.8 MPa
Input signal (2) pressure	—			0.01 to 0.8 MPa	0.01 to 0.8 MPa
Sensitivity (3)	Within 0.2% of full span				
Repeatability (3)	Within ±0.5% of full span				
Linearity (4)	—			Within ±1% of full span	
Air consumption (5) (At supply pressure of 1.0 MPa)	4.4 L/min (ANR) or less	4.4 L/min (ANR) or less	11.5 L/min (ANR) or less	4.4 L/min (ANR) or less	11.5 L/min (ANR) or less
Port size	Rc 1/8	Rc 1/4	Rc 1/4, 3/8, 1/2	Rc 1/4	Rc 1/4, 3/8, 1/2
Pressure gauge port	Rc 1/8 (2 locations)				
Ambient and fluid temperature	-5 to 60°C (No freezing)				
Weight (kg)	0.14	0.30	0.64	0.35	0.71

Note 1) With the condition of no flow on the output side. Together with the set pressure, be sure to maintain a minimum differential pressure of 0.05 MPa for IR1000 and IR2000 series, and 0.1 MPa for IR3000 series.

Note 2) Applicable only to air operated types IR2120 and IR3120. The basic type is excepted.

Note 3) Characteristic values are subject to conditions where other characteristics, such as secular change and temperature change, are not included.

Note 4) Indicates the linearity of the output pressure with respect to the input signal pressure.

Note 5) Air is normally being discharged to the atmosphere from a bleed hole or an exhaust port.

Specification Combinations

⊙: Standard specifications ○: Combination possible □: Combination not possible



Specifications	Symbol	Applicable model				
		IR1000 IR1010 IR1020	IR2000 IR2010 IR2020	IR2120	IR3000 IR3010 IR3020	IR3120
Standard specifications	Set pressure Max. 0.2 MPa	0	⊙	○	○	○
	Set pressure Max. 0.4 MPa	1	⊙	○	○	○
	Set pressure Max. 0.8 MPa	2	⊙	○	○	○
	Connection Rc 1/8	01	⊙	○	○	○
	Connection Rc 1/4	02	□	○	○	○
	Connection Rc 3/8	03	□	○	○	○
Connection Rc 1/2	04	□	○	○	○	
Accessory	Bracket	B	○	○	○	○
	Pressure gauge	G	○	○	○	○
Semi-standard specifications	Bracket, name plate reverse mounted	R	○	○	○	○
	Connection NPT 1/8	N01	○	□	□	□
	Connection NPT 1/4	N02	○	○	○	○
	Connection NPT 3/8	N03	○	□	□	□
	Connection NPT 1/2	N04	○	□	□	□
	Connection G 1/8	F01	○	□	□	□
	Connection G 1/4	F02	□	○	○	○
	Connection G 3/8	F03	□	○	○	○
Connection G 1/2	F04	□	○	○	○	

* Photos are when a pressure gauge is mounted. Pressure gauge is shipped together, but not assembled.

IR1000/2000/3000 Series

How to Order

Made to Order
(Refer to pages 1108 to 1110 for details.)

IR 2 0 0 0 — **02** —

Precision regulator •

Body size •

1	IR1000 series
2	IR2000 series
3	IR3000 series

Type of setting •

0	Basic type (Knob)
1 ^{Note 1)}	Air operated type

Set pressure range •
For IR1000/2000 series

0	0.005 to 0.2 MPa
1	0.01 to 0.4 MPa
2	0.01 to 0.8 MPa

For IR3000 series

0	0.01 to 0.2 MPa
1	0.01 to 0.4 MPa
2	0.01 to 0.8 MPa

Suffix

Nil	—
R ^{Note 4)}	Bracket, Name plate, Mounting on the opposite side

Accessory

Nil	None
B	With bracket
G ^{Note 3)}	With pressure gauge

Port size

Symbol	Size	Application		
		IR1000	IR2000	IR3000
01	1/8	●		
02	1/4		●	●
03	3/8			●
04	1/2			●

Thread type

Nil	Rc
N ^{Note 2)}	NPT
F	G

Note 1) Air operated type is IR2120 and IR3120 only.

Note 2) For thread type NPT, this product is for overseas use only according to the new Measurement Law. (The SI unit type is provided for use in Japan.)

Note 3) For the model with pressure gauge (G), the pressure gauge is shipped together, but not assembled.

Note 4) The standard mounting position of the name plate is on the front when viewing the precision regulator with the SUP side to the left and OUT side to the right. The bracket is attached to the back.

Accessory (Option)/Part No.

Description	Part no.								
	IR1000	IR1010	IR1020	IR2000	IR2010	IR2020/2120	IR3000	IR3010	IR3020/3120
Bracket	P36201023			P36202028			P362030-20 ^{*1}		
^{*2, *3} Pressure gauge Thread type Rc, G	G33-2-01	G33-4-01	G33-10-01	G43-2-01	G43-4-01	G43-10-01	G43-2-01	G43-4-01	G43-10-01
Thread type NPT	G33-P2-N01-X30	G33-P4-N01-X30	G33-P10-N01-X30	G43-P2-N01-X30	G43-P4-N01-X30	G43-P10-N01-X30	G43-P2-N01-X30	G43-P4-N01-X30	G43-P10-N01-X30

*1 A bracket and two mounting screws (M5 x 35)

To mount the bracket, remove two body screws (M5 x 30) on the name plate on the opposite side and replace the attached two bracket mounting screws (M5 x 35).

*2 When ordering this pressure gauge individually, the sealant is not applied to the connection male thread. So, apply the sealing tape or sealant to the screw thread before use.

*3 For handling of the pressure gauge and the detailed specifications, refer to "Pressure Gauges" in the **Web Catalog**.

Construction

IR1000

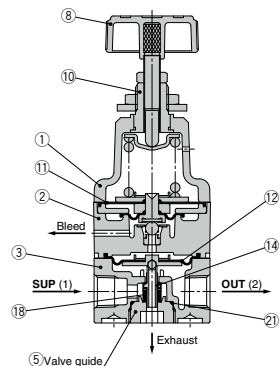
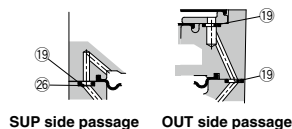

IR2000

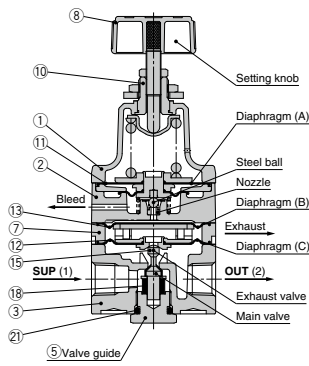
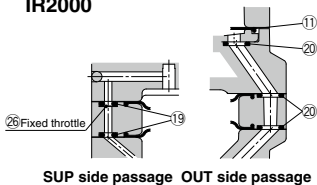

IR3000

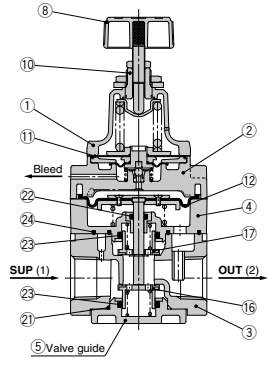
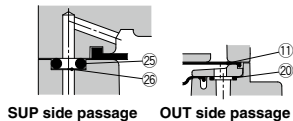

IR2120

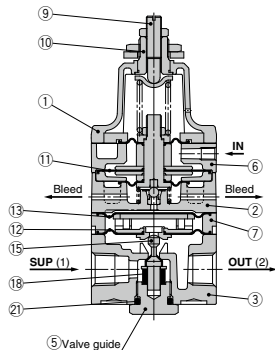
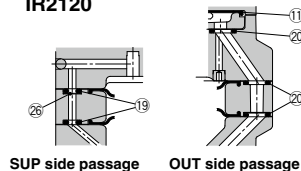

IR3120

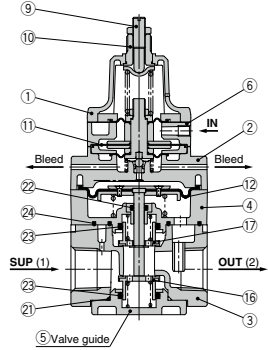
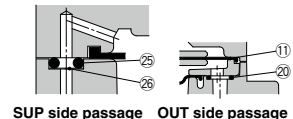

Working principle (For IR2000)

When the setting knob is turned, the nozzle is closed by the flapper allowing the supply air that flows in from the upstream side to pass through the fixed throttle. It then acts on diaphragm B as nozzle back pressure, the main valve is pushed down by the generated force, and the supply pressure flows out to the downstream side. The air pressure that flows in acts on diaphragm C. While opposing the force generated by diaphragm B it also acts on diaphragm A, opposing the compression force of the setting spring and becomes the set pressure. If the set pressure rises too high, diaphragm A is pushed up, the interval between the flapper and the nozzle widens, the nozzle back pressure drops, the balance of diaphragms B and C is broken, the main valve closes, the exhaust valve opens and the excess pressure from the downstream side is discharged to the atmosphere. In this way fine pressure variations are detected by the nozzle/flapper type pilot mechanism, and precise pressure adjustment is performed.

IR1000/2000/3000 Series

Construction (Refer to page 1101.)

Main Component Parts

No.	Description	Material				
		IR10□0	IR20□0	IR30□0	IR2120	IR3120
1	Bonnet	Aluminum alloy				
2	Nozzle valve element	Aluminum alloy				
3	Body	Aluminum alloy				
4	Intermediate body	—	—	Aluminum alloy	—	Aluminum alloy
5	Valve guide	Resin	Brass	Aluminum alloy	Brass	Aluminum alloy
6	Cover	—	—	—	Aluminum alloy	Aluminum alloy
7	Bleed ring	—	Resin	—	Resin	—
8	Setting knob	Resin/Steel			—	—
9	Adjusting screw	—	—	—	Steel	
10	Bush	Brass				

Replacement Parts

No.	Description	Material	IR10□0	IR20□0	IR30□0	IR2120	IR3120
11	Diaphragm assembly	NBR, other	1	1	1	1	1
12	Diaphragm assembly	NBR, other	1	1	1	1	1
13	Diaphragm	NBR, other		1		1	
14	Valve	Stainless steel, NBR	1				
15	Valve	Stainless steel, H-NBR		1		1	
16	Valve	Brass, NBR			1		1
17	Valve	Brass, NBR			1		1
18	Damper	NBR, other	1	1		1	
19	O-ring	H-NBR	3	2		2	
20	O-ring	NBR		3		3	1
21	O-ring	NBR	1	1	1	1	1
22	O-ring	NBR			1		1
23	O-ring	NBR			2		2
24	Seal (A)	NBR			1		1
25	Seal (B)	NBR			3		3
26	Fixed throttle	Stainless steel	1	1	1	1	1
Repair kit no. (A set of above nos. ① to ②⑥.)			KT-IR1000	KT-IR2000	KT-IR3000	KT-IR2120	KT-IR3120

Note 1) The replacement parts are shipped with the repair kit number.

Note 2) The sizes of the replacement parts included will vary according to the repair kit part number.

Dimensions

IR10□0-□01□

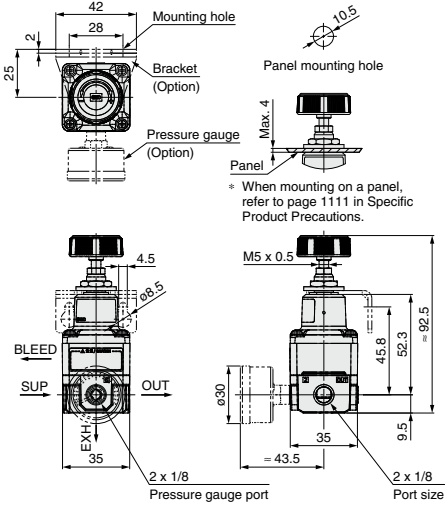

IR20□0-□02□

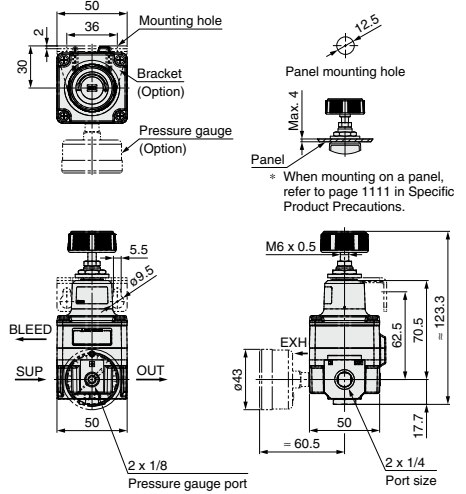

IR30□0-□0□□

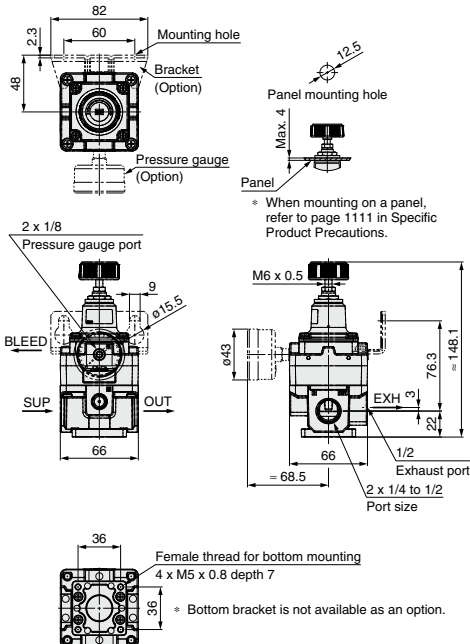

IR1000/2000/3000 Series

Dimensions

IR2120-□02□

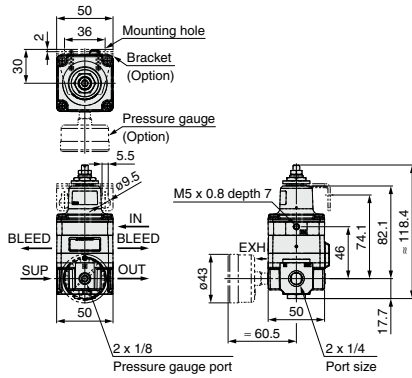

IR3120-□0□□

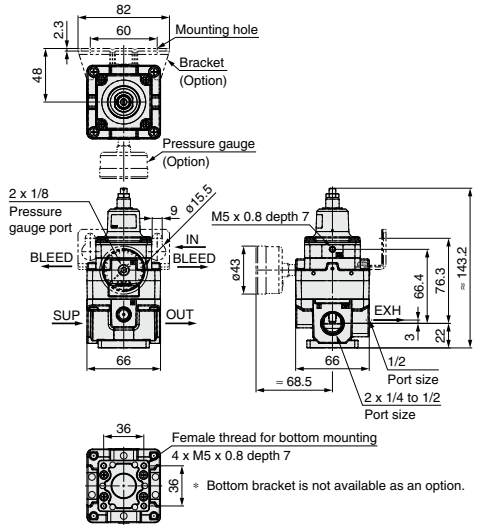

IR1000 Series

* The operating conditions or external disturbance may affect each of the characteristics. So, the characteristic values shown below are not guaranteed.

Flow Rate Characteristics

* Testing methods conform to JIS B 8372.

IR1000-01 Supply pressure: 0.5 MPa

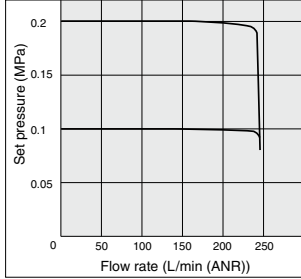

IR1010-01 Supply pressure: 0.7 MPa

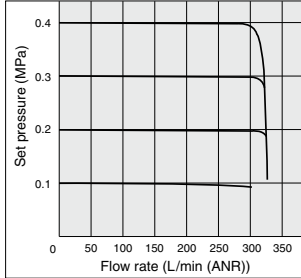

IR1020-01 Supply pressure: 1.0 MPa

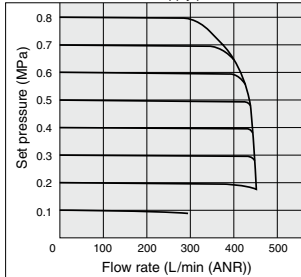

Relief Characteristics

IR1000-01 Back pressure: 0.5 MPa

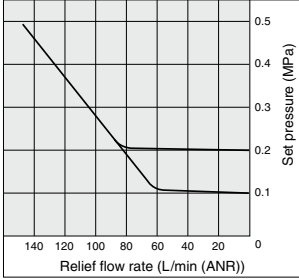

IR1010-01 Back pressure: 0.7 MPa

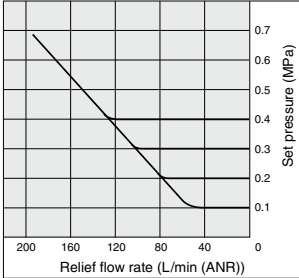

IR1020-01 Back pressure: 1.0 MPa

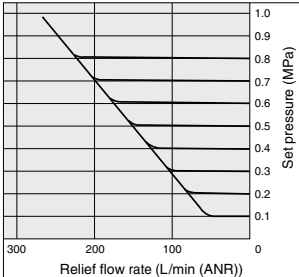

Pressure Characteristics

Supply pressure: 0.3 to 1.0 MPa
Set pressure: 0.2 MPa
Flow rate: 0 L/min (ANR)

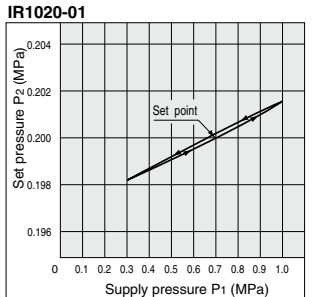
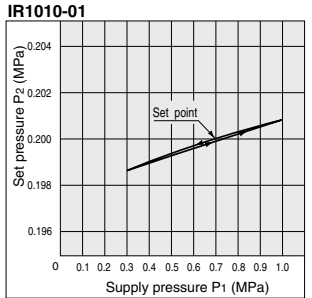
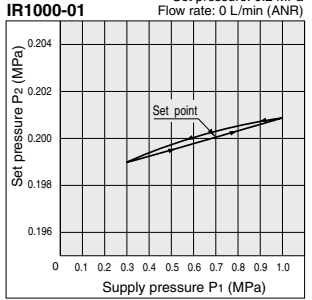

IR1000/2000/3000 Series

IR2000 Series

* The operating conditions or external disturbance may affect each of the characteristics. So, the characteristic values shown below are not guaranteed.

Flow Rate Characteristics

* Testing methods conform to JIS B 8372.

IR2000-02 Supply pressure: 0.5 MPa

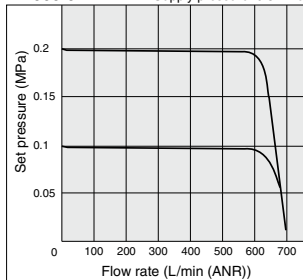

IR2010-02 Supply pressure: 0.7 MPa

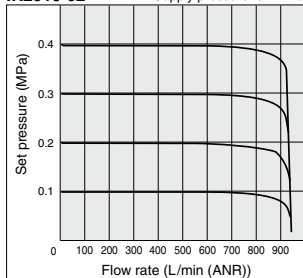

IR2020-02 Supply pressure: 1.0 MPa

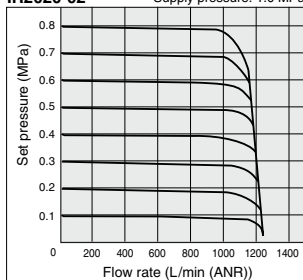

IR2120-02 Supply pressure: 1.0 MPa

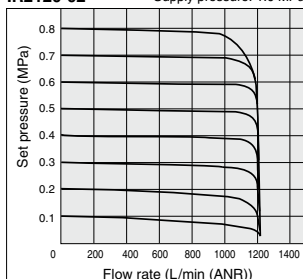

Relief Characteristics

IR2000-02 Back pressure: 0.5 MPa

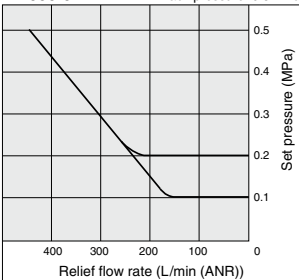

IR2010-02 Back pressure: 0.7 MPa

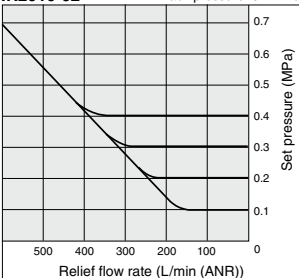

IR2020-02 Back pressure: 1.0 MPa

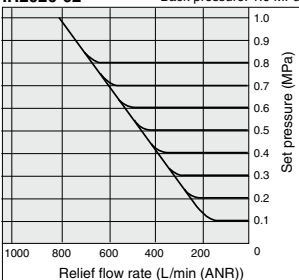

IR2120-02 Back pressure: 1.0 MPa

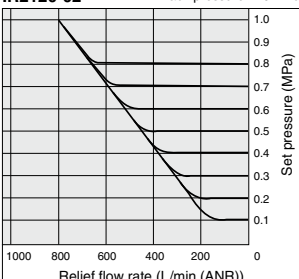

Pressure Characteristics

Supply pressure: 0.3 to 1.0 MPa
Set pressure: 0.2 MPa
Flow rate: 0 L/min (ANR)

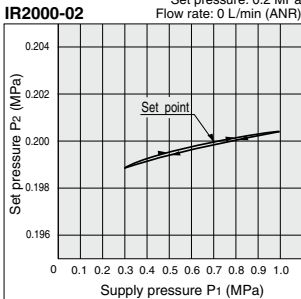

IR2010-02

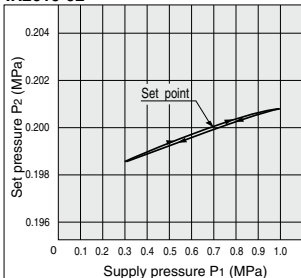

IR2020-02

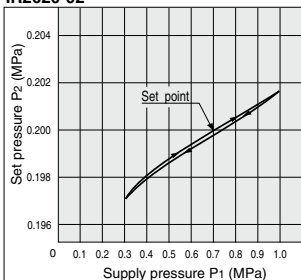

IR2120-02

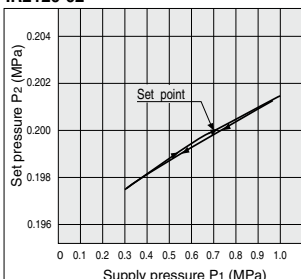

IR3000 Series

* The operating conditions or external disturbance may affect each of the characteristics. So, the characteristic values shown below are not guaranteed.

Flow Rate Characteristics

* Testing methods conform to JIS B 8372.

IR3000-03 Supply pressure: 0.5 MPa

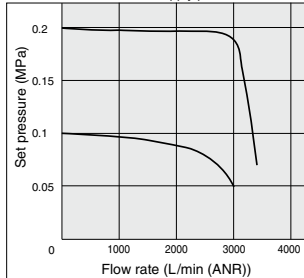

IR3010-03 Supply pressure: 0.7 MPa

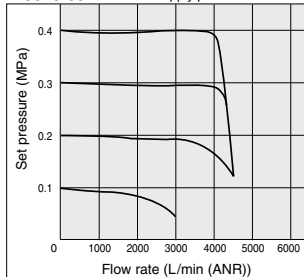

IR3020-03 Supply pressure: 1.0 MPa

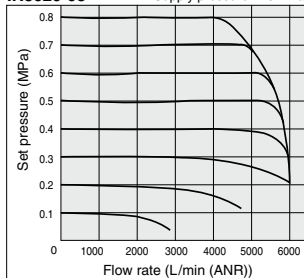

IR3120-03 Supply pressure: 1.0 MPa

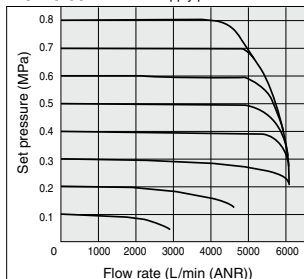

Relief Characteristics

IR3000-03 Back pressure: 0.5 MPa

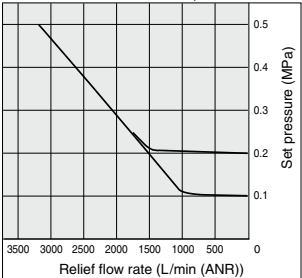

IR3010-03 Back pressure: 0.7 MPa

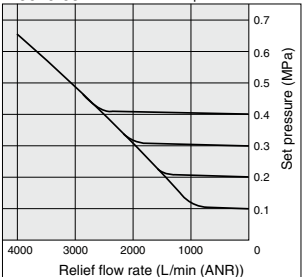

IR3020-03 Back pressure: 1.0 MPa

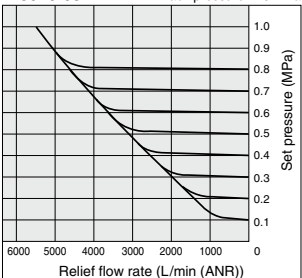

IR3120-03 Back pressure: 1.0 MPa

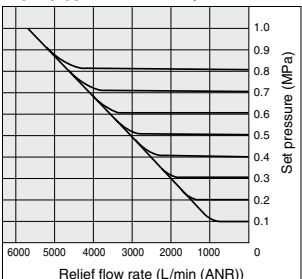

Pressure Characteristics

Supply pressure: 0.3 to 1.0 MPa
Set pressure: 0.2 MPa
Flow rate: 0 L/min (ANR)

IR3000-03

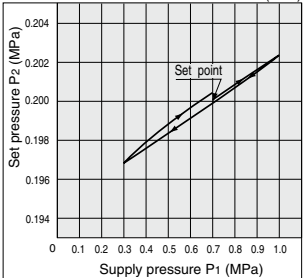

IR3010-03

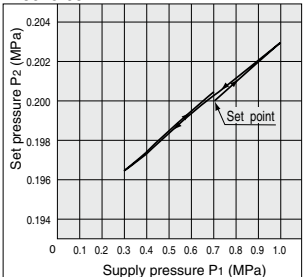

IR3020-03

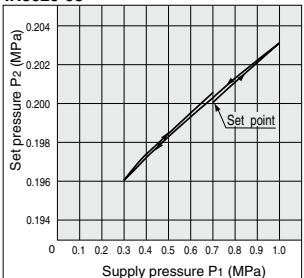

IR3120-03

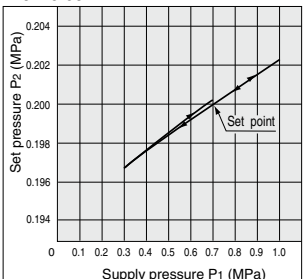

IR1000/2000/3000 Series

Made to Order

Please contact SMC for detailed dimensions, specifications, each part number and lead times.



How to Order

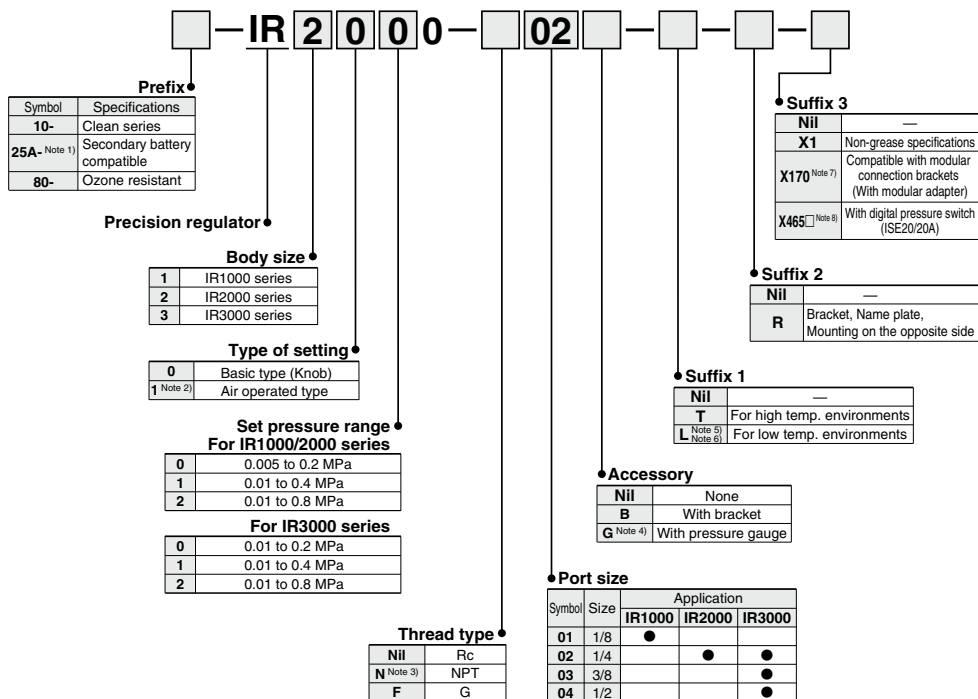

Note 1) The 25A- secondary battery compatible specification cannot be used in combination with accessory option "G" (with pressure gauge).

Note 2) Air operated type is IR2120 and IR3120 only.

Note 3) For thread type NPT, this product is for overseas use only according to the new Measurement Law. (The SI unit type is provided for use in Japan.)

Note 4) For the model with pressure gauge (G), the pressure gauge is shipped together, but not assembled.

Note 5) For the low temperature environment specification L, combinations with the pressure gauge (G) are not available.

Note 6) The low temperature environment specification L is not available for the IR1000 series.

Note 7) The X170 compatible with modular connection brackets specification cannot be used in combination with accessory option "B" (with bracket).

Note 8) The X465 with digital pressure switch specification cannot be used in combination with accessory option "G" (with pressure gauge).

Made to Order Combinations

○: Combination possible □: Combination not possible

	Prefix	Prefix			Suffix 1		Suffix 2		
		10-	25A-	80-	T	L	X1	X170	X465
Prefix	10-	○	○	○					○
	25A-	○	○	○					○
	80-	○	○	○			○	○	○
Suffix 1	T						○	○	
	L								
Suffix 2	X1			○	○				
	X170								
	X465	○	○	○					

1 Clean Series

10 - IR 0 -

• Clean series

Specifications

Cleanliness	ISO Class 3
Bleed hole	With M5 fitting (Applicable tubing O.D. ø6)
EXH port	IR1000/2000 series: With M5 fitting (Applicable tubing O.D. ø6) IR3000 series: Rc1/2 female thread
Breathing port	IR1000 series: With M3 fitting (Applicable tubing O.D. ø4) IR2000/3000 series: With M5 fitting (Applicable tubing O.D. ø6)
Pressure gauge	Oil-free + Stud parts nickle plated
Grease	Fluorine grease

Note 1) Assembly is performed in an ordinary assembly environment.
Note 2) Parts are not washed.

2 Secondary Battery Compatible

25A - IR 0 -

• Secondary battery compatible

Specifications

Parts material	Material mainly composed of copper or zinc is not used.
Parts surface treatment	Zinc chromate or copper-based plating is not used.
Grease	Grease compatible with low dew point

Note 1) Electroless nickel plating is used.
Note 2) Combinations with the pressure gauge are not available.

3 Ozone Resistant

Fluororubber is used for rubber seal materials.

80 - IR 0 -

• Ozone resistant

Modular Combination Example

Description	IR10□□-□01□-X170	IR2□□□-□02□-X170	IR3□□□-□□□-X170
① Regulator	IR10□□-□01□-X170	IR2□□□-□02□-X170	IR3□□□-□□□-X170
② Air filter	AF20-A	AF30-A	AF40-A
③ Mist separator	AFM20-A	AFM30-A	AFM40-A
④ Interface	Y200-A	Y300-A	Y400-A
⑤ Interface with bracket	Y200T-A	Y300T-A	Y400T-A

Note 1) The interface and interface with bracket listed above cannot be connected to the standard type.
Please order a modular adapter (E210/E310/E410 series) separately when connecting the standard type with modular connections.

Note 2) The modular adapter attached to the Made-to-Order product (IR□□□□-X170) is shipped together, but not assembled. Refer to page 917 for the recommended tightening torque necessary to connect the modular adapter.

Note 3) Air filter, mist separator, interface and interface with bracket are not included with the Made-to-Order product (-X170). Order them separately if required.

Note 4) Product numbers with the bracket are not available for IR□□□□-X170. As the interface with the bracket is used, it is not necessary to attach the bracket to the IR.

<Combination example>

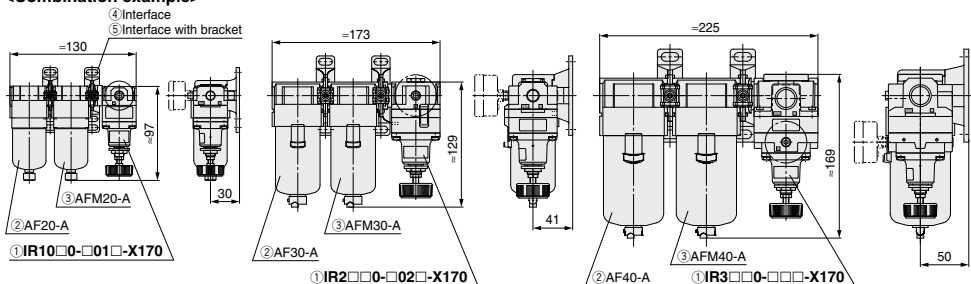

4 For High/Low Temperature Environments

IR 0 - - T

For high/low temperature environments

T	For high temperature
L	For low temperature

Specifications

Symbol	T	L
Environment	For high temp. environments	For low temp. environments
Ambient temperature	-5 to 100°C	-30 to 60°C
Rubber material	Fluororubber	Special NBR

Note 1) The low temperature environment specification L is not available for the IR1000 series.
Note 2) For the low temperature environment specification L, combinations with the pressure gauge (G) are not available.
Note 3) Max. 80°C for the high temperature environment specification T with pressure gauge (G)

5 Non-grease Specifications

IR 0 - - X1

Non-grease specifications

Note 1) Assembly is performed in an ordinary assembly environment.
Note 2) Parts are not washed.
Note 3) Fluorine grease is used on the following parts:
- IR1000/2000 series: Part of the non-wetted parts (threaded part on the setting knob)
- IR3000 series: Part of the wetted parts (sliding parts) and non-wetted parts (threaded part on the setting knob)

6 Compatible with Modular Connection Brackets

One modular adapter (E210/E310/E410 series) compatible with the port size of the regulator is provided. Connecting the modular adapter to the SUP port of the regulator enables the regulator to be connected to the modular connection bracket (Y200-A/Y300-A/Y400-A series).

IR 0 - - X170

Compatible with modular connection brackets

IR1000/2000/3000 Series

7 With Digital Pressure Switch

With digital pressure switch (model no: ISE20/20A-□-M-□01-L/J).
Mount a digital pressure switch into the connection port for pressure gauge, as it is not mounted at the time of shipment.

IR □ □ □ 0 - □ □ □ - X465 A

With digital pressure switch

Switch output specifications

Symbol	Output specifications	Part no.
A	NPN open collector 1 output	ISE20-N-M-□01-L
B	PNP open collector 1 output	ISE20-P-M-□01-L
C	NPN open collector 2 outputs + Analog voltage output	ISE20A-R-M-□01-J
D	NPN open collector 2 outputs + Analog current output	ISE20A-S-M-□01-J

Note 1) Please contact SMC separately for details about the external dimensions, etc.

Note 2) For details on handling digital pressure switch and specifications, refer to the **Web Catalog**.

Note 3) Digital pressure switch is packed together.

Note 4) The symbol G that indicates the inclusion of the pressure gauge is not necessary for the part number.

Note 5) Not applicable to both high and low temperature environments.

Note 6) The ambient temperature range is -5 to 50°C.

8 Manifold Specifications (Except IR2120 and IR3000 series)

2 to 8 station manifold type regulators.
(Please contact SMC regarding 9 or more stations.)

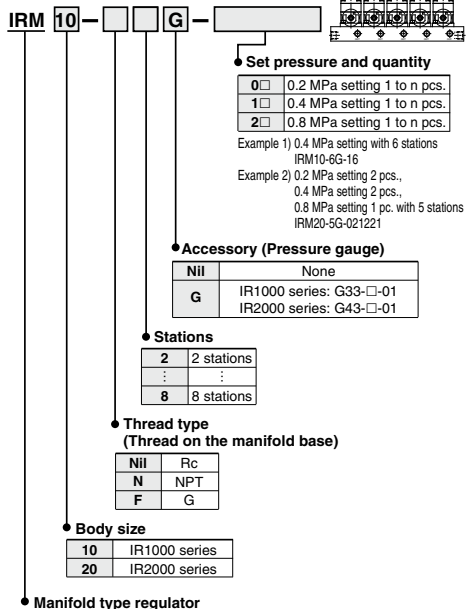

Specifications

Stations	2 to 8 stations	
Port	Common SUP	IR1000 series: 1/4, IR2000 series: 1/2
	Individual OUT	IR1000 series: 1/8, IR2000 series: 1/4
	Individual EXH (From IR body)	
Set pressure	0.2 MPa, 0.4 MPa and 0.8 MPa settings can be combined.	
Accessory (Pressure gauge)	G33-□-01 (IR1000 series), G43-□-01 (IR2000 series)	

Note 1) Regulators to be manifolded are counted starting from stations 1 on the left side with the OUT ports in front.

Note 2) When regulators with a different set pressure are manifolded, viewing OUT ports from front, the low pressure range is installed on the left side and high pressure range is on the right side. In case of the Example 2) above mentioned, stations 1 and 2 are of 0.2 MPa setting, stations 3 and 4 are of 0.4 MPa setting, and station 5 is of 0.8 MPa setting.

Note 3) When a blanking plate is needed, please contact SMC for the part number, etc.

Note 4) For thread type NPT, this product is for overseas use only according to the new Measurement Law. (The SI unit type is provided for use in Japan.)

Note 5) For the model with pressure gauge (G), the pressure gauge is shipped together, but not assembled.



IR1000/2000/3000 Series Specific Product Precautions 1

Be sure to read this before handling the products.

Refer to page 9 for safety instructions and pages 13 to 17 for precautions on every series.

Operating Environment

⚠ Warning

1. Do not use in an atmosphere having corrosive gases, chemicals, sea water, water, water steam, or where there is direct contact with any of these.
2. Do not operate in locations where vibration or impact occurs.
3. In locations which receive direct sunlight, provide a protective cover, etc.
4. In locations near heat sources, block off any radiated heat.
5. In locations where there is contact with spatter from water, oil or solder, etc., implement suitable protective measures.

Air Supply

⚠ Warning

1. Please consult with SMC when using the product in applications other than compressed air.
2. Do not use compressed air which includes chemicals, synthetic oils containing organic solvents, salt or corrosive gases, etc., as this can cause damage or malfunction.
3. If the drain removal from air filter and mist separator is missed, drain will be flown out to the outlet side and may result in a malfunction of the pneumatic equipment.

When removing drain is difficult, use of a filter with an auto-drain is recommended.

⚠ Caution

1. If the supply pressure line contains drain or dust, etc., the fixed throttle can become clogged leading to malfunction*, and therefore, in addition to an air filter (SMC AF series) be sure to install a mist separator (SMC AM, AFM series) and remove drain, etc. periodically.
For air quality, refer to Air Preparation Equipment Model Selection Guide on pages 20 and 21. For the maintenance method of the air preparation equipment, refer to the recommended method for the model in use.
2. Never use a lubricator on the supply side of the precision regulator, as this will positively cause the fixed throttle to become clogged and result in a malfunction*. If lubrication is required for terminal devices, connect a lubricator on the output side of the precision regulator.
* The following may occur if the fixed throttle is clogged or is getting clogged.
 - No output
 - Set pressure drops.
 - Set pressure is unstable.
 - Outlet pressure slowly rises.

Maintenance

⚠ Warning

1. When the valve guide (refer to construction drawing on page 1101) is to be removed during maintenance, first reduce the set pressure to "0" and completely shut off the supply pressure.
2. When a pressure gauge is to be mounted, remove the plug after reducing the set pressure to "0".

Precautions for IR10□0 only

⚠ Warning

1. When remounting the valve guide after removing it for maintenance, tighten the valve guide slowly using a tightening torque of no more than 0.6 N-m.
Since the valve guide on this product is made of resin, there is a danger of damage if tightened with a torque exceeding the prescribed value.

Handling

⚠ Caution

1. When the precision regulator with pressure gauge is used, do not apply impact to the product by dropping it, etc. during transportation or installation.
This may cause misalignment of the pressure gauge pointer.

Operation

⚠ Caution

1. Do not use a precision regulator outside the range of its specifications as this can cause failure. (Refer to specifications.)
2. When mounting is performed, make connections while confirming port indications.
3. Screw a panel nut with the recommended proper torque when mounting onto a panel.

Looseness or faulty sealing will occur if tightening torque is insufficient, while thread damage will result if the torque is excessive.

Recommended Proper Torque (N-m)

IR1000	IR2000	IR3000
12.5	21	21

4. If a directional switching valve (solenoid valve, mechanical valve, etc.) is mounted on the supply side of the precision regulator and repeatedly switched ON and OFF, wear of the nozzle/flapper section will be accelerated and a discrepancy in the setting value may occur. Therefore, avoid using a directional switching valve on the supply side. In the event a directional switching valve will be used, install it on the output side of the precision regulator.
5. The accessory pressure gauge is supplied with the precision regulator in the unassembled status. Before using the precision regulator, be sure to install the pressure gauge at the gauge port of the precision regulator. At this time, the recommended tightening torque of the pressure gauge is 7 to 9 N-m.



IR1000/2000/3000 Series Specific Product Precautions 2

Be sure to read this before handling the products.

Refer to page 9 for safety instructions and pages 13 to 17 for precautions on every series.

Operation

Caution

- Air is normally released from the bleed hole (the hole on the side of the body's mid-section). This is a necessary consumption of air based on the construction of the precision regulator, and is not an abnormality.
- Make sure to tighten the lock nut after pressure adjustment.
- There may be pulsation or noise depending on the pressure conditions, piping conditions and ambient environment. In this case, it is possible to improve the problem by changing the pressure conditions and piping conditions.

If the problem is not improved, please contact your SMC sales representative.

- After the pressure is supplied from the upstream side or the set pressure has been adjusted, the set pressure may gradually vary depending on the secular change of internal parts.

If the variation in the set pressure has become large, readjust the set pressure using the setting knob.

- The set pressure may vary if it is influenced by the variation in ambient temperature or fluid temperature. If the set pressure varies due to the influence of temperature, consider the management of ambient and fluid temperatures.

Precautions for IR30□0, IR3120 only

Caution

- The supply pressure is relatively high (approx. 0.5 MPa or more), the set pressure is low (approx. 0.1 MPa or less), and when operated with the output side released to the atmosphere, there may be pulsations in the setting pressure. In this kind of situation, operate with the supply pressure reduced as much as possible, or increase the set pressure somewhat and restrict the output line (add and adjust a stop valve, etc.).
- The capacity of the output side is large, and when used for the purpose of a relief function, the exhaust sound will be loud when being relieved. Therefore, operate with a silencer (SMC AN series) mounted on the exhaust port (EXH port). The connection is Rc 1/2.

Precautions for IR2120, IR3120

(air operated type) only

Caution

- Since the output types of IR2120 and IR3120 series are the same pressure as the input signal pressure, select a type of regulator (general purpose or precision type) for input signal pressure adjustment according to the application.
- The screw on the topmost section is a zero point adjustment screw that is locked at the factory. Adjusting the adjustment screw can cause the product to malfunction. Use the product without adjusting the adjustment screw.