

Wedge Cam Operation Slide Guide

MHK2 Series

Air Gripper/2-Finger Type $\phi 12$, $\phi 16$, $\phi 20$, $\phi 25$



MHZ
MHF
MHL
MHR
MHK
MHS
MHC
MHT
MHY
MHW
-X□
MRHQ
MA
D-□

Load Resistant, Dust Cover for Adverse Environments

2 types of finger materials

Standard: Carbon steel

Option: Stainless steel

3 types of dust cover materials

Standard: Chloroprene rubber (CR) Black

Optional: Fluororubber (FKM) Black

Silicone rubber White

Wedge Cam Operation Provides Dust Cover for Adverse

Top mounting centering location

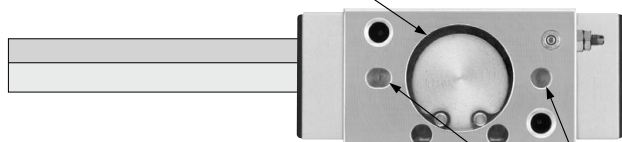

**Wedge Cam Operation Slide Guide
Air Gripper (2-Finger Type)**

**Pin hole for positioning
on top side**

Auto switch mountable

Grooves for auto switch are located on one side. Easy handling for adjustment and installation.

**Built-in adjustment needle
for finger speed**

Possible to adjust the speed for finger closing direction.

Wedge cam structure

The wedge structure allows no lateral vibration along stroke direction once work is held.

High rigidity

Slide type guide bearing enables highly rigid finger motion.

Improved performance

Incorporation of dust cover prevents dust, water, etc. from entering the body and avoids generating dust and releasing grease from air gripper.

**High precision
repeatability:
±0.01 mm**

**2 types of finger materials
are available for different
applications.**

Standard: Carbon steel
Option: Stainless steel

**3 types of dust covers are
available for use in different
environments.**

Standard: Chloroprene rubber (CR) Black
Optional: Fluororubber (FKM) Black
Silicone rubber White

Longer strokes are now standard.

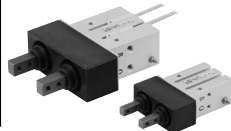

Bore size (mm)	Opening/Closing stroke (mm)	
	Long stroke	Standard stroke
12	11	4
16	14	6
20	18	10
25	22	14

High Precision and Rigidity. Environmental Conditions.



MHK2 Series

Application

Assembling

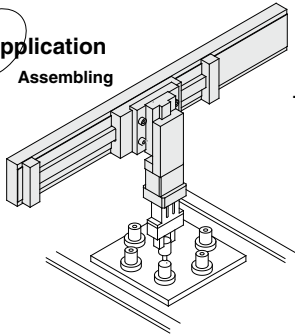

Transferring

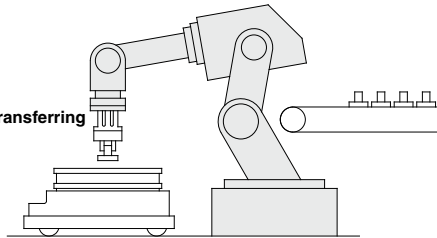

Loading/Unloading work into machine tools

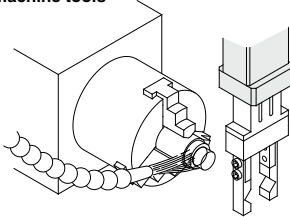

Universal mounting

Axial mounting

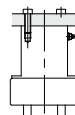

(Body tapped)

Vertical mounting

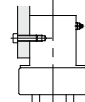

(Body tapped)

Lateral mounting

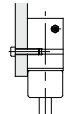

(Body tapped)

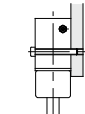

(Body through-hole)

Interchangeable with MHQG2 Series

Series Variations

Series	Model	Bore size (mm)	Opening/Closing stroke (mm)	Option	
Parallel opening/closing	Standard type MHK2 Series	MHK2-12□	12	4	<ul style="list-style-type: none"> ■ Finger option Carbon steel (Standard), Stainless steel ■ Dust cover option Chloroprene rubber (Standard) Fluororubber Silicone rubber ■ Auto switch Solid state switch D-M9N(V), D-M9P(V) D-M9B(V), Water resistant (2-color indicator), D-M9□A(V)
		MHK2-16□	16	6	
		MHK2-20□	20	10	
		MHK2-25□	25	14	
	Long stroke type MHKL2 Series	MHKL2-12□	12	11	
		MHKL2-16□	16	14	
		MHKL2-20□	20	18	
		MHKL2-25□	25	22	

MHZ

MHF

MHL

MHR

MHK

MHS

MHC

MHT

MHY

MHW

-X□

MRHQ

MA

D-□

Wedge Cam Operation Slide Guide

Air Gripper/2-Finger Type

MHK2 Series

ø12, ø16, ø20, ø25

How to Order

Standard type

MHK 2 - 20 D 1 F - M9B

Long stroke type

MHKL 2 - 20 D 1 F - M9B

Number of fingers
2 2 fingers

Bore size

12	12 mm
16	16 mm
20	20 mm
25	25 mm

Action

D	Double acting
S	Single acting (Normally open)
C	Single acting (Normally closed)

Finger material

Nil	Carbon steel
1	Stainless steel

Made to Order
Refer to page 551 for details.

Number of auto switches

Nil	2 pcs.
S	1 pc.

Auto switch

Nil	Without auto switch (Built-in magnet)
-----	---------------------------------------

Dust cover material

Nil	Chloroprene rubber (CR)
F	Fluororubber (FKM)
S	Silicone rubber

Applicable Auto Switches

Refer to pages 797 to 850 for further information on auto switches.

Type	Special function	Electrical entry	Indicator light	Wiring (Output)	Load voltage		Auto Switch model		Lead wire length (m) ^{*)}			Pre-wired connector	Applicable load	
					DC	AC	Electrical entry direction		0.5 (Nil)	1 (M)	3 (L)			5 (Z)
							Perpendicular	In-line						
Solid state auto switch	—	Grommet	Yes	3-wire (NPN)	5 V,	—	M9NV	M9N	●	●	○	○	Relay, PLC	
				3-wire (PNP)	12 V		M9PV	M9P	●	●	○	○		
	2-wire			12 V	M9BV		M9B	●	●	○	○			
	3-wire (NPN)			5 V,	M9NVW		M9NW	●	●	○	○			
	3-wire (PNP)			12 V	M9PVW		M9PW	●	●	○	○			
	2-wire			12 V	M9BWW		M9BW	●	●	○	○			
	3-wire (NPN)			5 V,	M9NAV**		M9NA**	○	○	○	○			
	3-wire (PNP)			12 V	M9PAV**		M9PA**	○	○	○	○			
	2-wire			12 V	M9BAV**		M9BA**	○	○	○	○			

** Water resistant type auto switches can be mounted on the above models, but in such case SMC cannot guarantee water resistance.

*) Lead wire length symbols: 0.5 m Nil (Example) M9NW
 1 m M (Example) M9NWM
 3 m L (Example) M9NWL
 5 m Z (Example) M9NWZ

*) Auto switches marked with a "○" symbol are produced upon receipt of order.

(Note) When using the 2-color indicator type, please make the setting so that the indicator is lit in red to ensure the detection at the proper position of the air gripper.

Specifications

Fluid	Air	
Operating pressure	Double acting	0.1 to 0.6 MPa
	Single acting Normally open Normally closed	0.25 to 0.6 MPa
Ambient and fluid temperature	-10 to 60°C	
Repeatability	±0.01 mm	
Lubrication	Not required	
Action	Double acting/Single acting	
Auto switch (Option) <small>Note)</small>	Solid state auto switch (3-wire, 2-wire)	

Note) Refer to pages 797 to 850 for further information on auto switches.



Symbol

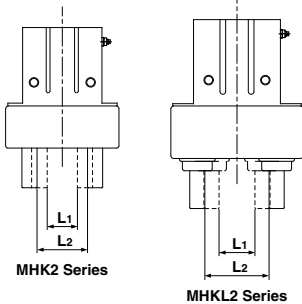
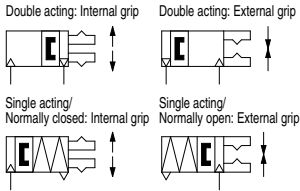

MHK2 Series

MHKL2 Series



Made to Order: Individual Specifications
(For details, refer to pages 565 and 566.)

Symbol	Specifications/Description
-X39	With grease nipple
-X41	Auto switch groove (Both-side type)



Made to Order
[Click here for details](#)

Symbol	Specifications/Description
-X4	Heat resistance (100°C)
-X5	Fluororubber seal
-X7	Closing direction spring assist
-X12	Opening direction spring assist
-X50	Without magnet
-X53	EPDM seal/Fluorine grease
-X63	Fluorine grease
-X64	Finger: Side tapped mounting
-X65	Finger: Through-hole mounting
-X77A	Dust cover adhesion
-X77B	Dust cover adhesion (Finger part only)
-X78A	Dust cover caulking
-X78B	Dust cover caulking (Finger part only)
-X79	Grease for food processing machines, Fluorine grease
-X79A	Grease for food processing machines

Option

Finger material	Carbon steel (Standard), Stainless steel
Dust cover material	Chloroprene rubber (CR) (Standard), Fluororubber (FKM), Silicone rubber

Model

MHK2 Series/Standard Type

Action	Model	Bore size (mm)	Max. operating frequency (c.p.m)	Effective gripping force per finger (N) <small>Note)</small>	Opening/Closing stroke (mm) L2-L1	Width at closing (mm) L1	Width at opening (mm) L2	Weight (g)	
Double acting	MHK2-12D□	12	120	External grip: 15 Internal grip: 16	4	9	13	75	
	MHK2-16D□	16		External grip: 31 Internal grip: 36	6	14.6	20.6	113	
	MHK2-20D□	20		External grip: 46 Internal grip: 56	10	16	26	235	
	MHK2-25D□	25		External grip: 80 Internal grip: 86	14	19	33	440	
Single acting	Normally open	MHK2-12S□		12	9	4	9	13	76
		MHK2-16S□		16	23	6	14.6	20.6	114
		MHK2-20S□		20	34	10	16	26	237
		MHK2-25S□		25	58	14	19	33	443
	Normally closed	MHK2-12C□		12	12	4	9	13	76
		MHK2-16C□		16	25	6	14.6	20.6	115
		MHK2-20C□		20	44	10	16	26	237
		MHK2-25C□		25	73	14	19	33	443

MHKL2 Series/Long Stroke Type

Action	Model	Bore size (mm)	Max. operating frequency (c.p.m)	Effective gripping force per finger (N) <small>Note)</small>	Opening/Closing stroke (mm) L2-L1	Width at closing (mm) L1	Width at opening (mm) L2	Weight (g)	
Double acting	MHKL2-12D□	12	90	External grip: 14 Internal grip: 16	11	9	20	104	
	MHKL2-16D□	16		External grip: 27 Internal grip: 30	14	14.6	28.6	164	
	MHKL2-20D□	20		External grip: 45 Internal grip: 53	18	16	34	312	
	MHKL2-25D□	25		External grip: 79 Internal grip: 90	22	19	41	562	
Single acting	Normally open	MHKL2-12S□		12	9	11	9	20	105
		MHKL2-16S□		16	17	14	14.6	28.6	165
		MHKL2-20S□		20	32	18	16	34	314
		MHKL2-25S□		25	53	22	19	41	565
	Normally closed	MHKL2-12C□		12	11	11	9	20	105
		MHKL2-16C□		16	22	14	14.6	28.6	166
		MHKL2-20C□		20	40	18	16	34	314
		MHKL2-25C□		25	63	22	19	41	565

Note) At the pressure of 0.5 MPa, when gripping point L is 20 mm.
Single acting normally open: External holding force, Single acting normally closed: Internal gripping force.
Refer to "Effective Gripping Force" for the gripping force at each gripping position on pages 553 to 557.

- MHZ
- MHF
- MHL
- MHR
- MHK
- MHS
- MHC
- MHT
- MHY
- MHW
- X□
- MRHQ
- MA
- D-□

MHK2 Series

Construction

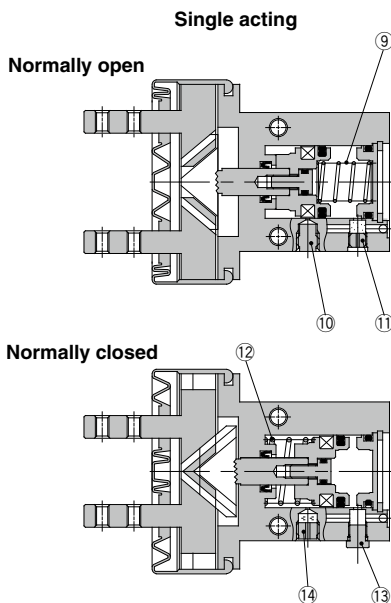
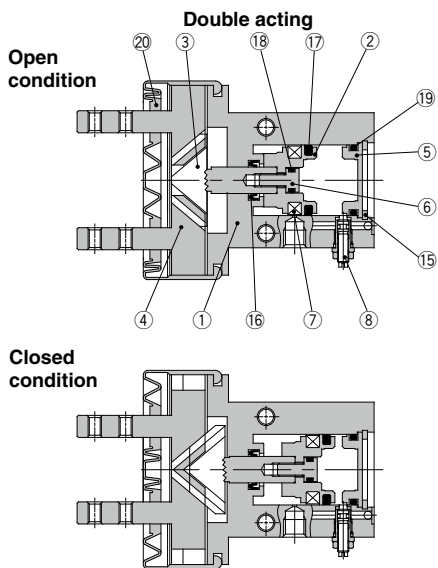

Component Parts

No.	Description	Material	Note
1	Body	Aluminum alloy	Hard anodized
2	Piston	Aluminum alloy	Hard anodized
3	Cam	Carbon steel	Heat treated, Specially treated
4	Finger	Carbon steel	Heat treated, Specially treated
		Stainless steel 304	Option
5	Cap	Aluminum alloy	Hard anodized
6	Piston bolt	Stainless steel	
7	Rubber magnet	Synthetic rubber	

No.	Description	Material	Note
8	Needle assembly		
9	N.O. spring	Piano wire	
10	Plug	Brass	Electroless nickel plated
11	Exhaust plug	Brass	Electroless nickel plated
12	N.C. spring	Piano wire	
13	Plug assembly	Brass	Electroless nickel plated
14	Exhaust plug A	Brass	Electroless nickel plated
15	Type C retaining ring	Carbon steel	Nickel plated

MHK2 Replacement Parts

Description	MHK2-12□	MHK2-16□	MHK2-20□	MHK2-25□	Main parts	
Seal kit	MHK12-PS	MHK16-PS	MHK20-PS	MHK25-PS	①⑥①⑦⑱⑲	
Piston assembly	MHK-A1201	MHK-A1601	MHK-A2001	MHK-A2501	②⑥⑦	
Cam	P3318103	P3318203	P3318303	P3318403	③	
Finger	Material: Carbon steel	P3318104	P3318204	P3318304	④	
	Stainless steel	P3318104-1	P3318204-1	P3318304-1		
Needle assembly	MHK-A1206				⑧	
Dust cover	Material: CR	MHK2-J12	MHK2-J16	MHK2-J20	MHK2-J25	⑳
	FKM	MHK2-J12F	MHK2-J16F	MHK2-J20F	MHK2-J25F	
	Silicone rubber	MHK2-J12S	MHK2-J16S	MHK2-J20S	MHK2-J25S	

* Order 2 pieces per one finger unit.

Replacement part/Grease pack part no.: MH-G01 (30 g)

MHKL2 Replacement Parts

Description	MHKL2-12□	MHKL2-16□	MHKL2-20□	MHKL2-25□	Main parts	
Seal kit	MHK12-PS	MHK16-PS	MHK20-PS	MHK25-PS	①⑥①⑦⑱⑲	
Piston assembly	MHK-A1201	MHK-A1601	MHK-A2001	MHK-A2501	②⑥⑦	
Cam	P3318111	P3318211	P3318311	P3318411	③	
Finger	Material: Carbon steel	P3318112	P3318212	P3318312	④	
	Stainless steel	P3318112-1	P3318212-1	P3318312-1		
Needle assembly	MHK-A1206				⑧	
Dust cover	Material: CR	MHKL2-J12	MHKL2-J16	MHKL2-J20	MHKL2-J25	⑳
	FKM	MHKL2-J12F	MHKL2-J16F	MHKL2-J20F	MHKL2-J25F	
	Silicone rubber	MHKL2-J12S	MHKL2-J16S	MHKL2-J20S	MHKL2-J25S	

* Order 2 pieces per one finger unit.

Replacement part/Grease pack part no.: MH-G01 (30 g)

Model Selection Example

Procedure

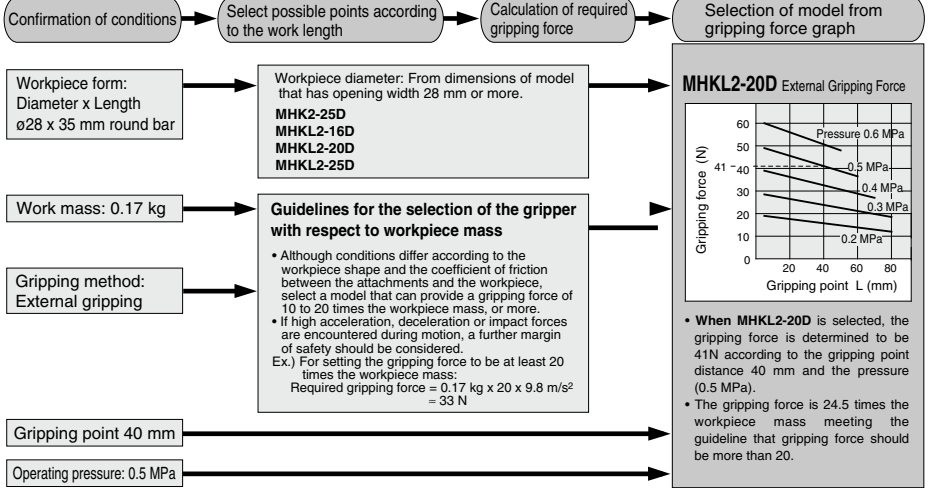

Gripping Point

External grip

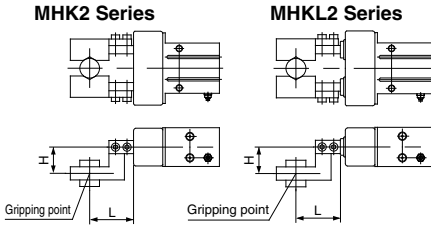

Internal grip

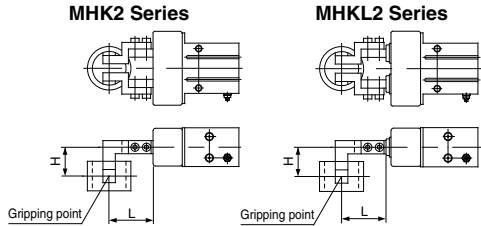

L: Gripping point distance
H: Overhang distance

- Proper gripping points should be selected in accordance with the operating pressure. The distance to the gripping point L and the overhang distance H should be within the limited range given in the graphs below.
- When the gripping point distance becomes large, the finger attachment applies an excessively large load to the finger sliding section, causing excessive play of the fingers and possibly leading to premature failure.

Gripping Point Range Limit

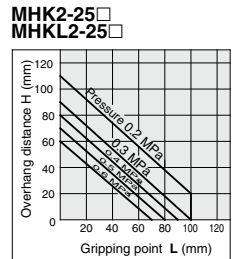
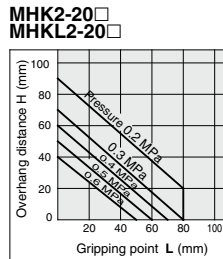
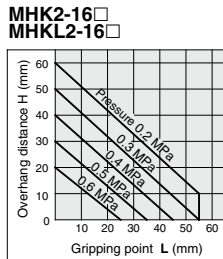
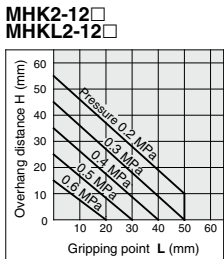

Note) Distance to the gripping point L of single acting type is shortened by spring return.
Use air gripper within gripping force line shown for each pressure in effective gripping force graph.

- MHZ
- MHF
- MHL
- MHR
- MHK**
- MHS
- MHC
- MHT
- MHY
- MHW
- X □
- MRHQ
- MA
- D- □

MHK2 Series

Effective Gripping Force: MHK2 Series Double Acting

• Indication of effective gripping force

The effective gripping force shown in the graphs to the right is expressed as F , which is the thrust of one finger, when both fingers and attachments are in full contact with the workpiece as shown in the figure below.

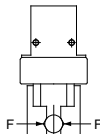

External grip
MHK2 Series

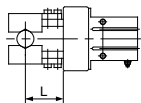

Internal grip
MHK2 Series

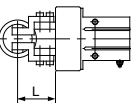

External Grip

MHK2-12D

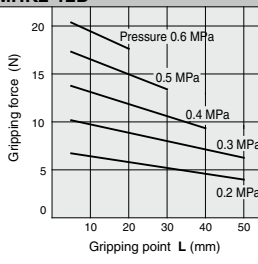

Internal Grip

MHK2-12D

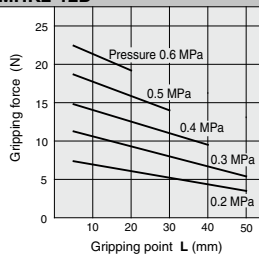

MHK2-16D

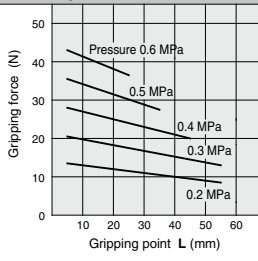

MHK2-16D

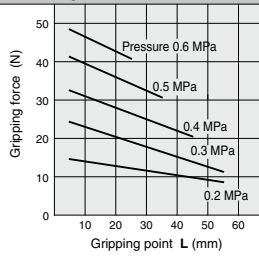

MHK2-20D

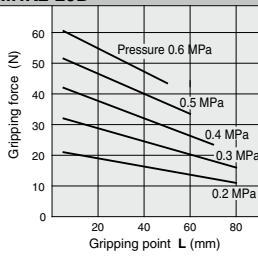

MHK2-20D

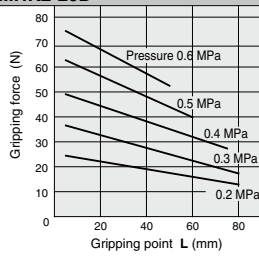

MHK2-25D

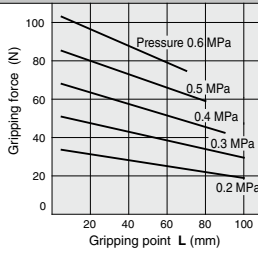

MHK2-25D

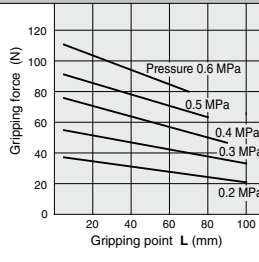

Effective Gripping Force: MHKL2 Series Double Acting

• Indication of effective gripping force

The effective gripping force shown in the graphs to the right is expressed as F , which is the thrust of one finger, when both fingers and attachments are in full contact with the workpiece as shown in the figure below.

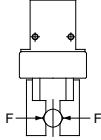

External grip
MHKL2 Series

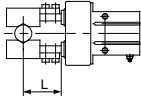

Internal grip
MHKL2 Series

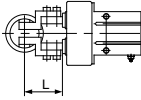

External Grip

MHKL2-12D

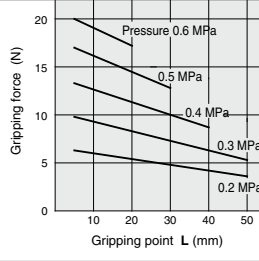

MHKL2-16D

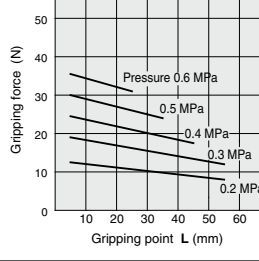

MHKL2-20D

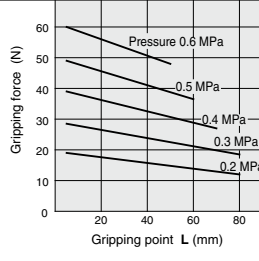

MHKL2-25D

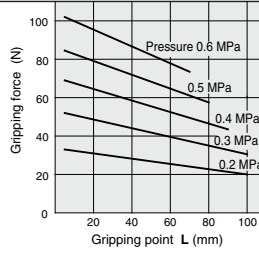

Internal Grip

MHKL2-12D

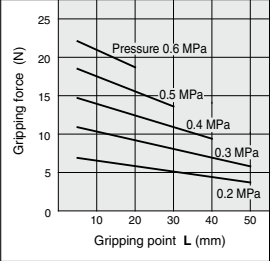

MHKL2-16D

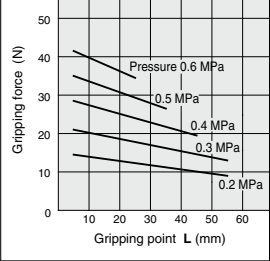

MHKL2-20D

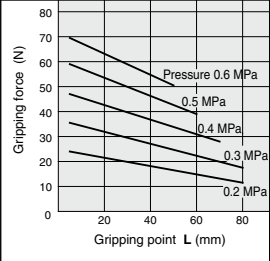

MHKL2-25D

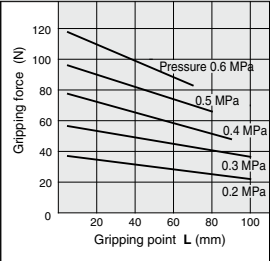

MHZ

MHF

MHL

MHR

MHK

MHS

MHC

MHT

MHY

MHW

-X

MRHQ

MA

D-

MHK2 Series

Effective Gripping Force: MHK2 Series Single Acting

Indication of effective gripping force

The effective gripping force shown in the graphs to the right is expressed as F , which is the thrust of one finger, when both fingers and attachments are in full contact with the workpiece as shown in the figure below.

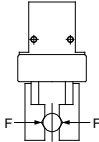

Note) In case of single acting type, the value is for stroke center.

External grip MHK2 Series

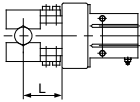

Internal grip MHK2 Series

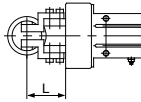

Precautions when using the single acting type:

If a moment such as that illustrated below is applied to the finger, the finger might not be able to retract by the spring force alone. Therefore, make sure to use the air gripper within the allowable moment that is indicated in the table below.

Allowable Moment

Model	Allowable moment (N·m)
MHK2-12S/C	0.05
MHK2-16S/C	0.12
MHK2-20S/C	0.25
MHK2-25S/C	0.49

M: Allowable moment
($M = WL$)

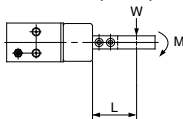

External Grip

MHK2-12S

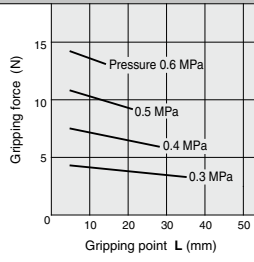

Internal Grip

MHK2-12C

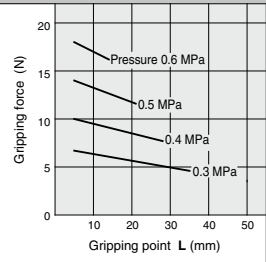

MHK2-16S

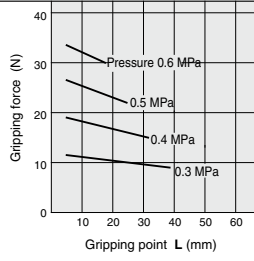

MHK2-16C

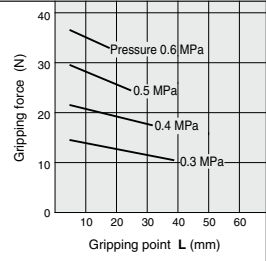

MHK2-20S

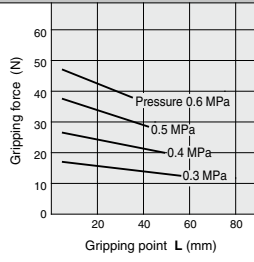

MHK2-20C

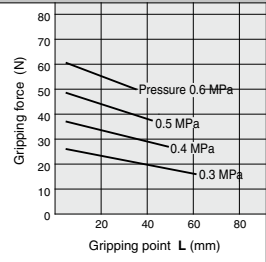

MHK2-25S

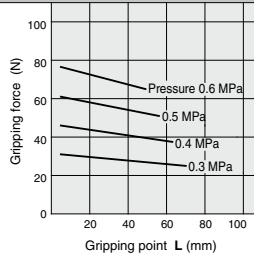

MHK2-25C

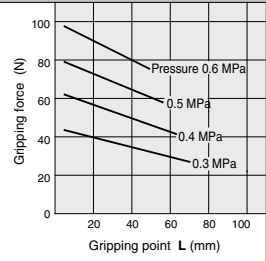

Effective Gripping Force: MHKL2 Series Single Acting

• Indication of effective gripping force

The effective gripping force shown in the graphs to the right is expressed as F, which is the thrust of one finger, when both fingers and attachments are in full contact with the workpiece as shown in the figure below.

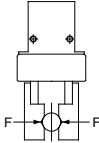

Note) In case of single acting type, the value is for stroke center.

External grip MHKL2 Series

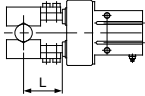

Internal grip MHKL2 Series

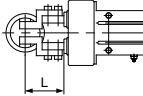

• Precautions when using the single acting type:

If a moment such as that illustrated below is applied to the finger, the finger might not be able to retract by the spring force alone. Therefore, make sure to use the air gripper within the allowable moment that is indicated in the table below.

Allowable Moment

Model	Allowable moment (N·m)
MHKL2-12S/C	0.05
MHKL2-16S/C	0.12
MHKL2-20S/C	0.25
MHKL2-25S/C	0.49

M: Allowable moment
($M = WL$)

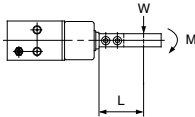

External Grip

MHKL2-12S

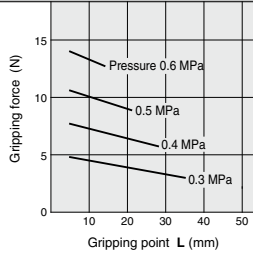

MHKL2-16S

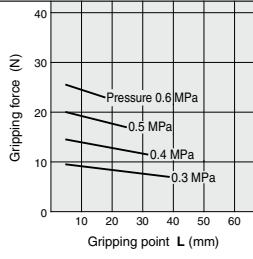

MHKL2-20S

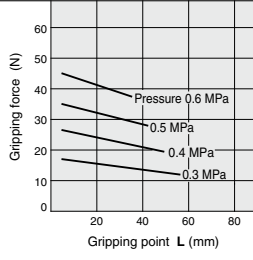

MHKL2-25S

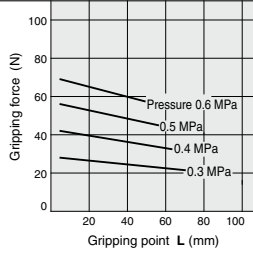

Internal Grip

MHKL2-12C

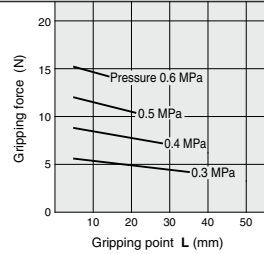

MHKL2-16C

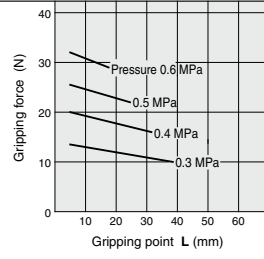

MHKL2-20C

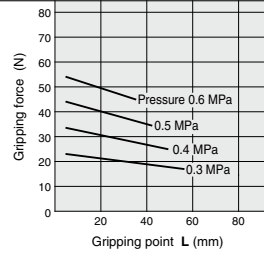

MHKL2-25C

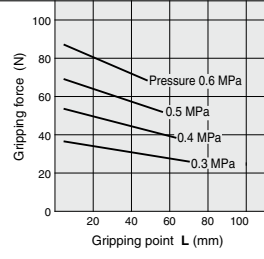

MHZ

MHF

MHL

MHR

MHK

MHS

MHC

MHT

MHY

MHW

-X

MRHQ

MA

D-

MHK2 Series

Dimensions

MHK2-12□: Standard type

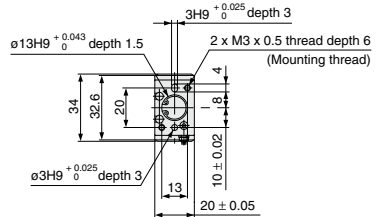
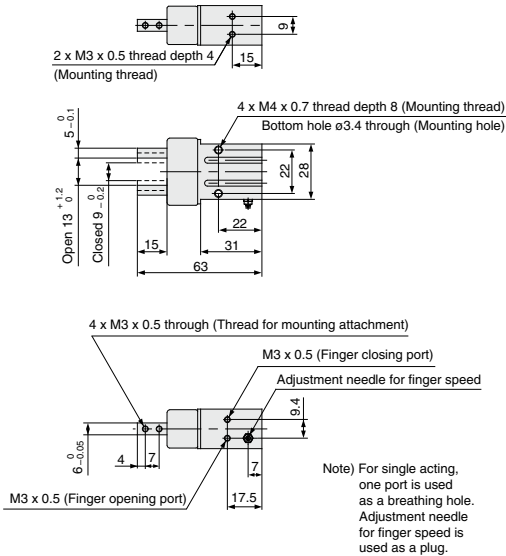

Auto Switch Mounting Groove Dimensions

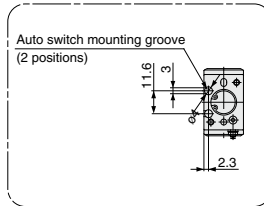

MHKL2-12□: Long stroke type

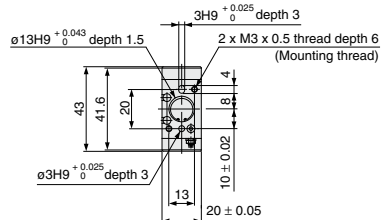
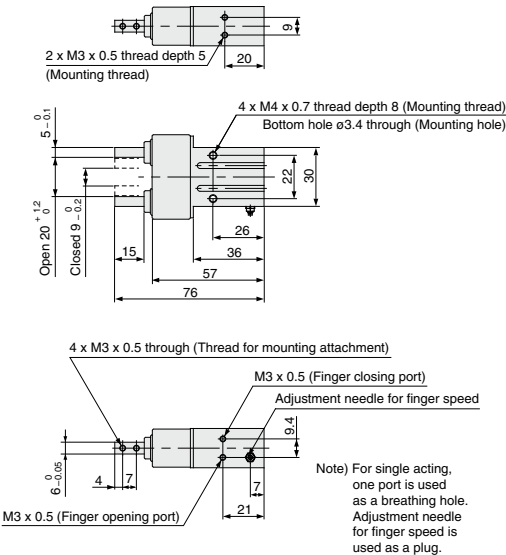

Auto Switch Mounting Groove Dimensions

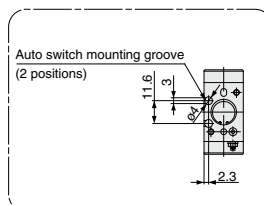

MHK2-16□: Standard type

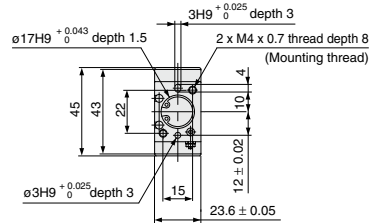
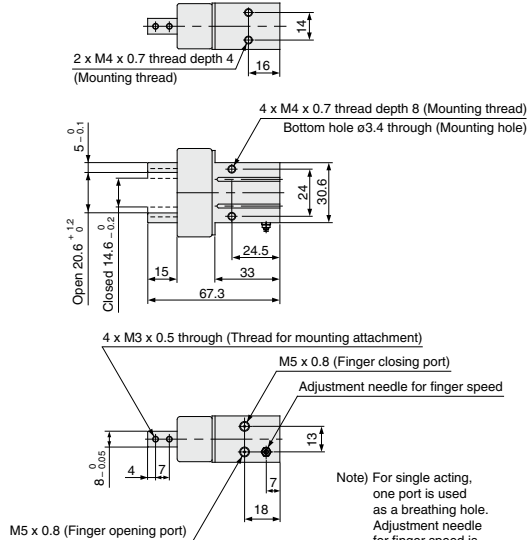

Auto Switch Mounting Groove Dimensions

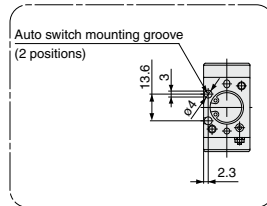

MHKL2-16□: Long stroke type

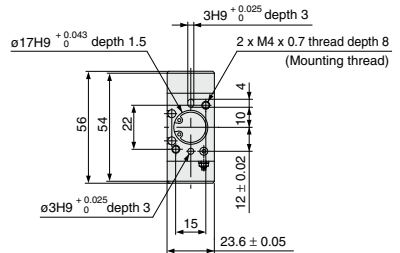
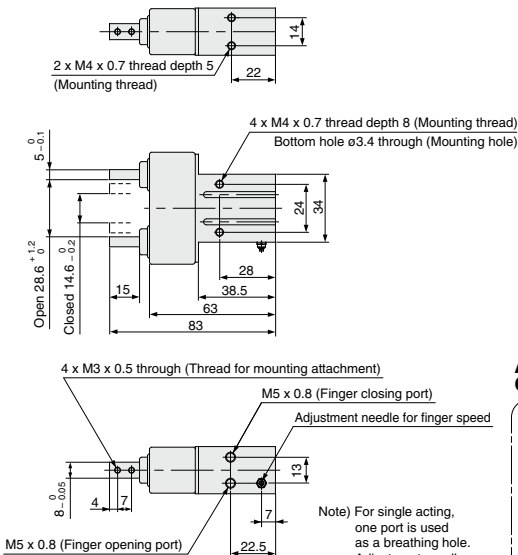

Auto Switch Mounting Groove Dimensions

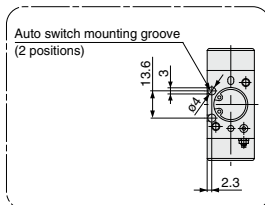

- MHZ
- MHF
- MHL
- MHR
- MHK**
- MHS
- MHC
- MHT
- MHY
- MHW
- X□
- MRHQ
- MA
- D-□

MHK2 Series

Dimensions

MHK2-20□: Standard type

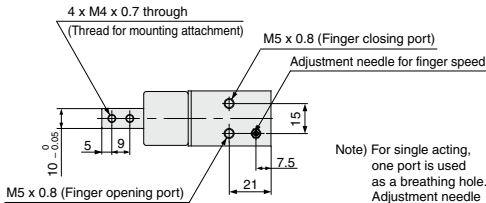
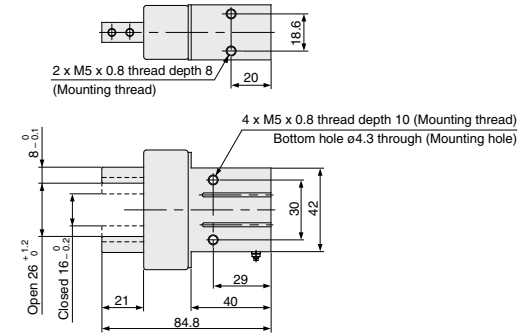

Note) For single acting, one port is used as a breathing hole. Adjustment needle for finger speed is used as a plug.

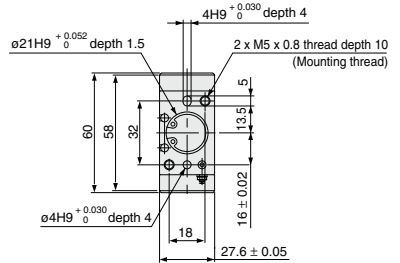

Auto Switch Mounting Groove Dimensions

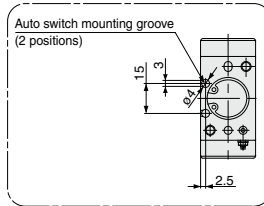

MHKL2-20□: Long stroke type

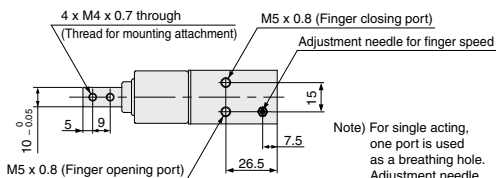
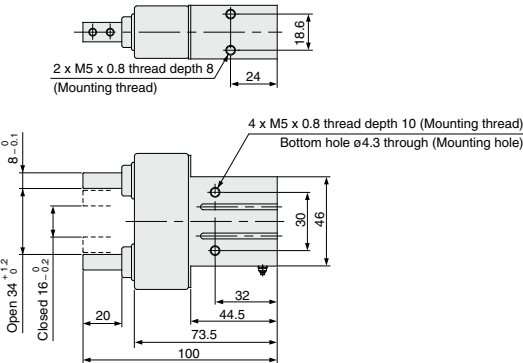

Note) For single acting, one port is used as a breathing hole. Adjustment needle for finger speed is used as a plug.

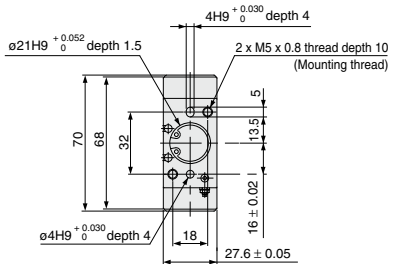

Auto Switch Mounting Groove Dimensions

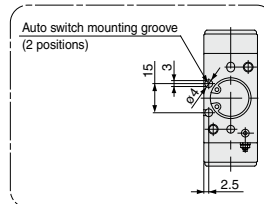

MHK2-25□: Standard type

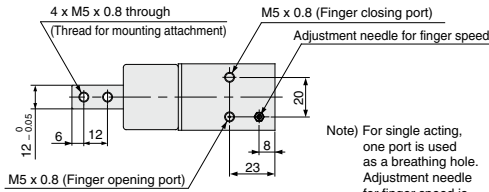
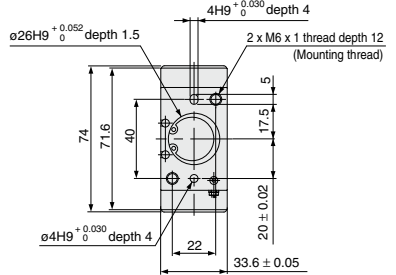
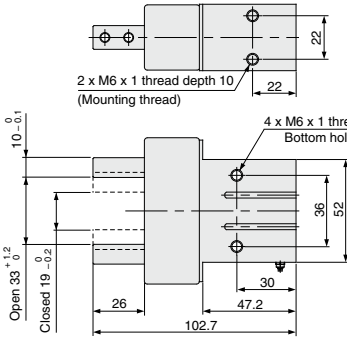

Note) For single acting, one port is used as a breathing hole. Adjustment needle for finger speed is used as a plug.

Auto Switch Mounting Groove Dimensions

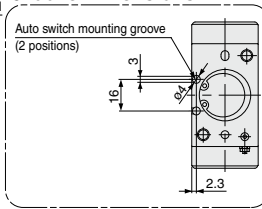

MHKL2-25□: Long stroke type

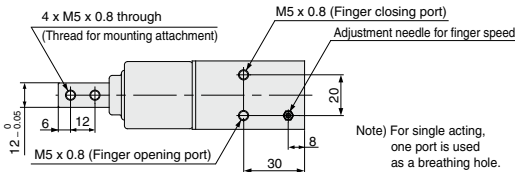
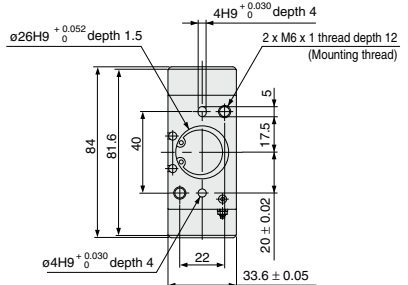
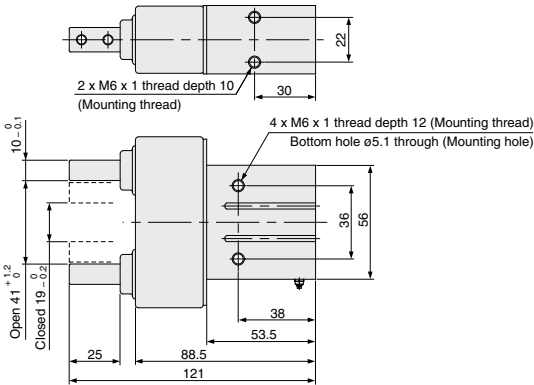

Note) For single acting, one port is used as a breathing hole. Adjustment needle for finger speed is used as a plug.

Auto Switch Mounting Groove Dimensions

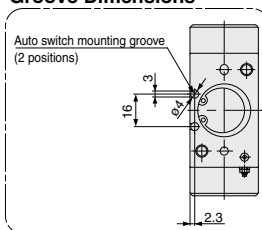

- MHZ
- MHF
- MHL
- MHR
- MHK**
- MHS
- MHC
- MHT
- MHY
- MHW
- X□
- MRHQ
- MA
- D-□

MHK2/MHKL2 Series

Auto Switch Installation Examples and Mounting Positions

Various auto switch applications are possible through different combinations of auto switch quantities and detecting positions.

1) Detection when Gripping Exterior of Workpiece



Detection example		1. Confirmation of fingers in reset position	2. Confirmation of workpiece held	3. Confirmation of workpiece released
Position to be detected		Position of fingers fully opened	Position when gripping a workpiece	Position of fingers fully closed
Operation of auto switch		Auto switch turned ON when fingers return. (Light ON)	Auto switch turned ON when gripping a workpiece. (Light ON)	When a workpiece is not held (Abnormal operation): Auto switch to turn ON (Light ON)
Detection combinations	One auto switch = One position, any of ①, ② and ③ can be detected.	●	●	●
	Two auto switches = Two positions of ①, ② and ③ can be detected.	Pattern A	●	—
		Pattern B	—	●
Pattern C	●	—	●	
How to determine auto switch installation position		Step 1) Fully open the fingers.	Step 1) Position fingers for gripping a workpiece.	Step 1) Fully close the fingers.
At no pressure or low pressure, connect the auto switch to a power supply, and follow the directions.		Step 2) Insert the auto switch into the auto switch installation groove in the direction shown in the following drawing.		
		Step 3) Slide the auto switch in the direction of the arrow until the indicator light illuminates.	Step 3) Slide the auto switch in the direction of the arrow until the light illuminates and fasten it at a position 0.3 to 0.5 mm in the direction of the arrow beyond the position where the indicator light illuminates.	
		Step 4) Slide the auto switch further in the direction of the arrow until the indicator light goes out.	Position where light turns ON	
		Step 5) Move the auto switch in the opposite direction and fasten it at a position 0.3 to 0.5 mm beyond the position where the indicator light illuminates.	Position to be secured	
		Position where light turns ON	Position to be secured	

Note 1) It is recommended that gripping of a workpiece be performed close to the center of the finger stroke.

Note 2) When holding a workpiece close at the end of open/close stroke of fingers, detecting performance of the combinations listed in the above table may be limited, depending on the hysteresis of an auto switch, etc.

Various auto switch applications are possible through different combinations of auto switch quantities and detecting positions.

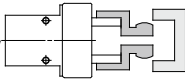
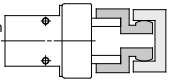
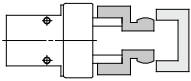
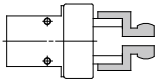
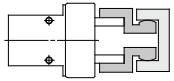
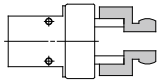
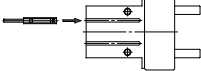
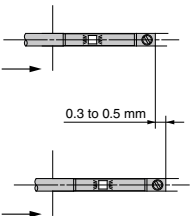
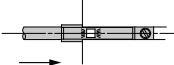
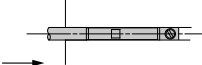
2) Detection when Gripping Interior of Workpiece

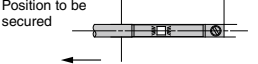
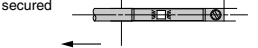
Detection example		1. Confirmation of fingers in reset position	2. Confirmation of workpiece held	3. Confirmation of workpiece released	
Position to be detected		Position of fingers fully closed 	Position when gripping a workpiece 	Position of fingers fully opened 	
Operation of auto switch		Auto switch turned ON when fingers return. (Light ON)	Auto switch turned ON when gripping a workpiece. (Light ON)	When a workpiece is not held (Abnormal operation): Auto switch to turn ON (Light ON)	
Detection combinations	One auto switch = One position, any of ①, ② and ③ can be detected.	●	●	●	
	Two auto switches = Two positions of ①, ② and ③ can be detected.	Pattern A	●	—	
		Pattern B	—	●	●
Pattern C	●	—	●		
How to determine auto switch installation position		Step 1) Fully close the fingers. 	Step 1) Position fingers for gripping a workpiece. 	Step 1) Fully open the fingers. 	
At no pressure or low pressure, connect the auto switch to a power supply, and follow the directions.		Step 2) Insert the auto switch into the auto switch installation groove in the direction shown in the following drawing.			
					
		Step 3) Move the auto switch in the direction of the arrow and fasten it at a position 0.3 to 0.5 mm beyond the position where the indicator light illuminates.	Step 3) Slide the auto switch in the direction of the arrow until the indicator light illuminates.		
					
		Step 4) Slide the auto switch further in the direction of the arrow until the indicator light goes out.			
Step 5) Move the auto switch in the opposite direction 0.3 to 0.5 mm in the direction indicated by the arrow from its location when the indicator light comes on again.		Position where light turns ON 			
					
		Position to be secured 			

Note 1) It is recommended that gripping of a workpiece be performed close to the center of the finger stroke.

Note 2) When holding a workpiece close at the end of open/close stroke of fingers, detecting performance of the combinations listed in the above table may be limited, depending on the hysteresis of an auto switch, etc.

MHK2 Series

Auto Switch Hysteresis

Auto switches have hysteresis similar to micro switches. Use the table below as a guide when adjusting auto switch positions, etc.

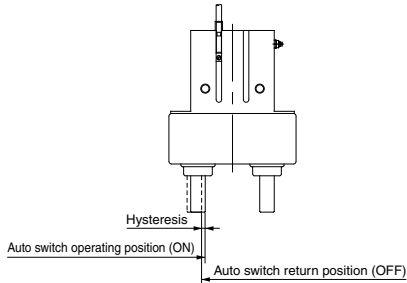

Auto switch Model	Max. hysteresis (mm)	
	D-M9□(V) D-M9□A(V) M9□W(V)	
MHK□2-12	0.1	
MHK□2-16	0.1	
MHK□2-20	0.3	
MHK□2-25	0.2	

Auto Switch Mounting

To set the auto switch, insert the auto switch into the installation groove of the gripper from the direction indicated in the following drawing. After setting the position, tighten the attached auto switch mounting set screw with a flat head watchmaker's screwdriver.

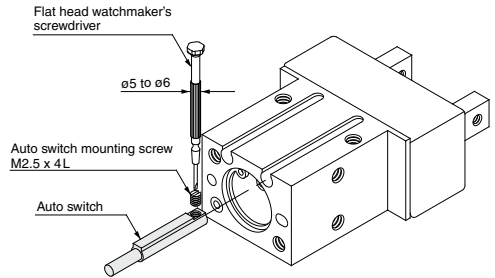

Note) Use a watchmaker's screwdriver with a grip diameter of 5 to 6 mm to tighten the auto switch mounting screw. Also, tighten with a torque of about 0.05 to 0.15 N·m, or about 0.05 to 0.10 N·m for D-M9□A(V).

Protrusion of Auto Switch from Edge of Body

- The amount of auto switch protrusion from the body's end surface is as shown in the table below.
- Use the table as a guideline for mounting.

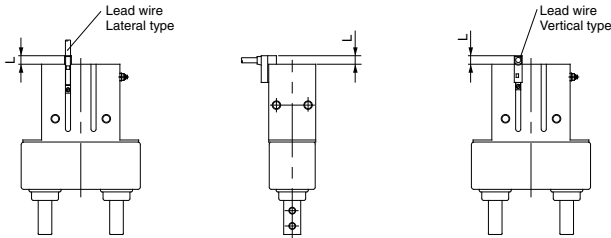

Note) When auto switch for MHK2, MHKL2 is set on mounting side as figure below, allow for at least 1 mm on mounting plate since the auto switch is protruded from edge of gripper.

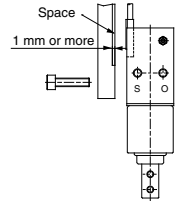

Air gripper model	Auto switch model Finger position	In-line electrical entry type		Perpendicular electrical entry type	
		D-M9□ D-M9□W	D-M9□A	D-M9□V D-M9□WV	D-M9□AV
MHK2-12□	Open	—	—	—	—
	Closed	3	5	—	3
MHK2-16□	Open	—	—	—	—
	Closed	3	5	1	3
MHK2-20□	Open	—	—	—	—
	Closed	1	3	—	1
MHK2-25□	Open	—	—	—	—
	Closed	2	4	—	2
MHKL2-12□	Open	—	—	—	—
	Closed	3	5	—	3
MHKL2-16□	Open	—	—	—	—
	Closed	3	5	1	3
MHKL2-20□	Open	—	—	—	—
	Closed	1	3	—	1
MHKL2-25□	Open	—	—	—	—
	Closed	1	3	—	1

Note) There is no protrusion if no values are entered in the table.

MHK2 Series

Made to Order: Individual Specifications 1



1 With Grease Nipple

Symbol
-X39

Lubrication from grease cup to interior is possible.

How to Order

MHK Standard part number - **X39**

With Grease Nipple ↓

Specifications

Bore size (mm)	16, 20, 25
Action	Double acting, Single acting (Normally open, Normally closed)
Lubricant grease	MHK standard grease (MH-G01)
Grease nipple position	Refer to the dimensions and figure below.
Specifications/dimensions other than the above	Same as the standard type

Note 1) Fill lubricant to the bearing from the grease cup in order to prevent foreign particles from getting in. The use of special grease MH-G01 for MHK is recommended.

Note 2) Not compatible with ø12.

Dimensions (Dimensions other than specified below are the same as the standard type.)

MHK2 Series MHKL2 Series

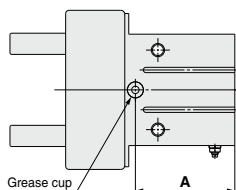

Model	(mm) A
MHK2-16□□□-X39	30.5
MHK2-20□□□-X39	37.5
MHK2-25□□□-X39	45
MHKL2-16□□□-X39	36
MHKL2-20□□□-X39	42
MHKL2-25□□□-X39	47.5

MHZ
MHF
MHL
MHR
MHK
MHS
MHC
MHT
MHY
MHW
-X□
MRHQ
MA
D-□

2 Grooves for Auto Switch on Both Sides

Symbol
-X41

It is possible to select the auto switch mounting side. A maximum of 4 auto switches are mountable.

How to Order

MHK2
MHKL2

— Bore size — — — — Switch type — — **X41**

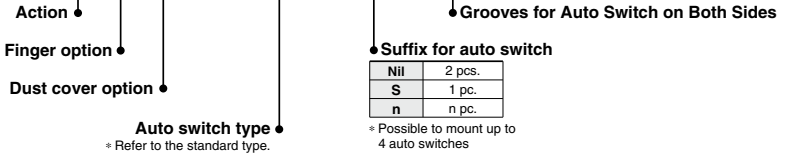

Specifications

Bore size (mm)	12, 16, 20, 25
Additional switch groove position	Refer to the dimensions and figures below.
Specifications/dimensions other than the above	Same as the standard type

Dimensions (Dimensions other than specified below are the same as the standard type.)

MHK2 Series MHKL2 Series

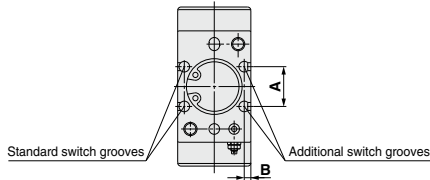

(mm)

Model	A	B
MHK2-12□□□-X41	10.4	1.8
MHKL2-12□□□-X41	10.4	1.8
MHK2-16□□□-X41	12.8	1.6
MHKL2-16□□□-X41	12.8	1.6

* Dimensions A and B of other models are same as standard switch grooves.



MHK2 Series Specific Product Precautions

Be sure to read this before handling the products.

Mounting Air Grippers/MHK2 Series

Possible to mount from 3 directions.

Axial Mounting (Body tapped)

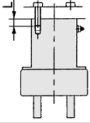

Model	Applicable bolts	Max. tightening torque N·m	Max. screw-in depth L mm
MHK2 -12□ MHKL2-12□	M3 x 0.5	0.88	6
MHK2 -16□ MHKL2-16□	M4 x 0.7	2.1	8
MHK2 -20□ MHKL2-20□	M5 x 0.8	4.3	10
MHK2 -25□ MHKL2-25□	M6 x 1	7.3	12

Vertical Mounting (Body tapped)

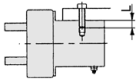

Model	Applicable bolts	Max. tightening torque N·m	Max. screw-in depth L mm
MHK2 -12□ MHKL2-12□	M3 x 0.5	0.59	4
MHK2 -12□ MHKL2-12□	M3 x 0.5	0.74	5
MHK2 -16□ MHKL2-16□	M4 x 0.7	0.88	4
MHK2 -16□ MHKL2-16□	M4 x 0.7	1.3	5
MHK2 -20□ MHKL2-20□	M5 x 0.8	3.3	8
MHK2 -25□ MHKL2-25□	M6 x 1	5.9	10

Lateral mounting (Body tapped and through-hole)

Body tapped

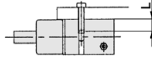

Model	Applicable bolts	Max. tightening torque N·m	Max. screw-in depth L mm
MHK2 -12□ MHKL2-12□	M4 x 0.7	2.1	8
MHK2 -16□ MHKL2-16□			8
MHK2 -20□ MHKL2-20□	M5 x 0.8	4.3	10
MHK2 -25□ MHKL2-25□	M6 x 1	7.3	12

●Body through-hole

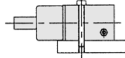

Model	Applicable bolts	Max. tightening torque N·m
MHK2 -12□ MHKL2-12□	M3 x 0.5	0.88
MHK2 -16□ MHKL2-16□		
MHK2 -20□ MHKL2-20□	M4 x 0.7	2.1
MHK2 -25□ MHKL2-25□	M5 x 0.8	4.3

How to Mount the Attachment to the Finger

- To mount the attachment to the finger, make sure to use a wrench to support the attachment so as not to apply undue strain on the finger.
- Refer to the table below for the proper tightening torque on the bolt used for securing the attachment to the finger.

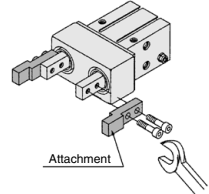

Model	Applicable bolts	Max. tightening torque N·m
MHK2 -12□ MHKL2-12□	M3 x 0.5	0.59
MHK2 -16□ MHKL2-16□		
MHK2 -20□ MHKL2-20□	M4 x 0.7	1.4
MHK2 -25□ MHKL2-25□	M5 x 0.8	2.8

MHZ

MHF

MHL

MHR

MHK

MHS

MHC

MHT

MHY

MHW

-X□

MRHQ

MA

D-□