

# Flow Sensor

## PFMV Series



### Suction verification of very small work pieces

This flow sensor enables precise suction.

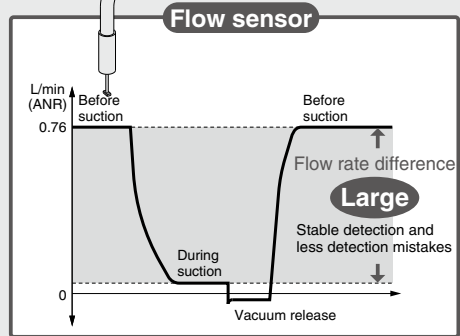
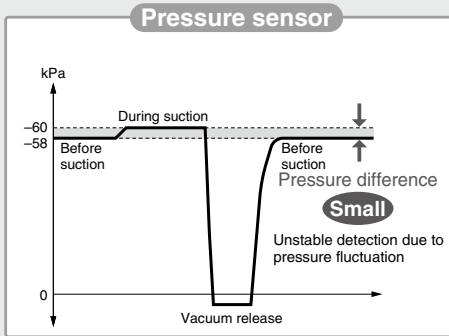

(Comparison under Nozzle diameter:  $\phi 0.3$ , Vacuum pressure:  $-60$  kPa)

- Repeatability:  $\pm 2\%$  F.S.

The taper-shaped flow passage in front of the sensor chip enables stable sensing.

Patent pending

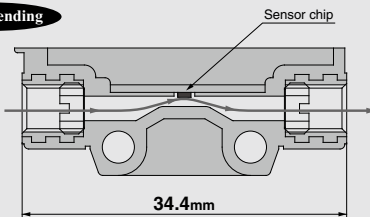

- Response speed: **5** ms or less
- Withstand pressure: **500** kPa
- Grease-free
- RoHS compliant
- Flexible cable

### Flow rate display function added

Setting/Display according to flow value is possible

Model	Rated flow range (L/min (ANR))								
	-3	-2	-1	-0.5	0	0.5	1	2	3
PFMV	505					0.5	1	2	3
	510					0.5	1	2	3
	530					0.5	1	2	3
	505F				0.5	1	2	3	
	510F			0.5	1	2	3		
	530F			0.5	1	2	3		

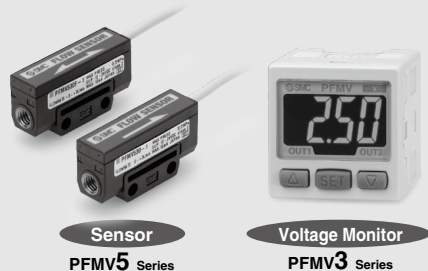

- PFM
- PFMB
- PFMC
- PFMV
- PF2A
- PF3W
- LFE
- PF2D
- IF

## Sensor

### Reduced piping space

Mountable in a space-saving location since the straight piping length is not required.

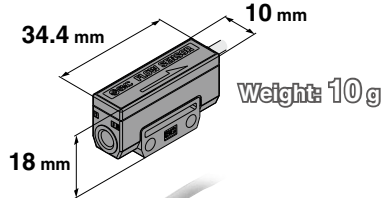
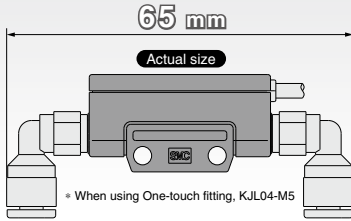

Flexible cable

Measurement flow range (L/min)	Model
0 to 0.5	PFMV505
0 to 1	PFMV510
0 to 3	PFMV530
-0.5 to 0.5	PFMV505F
-1 to 1	PFMV510F
-3 to 3	PFMV530F

### PFMV5 Series

## Voltage Monitor

### A full range of sensors (6 ranges) can be covered by one monitor.

No need to select the range of connected sensors (excluding external input).

Range for connected sensors must be selected in order to use the flow rate display function.



### Voltage display

Output voltage of the sensor is displayed.

- Set voltage range: 0.7 to 5.10 V
- Minimum unit setting: 0.01 V

\* Voltage value display and instantaneous flow rate display can be also selected.

### PFMV3 Series

### Connectors

Easy connection and removal of wiring

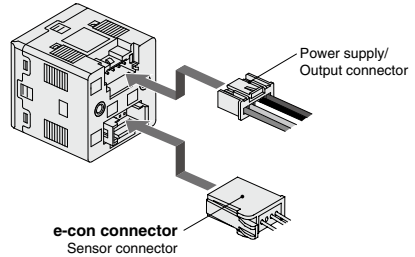

## Applications

### Suction verification of very small work pieces

- Suction of small components can be checked.
- Highly applicable to small nozzles
- Nozzle clogging and crushing detectable.

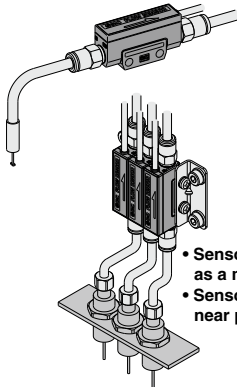

### Easy leak test

- Easily detects pin holes on molded parts.

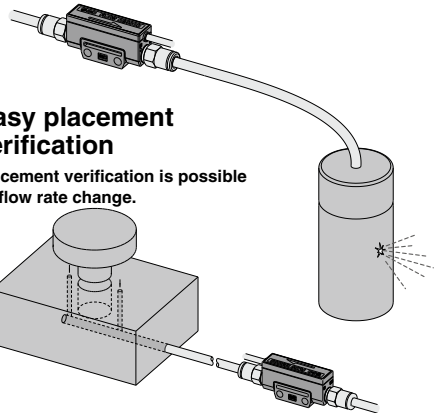

### Easy placement verification

- Placement verification is possible by flow rate change.

# Mountings

● Direct mount

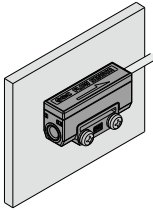

● Manifold mount

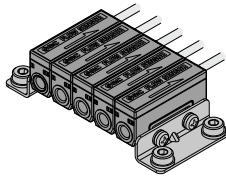

● One-side bracket mount

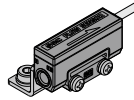

● Both-side bracket mount

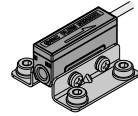

● Panel mount

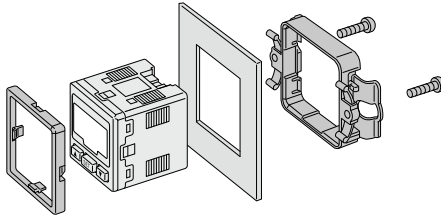

● Bracket mount

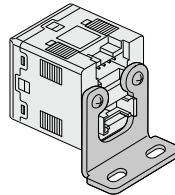

### Support for vertical and horizontal secure mounting

- A single panel opening is sufficient.
- Reduces panel fitting labor and enables space-savings.

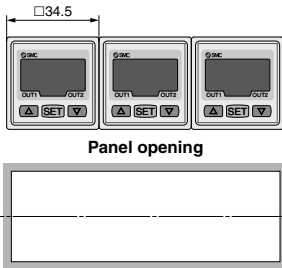

PFM
PFMB
PFMC
PFMV
PF2A
PF3W
LFE
PF2D
IF

# PFMV Series Model Selection

## Nozzle Diameter and Flow Rate Characteristics (Approximate values)

Use the following graphs as a reference to select sensor measuring range.

P2: Nozzle internal pressure



P1: Atmospheric pressure

### Nozzle Diameter – Flow Rate Characteristics (Vacuum)

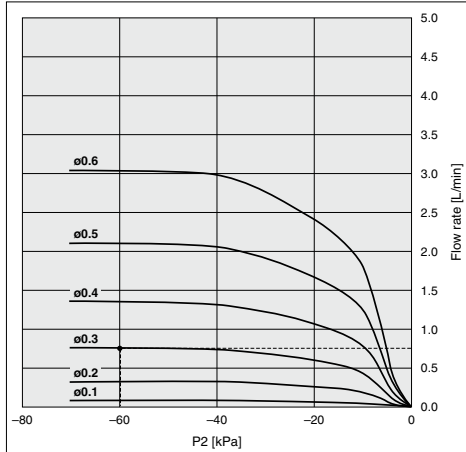

### Nozzle Diameter – Flow Rate Characteristics (Positive pressure)

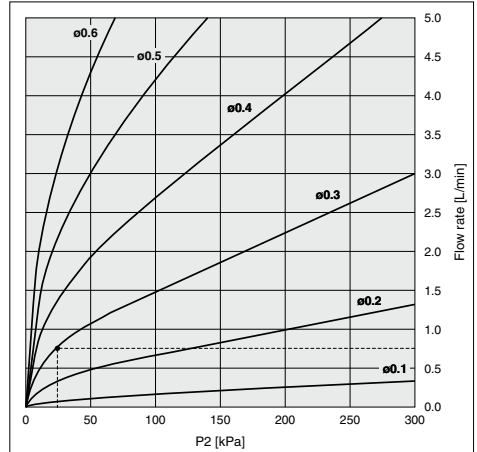

#### Example (Vacuum)

Selecting conditions:

Nozzle diameter: ø0.3    P1: 0 [kPa]  
P2: -60 [kPa]

The flow rate will be 0.7 to 0.8 [L/min] based on the graph.  
→ Select the PFMV510-1.

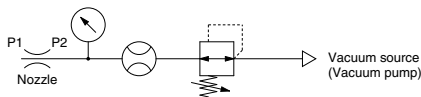

#### Example (Positive pressure)

Selecting conditions:

Nozzle diameter: ø0.3    P1: 0 [kPa]  
P2: 20 [kPa]

The flow rate will be 0.7 to 0.8 [L/min] based on the graph.  
→ Select the PFMV510-1.

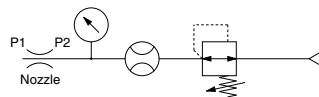

Note) Since the calculated value may not meet the approximate value due to leakage and pressure loss in the piping system, please check the result by using actual equipment.

# Flow Sensor

# PFMV5 Series



## How to Order



PFMV5 **05** - 1 -

### Measurement flow range

<b>05</b>	0.0 to 0.5 L/min
<b>10</b>	0.0 to 1.0 L/min
<b>30</b>	0.0 to 3.0 L/min
<b>05F</b>	-0.5 to 0.5 L/min
<b>10F</b>	-1.0 to 1.0 L/min
<b>30F</b>	-3.0 to 3.0 L/min

### Output specifications

<b>1</b>	Analog output (1 to 5 V)
----------	--------------------------

### Option (shipped together)

<b>Nil</b>	None
<b>A</b>	With L-type bracket

\* 2 L-type brackets (with 2 mounting screws) are included.

### Operation manual

<b>Nil</b>	With operation manual (Japanese and English)
<b>N</b>	None

## Option/Part No.

If a single option or manifold mounting are required, order sensors with the part numbers below separately.

Part no.	Stations	Note
<b>ZS-36-A1</b>	For 1 station (for single unit)	2 L-type brackets, 2 mounting screws M3 x 15L
<b>ZS-36-A2</b>	For 2 stations	2 L-type brackets, 2 mounting screws M3 x 25L
<b>ZS-36-A3</b>	For 3 stations	2 L-type brackets, 2 mounting screws M3 x 35L
<b>ZS-36-A4</b>	For 4 stations	2 L-type brackets, 2 mounting screws M3 x 45L
<b>ZS-36-A5</b>	For 5 stations	2 L-type brackets, 2 mounting screws M3 x 55L

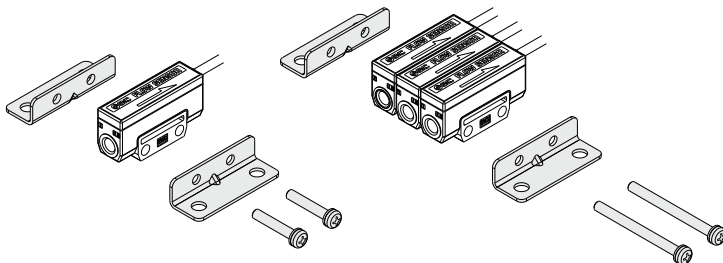

PFM
PFMB
PFMC
PFMV
PF2A
PF3W
LFE
PF2D
IF

## Compact Suction Filter

Part no.	Connection type
<b>ZFC050-M5X68</b>	IN/OUT: M5
<b>ZFC050-AU6X68</b>	IN: ø6 Barb fitting    OUT: M5
<b>ZFC-EL013-A</b>	Element (10 pcs.)



ZFC050-M5X68

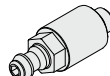

ZFC050-AU6X68



# PFMV5 Series

Refer to pages 202 and 203 for Flow Switch Precautions. For details about the Specific Product Precautions, refer to the Operation Manual on the SMC website, <http://www.smcworld.com> Click [here](#) for details.

## Specifications

Model	PFMV505	PFMV510	PFMV530	PFMV505F	PFMV510F	PFMV530F
Applicable fluid	Dry air, N <sub>2</sub> (JIS B 8932-1 1.1.2 to 1.6.2: 2003, ISO 8573-1 1.1.2 to 1.6.2)					
Rated flow range (Flow rate range) <small>Note 1)</small>	0 to 0.5 L/min	0 to 1 L/min	0 to 3 L/min	-0.5 to 0.5 L/min <small>Note 2)</small>	-1 to 1 L/min <small>Note 2)</small>	-3 to 3 L/min <small>Note 2)</small>
Accuracy	±5% F.S. <small>Note 3)</small>					
Repeatability	±2 F.S. <small>Note 3)</small>					
Pressure characteristics (0 kPa reference <small>Note 4)</small> )	±2% F.S. (0 to 300 kPa) ±5% F.S. (-70 to 0 kPa)					
Temperature characteristics (25°C reference)	±2% F.S. (15 to 35°C) ±5% F.S. (0 to 50°C)					
Rated pressure range <small>Note 5)</small>	-70 kPa to 300 kPa					
Operating pressure range <small>Note 6)</small>	-100 kPa to 400 kPa					
Proof pressure	500 kPa					
Analog output (Non-linear output)	Voltage output: 1 to 5 V, Output impedance: Approx. 1 kΩ					
Response time	5 ms or less (90% response)					
Power supply voltage	12 to 24 VDC ± 10% (with polarity protection)					
Current consumption	16 mA or less					
Environment	Enclosure	IP40				
	Fluid temperature	0 to 50°C (No freezing and condensation)				
	Operating temperature range	0 to 50°C (No freezing and condensation)				
	Stored temperature range	-10 to 60°C (No freezing and condensation)				
	Operating humidity range	35 to 85% R.H. (No condensation)				
	Stored humidity range	35 to 85% R.H. (No condensation)				
	Withstand voltage	1000 VAC for 1 minute between terminals and housing				
	Insulation resistance	50 MΩ or more (500 VDC measured via megohmmeter) between terminals and housing				
	Port size	M5 x 0.8 (Tightening torque: 1 to 1.5 N·m)				
Wetted parts material	PPS, Si, Au, Stainless steel 316, C3604 (Electroless nickel plating)					
Standards	CE UL, CSA RoHS					
Lead wire	Vinyl cabtire cord, 3 cores ø2.6, 0.15 mm <sup>2</sup> , 2 m					
Weight	10 g (excluding lead wire)					

Note 1) Flow rate in the specification is the value at standard condition.

Note 2) Analog output indicates 3 V when the flow rate is 0. When the flow direction is from IN to OUT, the output is changed to 5 V, and when it's from OUT to IN, the output is changed to 1 V.

Note 3) The unit % F.S. is based on the full scale of analog 4 V (1-5 V).

Note 4) 0 kPa indicates the atmospheric release.

Note 5) Pressure range that satisfies the product specifications

Note 6) Applicable pressure range

Note 7) For details about wiring, refer to the Operation Manual that can be downloaded from SMC website (<http://www.smcworld.com>).

Note 8) Any products with tiny scratches, smears, or display color variation or brightness which does not affect the performance are verified as conforming products.

## Internal Circuits and Wiring Examples

-1

### Analog voltage output

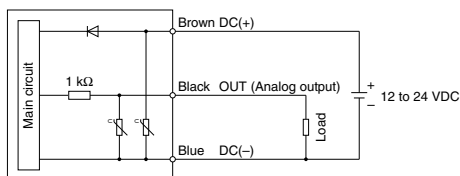

### Lead Wire Specifications

Conductor	Nominal cross section area	AWG26
	External diameter	0.58 mm
Insulator	External diameter	0.88 mm
	Colors	Brown, Blue, Black
Sheath	Material	Oil-resistant/Heat-resistant PVC
Finished external diameter		2.6

## Recommended Pneumatic Circuits

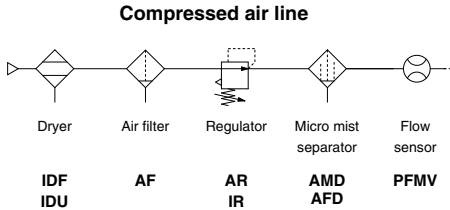

## Recommended Fittings

### One-touch Fitting/KQ2 Series

Type	Tubing O.D. (mm)	Port size	Model
Male connector	4	M5 x 0.8	KQ2H04-M5A
Male elbow			KQ2L04-M5A

### Miniature Fitting/M Series

Type	Tubing O.D. (mm)	Port size	Model
Barb fitting for nylon tube	4	M5 x 0.8	M-5AN-4
	6		M-5AN-6

## Wetted Parts Construction

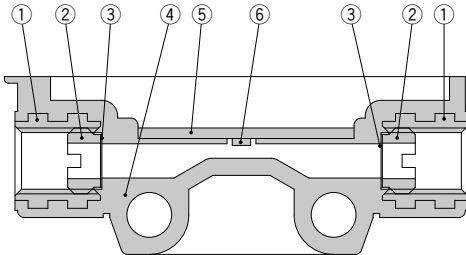

### Component Parts

No.	Description	Material
1	<b>Fitting for piping</b>	C3604 (Electroless nickel plating)
2	<b>Mesh holding screw</b>	
3	<b>Mesh</b>	Stainless steel 316
4	<b>Body</b>	PPS
5	<b>Print circuit board</b>	GE4F
6	<b>Sensor chip</b>	Si, Au

## Detection Principle

This MEMS sensor chip consists of upstream temperature measuring sensor (Ru) and downstream temperature measuring sensor (Rd), which are placed symmetrically from the center of a platinum thin film coated heater (Rh) mounted on a membrane, and an ambient temperature sensor (Ra) for measuring gas temperature.

The principle is shown as the diagram on the right. (a) When the gas is static, the temperature distribution of heated gas centered around Rh is uniform, and Ru and Rd have the same resistance. (b) When the gas flows from the left side, it upsets the balance of the temperature distribution of heated gas, and the resistance of Rd becomes greater than that of Ru.

The difference in resistance between Ru and Rd is proportional to the flow velocity, so measurement and analysis of the resistance can show the flow direction and velocity of the gas.

Ra is used to compensate the gas and/or ambient temperature.

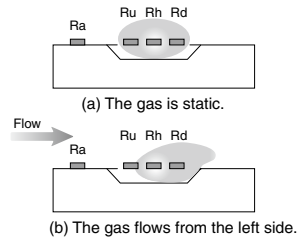

PFM

PFMB

PFMC

PFMV

PF2A

PF3W

LFE

PF2D

IF

# PFMV5 Series

## Analog Output (Non-linear output)

**PFMV505-1**

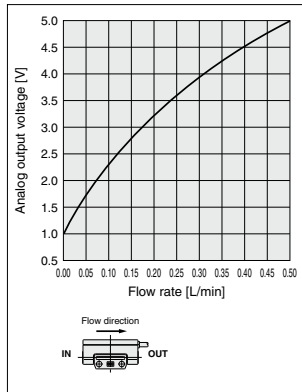

**PFMV510-1**

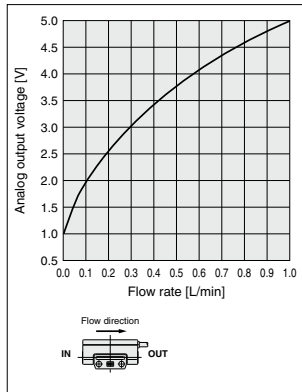

**PFMV530-1**

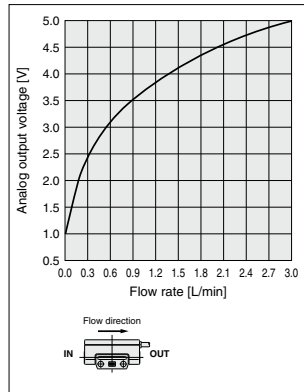

**PFMV505F-1**

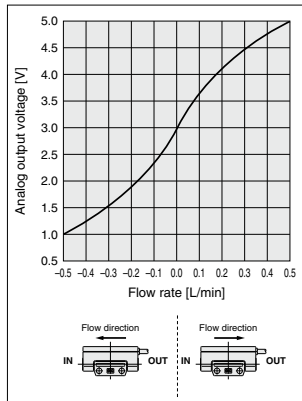

**PFMV510F-1**

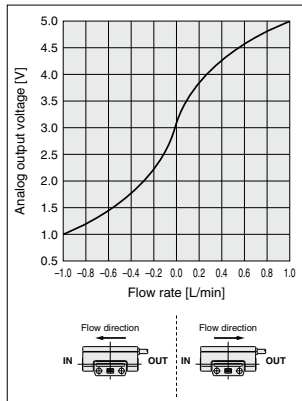

**PFMV530F-1**

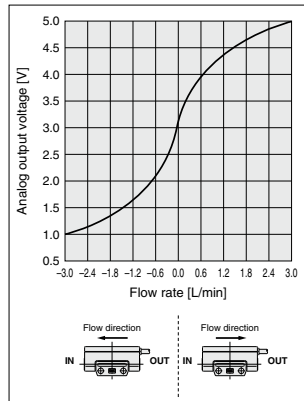

## Pressure Loss

**PFMV505(F)-1**

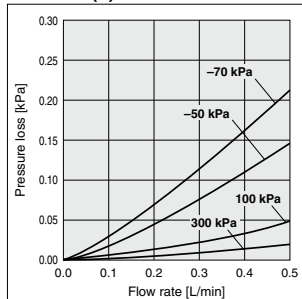

**PFMV510(F)-1**

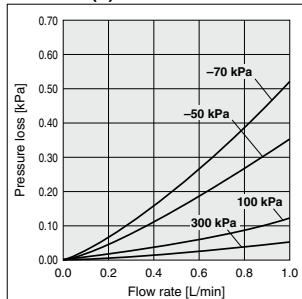

**PFMV530(F)-1**

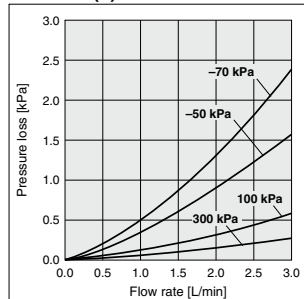



**Dimensions**

PFMV5□□-1

PFMV5□□F-1

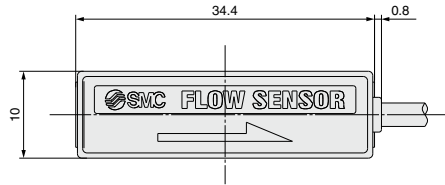

**Caution**  
 Apply a wrench only to the designated fitting part when installing the flow sensor in the system piping.

Tightening torque for fitting part 1.0 to 1.5N·m

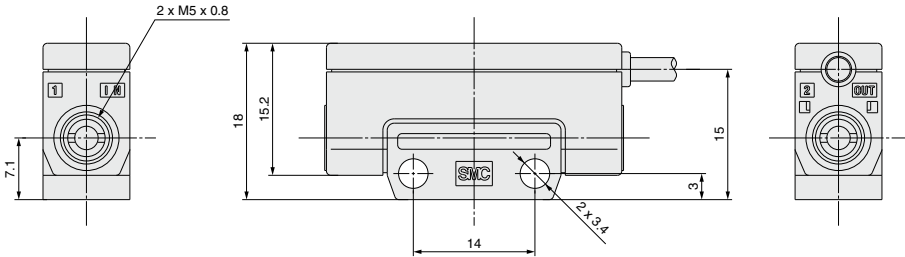

**One-side bracket**

**Both-side bracket**

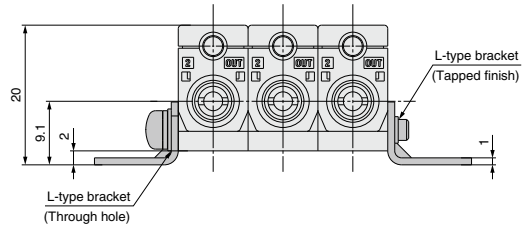
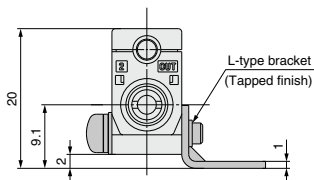
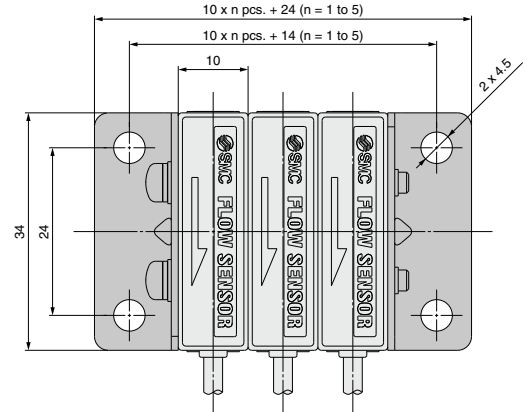
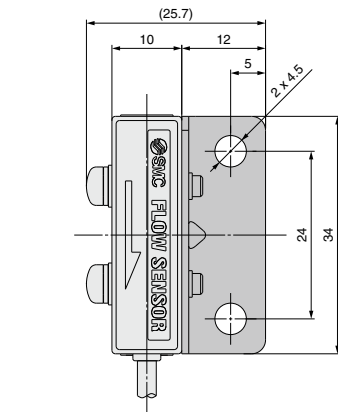

- PFM
- PFMB
- PFMC
- PFMV**
- PF2A
- PF3W
- LFE
- PF2D
- IF

The dimensions show the PFMV5□□-1. The PFMV5□□F-1 has the same dimensions.

# PFMV5 Series



## Suction Filter

### ZFC050-M5X68

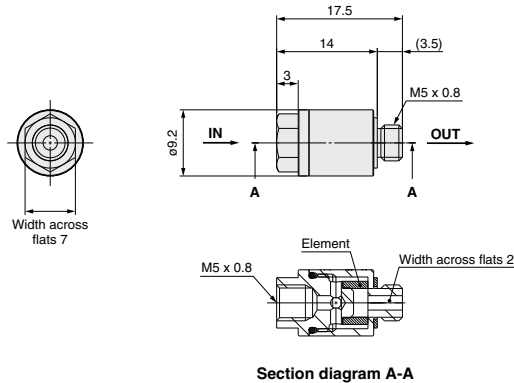

### ZFC050-AU6X68

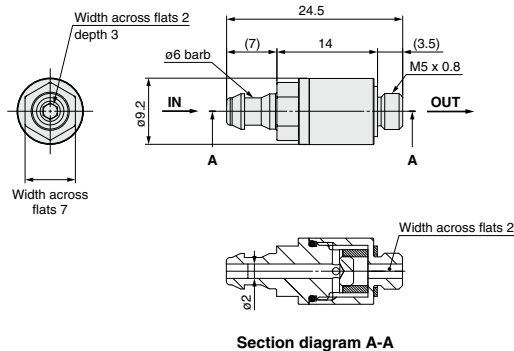

### Example of mounting to the flow sensor PFMV series (For suction verification)

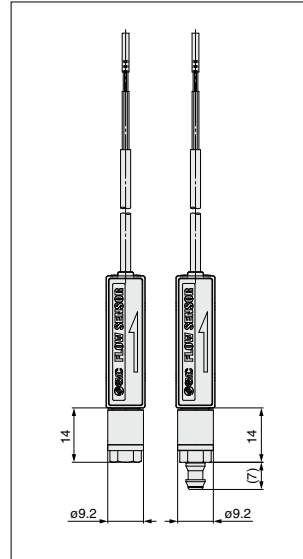

## Specifications

Filtration degree	3 $\mu\text{m}$ (Nominal)
Fluid	Air
Operating pressure range	-100 to 600 kPa
Ambient temperature	0 to 60°C (No freezing)
Applicable tubing material	soft nylon, Polyurethane
Applicable tubing O.D./I.D.	$\phi 6/\phi 4$

### Replacement element part no...ZFC-EL013-A

## ⚠ Caution

- To screw in OUT side port (M5 male thread), tighten by hand before giving it an additional 1/4 turn with a tightening tool.
- When replacing the element, remove the IN side body using the hexagon surface on the IN side, then replace the element. After replacing the element, tighten the IN side body with the tightening torque 0.5 to 0.7 N·m.
- As a rule, replace the element when the pressure drops by 20 kPa.
- The response time of the single flow sensor is 5 msec. However, take great care since the response may be delayed depending on the element clogged conditions.

# Voltage Monitor for PFMV5

# PFMV3 Series



## How to Order

### Output specifications

0	2 NPN outputs + 1 to 5 V output
1	2 NPN outputs + 4 to 20 mA output
2	2 NPN outputs + Auto-shift input
3	2 PNP outputs + 1 to 5 V output
4	2 PNP outputs + 4 to 20 mA output
5	2 PNP outputs + Auto-shift input

Note) Auto-shift, Auto-shift zero can be selected.

### Operation manual

Nil	With operation manual (Japanese and English)
N	None

### Calibration certificate

Nil	None
A	With calibration certificate

Note 1) The certificate is written in both English and Japanese. Please consult with us for other languages.

Note 2) Only the voltage monitor will be calibrated. Calibration will not be made to the flow rate display.

**PFMV3 0 0 - M L**

### Type

3	Remote display unit
---	---------------------

### Input specifications

Symbol	Content	Applicable remote type sensor unit
0	Voltage input	PFMV5□(F)-1-□□

### Unit specifications

Nil	With unit switch function <sup>Note 1)</sup>
M	Fixed SI unit <sup>Note 2)</sup>

Note 1) Since the unit for Japan is fixed to SI due to new measurement law, this option is for overseas.

Note 2) Fixed unit Voltage: V  
Instantaneous flow rate: L/min

### Option 1

Nil	None
L	Power supply/Output connector

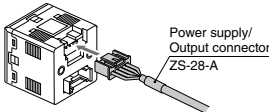

Note) Cable is shipped together, but not connected.

The PFMV3 series is a monitor that displays the output voltage of the PFMV5 series.

\* Voltage value display and instantaneous flow rate display can be selected.

## Option/Part No.

Description	Part no.	Note
Power supply/Output connector (2 m)	ZS-28-A	
Bracket	ZS-28-B	With M3 x 5 L (2 pcs.)
Sensor connector	ZS-28-C	1 pc.
Panel mount adapter	ZS-27-C	With M3 x 8 L (2 pcs.)
Panel mount adapter + Front protective cover	ZS-27-D	With M3 x 8 L (2 pcs.)

### Option 3

Nil	None
G	With sensor connector

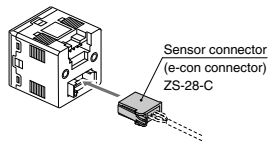

Note) Connector is shipped together, but not connected.

### Option 2

Nil	None
E	Bracket
B	Panel mount adapter
D	Panel mount adapter + Front protective cover

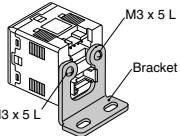
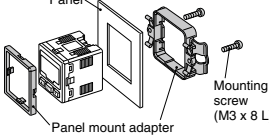
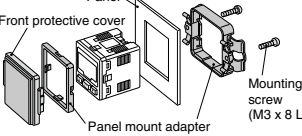
Note) Options are shipped together, but not assembled.

PFM

PFMB

PFMC

PFMV

PF2A

PF3W

LFE

PF2D

IF

# PFMV3 Series

Refer to pages 202 and 203 for Flow Switch Precautions. For details about the Specific Product Precautions, refer to the Operation Manual on the SMC website, <http://www.smcworld.com> Click [here](#) for details.

## Specifications

Model		Series PFMV3□□					
<b>Applicable sensor</b>		PFMV505	PFMV510	PFMV530	PFMV505F	PFMV510F	PFMV530F
<b>Flow rate</b>	<b>Rated range</b>	0 to 0.5 L/min	0 to 1 L/min	0 to 3 L/min	-0.5 to 0.5 L/min	-1 to 1 L/min	-3 to 3 L/min
	<b>Displayable range</b>	-0.025 to 0.525 L/min	-0.05 to 1.05 L/min	-0.15 to 3.15 L/min	-0.525 to 0.525 L/min	-1.05 to 1.05 L/min	-3.15 to 3.15 L/min
	<b>Settable range</b>	-0.025 to 0.525 L/min	-0.05 to 1.05 L/min	-0.15 to 3.15 L/min	-0.525 to 0.525 L/min	-1.05 to 1.05 L/min	-3.15 to 3.15 L/min
	<b>Minimum unit setting</b>	0.001 L/min	0.01 L/min		0.001 L/min	0.01 L/min	
<b>Voltage</b>	<b>Rated range</b>	1.00 to 5.00 V					
	<b>Display voltage range</b>	0.70 to 5.10 V: Voltages below 0.7 V displayed as "LLL", voltages above 5.10 V displayed as "HHH".					
	<b>Set voltage range</b>	0.70 to 5.10 V					
	<b>Minimum unit setting</b>	0.01 V					
<b>Indication unit</b> <small>Note 1)</small>	Voltage: V Instantaneous flow rate: L/min, CFH (ft <sup>3</sup> /h)						
<b>Power supply voltage</b>	12 to 24 VDC (±10%) (with polarity protection)						
<b>Current consumption</b>	50 mA or less						
<b>Hysteresis</b> <small>Note 2)</small>	Hysteresis mode: Variable, Window comparator mode: Variable						
<b>Switch output</b>	NPN or PNP open collector output: 2 outputs Max. load current: 80 mA, Max. load voltage 30 VDC (at NPN output), Residual voltage 1 V or less (at load current 80 mA), With short-circuit protection						
<b>Response time</b>	Switch output: 2 ms (10 ms, 50 ms, 0.5 s, 1 s can be selected.) <small>Note 3)</small>						
<b>Repeatability</b> <small>Note 4)</small>	±0.1% F.S., Analog output accuracy: ±0.3% F.S.						
<b>Analog output</b>	Voltage output: 1 to 5 VDC, Output impedance: Approx. 1 kΩ Current output: 4 to 20 mA DC, Max. load impedance: 600 Ω (at 24 VDC) Min. load impedance: 50 Ω, Accuracy: ±1% F.S. (relative to display value), Response: 0.1 s (90% response or less)						
<b>Display accuracy</b> <small>Note 4)</small>	±0.5% F.S. ± 1 digit						
<b>Display method</b>	3+1/2-digit, 7-segment LED 2-color display (Red/Green) Updated cycle: 10 times/sec						
<b>Status LED's</b>	OUT1: Lights up when output is turned ON (Green). OUT2: Lights up when output is turned ON (Red).						
<b>External input (Auto-shift input)</b> <small>Note 5)</small>	No-voltage input (Reed or Solid state), LOW level input 5 msec or more, LOW level 0.4 V or less						
<b>Enclosure</b>	IP40						
<b>Operating temperature range</b>	Operating: 0 to 50°C Stored: -10 to 60°C (No freezing and condensation)						
<b>Operating humidity range</b>	Operating, Stored: 35 to 85% R.H. (No condensation)						
<b>Withstand voltage</b>	1000 VAC for 1 minute between terminals and housing						
<b>Insulation resistance</b>	50 MΩ or more (500 VDC measured via megohmmeter) between terminals and housing						
<b>Temperature characteristics</b>	±0.5% F.S. or less (25°C reference)						
<b>Standards</b>	CE UL, CSA RoHS						
<b>Connection</b>	Power supply/Output connection: 5P connector, Sensor connection: 4P connector (For cable specifications, refer to page 303.)						
<b>Material</b>	Front case, Rear case: PBT						
<b>Weight</b>	30 g (without cable) 85 g (with cable)						

Note 1) When equipped with a unit switching function. (The SI unit (L/min or V) is fixed for types with no unit switching function.)

Note 2) Set to hysteresis mode at the time of shipment from the factory. Can be changed to window comparator mode using push-buttons.

Note 3) This is the response when the setting value is set to 90% to a 0 to 100% of step input.

Note 4) When the flow rate display function is selected, the repeatability and display accuracy should be exactly like the graph on page 300.

Note 5) Auto-shift function is turned OFF at the time of shipment from the factory. Use it after auto-shift function is turned ON using push-buttons.

Note 6) For details about wiring, refer to the Operation Manual that can be downloaded from SMC website (<http://www.smcworld.com>).

Note 7) Any products with tiny scratches, smears, or display color variation or brightness which does not affect the performance are verified as conforming products.

## Settable Range and Voltage Input Range

The settable rate range is the range that can be set in the switch.

The inputtable range is the range that satisfies the switch specifications (accuracy, linearity, etc.).

It is possible to set a value outside of the inputtable range if it is within the settable range, however, the specification is not guaranteed.

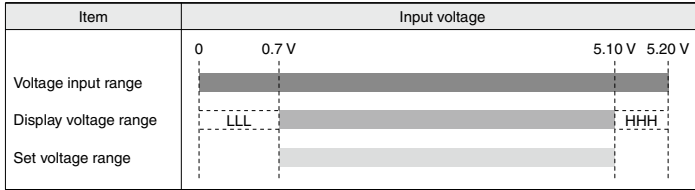

The settable rate range is the flow range that can be set in the switch.

The rated flow range is the flow rate range that satisfies the switch specifications (accuracy, linearity, etc.).

It is possible to set a value outside of the rated flow range if it is within the settable range, however, the specification is not guaranteed.

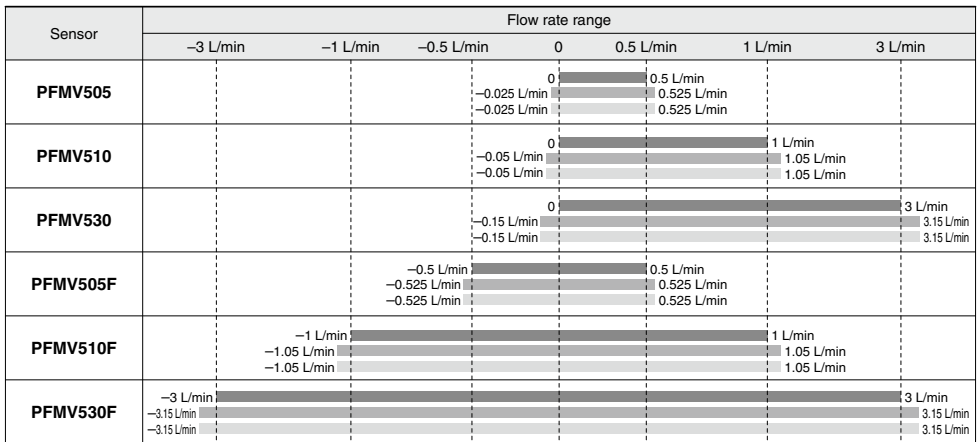

The values shown on the graph are the displayed flow rate range and set flow rate range when PFMV5 series and PFMV3 series are connected.

Rated flow range  
 Displayable flow range  
 Settable range

- PFM
- PFMB
- PFMC
- PFMV
- PF2A
- PF3W
- LFE
- PF2D
- IF

# PFMV3 Series

## Analog Output

1 to 5 VDC

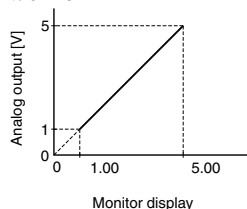

4 to 20 mA DC

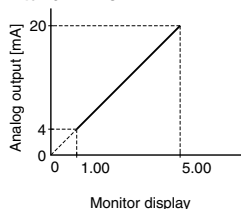

## Display Accuracy and Repeatability when Combined with PFMV5.

### PFMV530-1

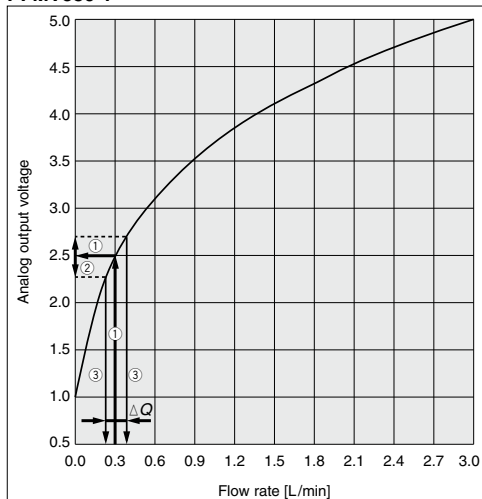

When the flow rate display function for the PFMV3 series is selected, calculate the repeatability from the analog output characteristics graph (page 294).

#### Example) For PFMV530-1 (0 to 0.3 L/min)

- ① When the actual flow rate is 0.3 L/min, the PFMV530-1 outputs approximately 2.5 V of analog voltage (Arrow ① in the graph on the left).
- ② The PFMV5 series has a repeatability of  $\pm 2\%$  F.S. ( $\pm 80$  mV) (Arrow ② in the graph on the left).
- ③ When this accuracy is converted to a flow rate, it becomes approximately  $\pm 3\%$  F.S. ( $\pm 0.09$  L/min), and this width becomes the repeatability when the flow rate is displayed (arrow ③, and the width of  $\Delta Q$ , in the graph on the left).

The flow rate display accuracy can be also calculated from the PFMV5 series accuracy ( $\pm 5\%$  F.S.).

**Internal Circuits and Wiring Examples**

**-0**  
NPN (2 outputs) + Analog voltage output

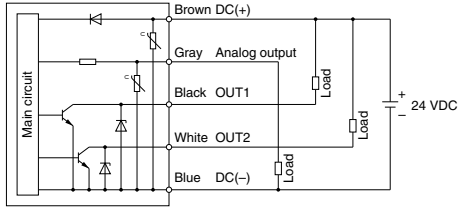

**-3**  
PNP (2 outputs) + Analog voltage output

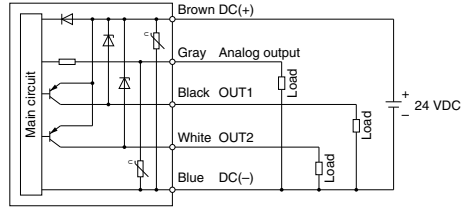

**-1**  
NPN (2 outputs) + Analog current output

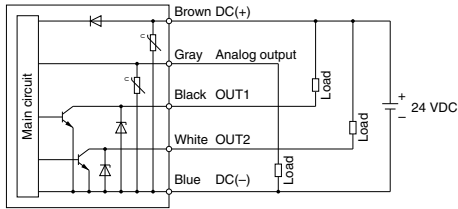

**-4**  
PNP (2 outputs) + Analog current output

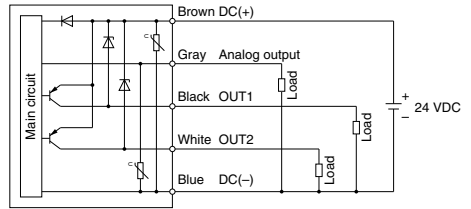

**-2**  
NPN (2 outputs) + External input

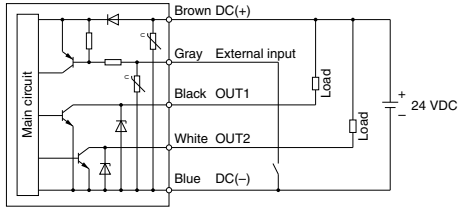

**-5**  
PNP (2 outputs) + External input

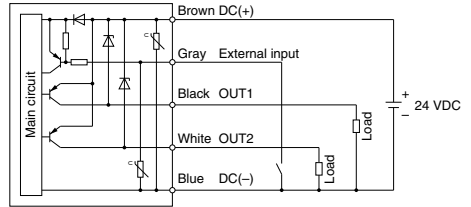

PFM

PFMB

PFMC

**PFMV**

PF2A

PF3W

LFE

PF2D

IF

# PFMV3 Series

## Dimensions

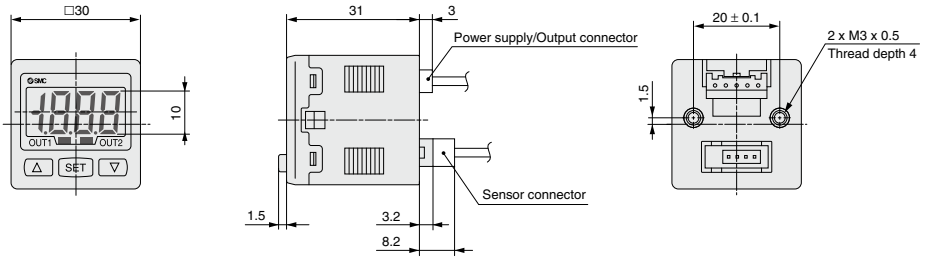

### Sensor connector (ZS-28-C)

Pin no.	Terminal name
1	DC (+)
2	N.C.
3	DC (-)
4	IN

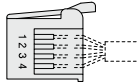

\* 1 to 5 V (Sensor output)

### With bracket

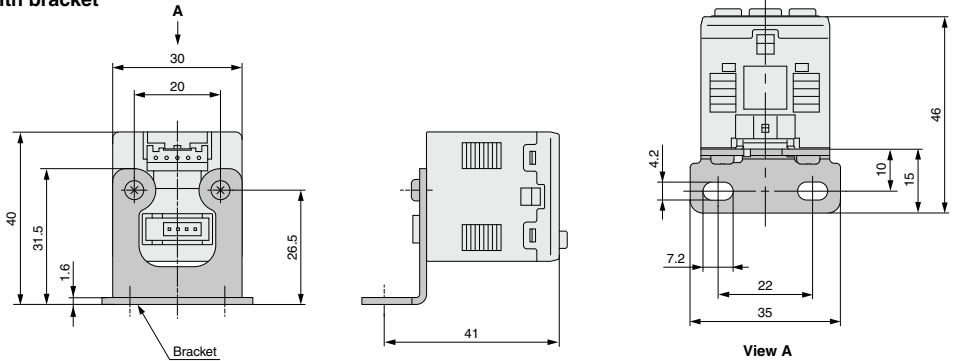

### With panel mount adapter

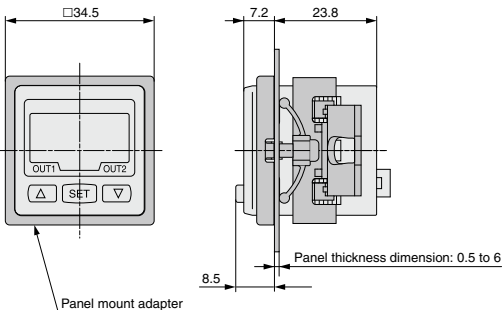

### With panel mount adapter + Front protective cover

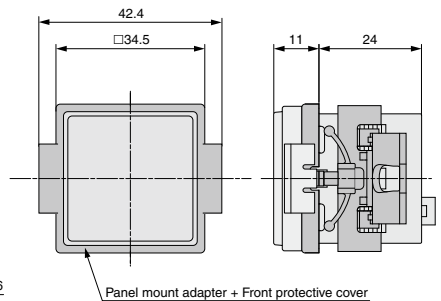



## Dimensions

### Panel fitting dimensions

#### Secure mounting of n pcs. (2 or more) switches (Horizontal)

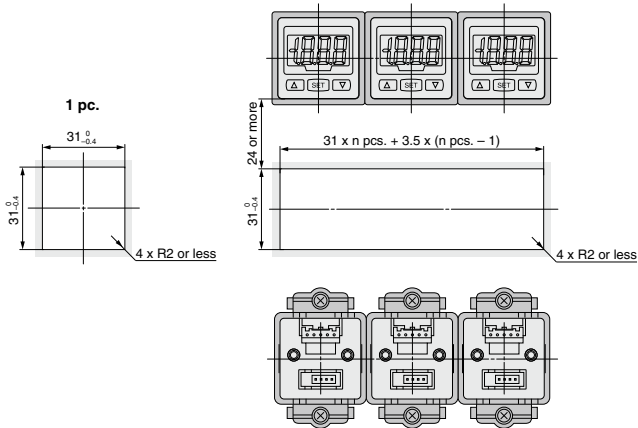

#### Secure mounting of n pcs. (2 or more) switches (Vertical)

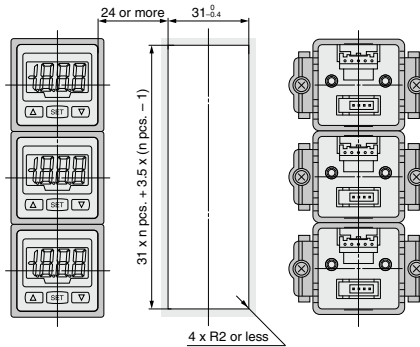

Note) If a bend (R) is used, limit it to R2 or less.

### Power supply/Output connector (ZS-28-A)

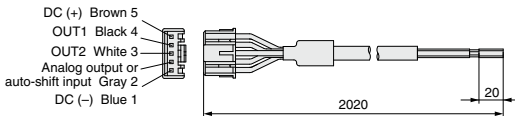

### Cable Specifications

Conductor	Nominal cross section area	0.2 mm <sup>2</sup>
	External diameter	0.58 mm
Insulator	External diameter	Approx. 1.12 mm
	Colors	Brown, Black, White, Gray, Blue
Sheath	Material	Oil-resistant PVC
Finished external diameter		ø4.1

PFM

PFMB

PFMC

PFMV

PF2A

PF3W

LFE

PF2D

IF

# PFMV3 Series

## Function Details

### ■ Output operation

The output operation can be selected from the following: Output (hysteresis mode and window comparator mode) corresponding to receiving voltage

At the time of shipment from the factory, it is set to hysteresis mode and reverse output.

### ■ Displayed values

The monitor receives the output voltage of the connected sensor and displays the received voltage. The unit is [V] and the voltage is displayed at 0.01 V intervals.

However, the voltage under 0.70 V is displayed as "LLL" and that of 5.1 V or more is displayed as "HHH".

Since the voltage is displayed on the monitor, it doesn't rely on the sensor range.

### ■ Indication color

The indication color can be selected for each output condition. The selection of the indication color provides visual identification of abnormal values. (The indication color depends on OUT1 setting.)

Green for ON, Red for OFF
Red for ON, Green for OFF
Red all the time
Green all the time

### ■ Setting of response time

The flow rate may change momentarily during transition between ON (open) and OFF (closed) of the valve. It can be set so that this momentary change is not detected.

2 ms
10 ms
50 ms
0.5 s
1 s

### ■ External input function

#### • Auto-shift

If the supply pressure of the air source fluctuates, the flow rate of vacuum generators such as an ejector also fluctuates. In that case, the switch may not operate properly when checking suction. Auto-shift is a function that corrects this fluctuation.

This function sends the output corresponding to the relative change based on the flow rate when the auto shift signal is input. Set value = 0.50: The switch turns ON and OFF when the set value increases by 0.5 V from the reference value.

Set value = -0.50: The switch turns ON and OFF when the set value decreases by 0.5 V from the reference value.

The reference value shows the voltage (= flow rate) when the auto-shift signal is input.

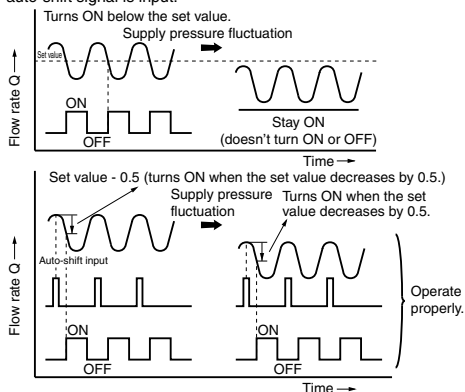

#### • Auto-shift zero

A function that displays the instantaneous flow rate as zero when the above auto-shift signal is input.

### ■ Wiring example when using auto-shift input

#### PFMV302

NPN open collector output with auto-shift input: 2 outputs

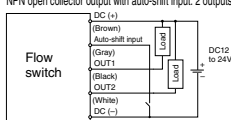

#### PFMV305

PNP open collector output with auto-shift input: 2 outputs

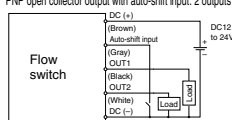

### ■ Auto-preset function

This is a function that calculates the set value automatically. When predetermined operation is conducted while the sensor is connected, the set value is calculated and decided automatically by changing the flow rate. (Fine adjustment is available.)

### ■ Selection of power-saving mode

The power-saving mode can be selected. With this function, if no buttons are pressed for 30 sec., it shifts to power-saving mode.

At the time of shipment from the factory, the product is set to the normal mode (the power-saving mode is turned off).

(When power-saving mode is activated, the decimal point flashes.)

### ■ Setting of secret code

The user can select whether a secret code must be entered to release key lock.

At the time of shipment from the factory, it is set such that the secret code is not required.

### ■ Peak/Bottom value indication

The maximum (minimum) voltage is detected and updated from when the power supply is turned on. In peak (bottom) value indication mode, this maximum (minimum) voltage is displayed.

### ■ Keylock function

Prevents operation errors such as accidentally changing setting values.

### ■ Error indication function

When an error or abnormality arises, the location and contents are displayed.

Description	Contents	Action
Input voltage error	The voltage outside the applicable indication range is input.	Check the input voltage.
System error	Possibility of internal circuit damage before factory adjustment.	Stop operation immediately and contact SMC.
	System error. Possibility of data memorizing failure or internal circuit damage.	Reset the unit, and carry out all settings again.

If the failure cannot be solved after the above instructions are performed, please contact SMC for investigation.

### ■ Reference value correcting function

If the displayed value doesn't become 1.00 due to the difference of the analog output of the connected sensors PFMV505, 510 and 530, the reference value will compulsively be set to 1.00.

When sensors PFMV505F, 510F and 530F are connected, the reference value will compulsively be set to 3.00.

Press the  $\Delta$  and  $\nabla$  buttons simultaneously for 1 second or more when the flow rate is zero (The display flashes when successfully corrected).

The effective range of the correcting function is from 1.00  $\pm$  0.2 V or 3.00  $\pm$  0.2 V. If the monitor is operated outside this range, it displays "Er4" and the reference value won't be corrected. Be sure to operate the monitor when the flow rate is zero.

When the PFM505 is used and the flow rate is applied, please pay attention to the following point. If this correcting function is applied around 3.00 V, the reference value will be changed and the function won't work properly. If the monitor is improperly operated, return the flow rate to zero and operate the monitor again.

And when the flow rate display is selected, the effective range of the correcting function is  $\pm$ 2% F.S. of the flow rate range.

### ■ Display Mode

Select whether to display the voltage or the instantaneous flow rate. The displayed flow rate value is for the standard condition (ANR), of 20°C, 1 atm, and 65% R.H.