



Operation Manual

PRODUCT NAME

Air cylinder

MODEL / Series / Product Number

C * J2 * * - * Z

SMC Corporation

Contents

| | |
|---|-----|
| Safety Instructions | P2 |
| 1. Product Specifications | P4 |
| 1-1. Specifications | |
| 2. Installation and Handling | P4 |
| 2-1. Air supply | |
| 2-2. Design | |
| 2-3. Mounting and Installation | |
| 2-4. Operating environment | |
| 2-5. Speed control | |
| 2-6. Allowable kinetic energy | |
| 2-7. Control of direction | |
| 2-8. Auto switches | |
| 3. Maintenance | P18 |
| 3-1. Checks | |
| 3-2. Consumable parts | |
| 4. Basic Circuit for Cylinder Operation | P19 |
| 5. Troubleshooting | P20 |
| 6. Construction | P23 |



Safety Instructions

These safety instructions are intended to prevent hazardous situations and/or equipment damage. These instructions indicate the level of potential hazard with the labels of "Caution," "Warning" or "Danger." They are all important notes for safety and must be followed in addition to International Standards (ISO/IEC)^{*1)}, and other safety regulations.

*1) ISO 4414: Pneumatic fluid power -- General rules relating to systems.

ISO 4413: Hydraulic fluid power -- General rules relating to systems.

IEC 60204-1: Safety of machinery -- Electrical equipment of machines .(Part 1: General requirements)

ISO 10218-1992: Manipulating industrial robots -Safety.

etc.



Caution

Caution indicates a hazard with a low level of risk which, if not avoided, could result in minor or moderate injury.



Warning

Warning indicates a hazard with a medium level of risk which, if not avoided, could result in death or serious injury.



Danger

Danger indicates a hazard with a high level of risk which, if not avoided, will result in death or serious injury.

Warning

1. The compatibility of the product is the responsibility of the person who designs the equipment or decides its specifications.

Since the product specified here is used under various operating conditions, its compatibility with specific equipment must be decided by the person who designs the equipment or decides its specifications based on necessary analysis and test results.

The expected performance and safety assurance of the equipment will be the responsibility of the person who has determined its compatibility with the product.

This person should also continuously review all specifications of the product referring to its latest catalog information, with a view to giving due consideration to any possibility of equipment failure when configuring the equipment.

2. Only personnel with appropriate training should operate machinery and equipment.

The product specified here may become unsafe if handled incorrectly.

The assembly, operation and maintenance of machines or equipment including our products must be performed by an operator who is appropriately trained and experienced.

3. Do not service or attempt to remove product and machinery/equipment until safety is confirmed.

1. The inspection and maintenance of machinery/equipment should only be performed after measures to prevent falling or runaway of the driven objects have been confirmed.

2. When the product is to be removed, confirm that the safety measures as mentioned above are implemented and the power from any appropriate source is cut, and read and understand the specific product precautions of all relevant products carefully.

3. Before machinery/equipment is restarted, take measures to prevent unexpected operation and malfunction.

4. Contact SMC beforehand and take special consideration of safety measures if the product is to be used in any of the following conditions.

1. Conditions and environments outside of the given specifications, or use outdoors or in a place exposed to direct sunlight.

2. Installation on equipment in conjunction with atomic energy, railways, air navigation, space, shipping, vehicles, military, medical treatment, combustion and recreation, or equipment in contact with food and beverages, emergency stop circuits, clutch and brake circuits in press applications, safety equipment or other applications unsuitable for the standard specifications described in the product catalog.

3. An application which could have negative effects on people, property, or animals requiring special safety analysis.

4. Use in an interlock circuit, which requires the provision of double interlock for possible failure by using a mechanical protective function, and periodical checks to confirm proper operation.



Safety Instructions

Caution

1. The product is provided for use in manufacturing industries.

The product herein described is basically provided for peaceful use in manufacturing industries.

If considering using the product in other industries, consult SMC beforehand and exchange specifications or a contract if necessary.

If anything is unclear, contact your nearest sales branch.

Limited warranty and Disclaimer/Compliance Requirements

The product used is subject to the following "Limited warranty and Disclaimer" and "Compliance Requirements".

Read and accept them before using the product.

Limited warranty and Disclaimer

1. The warranty period of the product is 1 year in service or 1.5 years after the product is delivered, whichever is first.*2)

Also, the product may have specified durability, running distance or replacement parts. Please consult your nearest sales branch.

2. For any failure or damage reported within the warranty period which is clearly our responsibility, a replacement product or necessary parts will be provided.

This limited warranty applies only to our product independently, and not to any other damage incurred due to the failure of the product.

3. Prior to using SMC products, please read and understand the warranty terms and disclaimers noted in the specified catalog for the particular products.

***2) Vacuum pads are excluded from this 1 year warranty.**

A vacuum pad is a consumable part, so it is warranted for a year after it is delivered.

Also, even within the warranty period, the wear of a product due to the use of the vacuum pad or failure due to the deterioration of rubber material are not covered by the limited warranty.

Compliance Requirements

1. The use of SMC products with production equipment for the manufacture of weapons of mass destruction (WMD) or any other weapon is strictly prohibited.

2. The exports of SMC products or technology from one country to another are governed by the relevant security laws and regulations of the countries involved in the transaction. Prior to the shipment of a SMC product to another country, assure that all local rules governing that export are known and followed.

1. Product Specifications

1-1. Specifications

| | | | |
|-------------------------------|--|----------|---------|
| Fluid | Air | | |
| Proof pressure | 1.0 MPa | | |
| Max. operating pressure | 0.7 MPa | | |
| Min. operating pressure | Ø6 | Ø10 | Ø16 |
| | 0.12 MPa | 0.06 MPa | |
| Ambient and fluid temperature | -10 to +70°C. -10 to +60°C with built-in magnet (No freezing) | | |
| Lubrication | Not required (non-lube) | | |
| Stroke length tolerance | +1.0 0 mm | | |
| Cushion | Rubber bumper | | |
| Piston speed | 50 to 750 mm/s | | |
| Allowable kinetic energy | Ø6 | Ø10 | Ø16 |
| | 0.012 J | 0.035 J | 0.090 J |

Use the actuator with allowable kinetic energy or less.



Warning

1) Confirm the specifications.

The product is designed for use only in industrial compressed air systems. Do not operate at pressures or temperatures etc., beyond the range of specifications, as this can cause damage or malfunction. (Refer to the specifications.)

Contact SMC in advance for non-industrial uses, or if using with a fluid other than compressed air. SMC do not guarantee against any damage if the product is used outside the specification range.

2) A deceleration circuit or shock absorber etc, may be required.

If the driven object moves at high speeds or is heavy, it will be unfeasible for the cylinders cushion to absorb the shock. Therefore a speed reduction circuit should be provided to reduce the speed before the thrust is applied to the cushion, or an external damper fitted to absorb the shock. Confirm the rigidity of the equipment after the measures above are taken.

2. Installation and Handling

2-1. Air supply

The compressed air supplied to the cylinder should be filtered by SMC AF series air filter and regulated to the specified set pressure by SMC AR series regulator.



Warning

- Use clean air.

Do not use compressed air that contains chemicals, synthetic oils including organic solvents, salts or corrosive gases etc., as this can cause damage or malfunction.



Caution

1) Install an air filter.

Install an air filter upstream near the valve. A filtration degree of 5 micron millimeter or less should be selected.

2) Take measure to ensure air quality, such as by installing an aftercooler, air dryer or water separator.

Compressed air that contains a large amount of moisture can cause malfunction of pneumatic equipment such as valves. Therefore, take appropriate measures to ensure air quality, such as providing an aftercooler, air dryer, or water separator.

3) Use the product within the specified fluid and ambient temperature range.

When operating at temperatures below 5°C, moisture in the circuit may freeze and cause breakage of seals or malfunction. Corrective measures should be taken to prevent freezing.

For compressed air quality, refer to Best Pneumatics No.5.

4) Lubrication of non-lubricating cylinder

Install a lubricator in the circuit, and use Class 1 turbine oil (with no additive) ISO VG-32. Stopping lubrication later may lead to malfunction because the new lubricant will displace the original lubricant. Therefore, lubrication must be continued once it has been started.

2-2. Design



Warning

1) There is a possibility of dangerous sudden action by cylinders if sliding parts of machinery are twisted due to external forces, etc.

In such cases, human injury may occur; e.g., by catching hands or feet in the machinery, or damage to the machinery itself may occur. Therefore, the machine should be designed to operate smoothly and avoid such dangers.

2) If there is a chance that the product will pose a hazard to humans, install a protective cover.

If the moving portion of the product will pose a hazard to humans or will damage machinery or equipment, a construction that prevents direct contact with those areas must be provided.

3) Be certain that the secured portions will not loosen.

When the product operates with high frequency or is installed where there is a lot of vibration, ensure that all parts remain secure.

4) Design the system so that it will not apply any external force over the maximum to the product.

The product can break, causing a risk of injury to personnel or damage to equipment.

5) The cylinder generates a large force. Install on a sufficiently rigid mounting base, taking this force into consideration.

There is a risk of injury to personnel or damage to equipment.

6) Consider the possibility of a reduction in the circuit air pressure that could be caused by a power source related malfunction.

There is a danger of workpieces dropping if there is a decrease of thrust due to a drop in circuit pressure caused by a power source malfunction, etc. Therefore, safety equipment should be installed to prevent damage to machinery and/or injury to personnel. Suspension equipment and lifting devices also require measures to prevent dropping.

7) Consider the possibility of power source related malfunctions.

For equipment that relies on power sources such as compressed air, electricity, or hydraulic pressure, countermeasures should be adopted to prevent the equipment from causing a hazard to personnel or damage to the equipment in the event of malfunction.

8) Consider emergency stop.

Devise a safety system so that if a person engages the emergency stop, or if a safety device is tripped during a system malfunction such as a power outage, the movement of the cylinder will not cause a hazard to humans or damage the equipment.

9) Consider the action when operation is restarted after an emergency stop or abnormal stop.

Design the machinery so that injury to personnel or equipment damage will not occur upon the restart of the operation. Install manually controlled equipment for safety when the actuator has to be reset to the starting position.

10) Intermediate stop

It is difficult for this product to make a piston stop at the required intermediate position accurately and precisely by a 3 position closed center type directional control valve, due to the compressibility of air. Furthermore, since valves and cylinders are not guaranteed for zero air leakage, it may not be possible to hold a stopped position for extended periods of time. Contact SMC if it is necessary to hold the stopped position for extended periods of time.

 **Caution**

- 1) Operate the product within a range so that the piston will not collide with the cover and be damaged at the stroke end.**

If the piston with inertia force is stopped by colliding with the cover at the stroke end, operate the cylinder within a range that will not cause damage. Refer to 2-6. Allowable kinetic energy (Page 11)

- 2) Avoid having a large gap between the clevis and mating bushing, as this exposes the pin to a bending load.**

- 3) Do not let foreign matter such as cutting chips get into the product from the suction port.**

- 4) Do not touch the cylinder during high speed and high frequency operation**

When the cylinder is operating at a high speed and high frequency, the surface temperature of the cylinder tube increases, and may cause injury to personnel.

- 5) Do not use the air cylinder as an air-hydro cylinder.**

If the working fluid of the air cylinder is turbine oil, oil leakage can result.

- 6) Grease is applied to cylinder.**

- 7) The base oil of grease may seep out.**

The base oil of grease in the cylinder may seep out of the tube, cover, crimped part or rod bushing depending on the operating conditions (ambient temperature 40 °C or more, pressurized condition, low frequency operation).

2-3. Mounting and Installation

- 1) There is a tolerated location diameter at the base of the cover mounting threads specifically for accurate alignment when mounting.

Caution

- 1) Do not apply excessive lateral load to the piston rod.

The bold solid lines in Fig. 1 show the allowable lateral load on the cylinder for a certain stroke length.

When 100mm or more stroke is used, the installation of a guide in the moving direction of the product is recommended.

Refer to 2-6. Allowable kinetic energy.(Page 11)

Allowable lateral load at the rod end

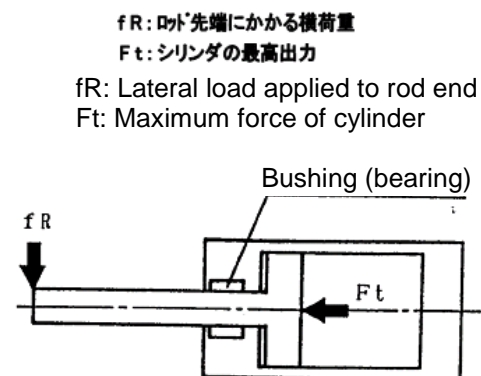
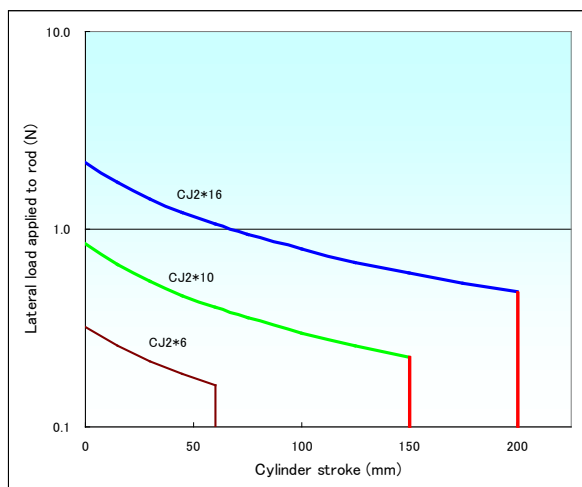

Fig. 1 Allowable lateral load applied to rod end

- 2) Make sure to connect the piston rod and the load so that their axial centers and movement directions match.

If they do not match, stress could be applied to the rod and the cylinder tube, causing wear to the inner surface of the cylinder tube, the bushing, the rod surface, and the seals may become damaged.

- 3) When mounting the cylinder, do not apply a lateral load to the rod. If a lateral load is unavoidable, keep the lateral load applied to the bushing 1/40 or less of the cylinder force.

- 4) When aligning the mounting bracket of work pieces transferred on the rail and the piston rod of the fixed cylinder (foot type or flange type) which operates the work pieces, check the centers are aligned when the piston rod is extended and retracted even if the cylinder operates normally.

- 5) When an external guide is used, connect the piston rod end and the load in such a way that there is no interference at any point within the stroke.

6) Do not apply any torque to the cover jointed part.

The rod cover and head cover have wrench flats. When installing the product, secure the cover of tightening side and apply appropriate tightening torque to mounting nuts, or to the body of the cover of tightening side.

Do not secure the cover of the other side of tightening, tighten mounting nuts or apply tightening torque to the body of the cover of the other side of tightening.

Excessive torque will reduce the clearance between the piston rod and bushing, causing operational failure. Use the appropriate torque given in Table 1 below.

Table 1 Appropriate tightening torque (Unit: Nm)

| Bore size | Thread diameter | Torque |
|-----------|-----------------|--------------|
| Ø6 | M6x1.0 | 2.1 to 2.5 |
| Ø10 | M8x1.0 | 5.9 to 6.4 |
| Ø16 | M10x1.0 | 10.8 to 11.8 |

7) Do not strike or grasp the sliding parts of the cylinder tube and piston rod with other objects.

Cylinder bores are manufactured to precise tolerances, even a slight deformation may cause malfunction.

Moreover, scratches or dents, etc. in the piston rod may lead to damaged seals and cause air leakage.

8) Prevent the seizure of rotating parts.

Prevent the seizure of rotating parts (pins, etc.) by applying grease.

9) Do not use the product until you have verified that the equipment can operate properly.

Verify correct mounting by function and leak tests after compressed air and power are connected following installation or repair.

10) Prevent foreign matter such as cutting chips getting into the product from the suction port.

When the product is installed on site, the debris from drilling mounting holes could get in the supply port of the product. Take sufficient care to prevent this.

2-4. Operating environment

Warning

- 1) Do not use in environments where there is a danger of corrosion.
- 2) Install a cover over the rod if it is used in an area that is dusty, or in an environment in which water or oil splashes on the cylinder.

Contact SMC if the operating location contains a lot of dust.

3) Avoid storing the product in humid conditions.

Store the product with the piston rod retracted and avoid humidity, in order to prevent generation of rust.

Caution

1) Preparation before piping

Before piping is connected, the pipe should be thoroughly blown out with air (flushing) or washed to remove chips, cutting oil and other debris from the inside.

2) Wrapping of sealant tape

When screwing piping or fittings into ports, ensure that chips from the pipe threads or sealing material do not enter the piping.

If sealant tape is used, leave 1.5 to 2 thread ridges exposed at the end of the threads.

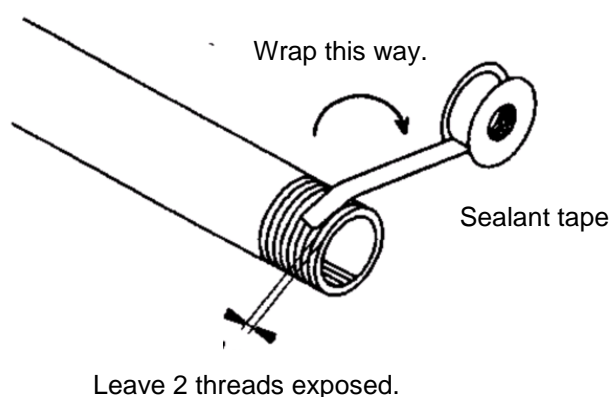

Fig. 2 Sealant tape

2-5. Speed control

When setting the piston speed, install SMC AS series speed controller near the air supply port and adjust to the specified speed. There are two methods of speed adjustment, one is to restrict air supplied to the product, and the other is to restrict air exhausted from the product. Normally, the latter method should be adopted.

Caution

Use a speed controller to adjust the cylinder drive speed, gradually increasing from a low speed to the desired speed setting.

2-6. Allowable kinetic energy

The applied kinetic energy must be within the allowable value when an inertial load is actuated.

Please refer to "Fig.1 Allowable lateral load applied to rod end" (Page 8)

Table 2 Operating range and kinetic energy

| Bore size | Ø6 | Ø10 | Ø16 |
|--------------------------|--------|---------|---------|
| Allowable kinetic energy | 0.12 J | 0.035 J | 0.090 J |



Warning

Operate the actuator with allowable kinetic energy (Table 2) or less.

Operation with a kinetic energy over the allowable value shown can break the product and cause injury to personnel or damage to equipment. If excessive kinetic energy is expected, install an external absorber to prevent impact to the body of the product. In this case, confirm the rigidity of the equipment carefully.

2-7. Control of direction

To switch the operating direction of the cylinder, mount an applicable solenoid valve selected from SMC's range of solenoid valves.



Warning

1) Design a circuit to prevent sudden action of a driven object.

When the product is actuated by an exhaust center type directional control valve or when one side of the piston is pressurized with air exhaust, such as when the product is started after the exhaust of the residual pressure from the circuit, driven objects may act suddenly at high speed. In such cases, injury may occur, such as hands or feet getting caught in the machinery, or damage to the machinery itself may occur. Design the machinery using equipment to prevent sudden action.

2) Intermediate stop

It is difficult for this product to make a piston stop at the required intermediate position accurately and precisely by a 3 position closed center type directional control valve, due to the compressibility of air.

Furthermore, since valves and cylinders are not guaranteed for zero air leakage, it may not be possible to hold a stopped position for extended periods of time. Contact SMC if it is necessary to hold the stopped position for extended periods of time.

2-8. Auto switches

When an auto switch is mounted or its set position is changed, refer to pages 11 to 17.



Caution

- Use a specific mounting bracket (Table 3 on page 12.) and mount the product so that the band of the bracket will be perpendicular to the stroke of the product.
- Tighten mounting screws to the appropriate torque.
- The auto switch can only be used for cylinders with a built-in magnet for auto switch (e.g. CDJ2).
- The mounting of the switch is limited depending on stroke. (See Table 4 on page 15.)

Table 3 Auto Switch Mounting Bracket / Part No.

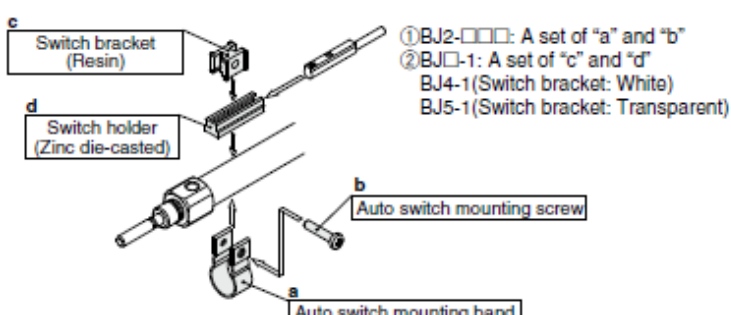
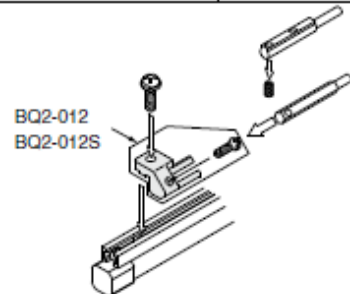
| Auto switch mounting | Auto switch model | Bore size (mm) | |
|---|---|---|---------------------------------------|
| | | 10 | 16 |
| Band mounting | D-M9□ D-M9□V D-M9□W D-M9□WV D-A9□ D-A9□V | Note 1) BJ6-010 | Note 1) BJ6-016 |
| | D-M9□A D-M9□AV | Note 2) BJ6-010S | Note 2) BJ6-016S |
| |  <p>①BJ2-□□□: A set of "a" and "b" ②BJ□-1: A set of "c" and "d" BJ4-1(Switch bracket: White) BJ5-1(Switch bracket: Transparent)</p> | | |
| D-C7□/C80 D-C73C/C80C D-H7□/H7□W D-H7BA/H7NF | BJ2-010 | BJ2-016 | |
| Rail mounting | | Note 3), Note 4) BQ2-012, BQ2-012S | Note 3), Note 4) BQ2-012, BQ2-012S |
| | D-M9□ D-M9□V D-M9□W D-M9□WV D-M9□A Note 4) D-M9□AV Note 4) D-A9□ D-A9□V |  <p>BQ2-012 BQ2-012S</p> | |

Note 1) Set part number which includes the auto switch mounting band (BJ2-□□□) and the holder kit (BJ5-1/Switch bracket: Transparent).

Since the switch bracket (made from nylon) are affected in an environment where alcohol, chloroform, methylamines, hydrochloric acid or sulfuric acid is splashed over, so it cannot be used. Please consult SMC regarding other chemicals.

Note 2) Set part number which includes auto switch mounting band (BJ2-□□□S) and the holder kit (BJ4-1/Switch bracket: White).

Avoid the indicator LED for mounting the switch bracket. As the indicator LED is projected from the switch unit, indicator LED may be damaged if the switch bracket is fixed on the indicator LED.

Note 3) When the cylinder is shipped, the auto switch mounting bracket and the auto switch will be included.

Note 4) For D-M9□A(V), order the BQ2-012S, which uses stainless steel mounting screws.

[Stainless Steel Mounting Screw]

The following stainless steel mounting screw kit is available. Use it in accordance with the operating environment. (Since the auto switch mounting bracket is not included, order it separately.)

BBA4: For D-C7/C8/H7 types

Note 5) Refer to page 1358 in Best Pneumatics No. 2 for details on the BBA4.

The above stainless steel screws are used when a cylinder is shipped with the D-H7BA auto switch. When only an auto switch is shipped independently, the BBA4 is attached.

[Reference] Auto switch mounting brackets using stainless steel screws are available for stainless steel cylinder CJ5.

Auto Switch Mounting Brackets for CJ5/Part No.

| Bore size (mm) | Auto switch mounting bracket part no. | Note |
|----------------|---------------------------------------|--------------------------------|
| 10 | BJ2-010S | Stainless steel mounting screw |
| 16 | BJ2-016S | |

Auto Switch Proper Mounting Position (Detection at stroke end) and Its Mounting Height

Solid state auto switch

<Band mounting>

D-M9□
D-M9□W
D-M9□A

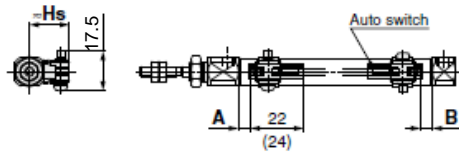

(): Dimension of the D-M9□A.
A and B are the dimensions from the end of the head cover/rod cover to the end of the auto switch.

D-M9□V
D-M9□MV
D-M9□AV

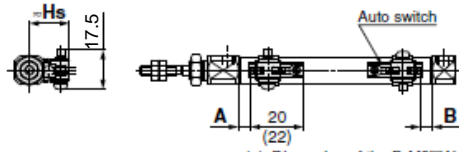

(): Dimension of the D-M9□AV.
A and B are the dimensions from the end of the head cover/rod cover to the end of the auto switch.

D-H7□
D-H7□W
D-H7BA
D-H7NF
D-H7C

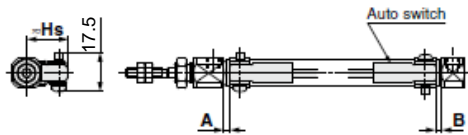

Reed auto switch

<Band mounting>

D-A9□

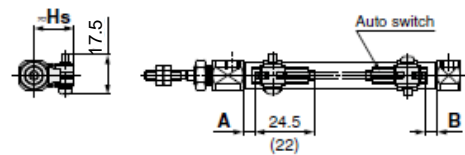

(): Dimension of the D-A96.
A and B are the dimensions from the end of the head cover/rod cover to the end of the auto switch.

D-A9□V

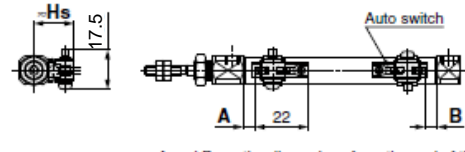

A and B are the dimensions from the end of the head cover/rod cover to the end of the auto switch.

D-C7□/C80
D-C73C□/C80C

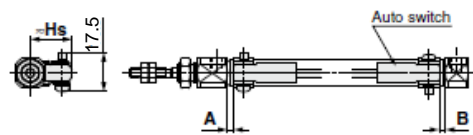

Auto Switch Proper Mounting Position

(mm)

| Auto switch model | Band mounting | | | | | | | |
|-------------------|---|-----------|-----------------|-----------|------------------------------------|-----|--|-----|
| | D-M9□ D-M9□V D-M9□W D-M9□WV D-M9□A D-M9□AV | | D-A9□ D-A9□V | | D-C7□ D-C80 D-C73C D-C80C | | D-H7□ D-H7C D-H7NF D-H7□W D-H7BA | |
| Bore size (mm) | A | B | A | B | A | B | A | B |
| 10 | (5) 6 | (5) 6 | (1) 2 | (1) 2 | 2.5 | 2.5 | 1.5 | 1.5 |
| 16 | (5.5) 6.5 | (5.5) 6.5 | (1.5) 2.5 | (1.5) 2.5 | 3 | 3 | 2 | 2 |

* The values in () are measured from the end of the auto switch mounting bracket.

Auto Switch Mounting Height

(mm)

| Auto switch model | Band mounting | | | | | |
|-------------------|------------------------------------|--|---|------------------|-------|----------------|
| | D-M9□ D-M9□W D-M9□A D-A9□ | D-M9□V D-M9□WV D-M9□AV D-A9□V | D-C7□/C80 D-H7□/H7□W D-H7NF D-H7BA | D-C73C D-C80C | D-H7C | D-A7□ D-A80 |
| Bore size (mm) | Hs | Hs | Hs | Hs | Hs | Hs |
| 10 | 17 | 18 | 17 | 19.5 | 20 | 16.5 |
| 16 | 20.5 | 21 | 20.5 | 23 | 23.5 | 19.5 |

Auto Switch Proper Mounting Position (Detection at stroke end) and Its Mounting Height

<Rail mounting>

D-M9□
D-M9□W
D-M9□A

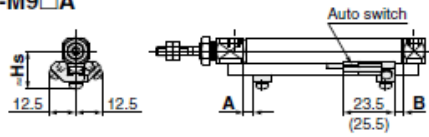

() : Dimension of the D-M9□A.

D-M9□V
D-M9□WV
D-M9□AV

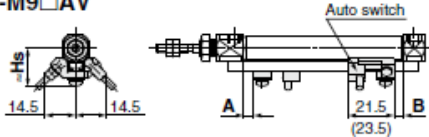

() : Dimension of the D-M9□AV.

D-F7□/J79
D-F7□W/J79W
D-F79F/F7BA

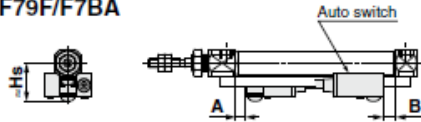

D-F7□V/F7□WV
D-F7BAV
D-J79C

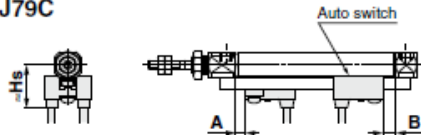

<Rail mounting>

D-A9□

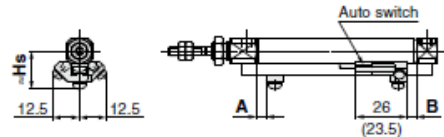

() : Dimension of the D-A96.

D-A9□V

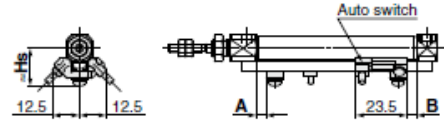

D-A7□/A80
D-A73C/A80C
D-A79W

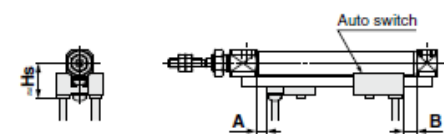

D-A7□H/A80H

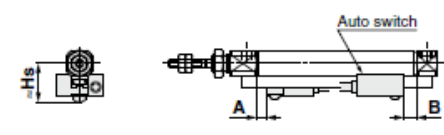

Auto Switch Proper Mounting Position

| Auto switch model | Rail mounting (mm) | | | | | | | | | | | | |
|-------------------|---|-----|-----------------|-----|----------------|-----|---|-----|--------|-----|--------|-----|--|
| | D-M9□ D-M9□V D-M9□W D-M9□WV D-M9□A D-M9□AV | | D-A9□ D-A9□V | | D-A7□ D-A80 | | D-A7□H/A80H D-A73C/A80C D-F7□/J79 D-F7□W/J79W D-F7□V/F7□WV D-F79F D-J79C D-F7BA D-F7BAV | | D-F7NT | | D-A79W | | |
| | A | B | A | B | A | B | A | B | A | B | A | B | |
| Bore size (mm) | | | | | | | | | | | | | |
| 10 | 4.5 | 4.5 | 0.5 | 0.5 | 3 | 3 | 3.5 | 3.5 | 8.5 | 8.5 | 0.5 | 0.5 | |
| 16 | 5 | 5 | 1 | 1 | 3.5 | 3.5 | 4 | 4 | 9 | 9 | 1 | 1 | |

* Adjust the auto switch after confirming the operating condition in the actual setting.

Auto Switch Mounting Height

| Auto switch model | Rail mounting (mm) | | | | | |
|-------------------|--|--|------------------|------------------------------|--------|--------|
| | D-M9□ D-M9□V D-M9□W D-M9□WV D-M9□A D-M9□AV D-A9□ D-A9□V | D-A7□H/A80H D-F7□/J79 D-F7□W/J79W D-F7BA/F79F D-F7NT | D-A73C D-A80C | D-F7□V D-F7□WV D-F7BAV | D-J79C | D-A79W |
| Bore size (mm) | Hs | Hs | Hs | Hs | Hs | Hs |
| 10 | 17.5 | 17.5 | 23.5 | 20 | 23 | 19 |
| 16 | 21 | 20.5 | 26.5 | 23 | 26 | 22 |

Table 4 Minimum Stroke for Auto Switch Mounting

| Auto switch mounting | Auto switch model | Number of auto switches | | | | |
|----------------------|---|-------------------------|--------------------|--------------|---|--|
| | | With 1 pc. | With 2 pos. | | With n pos. (n: Number of auto switches) | |
| | | | Different surfaces | Same surface | Different surfaces | Same surface |
| Band mounting | D-M9□ D-M9□W D-M9□A D-A9□ | 10 | 15 Note 1) | 45 Note 1) | $15 + 35 \frac{(n-2)}{2}$ (n = 2, 4, 6...) | $45 + 15 (n-2)$ (n = 2, 3, 4, 5...) |
| | D-M9□V | 5 | 15 Note 1) | 35 | $15 + 35 \frac{(n-2)}{2}$ (n = 2, 4, 6...) | $35 + 25 (n-2)$ (n = 2, 3, 4, 5...) |
| | D-M9□WV D-M9□AV | 10 | 15 Note 1) | 35 | $15 + 35 \frac{(n-2)}{2}$ (n = 2, 4, 6...) | $35 + 25 (n-2)$ (n = 2, 3, 4, 5...) |
| | D-A9□V | 5 | 10 | 35 | $10 + 35 \frac{(n-2)}{2}$ (n = 2, 4, 6...) | $35 + 25 (n-2)$ (n = 2, 3, 4, 5...) |
| | D-C7□ D-C8□ | 10 | 15 | 50 | $15 + 40 \frac{(n-2)}{2}$ (n = 2, 4, 6...) | $50 + 20 (n-2)$ (n = 2, 3, 4, 5...) |
| | D-H7□/H7□W D-H7BA D-H7NF | 10 | 15 | 60 | $15 + 45 \frac{(n-2)}{2}$ (n = 2, 4, 6...) | $60 + 22.5 (n-2)$ (n = 2, 3, 4, 5...) |
| | D-C73C D-C80C D-H7C | 10 | 15 | 65 | $15 + 50 \frac{(n-2)}{2}$ (n = 2, 4, 6...) | $50 + 27.5 (n-2)$ (n = 2, 3, 4, 5...) |
| Rail mounting | D-M9□V | 5 | — | 5 | — | $10 + 10 (n-2)$ (n = 4, 6...) |
| | D-A9□V | 5 | — | 10 | — | $10 + 15 (n-2)$ (n = 4, 6...) |
| | D-M9□ D-A9□ | 10 | — | 10 | — | $15 + 15 (n-2)$ (n = 4, 6...) |
| | D-M9□WV D-M9□AV | 10 | — | 15 | — | $15 + 15 (n-2)$ (n = 4, 6...) |
| | D-M9□W | 15 | — | 15 | — | $20 + 15 (n-2)$ (n = 4, 6...) |
| | D-M9□A | 15 | — | 20 | — | $20 + 15 (n-2)$ (n = 4, 6...) |
| | D-A7□/A8□ D-A7□V/A8□H D-A73C/A8□C | 5 | — | 10 | — | $15 + 10 (n-2)$ (n = 4, 6...) |
| | D-A7□H D-A8□H | 5 | — | 10 | — | $15 + 15 (n-2)$ (n = 4, 6...) |
| | D-A79W | 10 | — | 15 | — | $10 + 15 (n-2)$ (n = 4, 6...) |
| | D-F7□ D-J79 | 5 | — | 5 | — | $15 + 15 (n-2)$ (n = 4, 6...) |
| | D-F7□V D-J79C | 5 | — | 5 | — | $10 + 10 (n-2)$ (n = 4, 6...) |
| | D-F7□W/J79W D-F7BA/F79F/F7NT | 10 | — | 15 | — | $15 + 20 (n-2)$ (n = 4, 6...) |
| | D-F7□WV D-F7BAV | 10 | — | 15 | — | $10 + 15 (n-2)$ (n = 4, 6...) |

Note 1) Auto switch mounting

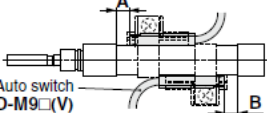
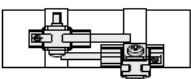
| Auto switch model | With 2 auto switches | |
|---|---|-----------------------------|
| | Different surfaces Note 1) | Same surface Note 1) |
|  <p>Auto switch D-M9□(V) D-M9□W(V) D-M9□A(V)</p> <p>The proper auto switch mounting position is 5.5 mm inward from the switch holder edge. The above A and B indicate values for band mounting in the table of P.10.</p> |  <p>The auto switch is mounted by slightly displacing it in a direction (cylinder tube circumferential exterior) so that the auto switch and lead wire do not interfere with each other.</p> | |
| D-M9□/M9□W/M9□A | Less than 20 stroke Note 2) | Less than 55 stroke Note 2) |
| D-A9□/A93 | — | Less than 50 stroke Note 2) |

Note 2) Minimum stroke for auto switch mounting in styles other than those mentioned in Note 1.

Table 5 Operating Range

| Auto switch model | | Bore size (mm) | |
|-------------------|---|----------------|-----|
| | | 10 | 16 |
| Band mounting | D-M9□/M9□V D-M9□W/M9□WV D-M9□A/M9□AV | 2.5 | 3 |
| | D-A9□ | 6 | 7 |
| | D-C7□/C80/C73C/C80C | 7 | 7 |
| | D-H7□/H7□W D-H7BA/H7NF | 4 | 4 |
| | D-H7C | 8 | 9 |
| Rail mounting | D-M9□/M9□V D-M9□W/M9□WV D-M9□A/M9□AV | 3 | 3.5 |
| | D-A9□/A9□V | 6 | 6.5 |
| | D-A7□/A80/A7H/A80H D-A73C/A80C | 8 | 9 |
| | D-A79W | 11 | 13 |
| | D-F7□/J79/F7□W/J79W D-F7□V/F7□WV/F79F D-J79C/F7BA/F7BAV D-F7NT | 5 | 5 |

* Values which include hysteresis are for guideline purposes only, they are not a guarantee (assuming approximately ±30% dispersion) and may change substantially depending on the ambient environment.

Other than the applicable auto switches listed in "How to Order", the following auto switches are mountable. Refer to pages 1263 to 1371 in Best Pneumatics No. 2 for detailed specifications.

| Type | Mounting | Model | Electrical entry | Features |
|-------------|---------------|-------------------------|-------------------|--|
| Solid state | Band mounting | D-H7A1/H7A2/H7B | Grommet (In-line) | — |
| | | D-H7NW/H7PW/H7BW | | Diagnostic indication (2-color indication) |
| | Rail mounting | D-F79/F7P/J79 | | — |
| | | D-F79W/F7PW/J79W | | Diagnostic indication (2-color indication) |
| | Band mounting | Grommet (Perpendicular) | D-F7NV/F7PV/F7BV | — |
| | | | D-F7NWV/F7BWV | Diagnostic indication (2-color indication) |
| Reed | Band mounting | D-C73/C76 | Grommet (In-line) | — |
| | | D-C80 | | Without light |
| | Rail mounting | D-A73H/A76H | | — |
| | | D-A80H | | Without light |
| | Band mounting | Grommet (Perpendicular) | D-A73 | — |
| | | | D-A80 | Without light |

* With pre-wired connector is also available for solid state auto switches. For details, refer to pages 1328 and 1329 in Best Pneumatics No. 2.
 * Normally closed (NC = b contact) solid state auto switches (D-F9G/F9H) are also available. For details, refer to page 1290 in Best Pneumatics No. 2.

Auto Switch Connection and Example

Sink Input Specifications

3-wire, NPN

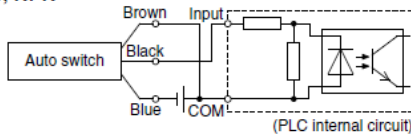

2-wire

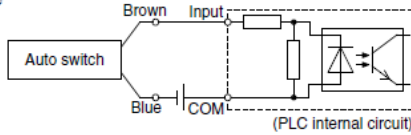

Source Input Specifications

3-wire, PNP

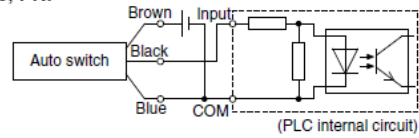

2-wire

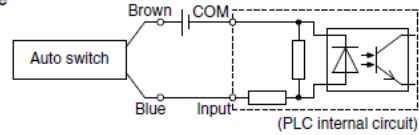

Connect according to the applicable PLC input specifications, as the connection method will vary depending on the PLC input specifications.

Example of AND (Series) and OR (Parallel) Connection

3-wire, AND connection for NPN output (Using relays)

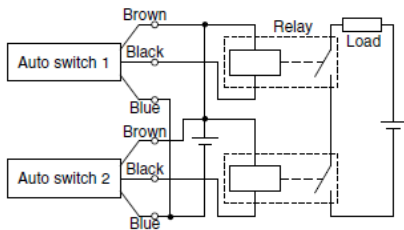

(Performed with auto switches only)

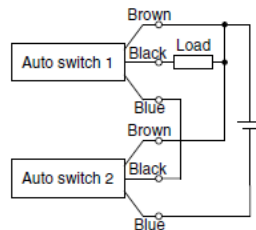

3-wire, OR connection for NPN output

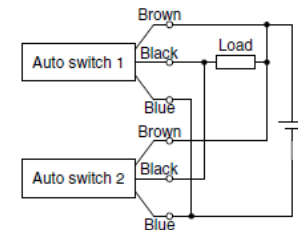

(Performed with auto switches only)

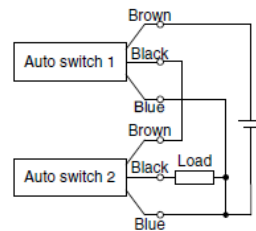

3-wire, AND connection for PNP output (Using relays)

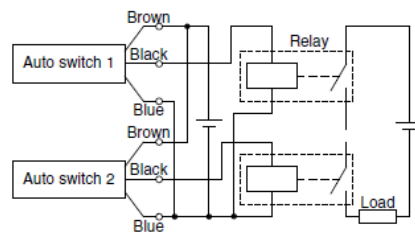

3-wire, OR connection for PNP output

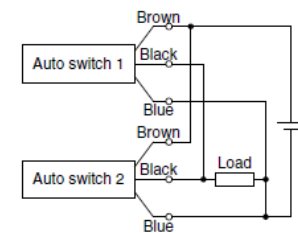

2-wire, AND connection

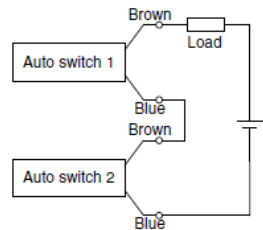

When two auto switches are connected in series, malfunction may occur because the load voltage will decrease in the ON state. The indicator lights will light up when both of the auto switches are in the ON state.

$$\begin{aligned} \text{Load voltage at ON} &= \text{Power supply voltage} - \text{Residual voltage} \times 2 \text{ pcs.} \\ &= 24 \text{ V} - 4 \text{ V} \times 2 \text{ pcs.} \\ &= 16 \text{ V} \end{aligned}$$

Example: Power supply voltage 24 VDC
Auto switch internal voltage drop 4 V

2-wire, OR connection

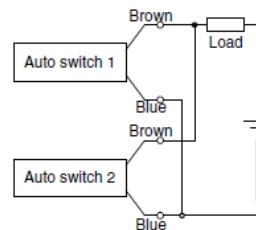

(Solid state)
When two auto switches are connected in parallel, malfunction may occur because the load voltage will increase in the OFF state.

$$\begin{aligned} \text{Load voltage at OFF} &= \text{Leakage current} \times 2 \text{ pcs.} \times \text{Load impedance} \\ &= 1 \text{ mA} \times 2 \text{ pcs.} \times 3 \text{ k}\Omega \\ &= 6 \text{ V} \end{aligned}$$

Example: Load impedance 3 kΩ
Auto switch leakage current 1 mA

(Reed)
Because there is no leakage current, the load voltage will not increase in the OFF state. However, depending on the number of auto switches in the ON state, the indicator lights may sometimes grow dim or not light up, due to the dispersion and reduction of the current flowing to the auto switches.

3. Maintenance



Caution

For the CJ2-*Z series, the cover and cylinder tube are joined by rolling crimping, and cannot be disassembled.

Seals of CJ2-*Z series cannot be replaced.

3-1. Checks

3-1-1 Daily check

- 1) Smoothness of the operation
- 2) Changes in piston speed and cycle time.
- 3) Proper stroking

3-1-2 Regular check

- 1) Tightness of mounting nuts and rod end nuts
- 2) Tightness of mounting frame and any excessive deflection
- 3) Smoothness of the operation
- 4) Changes in piston speed and cycle time.
- 5) External leakage
- 6) Proper stroking
- 7) Damage to the piston rod
- 8) Whether drainage in the air filter is regularly discharged or not.

Check the points above at least, and retighten or contact the sales representative if any failure is found.

3-2. Consumable parts

Use our recommended grease.

Grease pack part number: GR-S-010 (10g), GR-S-020 (20g)



Warning

1) Maintenance should be performed according to the items above.

Improper handling can cause damage and malfunction of equipment and machinery.

2) Removal of equipment, and supply/exhaust of compressed air

When equipment is serviced, first confirm that measures are in place to prevent dropping of driven objects and run-away of equipment, etc. Then cut the supply pressure and power, and exhaust all compressed air from the system using its residual pressure release function.

When machinery is restarted, check that operation is normal with actuators in the proper positions.

4. Basic Circuit for Cylinder Operation

The basic circuit for operating the product with air filter, regulator, solenoid valve and speed controller (meter-out) is shown in the following figure.

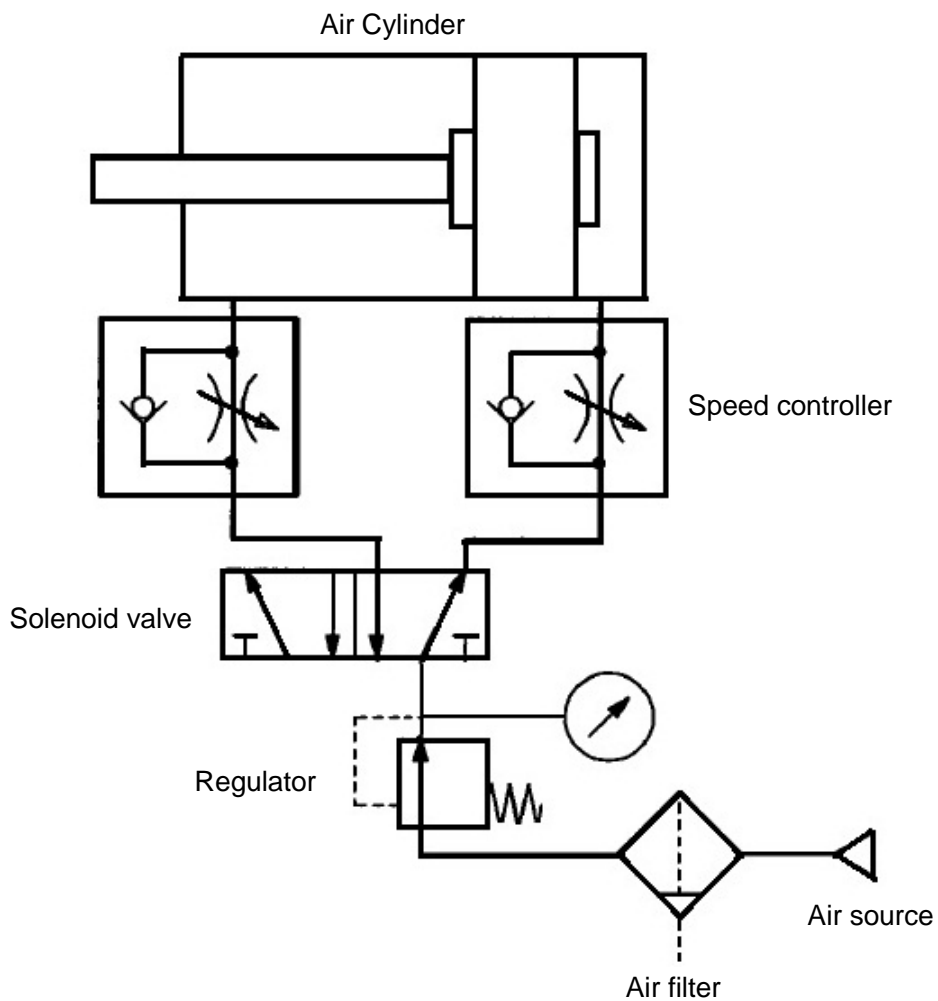

Fig.3 Basic Circuit

5. Troubleshooting

| Trouble | Major causes | Countermeasures |
|--------------------------------|---|--|
| Operation has lost smoothness. | 1. Shortage of grease at the sliding part of the piston rod | - Apply the specified grease. GR-S-010(10g), GR-S-020(20g) |
| | 2. Deformation of piston rod | - Replace the cylinder with a new one. When reinstalling the product, adjust the load and mounting position. |
| | 3. Insufficient pressure | - Supply appropriate pressure. |
| | 4. Operation at a low speed outside of the limit. | - Consult SMC. |
| Force has decreased. | 1. Air leakage from piston seal | - Replace the cylinder with a new one. |
| | 2. Air leakage from rod seal | - Replace the cylinder with a new one. |
| | 3. Decreased pressure | - Secure sufficient pressure and review margin of air supply source. |
| | 4. Insufficient flow rate | - The resistance in the fluid path may have increased due to deformation or foreign matter entering the product. Perform repair or cleaning. |
| | 5. Incorrect mounting position of the product | - Mount in a proper position without any force applied to the product. |
| | 6. Deformation of piston rod | - Replace the cylinder with a new one. When reinstalling the product, adjust the load and mounting position. |
| | 7. Lubrication failure | - Refer to the countermeasure for the trouble "Operation has lost smoothness." |
| Piston speed is too fast. | 1. Lack of speed controller | - Use a speed controller suitable for the size of the product. |
| | 2. Insufficient fine adjustment of speed controller | - Select an adjustable speed controller to obtain the required piston speed referring to the flow-rate characteristics curve. |

| Trouble | Major causes | Countermeasures |
|--|--|---|
| Piston speed is too slow. | 1. Too small directional control valve. | - Use a valve of a larger size. |
| | 2. Too large resistance of equipment used on the way of piping | - Use valves and equipment of an appropriate size. In particular, attention should be paid to the piping and fittings because they are often missed. Equipment and piping at the exhaust side should also be of an appropriate size. |
| The product sometimes does not operate. | 1. Operation at a very low speed | - Operation at a very low speed can create a condition with almost no pressure difference between the supply side and exhaust side and lower sealing effect, which can cause operation failure. Keep the specified speed for operation. |
| | 2. Problem of equipment other than this product | - Check all items in the system one by one to find the cause. |
| The product has become unable to operate. | 1. Damage of piston seal | - Check that the exhaust port of the valve is exhausting all the time. - Replace the cylinder with a new one. |
| | 2. Problem of equipment other than this product | - Check all items in the system one by one to find the cause. |
| | 3. Insufficient pressure | - Supply appropriate pressure. |
| The piston rod has been deformed and broken. | 1. Operation at high speed | - Operation at a high speed can cause impact, and deform and damage the product. Keep within the specified piston speed range. |
| | 2. Excessive external force | - It may cause damage and deformation of the cylinder if the mechanism interferes or eccentric load or over load is applied to it. Remove these factors. |
| Piston speed cannot be adjusted with the speed controller. | 1. Incorrect speed controller selection | - Use a speed controller of a suitable size for the required speed. |
| | 2. Problem with the speed controller. | - Replace the speed controller with a new one. |

| Trouble | Major causes | Countermeasures |
|--|---|---|
| The product has stick-slip movement. | 1. Cylinder speed too slow | - Consult SMC. |
| | 2. Insufficient margin of force | - Increase operating pressure. - Replace with a product of a larger bore size. |
| | 3. Use of a meter-in circuit | - Operation at a low pressure or low speed with a meter-in circuit can cause unstable motion. Use a meter-out circuit for speed adjustment. |
| The product shows sudden and fast movement after being stopped for extended periods of time. | 1. Fluctuation of residual pressure in the product between continuous operation and operation after stoppage for extended periods of time | - Consider the use of a valve to prevent sudden action of the product. |

6. Construction

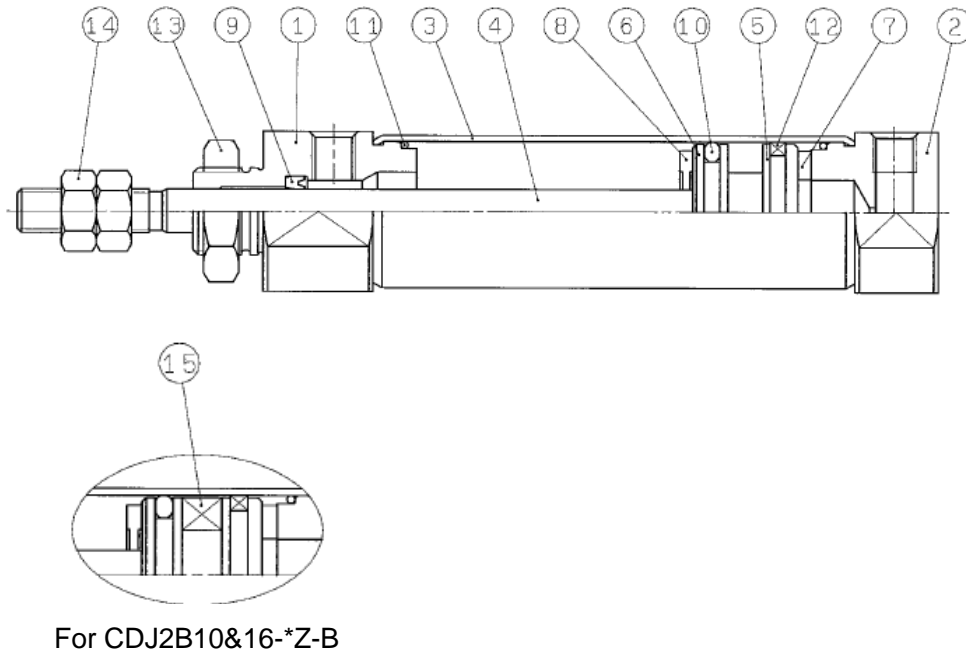
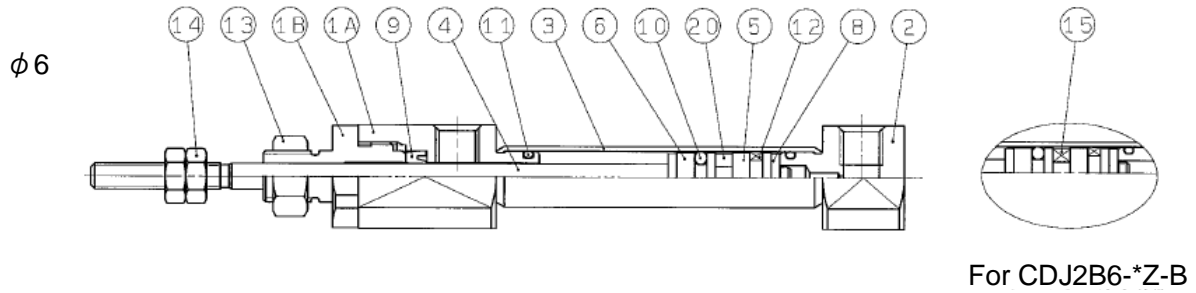

Fig. 4 Standard product: Double acting/single rod

| No. | Description | Note |
|-----|---------------|---------|
| 1A | Rod cover | |
| 1B | Seal retainer | Ø6 only |
| 2 | Head cover A | |
| 3 | Cylinder tube | |
| 4 | Piston rod | |
| 5 | Piston A | |
| 6 | Piston B | |
| 7 | Bumper A | |
| 8 | Bumper B | |
| 9 | Rod seal | |
| 10 | Piston seal | |
| 11 | Tube gasket | |
| 12 | Wear ring | |
| 13 | Mounting nut | |
| 14 | Rod end nut | |
| 15 | Magnet | |

| Revision history |
|------------------|
|------------------|

SMC Corporation

4-14-1, Sotokanda, Chiyoda-ku, Tokyo 101-0021 JAPAN
Tel: + 81 3 5207 8249 Fax: +81 3 5298 5362
URL <http://www.smcworld.com>

Note: Specifications are subject to change without prior notice and any obligation on the part of the manufacturer.
© 2012 SMC Corporation All Rights Reserved