



# Operation Manual

## Installation · Operation

Original Instructions  
Thermo Chiller  
*HRS Series*

*HRS400-A \*-46-\**

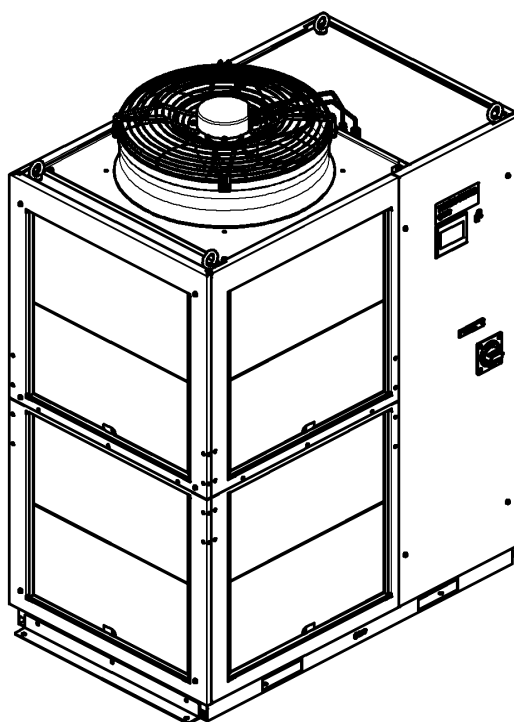

**Keep this manual available whenever necessary**

## To the users

Thank you for purchasing SMC's Thermo chiller (hereinafter referred to as the "product").

For safety and long life of the product, be sure to read this operation manual (hereinafter referred to as the "manual") and clearly understand the contents.

- Be sure to read and follow all instructions noted with "Warning" or "Caution" in this manual.
- This manual is intended to explain the installation and operation of the product. Only people who understand the basic operation of the product through this manual or who perform installation and operation of or have basic knowledge about industrial machines are allowed to work on the product.
- This manual and other documents attached to the product do not constitute a contract, and will not affect any existing agreements or commitments.
- It is strictly prohibited to copy this manual entirely or partially for the use by a third party without prior permission from SMC.

**Note: This manual is subject to possible change without prior notice.**

# Contents

<b>Chapter 1</b>	<b>Safety Instructions .....</b>	<b>1-1</b>
1.1	Before Using the Product .....	1-1
1.2	Reading the Manual .....	1-1
1.3	Hazards .....	1-2
1.3.1	Level of hazards .....	1-2
1.3.2	Definition of “Serious injury” and “Minor injury” .....	1-2
1.4	Product Label .....	1-3
1.5	Safety Measures .....	1-4
1.5.1	Safety instructions for use .....	1-4
1.5.2	Personal protective equipment .....	1-4
1.6	Emergency Measures.....	1-5
1.7	Waste Disposal.....	1-5
1.7.1	Disposal of refrigerant and compressor oil .....	1-5
1.7.2	Disposal of product .....	1-5
1.7.3	Battery .....	1-6
1.8	Safety Data Sheet (SDS) .....	1-6
<b>Chapter 2</b>	<b>Name and Function of Parts .....</b>	<b>2-1</b>
2.1	Model Number of Product.....	2-1
2.2	Name and Function of Parts .....	2-2
2.2.1	HRS400-A*-46-* (Air cooled type).....	2-2
2.3	Function of Parts.....	2-4
<b>Chapter 3</b>	<b>Transport and Setting Up.....</b>	<b>3-1</b>
3.1	Transport.....	3-1
3.1.1	transportation using forklift and hanging .....	3-2
3.1.2	Transportation using casters .....	3-3
3.2	Installation .....	3-4
3.2.1	Environment .....	3-4
3.2.2	Operation at low ambient temperature or low circulating fluid temperature .....	3-5
3.2.3	Location.....	3-6
3.2.4	Installation and maintenance space.....	3-7
3.3	Installation .....	3-8
3.3.1	Installation .....	3-8
3.3.2	Electrical wiring .....	3-10
3.3.3	Preparation and wiring of power supply cable .....	3-12
3.3.4	Contact input/output communication wiring .....	3-17
3.3.5	Wiring of the Run/Stop signal input.....	3-21
3.3.6	Wiring of the contact output signal.....	3-23
3.3.7	Wiring of analog output signal.....	3-24
3.3.8	RS-485 communication wiring .....	3-24
3.3.9	RS-232C communication wiring.....	3-26
3.4	Piping.....	3-28

<b>3.5</b>	<b>Circulating Fluid Supply</b> .....	<b>3-31</b>
3.5.1	Automatic fluid fill function.....	3-31
3.5.2	Fluid supply without using the automatic fluid fill function.....	3-33
3.5.3	Option K “Fluid fill port”.....	3-35
<b>Chapter 4</b>	<b>Starting the Product</b> .....	<b>4-1</b>
<b>4.1</b>	<b>Before Starting</b> .....	<b>4-1</b>
<b>4.2</b>	<b>Preparation for Start</b> .....	<b>4-2</b>
4.2.1	Power supply.....	4-2
4.2.2	Operation screen (home screen).....	4-3
<b>4.3</b>	<b>Preparation of the Circulating Fluid Supply to the User's Equipment</b> .....	<b>4-5</b>
<b>4.4</b>	<b>Operation Start and Stop</b> .....	<b>4-7</b>
4.4.1	Setting of circulating fluid temperature.....	4-7
4.4.2	Setting of the pump operation mode.....	4-8
4.4.3	Starting the Product.....	4-8
4.4.4	Stopping the product.....	4-9
<b>4.5</b>	<b>Check Items during Startup</b> .....	<b>4-10</b>
<b>4.6</b>	<b>Adjusting the Circulating Fluid Flow Rate</b> .....	<b>4-10</b>
<b>Chapter 5</b>	<b>Display and Setting of Various Functions</b> .....	<b>5-1</b>
<b>5.1</b>	<b>Basic Operation</b> .....	<b>5-1</b>
5.1.1	Touch panel.....	5-1
5.1.2	Basic operating instructions.....	5-2
<b>5.2</b>	<b>Flow Chart of the Operation Screen</b> .....	<b>5-4</b>
5.2.1	Flow Chart of the Operation Screen.....	5-4
<b>5.3</b>	<b>List of Functions</b> .....	<b>5-7</b>
<b>5.4</b>	<b>Description of the Screen</b> .....	<b>5-8</b>
5.4.1	Home screen.....	5-8
	•Menu key.....	5-10
	•Display and setting of date and time.....	5-10
	•Current circulating fluid temperature [PV]Circulating fluid set temperature [SP].....	5-10
	•Operating condition display.....	5-11
	•Pump operating condition display.....	5-11
	•Tank fluid level.....	5-12
	•Circulating fluid flow rate Circulating fluid flow rate.....	5-12
	•Circulating fluid discharge pressure Press PV.....	5-12
	•Compressor circuit High pressure side High Press.....	5-12
	•Compressor circuit Low pressure side Low Press.....	5-13
	•Circulating fluid electrical conductivity DI PV.....	5-13
	•Key lock condition display KEYLOCK.....	5-13
	•Startup operation status display START UP.....	5-14
	•Anti-freezing status display ANTI-FREEZE.....	5-14
	•Warming up status display WARMING UP.....	5-14
	•Pump operation continuation status display PUMP KEEP RUN.....	5-15
	•Circulating fluid set temperature SP.....	5-15



---

• Operation mode MODE .....	5-16
• Independent pump operation Pump .....	5-16
• Run/stop operation .....	5-17
5.4.2 Menu .....	5-18
5.4.3 Status screen .....	5-18
5.4.4 Information screen .....	5-19
• Alarm reset.....	5-21
• Alarm name.....	5-21
• Alarm log record.....	5-22
• Display of alarm/maintenance reminder .....	5-23
5.4.5 Check operation time screen and maintenance reminder .....	5-24
• Setting the usage time of DI filter.....	5-26
• Setting of the usage time of dustproof filter .....	5-26
5.4.6 Software version screen.....	5-27
5.4.7 Setting screen .....	5-27
• Temperature rise/drop alarm (AL10/AL11).....	5-28
• TEMP READY alarm (AL12) of TEMP READY function.....	5-30
• Offset (TEMP OFFSET) function .....	5-33
• Pump operation mode .....	5-36
• Discharge pressure alarm (AL18/AL19/AL20).....	5-37
• Electric conductivity and alarm setting (AL28).....	5-39
5.4.8 Function setting screen .....	5-41
• KEY-LOCK, START-UP operating method, ANTI-FREEZING and WARMING-UP .....	5-42
• Continuing pump operation.....	5-43
• Ambient temperature alarm (AL35) and maintenance alarm (AL36).....	5-46
• TEMP OUT signal .....	5-47
• Data reset .....	5-48
5.4.9 Communication setting screen.....	5-49
• Setting for communication error (AL34)/contact input signal detection (AL30 and AL31).....	5-50
• Serial communication setting.....	5-51
• Setting of analog output signal .....	5-53
• Setting of contact input signal form.....	5-54
• Setting of contact output signal 1 to 3 .....	5-55
• Setting of contact output signal 4 to 6 .....	5-55
5.4.10 Temperature waveform screen.....	5-59
<b>Chapter 6 Alarm Notifications and Troubleshooting .....</b>	<b>6-1</b>
<b>6.1 Alarm Notification .....</b>	<b>6-1</b>
<b>6.2 Operation of this product when an alarm occurs .....</b>	<b>6-1</b>
<b>6.3 Troubleshooting .....</b>	<b>6-2</b>
6.3.1 Alarm contents, causes, and troubleshooting.....	6-2
<b>6.4 Other Errors.....</b>	<b>6-5</b>
<b>Chapter 7 Control, Inspection and Cleaning .....</b>	<b>7-1</b>

---

---

<b>7.1</b>	<b>Quality Control of Circulating Fluid and Facility Water .....</b>	<b>7-1</b>
<b>7.2</b>	<b>Inspection and Cleaning.....</b>	<b>7-2</b>
7.2.1	Daily check .....	7-3
7.2.2	Monthly check.....	7-3
7.2.3	Inspection every 3 months.....	7-5
7.2.4	Inspection during winter season .....	7-6
<b>7.3</b>	<b>Operation Stop for an Extended Period of Time .....</b>	<b>7-7</b>
7.3.1	Discharge of the circulating fluid .....	7-7
<b>7.4</b>	<b>Replacement of consumables.....</b>	<b>7-9</b>
7.4.1	Replacing the DI Filter 【For Option D】 .....	7-9
7.4.2	Consumables.....	7-11
<b>Chapter 8</b>	<b>Documents .....</b>	<b>8-1</b>
<b>8.1</b>	<b>Specifications .....</b>	<b>8-1</b>
8.1.1	HRS400-A*-46-* .....	8-1
8.1.2	Refrigerant with GWP reference.....	8-2
8.1.3	Communication specifications .....	8-2
<b>8.2</b>	<b>Dimensions .....</b>	<b>8-3</b>
<b>8.3</b>	<b>Flow Diagram .....</b>	<b>8-4</b>
<b>8.4</b>	<b>Cooling Capacity.....</b>	<b>8-5</b>
<b>8.5</b>	<b>Pump Capacity.....</b>	<b>8-5</b>
<b>8.6</b>	<b>Types of Hazard Labels .....</b>	<b>8-6</b>
8.6.1	Positions of danger warning label .....	8-7
<b>8.7</b>	<b>Standards .....</b>	<b>8-8</b>
<b>8.8</b>	<b>Daily Check Sheet.....</b>	<b>8-9</b>
<b>Chapter 9</b>	<b>Product Warranty .....</b>	<b>9-1</b>

# Chapter 1 Safety Instructions



**Before using the product, be sure to read and understand all the important actions highlighted in this manual.**

## 1.1 Before Using the Product

- This chapter is intended to specifically describe the safety related issues for handling the product. Read this before handling the product.
- The product is a cooling device using circulating fluid. SMC does not take any responsibility for any problems that may arise from using the product for other purposes.
- This product is not designed for a clean room. It generates dust from the internal components such as pump and fan motor.
- The product is operated at high voltage and contains components which become hot and rotate. If a component needs to be replaced or repaired, contact a specialized vendor for parts and service.
- All personnel who work with or around the product should read and understand the safety related information in this manual carefully before starting work.
- The safety manager is responsible for strictly observing safety standards, but responsibility in respect to safety standards during daily work resides with each individual operator and maintenance personnel.
- Do not use the materials that rust or corrode for the circulating fluid and facility water circuits. Using the materials that tend to rust or corrode may cause clogs or/and leakages of the circulating fluid and facility water circuits. In case of using these kind of materials, consider and carry out some prevention against the rusting or corrosion on the customer side.
- This manual must be kept available to operators whenever necessary.

## 1.2 Reading the Manual

This manual contains symbols to help identify important actions when installing, operating or maintaining the product.



**This sign indicates actions that must be followed.**



**This sign indicates prohibited actions.**

## 1.3 Hazards

### 1.3.1 Level of hazards

The instructions given in this manual aim to assure the safe and correct operation of the product, and to prevent injury of operators or damage to the product. These instructions are grouped into three categories, Danger, Warning and Caution, which indicate the level of hazard, damage and also the degree of emergency. All safety critical information should be carefully observed at all times.

“DANGER”, “WARNING” and “CAUTION” signs are in order according to severity (DANGER> WARNING> CAUTION).

#### **DANGER**

“DANGER”: Hazard that **WILL** cause serious personal injury or death during operation.

#### **WARNING**

“WARNING”: Hazard that **MAY** cause serious personal injury or death during operation.

#### **CAUTION**

“CAUTION”: Hazard that **MAY** cause minor personal injury.

#### **CAUTION**

“CAUTION without exclamation symbol”: Hazard that **MAY** cause damage or failure of the product, facility, devices, etc.

### 1.3.2 Definition of “Serious injury” and “Minor injury”

#### ■ “Serious injury”

This term describes injuries that result in after effects including loss of eyesight, burns, electric shock, fracture, poisoning, etc. and requires long-term treatment or hospitalization.

#### ■ “Minor injury”

This term describes injuries that do not need long-term treatment or hospitalization. (Others excluded from “Serious injury”.)

## 1.4 Product Label

Information about the product, such as Serial No. and Model No. can be found on the product label. This information is needed when contacting an SMC sales distributor.

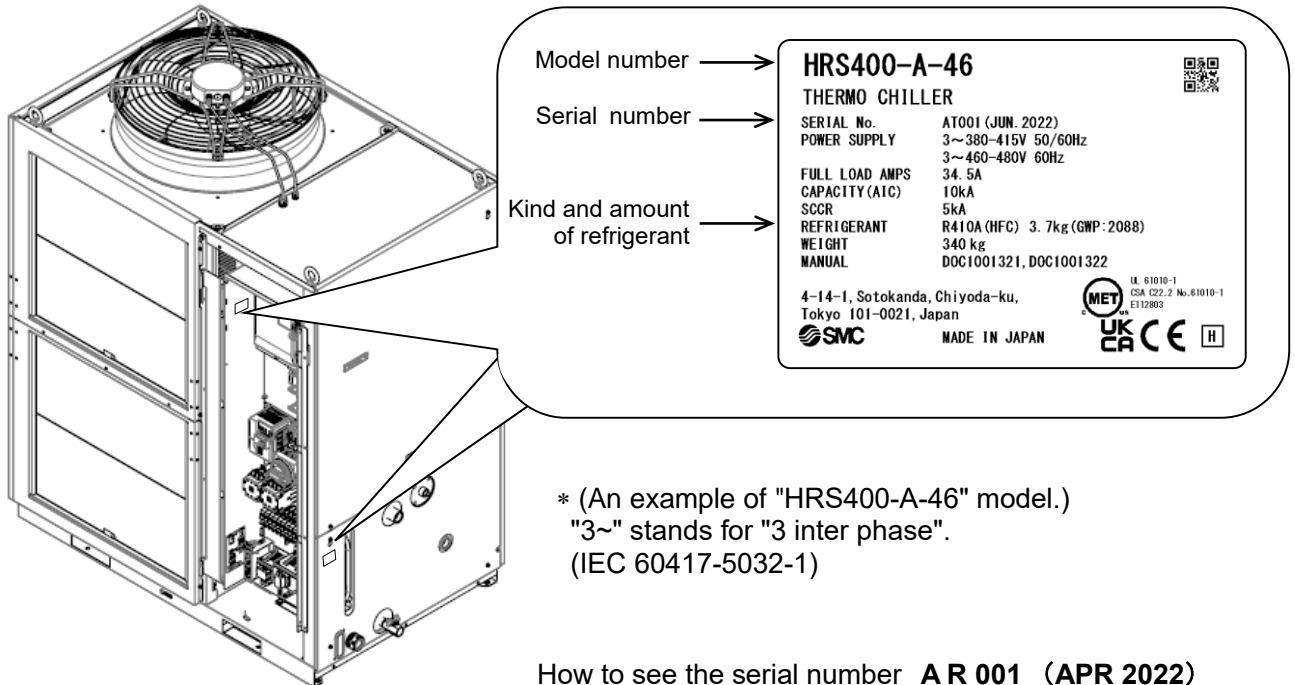

Z			R			001
Year	Symbol	Remarks	Month	Symbol	Remarks	Serial no.
2022	A	Repeated from A to Z in alphabetical order	1	o	Repeated from O to Z in alphabetical order, with O for January and Z for December	—
2023	B		2	P		
2024	C		3	Q		
↓	↓		↓	↓		

Fig. 1-1 Position of the product label

## 1.5 Safety Measures

### 1.5.1 Safety instructions for use

<b>⚠ WARNING</b>	
	<b>Follow the instructions below when using the product. Failure to follow the instructions may cause an accident and injury.</b>

- Read and understand this manual carefully before using the product.
- Before starting maintenance of the product, be sure to lock out and tag out the breaker of the user's power supply.
- If operating the product during maintenance, be sure to inform all workers nearby.
- Use only the correct tools and procedure when installing or maintaining the product.
- Use personal protective equipment where specified ("1.5.2 Personal protective equipment").
- Check all parts and screws are fitted correctly and securely after maintenance.
- Avoid working in a drunken or sick condition, which might cause an accident.
- Do not remove the panels except for the cases permitted in this manual.
- Do not remove the panels during operation.
- Do not handle this product by any means other than specified in this Operation Manual; this can result in damage to the product or fire.

### 1.5.2 Personal protective equipment

This manual specifies personal protective equipment for each work.

#### ■ Transport, Installing and Uninstalling

<b>⚠ CAUTION</b>	
	<b>Always use safety shoes, gloves and head protection when transporting, installing or uninstalling the product.</b>

#### ■ Handling of circulating fluid

<b>⚠ CAUTION</b>	
	<b>Always use safety shoes, gloves, mask, apron and eye protection when handling the circulating fluid.</b>

#### ■ Operation

<b>⚠ CAUTION</b>	
	<b>Always use safety shoes and gloves when operating the product.</b>

## 1.6 Emergency Measures

Emergency Measures When emergency conditions such as natural disaster, fire, earthquake and injury occur, shut off the breaker of the user's power supply that supplies power to the product.

### **WARNING**



Even when the power supply switch is turned off, some of the internal circuits are still energized, unless the user's power supply is shut off. Be sure to shut off the breaker of the user's power supply.

## 1.7 Waste Disposal

### 1.7.1 Disposal of refrigerant and compressor oil

The product uses hydro fluorocarbon type refrigerant (HFC) and compressor oil. Comply with the laws and regulations in each country for the disposal of refrigerant and compressor oil. The type and quantity of refrigerant is described on the "1.4 Product Label".

If these fluids need to be recovered, read and understand the instructions below carefully. If there is any unclear point, contact an SMC's sales distributor.

### **WARNING**



- Only maintenance personnel or qualified people are allowed to open the cover panels of the product.
- Do not mix the compressor oil with domestic waste for disposal. Also, the disposal of the waste must only be conducted by specific facilities that are permitted for that purpose.

### **WARNING**



- Comply with the laws and regulations in each country for the disposal of refrigerant and compressor oil.
- The release of refrigerant in to the atmosphere is banned by law. Recover it with specific equipment and dispose of it correctly.
- Only people who have sufficient knowledge and experience about the product and its accessories are allowed to recover the refrigerant and compressor oil.

### 1.7.2 Disposal of product

The disposal of the product must be handled by a specialized industrial waste disposal agency in accordance with local laws and regulations.

### 1.7.3 Battery

A battery is used in the touch panel of this product. Please inform this to the disposal agency when you dispose this product.

Battery type: GT11-50BAT

System: Manganese Dioxide-Li/Organic Electrolyte

Nominal Voltage: 3V

Nominal Capacity: 550 mAh

Nominal Discharge Current: 0.2 mA

Weight: 6.8 g

Dimension: 24.5 mm × 5.0mm

The lifetime of it is approximately about 5 years, and the touch panel makes "MT07/ Low Battery" Maintenance notice when the battery needs to be replaced.

## 1.8 Safety Data Sheet (SDS)

If the safety data sheets of chemicals used in this product are needed, contact an SMC's sales distributor.

Any chemicals used by the user must be accompanied by an SDS.



# Chapter 2 Name and Function of Parts

## 2.1 Model Number of Product

The product can be ordered with the model number configured as shown below.  
The product needs to be handled in different ways, depending on the part number. Refer to "1.4 Product Label" and check the part number of the product.

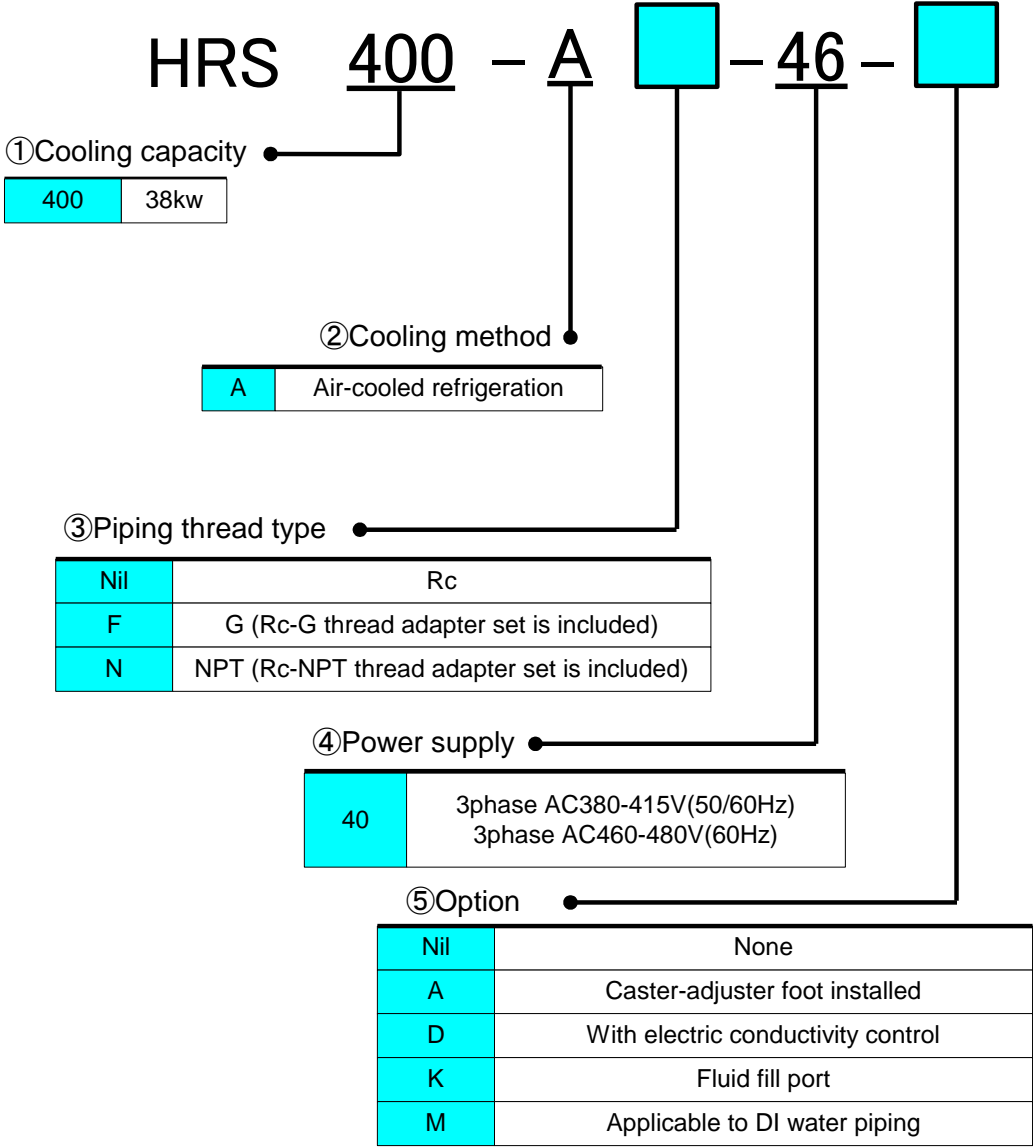

Fig. 2-1 Product model number

## 2.2 Name and Function of Parts

### 2.2.1 HRS400-A\*-46-\* (Air cooled type)

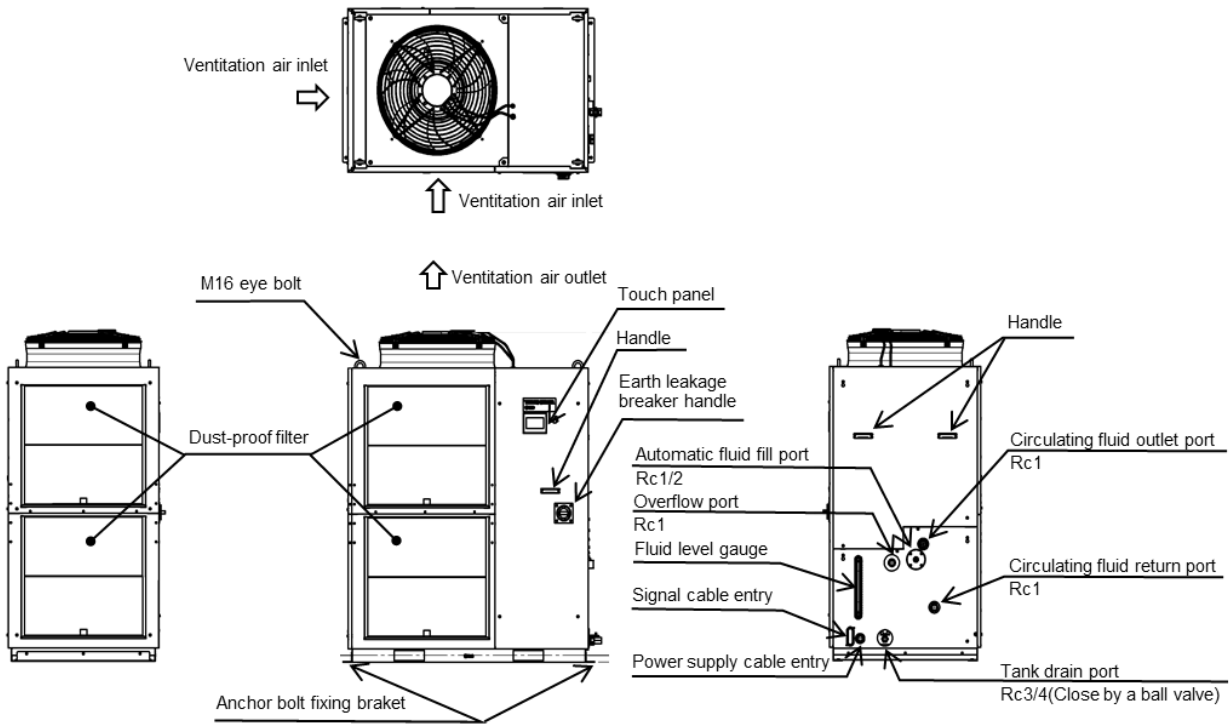







Fig. 2-2 Names of the parts (This drawing shows "HRS400-A-46".)

Table 2.2-1 Accessory list

(1)	Operation Manual	2 pcs. (English 1 pc. /Japanese 1 pc.)	
(2)	Y strainer (40 mesh) 25A	1 pc.	
(3)	Barrel nipple 25A	1 pc.	
(4)	For HRS400-AF-46-* G thread adapter set	1 set	
	For HRS400-AN-46-* NPT thread adapter set	1 set	
(5)	Anchor brackets *1	2 pcs.	—
	(M8 bolts)	(6 pcs).	
(6)	For option D. DI Filter	1 pc.	

\*1 The anchor brackets are used for fixation with the skid when this product is packed. The anchor bolts are not attached. The bolts (M8) used for fixing to the skid are not anchor bolts. Refer to "3.3.1 Installation" when using anchor bolt fixing bracket.

## 2.3 Function of Parts

The function of parts is as follows.

Table 2.3-1 Function of parts

Name	Function
Touch panel	Operational settings for the product. Example: Run and stop product. Performance setting
Fluid level gauge	Indicates the circulating fluid level of the tank. Confirm the level is between HIGH and LOW. For details, refer to "3.5 Circulating Fluid Supply".
Product label	Shows the product information, such as model number and serial number. For details, refer to "1.4 Product Label".
Circulating fluid outlet port	The circulating fluid flows out from the outlet port.
Circulating fluid return port	The circulating fluid returns to the return port.
Tank drain port	This drain port to drain the circulating fluid out of the tank.
Automatic fluid fill port	Piping to the automatic fluid filling port enables easy supply of the circulating fluid through the ball tap in the reservoir. The supply pressure should be within the range of 0.2 to 0.5 MPa.
Overflow port	Be sure to connect piping from this port to sump pit to discharge the excess circulating fluid that is caused by fluid level rising.
Dust-proof filter	Inserted to prevent dust and contamination clinging to the air cooled condensers directly. Clean the filter periodically. For details, refer to "7.2.2 Monthly check".
Power cable entry	Insert the power cable to the power cable entry and connect it to the power terminal. For details, refer to "3.3.2 Electrical wiring" and "3.3.3 Preparation and wiring of power supply cable".
Power terminal	
Signal cable entry	Insert the signal cable to the signal cable entry and connect it to the signal connectors. For details, refer to "3.3.5 Wiring of the Run/Stop signal input", "3.3.6 Wiring of the contact output signal", "3.3.7 Wiring of analog output signal", "3.3.8 RS-485 communication wiring", "3.3.9 RS-232C communication wiring" or the Operation Manual Communication Function.
Signal connectors	
Earth leakage breaker / Breaker handle	Shuts off the power supply to the internal equipment of the product. (Parts energized remained in the product.) Refer to "3.3.2 Electrical wiring" for the earth leakage breaker.
Fluid fill port (When option K "Fluid fill port" is selected.)	Users who will not use the automatic fluid fill function can fill the circulating fluid without removing the panel.

## Chapter 3 Transport and Setting Up

### **WARNING**



- Only persons who have sufficient knowledge and experience about the product and system are allowed to transport and set up the product.
- Especially pay attention to personal safety.

### 3.1 Transport

The product is heavy and is potentially dangerous during transportation. Also, to prevent product damage and breakage, be sure to follow the transportation instructions shown below.

### **WARNING**



- When moving the product by a forklift, insert the fork into the right positions referring to 3.1.1 transportation using forklift and hanging. Moving by forklift and slinging should be done by persons who have the correct license.

### **WARNING**



- Be sure to use all four eye bolts when slinging the product.
- The slant angle of each rope should be 60 degrees or less.

### **CAUTION**



Never lay the product on its side.  
The compressor oil will leak in to the refrigerant piping, which may cause early failure of the compressor.

### **CAUTION**



- Drain the residual fluid from the piping as much as possible to prevent any spillage.

### **CAUTION**



- When the product is carried using a forklift, make sure that the fork does not damage the cover panel or piping port.

### 3.1.1 transportation using forklift and hanging

**⚠ WARNING**



**This is a heavy product. (Refer to Table 3.1-1 Weight of the product)**  
**Moving by forklift and slinging should be done by persons who have the licenses.**

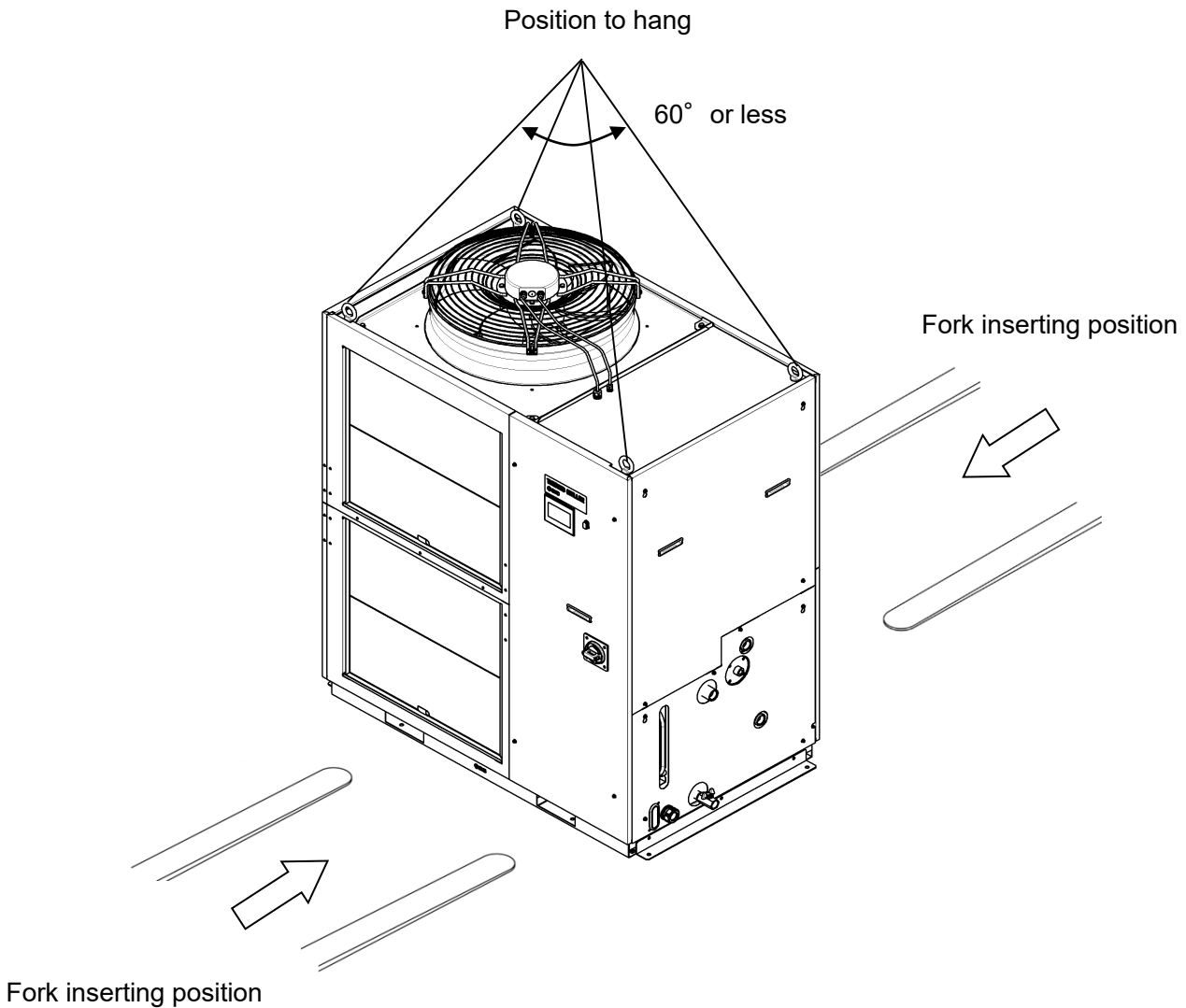

Fig. 3-1 Fork inserting and hanging position (This drawing shows “HRS400-A-46”).

Table 3.1-1 Weight of the product

Model	Weight kg	Option increase
HRS400-A-46	Approx.340	Option A: +14kg Option D: +1kg Option K: +1kg Option M: +0kg

### 3.1.2 Transportation using casters

In case of purchasing option A or the optional accessories, "Caster Adjuster-foot kit" (HRS-KS004) separately and after fastening it to the product.

#### **WARNING**



This is a heavy product. (Refer to Table 3.1-1 "Weight of the product"). Moving the product by casters should be done by 2 persons or more.

#### **CAUTION**



Raise the adjuster feet and push the corners of the product when moving the product using the casters. Do not hold the piping connections or handles of the panels when moving by casters, or it may cause damage to the product..

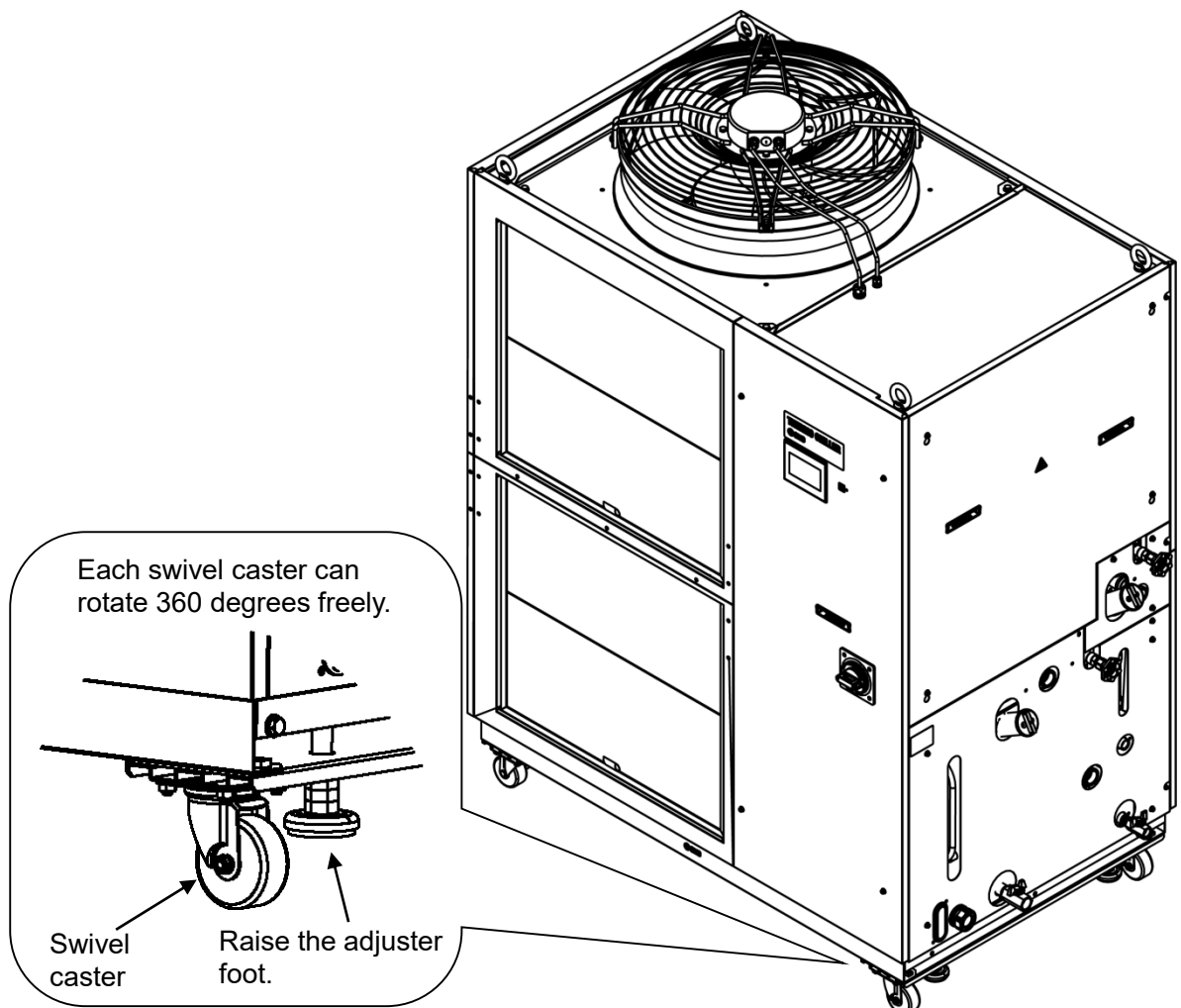

Fig. 3-2 Transportation using casters

## 3.2 Installation

### **WARNING**



- Do not set up the product in exposed locations where there is a risk of flammable gas. Should any flammable gas remain around the product, the product may cause a fire.

### **CAUTION**



- Keep the product upright on a rigid and flat floor which can resist the weight of the product. Take measures to prevent the product from tipping over. Improper installation may cause water leakage, tipping, damage of the product or injure the operator.
- Keep the ambient temperature of the product between -5 to 45°C. Operation out of this ambient temperature range may cause a product malfunction. Operating the product in an environment temperature of 45 °C may reduce the heat discharging efficiency of the heat exchanger and the safety device may function, resulting in the stoppage of the product operation.
- Following the installation, The installer/end user is responsible for performing an acoustic noise risk assessment on the equipment and taking appropriate measures as required.

### 3.2.1 Environment

The product must not be operated, installed, stored or transported in the following conditions. Potential malfunction or damage to the product may occur if these instructions are disregarded.

This product is not designed for clean room usage. The pump and ventilating fan inside the product generate particles.

- Location that is exposed to steam, salt water or oil.
- Location that is exposed to dust or powder material.
- Location that is exposed to corrosive gas, organic solvent, chemical solution, or flammable gas. (The product is not explosion-proof.)
- Location where the ambient temperature is out of the following range:  
During transportation or storage: -15 to 50°C (No water or circulating fluid in the piping.)  
During operation : -5 to 45°C  
\* When the ambient temperature or circulating fluid temperature is 10°C or below, use the circulating fluid specified in "3.2.2 Operation at low ambient temperature or low circulating fluid temperature".
- Location where condensation forms on the inside electrical parts.
- Location that is exposed to direct sunlight or heat radiation.
- Location that is near heat sources and poor in ventilation.
- Location that is subjected to abrupt changes in temperature.
- Location that is subjected to strong electromagnetic noise (intense electric field, intense magnetic field, or surges).
- Location that is subjected to static electricity, or conditions where static electricity can discharge to the product.
- Location that is subjected to strong high frequencies radiation.
- Location that is subjected to potential lightning strike.
- Location at altitude of 3000m or higher (except during product storage and transport). Refer to below for details.
- Location where the product is affected by strong vibrations or impacts.
- Condition that applies external force or weight causing the product to be damaged.



- Location without adequate space for maintenance as required.
- Location that is exposed to splash of water that is higher than IPX4.
- For the product installation or operation in accordance with UL standards, see below.

**■ Thermo-chiller installation at high altitude of 1000 meters or more**

Due to the lower air density, the heat radiation efficiencies of the devices in the product will be lower at an altitude of 1000m or higher. For this reason, the maximum ambient temperature for the thermo-chiller operation and the cooling capacity will be reduced.

For product installation at a place of high altitude of 1000 meters or more, select a thermo-chiller of the applicable capacity referring to the table below.

1. Max. ambient temp.: Use the product in lower ambient temperature than the described value at each altitude.
2. Cooling capacity correction coefficient: Coefficient to calculate the cooling capacity at each altitude  
For the product operation at an altitude of 1800 meters, the cooling capacity = “8.4 Cooling Capacity” x 0.8.

Altitude [m]	1. Max. ambient temp. [°C]	2. Cooling capacity correction coefficient
Less than 1000m	45	1.00
1000m or more - Less than 1500m	42	0.85
1500m or more - Less than 2000m	38	0.80
2000m or more - Less than 2500m	35	0.75
2500m or more - Less than 3000m	32	0.70

**■ Installation/Operation in accordance with the UL standard**

The product cannot be used in the environment shown below:

- Environment at an altitude of 2000 meters or more
- Environment at a pollution degree of 3 or more

**3.2.2 Operation at low ambient temperature or low circulating fluid temperature**

(1) Circulating fluid

In order to avoid freezing of the circulating fluid, use aqueous solution of ethylene glycol.

Ambient temperature (°C)	Recommended circulating fluids
10 to 45	Tap water, ethylene glycol aqueous solution 15(wt.)%
-5 to 10	Ethylene glycol aqueous solution 15(wt.)%

Circulating fluid temperature(°C)	Recommended circulating fluids
10 to 35	Tap water, ethylene glycol aqueous solution 15(wt.)%
5 to 10	Ethylene glycol aqueous solution 15(wt.)%

(2) And following instructions must be executed. If following instructions are not executed, not only Thermo-chiller alarm will be generated, but also damage of the product can result.

- Power has to be supplied to the Thermo-chiller all the time.
- Turn on anti-freezing function (set parameter: SE.10) all the time.  
\*Refer to “KEY-LOCK, START-UP operating method, ANTI-FREEZING and WARMING-UP”(P.5-42) for the setting.
- When the power supply to the Thermo-chiller is stopped for a long period of time, discharge all the circulating fluid in the Thermo-chiller and customer's device and piping. When the Thermo-chiller is refilled with the circulating fluid, supply the fluid at normal temperature.

### 3.2.3 Location

<b>CAUTION</b>	
	<ul style="list-style-type: none"> <li>Do not install in a location which can be subjected to any of the conditions in “3.2.1 Environment”.</li> </ul>

<b>CAUTION</b>	
	<p>Radiates heat from the air vent of the cooling fan. If the product is operated with insufficient air ventilation, the internal temperature can exceed 45°C, which can cause and affect the performance and life of the product. To prevent this, ensure that suitable ventilation is available (see below).</p>

■ **Installation of multiple products**

Keep sufficient space between products so that the air vented from one product will not be taken in by other products.

■ **Installation at indoor site**

- For a facility with a large installation area that can vent the air naturally:
  - Make an air outlet on a wall at a high level and air inlet on a wall at a low level, to allow for adequate airflow.
- For a facility with a small installation area that cannot vent the air naturally:
  - Make a forced air exhaust vent on a wall at a high level and an air inlet on a wall at a low level.
- Using duct to exhaust the air:
  - In case the indoor site cannot accept the exhausted air from the product or/and is air conditioned, ventilate by installing a duct on the outlet ventilation of the product. Do not fasten the duct on the outlet ventilation of the product directly. Ensure the space is at least the duct’s diameter apart. Use a fan for the duct that considers the ventilation resistance of the duct.

Table 3.2-1 Amount of radiation and required ventilation

Model	Heat radiation (kW)	Required ventilation amount (m <sup>3</sup> /min)	
		Differential temp. of 3 °C between inside and outside of installation area	Differential temp. of 6 °C between inside and outside of installation area
HRS400-A*-46-*	Approx.52	865	435

■ **Installation environment specifications**

Sound noise: HRS400-A\*-46\* : 71 dB(A)  
 \* Front 1m, height 1m, rated condition

### 3.2.4 Installation and maintenance space

It is recommended to keep the space around the product shown in Fig. 3-3

**⚠ CAUTION**

 **Have enough space for product ventilation. Otherwise, it may cause a lack of cooling capacity or/and stoppage of the product. Ensure there is enough space for maintenance.**

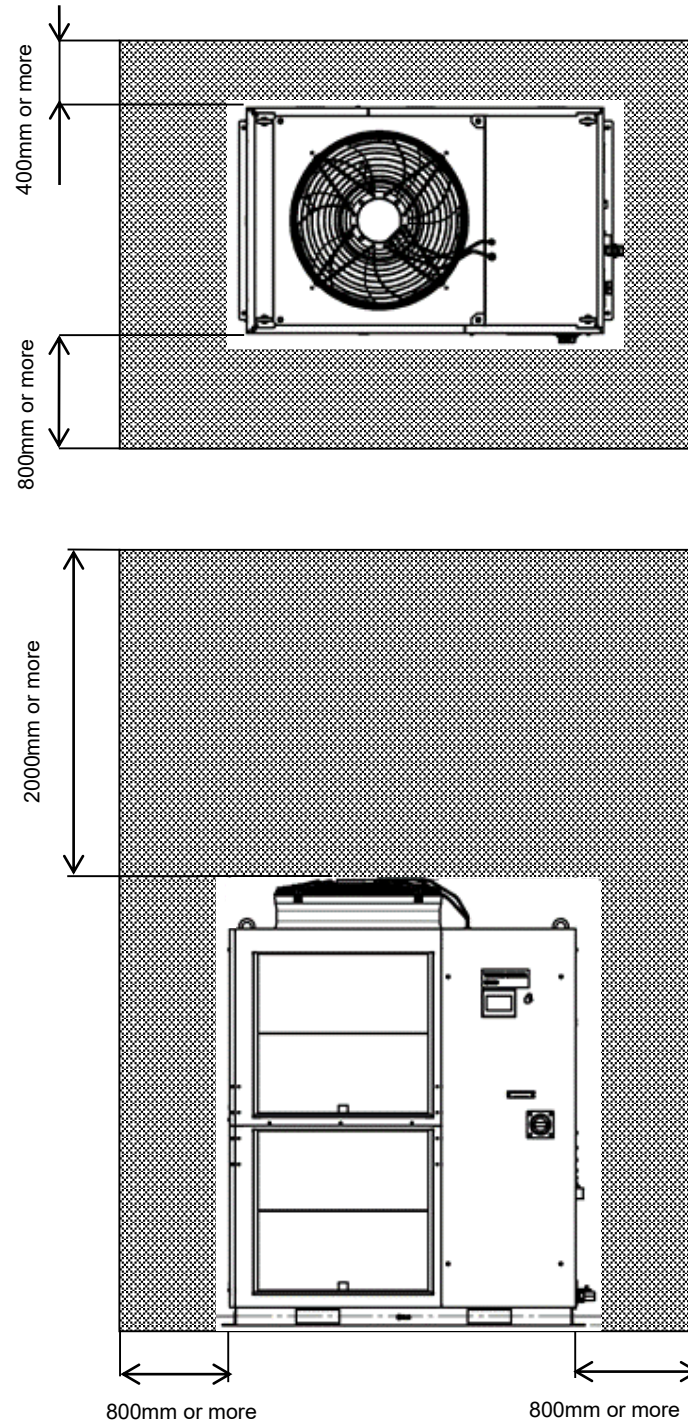

Fig. 3-3 Installation space (This drawing shows "HRS400-A-46")

## 3.3 Installation

### 3.3.1 Installation

#### **⚠ CAUTION**



Install the product on a vibration free level floor.  
Prepare the M10 anchor bolts suitable for the material of the floor that the product will be installed on. Drive the anchor bolts in at least two places on the product's left and right sides (four places in total). Refer to "8.2 Dimensions" for the position dimensions of the anchor bolts.

#### ■ Use a bracket

1. Install this product according to the anchor bolts installed on the level floor.
2. Fasten the nuts to the anchor bolts.
3. Make sure that there is no looseness on any of the anchor bolts and nuts.

#### **[Tips]**

SMC Foundations bolt set "IDF-AB500" (SUS M10x50) is applicable. Please order separately.

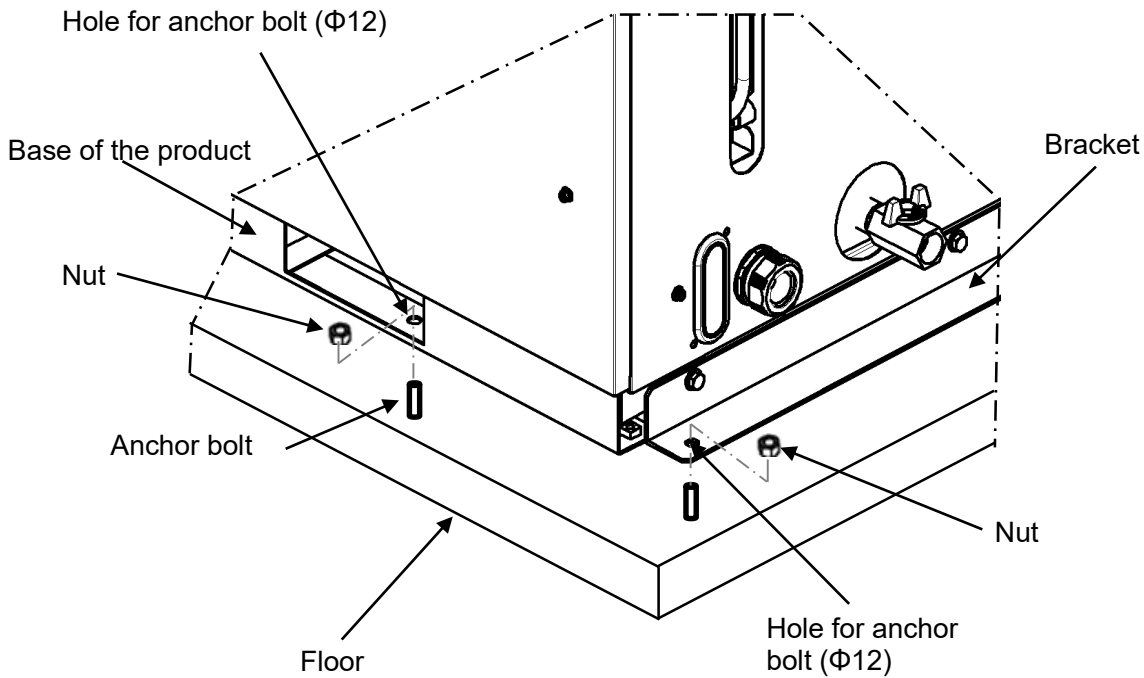

Fig. 3-4 Installation procedures

■ Option A or “Caster Adjuster-foot kit” (HRS-KS004)

**⚠ CAUTION**



Install the product on a vibration free level floor.  
Be sure to use the adjuster foot to install on the floor. The adjuster foot is not earthquake-proof. If necessary make an earthquake-resistant measure on the customer side.

1. Install the product on a level floor.
2. Lower the adjuster to the level floor to fix the product in place.

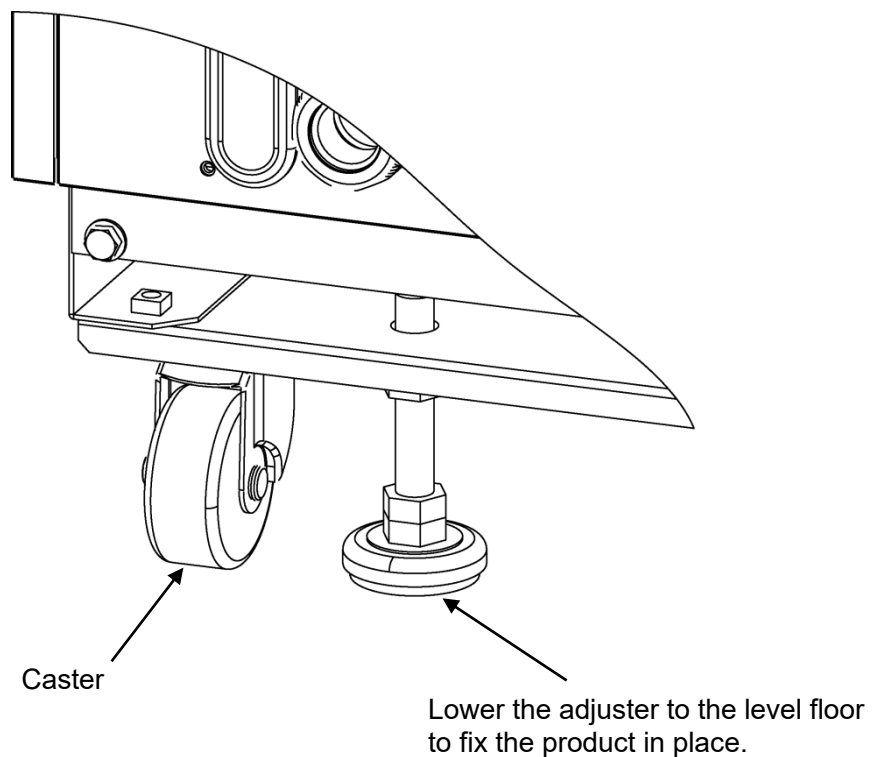

Fig. 3-5 Installation by adjuster foot

### 3.3.2 Electrical wiring

#### **WARNING**



- Do not modify the internal electrical wiring of the product. Incorrect wiring may cause an electric shock or fire. Also, modifying the internal wiring will void the product's warranty.
- NEVER connect the ground to water line, gas pipe or lightning conductor.

#### **WARNING**



- The installation of electrical equipment and wiring work should be performed only by personnel with sufficient knowledge and experience.
- Be sure to shut off the user's power supply. Wiring with the product energized is strictly prohibited.
- The wiring must be conducted using cables complying with "Table 3.3-1" and firmly secured to the product to prevent the external force of cables being applied to the terminals. Incomplete wiring, or improper securing of wiring, may cause electrical shock or excessive heat and fire.
- Ensure a stable power supply with no voltage surges.
- Ensure that an earth leakage breaker is used in the power supply of the product. See "Table 3.3-1".
- Use a power supply suitable for the specifications of the product. Use a power supply of over voltage category 3 (IEC60664-1)\*.
- Be sure to connect the ground connection.
- Ensure that a lock out facility is available on the power supply.
- Each product must have its own separate earth leakage breaker. Otherwise, there can be a risk of electric shock or fire.
- Ensure that no harmonics are superimposed at the power supply. (Do not use inverters, etc.)
- Supply a steady power supply which is not affected by surges or distortion. In particular, if the voltage rate of increase (dv/dt) at zero crossing exceeds 40V/200µsec, it may cause malfunction.

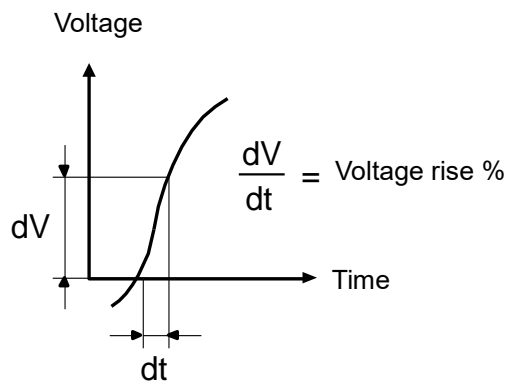

\*: For the product operation in the UL compliant conditions, please refer to "Installation/Operation in accordance with the UL standard" in the next page.

## ■ Power supply specifications, power supply cable and earth leakage breaker

Prepare the power supply shown in the following table. For the connection between the product and power supply, use the power supply cable and earth leakage breaker shown below. An earth leakage breaker must be mounted to a position where the breaker is easily accessible and close to the thermo-chiller.

Table 3.3-1 Power supply cable and earth leakage breaker (Recommended)

Model	Power supply voltage	Terminal block screw diameter	Recommended crimp terminal	Cable Specifications *1	Earth leakage breaker	
					Breaker size (A)	Sensitivity of leakage current (mA)
HRS400-A*-46-*	3-phase 380 to 415V AC (50Hz/60Hz) 3-phase 460 to 480V AC(60Hz)	M5	R5.5-5	4 cores x AWG10 (4 cores x 5.5 mm <sup>2</sup> ) *including ground	40	30

\*1 Cable specifications are the examples when using the product at a continuous allowable operating temperature of 70 °C, with an operating voltage of 600 V and two kinds of plastic insulated wires at an ambient temperature of 30 °C. Please select the proper size cables according to the actual condition.

## ■ Installation/operation in accordance with the UL standard

For the product operation in the UL compliant conditions, the conditions shown below must be satisfied:

- Use power supply of overvoltage category 2 (transient overvoltage 2500 V or less) \*1
- Bending radius of the power supply cable must be 38.1 mm or more.

\*1 When using a power supply in the overvoltage category 3, take measures such as mounting an isolation transformer between the product and the power supply or keep the transient overvoltage of the power supply to 2500 V or less by using a varistor, etc.

### 3.3.3 Preparation and wiring of power supply cable

#### **WARNING**



- The electrical facilities should be installed and wired in accordance with local laws and regulations of each country and by a person who has knowledge and experience.
- Check the power supply. Operation with voltages, capacities and frequencies other than the specified values can cause fire and electric shock.
- Wire with an applicable cable size and terminal. Forcibly mounting with an unsuitably size cable may result in heat generation or fire.

#### **WARNING**



Prior to wiring lock out and tag out the breaker of the facility power supply (customer power supply facility).

#### **WARNING**



Connect the power supply cable from the product side first, and then connect the breaker of the facility power supply (the user's machine power supply).

#### **CAUTION**



When the panel is removed or mounted, be sure to wear protective shoes and gloves to prevent injury with the edge of the panel.



**CAUTION**

A breaker that has the operating characteristic below is installed. Please use a breaker that has the same or longer operating time as/than this for the customer side (upstream side). If it has a shorter operating time, there is a possibility of accidental breaker trip due to the internal motors' inrush currents of this product.

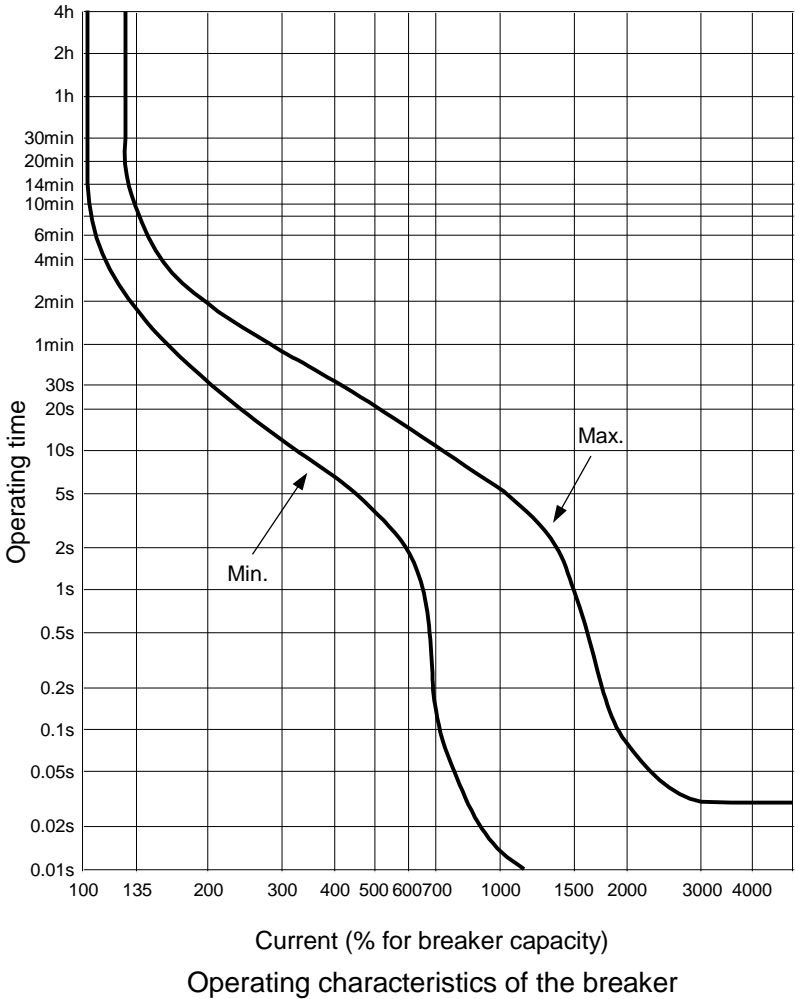

● Preparation for operation

1. Remove four screws to remove the front panel for the electrical unit.

Front panel for the electrical unit

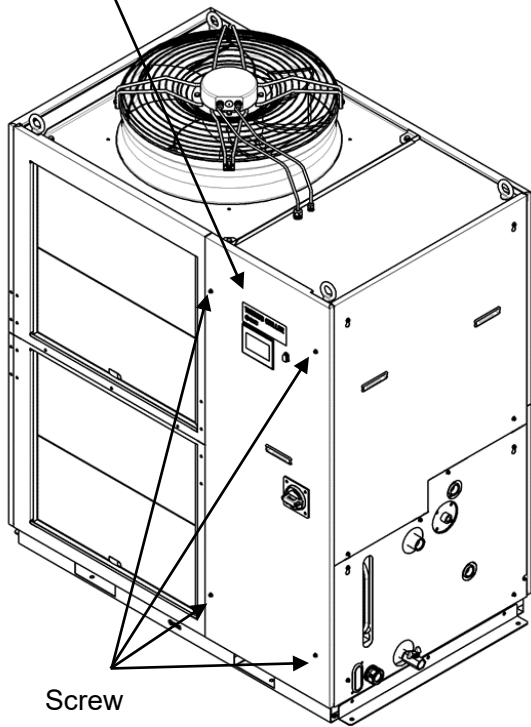

Note: Turn off the earth leakage breaker.  
The front panel of the electrical unit cannot be removed without turning off the breaker.

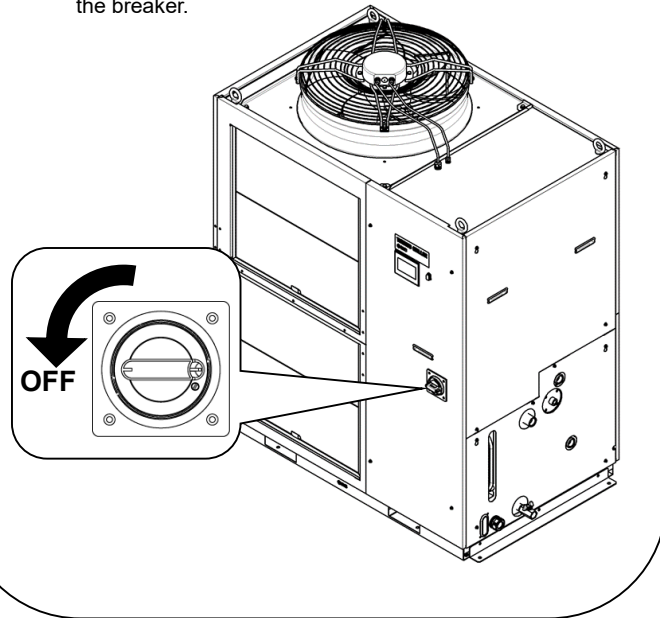

Fig. 3-6 Remove the front panel for the electrical unit

2. Hold the handle and pull up the front panel of the electrical unit, and remove it.

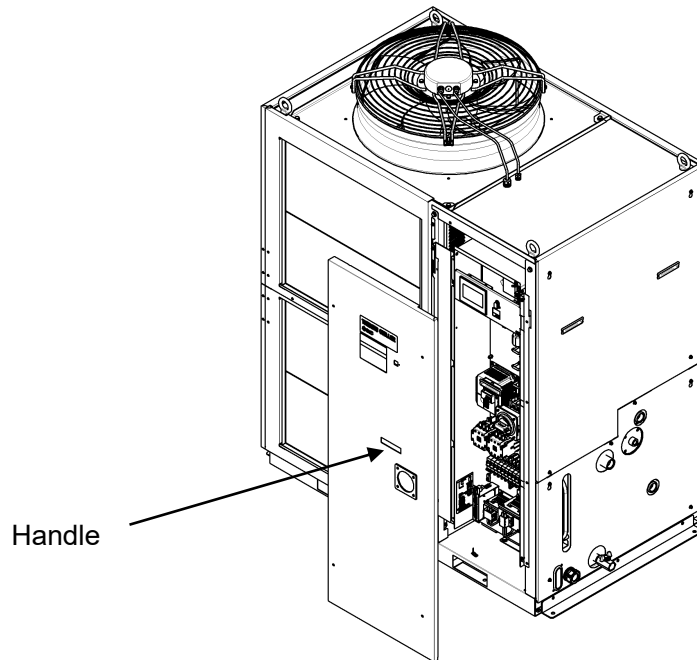

Fig. 3-7 Remove the front panel for the electrical unit

3. Loosen the power cable outlet cap and insert the power cable.

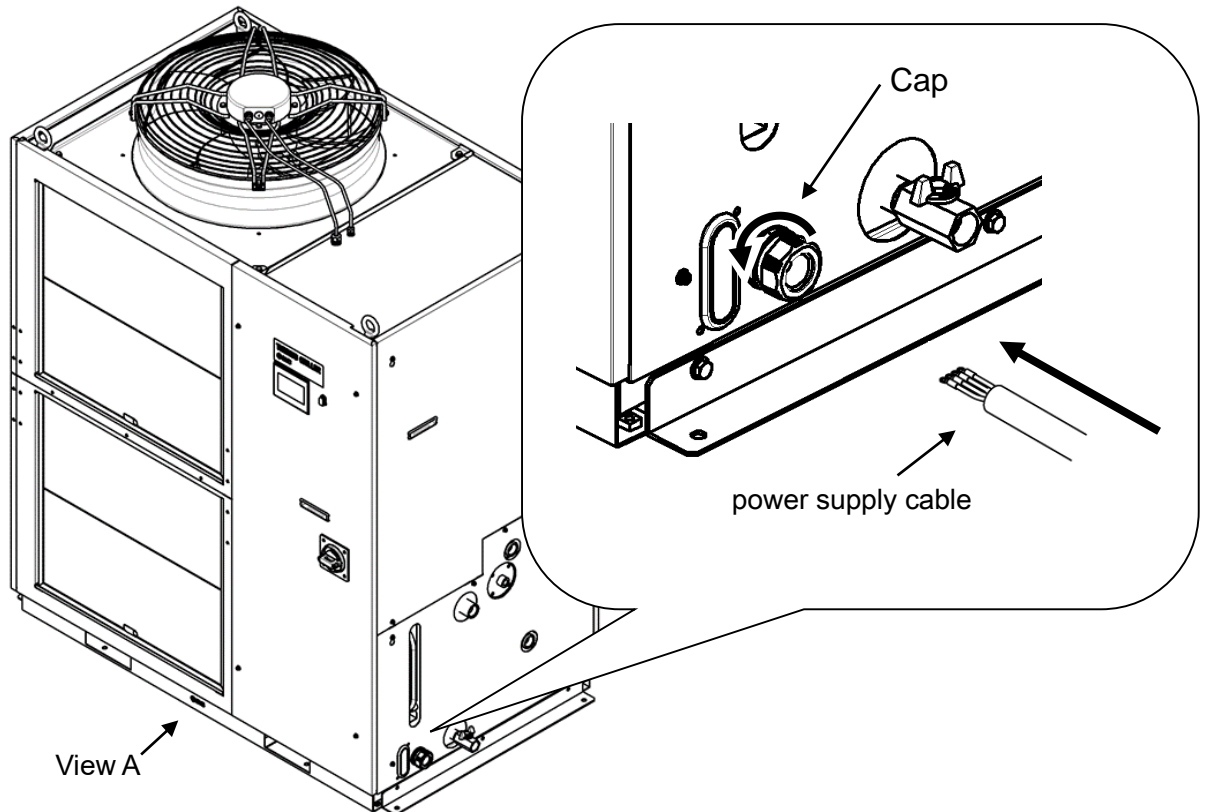

Fig. 3-8 Wiring of power supply cable

4. Connect the power supply cable and the ground cable as shown in the figure below.

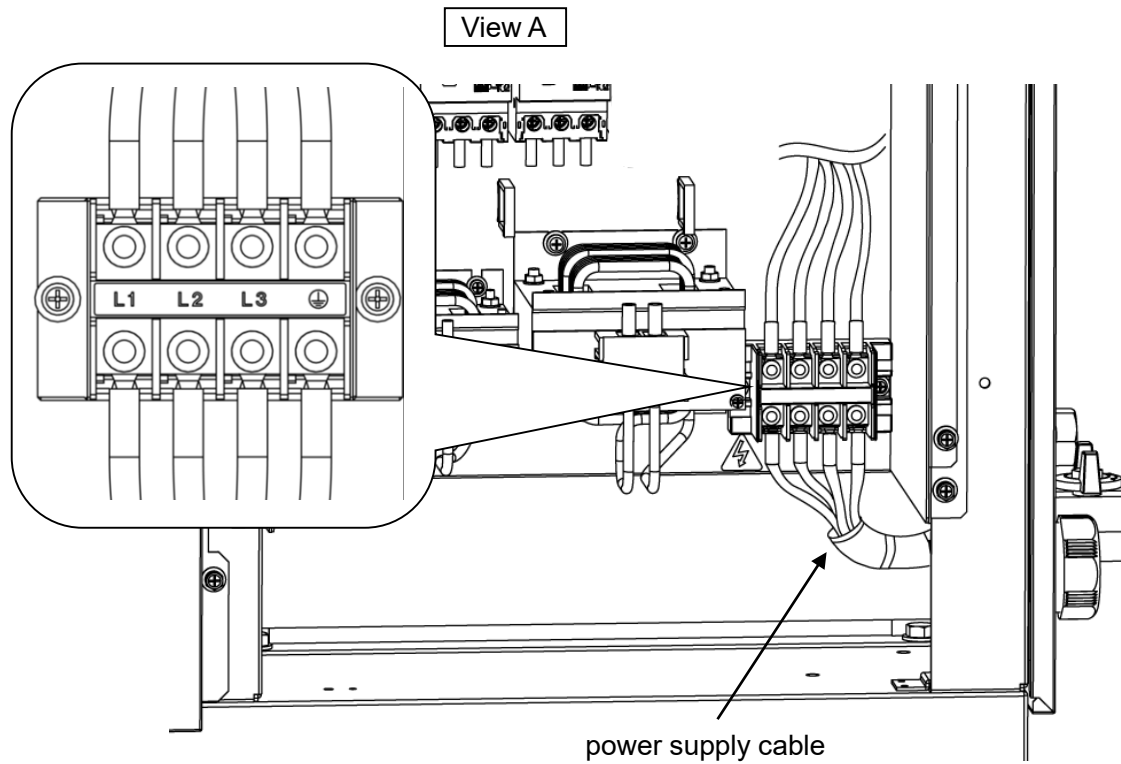

Fig. 3-9 Wiring of power supply cable

\*Connect an over current protection to the power cable connected to the equipment to avoid hazard.

### 3.3.4 Contact input/output communication wiring

<b>⚠ WARNING</b>	
	<b>Be sure to lock out and tag out the breaker of the facility power supply (the user's machine power supply) before wiring.</b>

<b>CAUTION</b>	
<ul style="list-style-type: none"><li>● Use the connectors specified.</li><li>● The capacity of the output contact of the product is limited. If the capacity is not large enough, install a relay etc. (to allow for larger capacity). Also, ensure that the input current of the relay is small enough in relation to the contact capacity of the product.</li></ul>	

The product has a contact input/output communication function as shown below. Connect cables referring to the applicable chapter for each function.

- Run/Stop input (Refer to “3.3.5 Wiring of the Run/Stop signal input”)
- Contact output signal (Refer to “3.3.6 Wiring of the contact output signal”)
- Analog output signal (Refer to “3.3.7 Wiring of analog output signal”)

Use the signal cable described below for wiring of each function.

#### Contact Input / Output communication connector

The following connectors are used for this product as a contact input / output signal connector. Please prepare suitable matching connector cable.

Table 3.3-2 Contact input/output communication connector

Connector specification (this product side)
D sub 25 pin female (socket) type Fixing bolt:M2.6x0.45

Table 3.3-3 Contact input/output/ analog output communication specification

Item		Specification	
Contact input signal 1,2,3	Electrical isolation	Photo coupler	<ul style="list-style-type: none"> <li>• Run/Stop signal</li> <li>• External switch signal</li> <li>• Operation mode request signal (Contact input 3 fixed)</li> </ul>
	Rated input voltage	DC24V	
	Operating voltage range	DC21.6V to 26.4V	
	Rated input current	5mA TYP	
	Input impedance	4.7kΩ	
Contact output signal 1,2,3,4,5,6	Rated load voltage	AC48V or less / DC30V or less	<ul style="list-style-type: none"> <li>• Signal of operating status</li> <li>• Alarm signal</li> <li>• TEMP READY signal etc. *2</li> </ul>
	Maximum load current	AC/DC 800mA or less *1	
	Minimum load current	DC5V 10mA	
Analog output signal 1,2	Output voltage range	0V to +10V	<ul style="list-style-type: none"> <li>• Circulating fluid discharge temperature</li> <li>• Circulating fluid electrical conductivity *3</li> </ul>
	Maximum output current	10mA	
	Maximum accuracy	±0.4%F.S. or less	
DC24V output voltage		DC24V±10% 200mA MAX *1 (It cannot be used for inductive load.)	

\*1 The total load current must be 800 mA or less. To use the power from the device, the total load current must be 200 mA or less.

\*2 Refer to "3.3.6 Wiring of the contact output signal"

\*3 For option D "With electrical conductivity control", it can be set.

Table 3.3-4 Contact input/output communication /Analog output pin number

PIN No.	Application	Division	Default setting
1	DC24V output	Output	—
2	DC24V input	Input	—
3	Contact input signal 1	Input	Run/Stop *1
4	Contact input signal 3	Input	Operation mode request signal (fix)*2
5	Contact output signal 6	Output	OFF*1
6	Contact output signal 1	Output	Run status signal [N.O type](fix)*2
7	Contact output signal 3	Output	Operation continuation[WRN]alarm signal [N.C. type ](fix)*2
8	Contact output signal 5	Output	OFF *1
9	None	—	Do not connect. *3
10	Analog output signal 2	Output	Circulating fluid discharge temperature signal *4
11	Analog output signal 1	Output	Circulating fluid discharge temperature signal *4
12	None	—	Do not connect. *3
13	None	—	Do not connect. *3
14	24 COM output (Common of contact input signal)	Output	—
15	Common of contact output signal 1,2,3,4,5	Output	—
16	Contact input signal 2	Input	External switch signal *1
17	None	—	Do not connect. *3
18	Common of contact output signal 6	Output	—
19	Contact output signal 2	Output	Operation stop [FLT] alarm signal [N.C. type](fix)*2
20	Contact output signal 4	Output	OFF *1
21	None	—	Do not connect. *3
22	Common of contact output signal 2	Output	—
23	Common of contact output signal 1	Output	—
24	None	—	Do not connect. *3
25	None	—	Do not connect. *3

\*1 It is possible to change the setting.

\*2 You cannot change the setting (“N.O type / N.C. type” can be changed).

\*3 Do not connect any wire

\*4 For option D “With electrical conductivity control”, It is possible to change the setting.

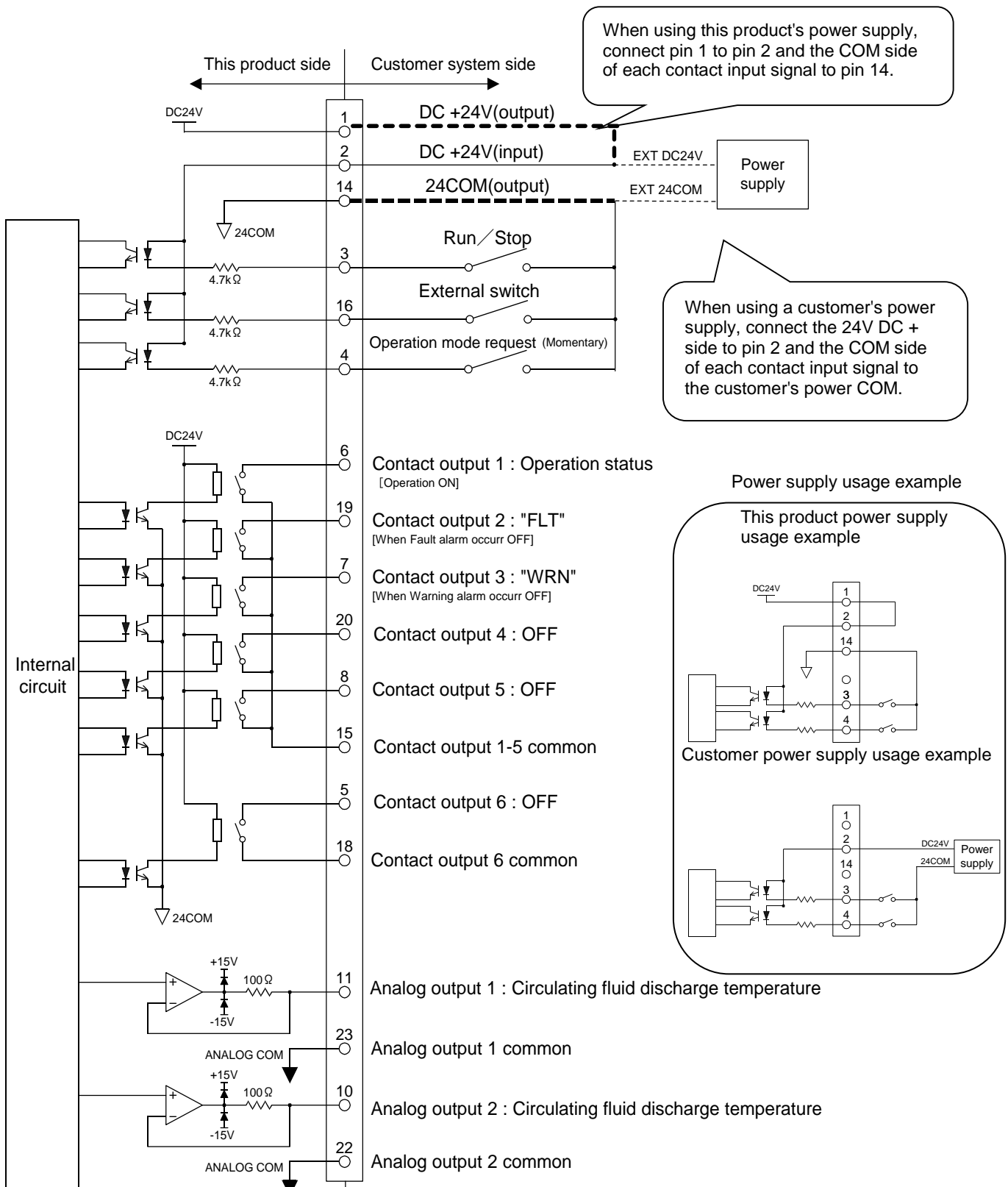

Fig. 3-10 Circuit diagram



### 3.3.5 Wiring of the Run/Stop signal input

This product can be remotely controlled by the contact signal.  
This chapter illustrates examples of wiring.

To enable Run / Stop signal input, set the operation mode to "DIO mode" after wiring. (Refer to "5.4.1 Home screen Operation mode").

**[Tips]**

---

This product has three input signals. Two of them can be customized depending on the customer's application.

---

- 
1. Prepare the switch (power supply voltage: 24 VDC, contact capacity: 35 mA or more, minimum load current: 5mA) and suitable connector cable.

- 2.** Wire the contact input / output signal connector as follows and connect it to this product. (This is a wiring example.)

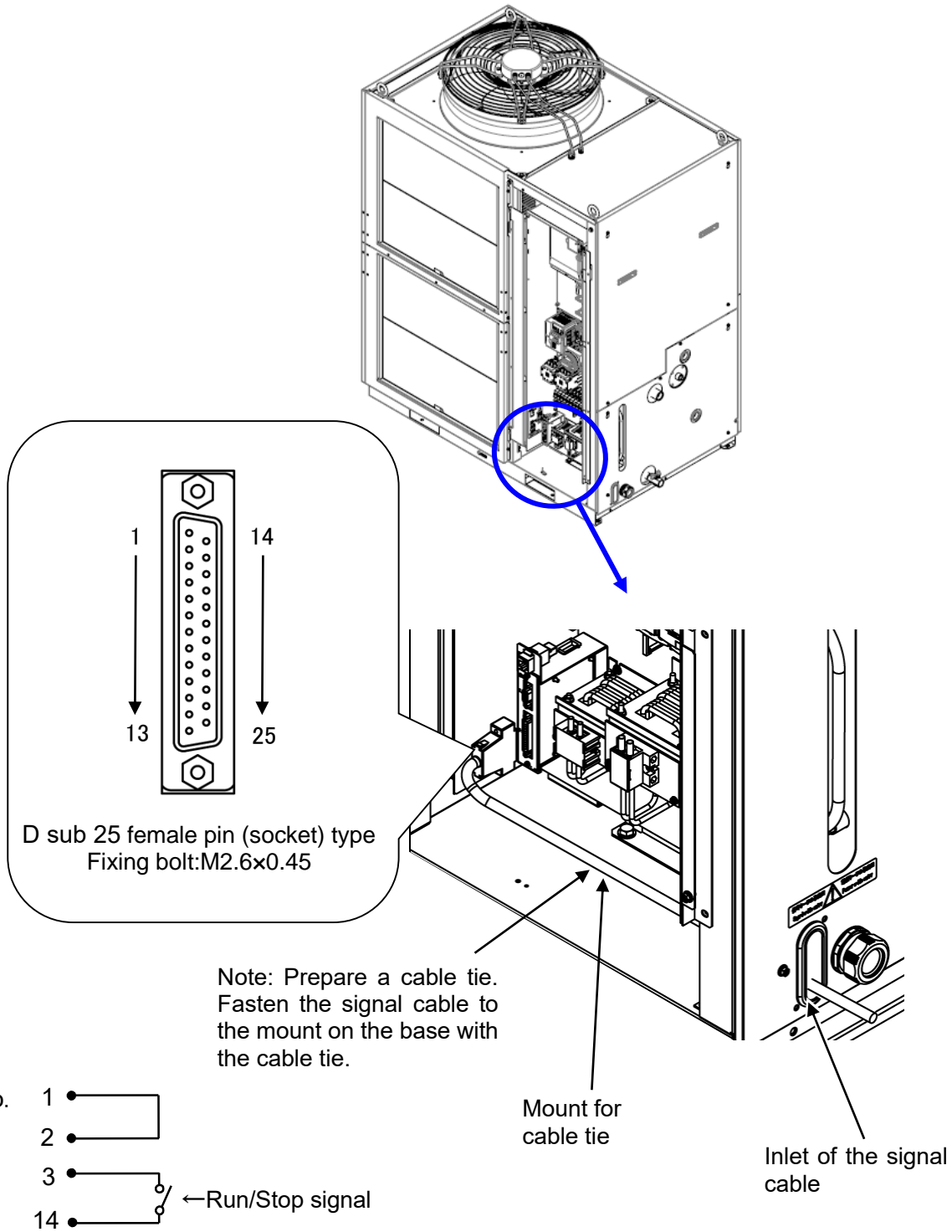

Fig. 3-11 Wiring of Run/Stop signal input and remote signal input (Example)

### 3.3.6 Wiring of the contact output signal

Contact output signals are the signals that output the status of this product. Contact specification of each signal output is shown below.

**⚠ WARNING**

**Be sure to turn OFF the breaker of the facility power supply (the user's machine power supply) before wiring.**

Contact specification of each signal output is shown below.

Table 3.3-5 Contact signal output at the factory setting

Contact output	Content of the signal (Default setting)	Operation	
Contact output signal 1	Operation status signal	N.O.	During operation: Contact closed During operation stop: Contact open Power supply cutoff: Contact open
Contact output signal 2	Operation stop [FLT] alarm signal	N.C	While alarm being generated: Contact open While alarm being generated: Contact closed Power supply shut off: Contact open
Contact output signal 3	Operation continuation[WRN] alarm signal	N.C	When alarm is being generated: Contact open When alarm is being generated: Contact closed Power supply shut off: Contact open
Contact output signal 4,5,6	OFF	—	—

#### **[Tips]**

This product has six output signals. Three of them can be customized to user's application

Signals shown below can be output. Refer to "5.4.9 Communication setting screen"

- DIO MODE signal output
- Alarm signal output
- Maintenance remainder signal output
- TEMP READY signal output
- TEMP OUT signal output
- START-UP setting signal output
- ANTI-FREEZING setting signal output
- WARMING- UP setting signal output
- Operation mode request signal status
- Selected alarm signal output
- Selected maintenance signal output

### 3.3.7 Wiring of analog output signal

This product can send output analog signals.

<b>⚠ WARNING</b>	
	<b>Be sure to turn OFF the breaker of the facility power supply (the user's machine power supply) before wiring.</b>

The analog output signal and the factory settings are as follows.

The signal content can be selected from four types. Refer to “5.4.9 Communication setting screen” for details.

Table 3.3-6 Analog output signal

No.	Signal item	Output voltage	Default setting
1	Circulating fluid temperature	0.0 to 100.0 °C: 0.00 to 10.00V	Analog output 1, 2
2	Electric conductivity *1	0.1 to 50.0μS/cm: 0.02 to 10.00V	—

\*1 : For option D “With electrical conductivity control”

### 3.3.8 RS-485 communication wiring

This product can operate the following by serial communication RS-485.

- Control of Run/Stop
- Circulating fluid temperature setting
- Circulating fluid temperature reading
- Operation status reading
- Alarm condition reading

Refer to Operation Manual Communication Function for more details.

#### ■ RS-485 communication connector

The following connector is used for this product as a connector for RS-485 communication. Please prepare suitable mating connector.

Table 3.3-7 RS-485 communication connector

Connector specification
D sub 9 pin female (socket) type Fixing bolt:M2.6x0.45

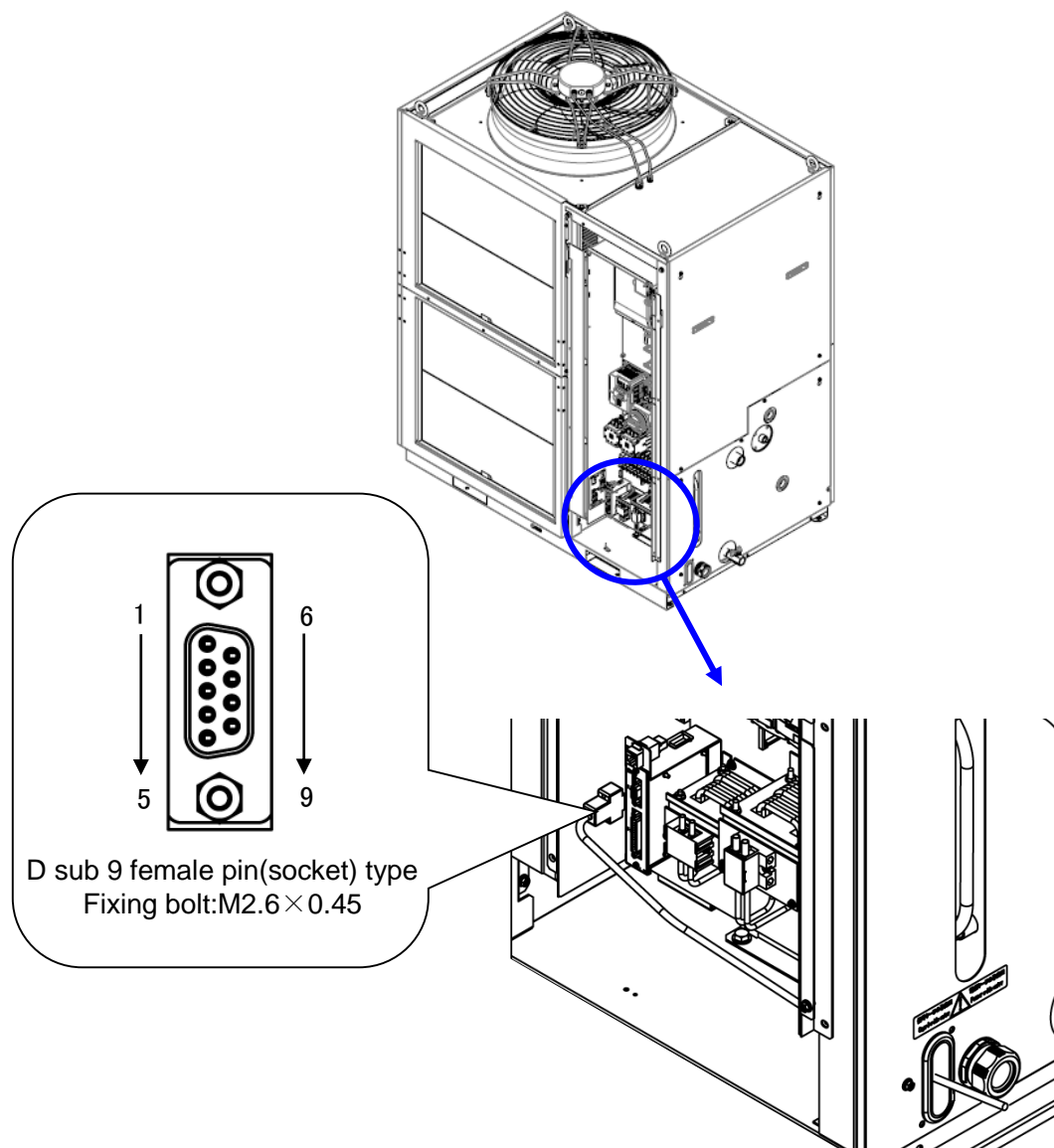

Fig. 3-12 RS-485 communication wiring

### ■ Wiring of the interface communication cable

#### **⚠ WARNING**



Be sure to turn OFF the breaker of the facility power supply (the user's machine power supply) before wiring.

#### ● Connecting to PC

RS-485 cannot be directly connected to a normal PC. Use a RS-232C/RS485 converter which is available on the market.

Be sure to follow the wiring procedure shown below for connecting multiple thermo-chillers.

● Configuration of connection

One thermo-chiller for one host computer, or multiple thermo-chillers for one host computer.

(31 thermo-chillers can be connected at maximum.)

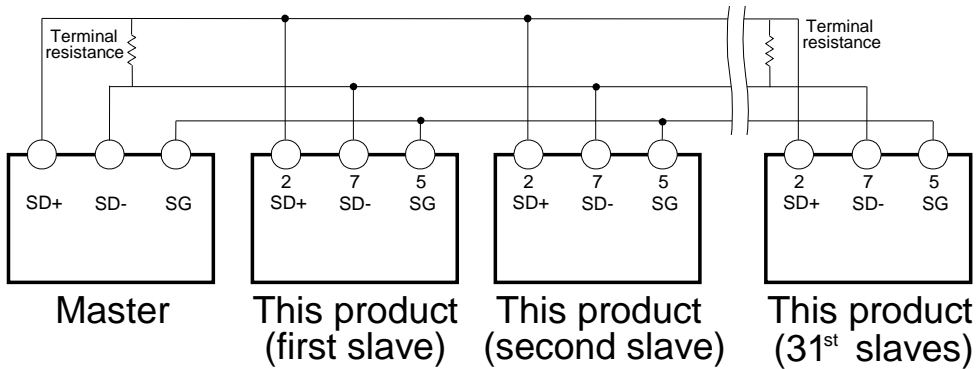

**Do not connect any wire to other PIN numbers.**

**[Tips]**

Both ends of the communication connection (the end nodes) need to be connected to the host computer.

If the terminating resistor is required, please be connected by the customer.

### 3.3.9 RS-232C communication wiring

This product can operate the following by serial communication RS-232C.

- Control of Run/Stop
- Circulating fluid temperature setting
- Circulating fluid temperature reading
- Operation status reading
- Alarm condition reading

Refer to Operation Manual Communication Function for more details.

#### ■ RS-232C communication connector

The following connector is used for this product as RS-232C communication connector. Please prepare suitable matching connector.

Table 3.3-8 communication connector

Connector specification
D sub 9 pin female (socket) type
Fixing bolt:M2.6x0.45



### 3.4 Piping

**⚠ CAUTION**



- Connect piping firmly. Incorrect piping might cause leakage of supplied or drained fluid to surrounding area and facility.
- Use caution not to allow dust and foreign matter to enter the water circuit, etc. during connection of piping.
- Securely connect the piping at the piping port with specific wrench when tightening.
- Incorrect piping can burst when in service.
- Use non-corrosive material for fluid contact parts for the circulating fluid and/or facility water. The use of corrosive materials such as aluminum or iron for fluid contact parts, such as piping, may not only lead to clogging or leakage in the circulating fluid and facility water circuits but also refrigerant leakage and other unexpected problems.
- Do not generate a rapid change of pressure by water hammer. Internal parts of the product and/or the piping may be damaged.
- It is recommended to use heat insulation to reduce the heat radiation and absorption to/from customer's piping.

**⚠ CAUTION**



- Be sure to wear protective shoes and gloves to prevent injury from the panel edges.

■ Piping port size

Table 3.4-1 Piping port size

Description	Port size	Recommended tightening torque	Recommended piping specifications
Circulating fluid outlet port	Rc1	36 to 38Nm	1.0 MPa or more
Circulating fluid return port	Rc1	36 to 38Nm	1.0 MPa or more
Automatic fluid fill port	Rc1/2	20 to 25Nm	1.0 MPa or more (Automatic fluid fill pressure: 0.2 to 0.5 MPa)
Overflow port	Rc1	36 to 38Nm	ID 25 mm or more
Tank drain port	Rc3/4	28 to 30Nm	ID 19 mm or more

**[Tips]**

**<For HRS400-AN-46-\*>**

A set of thread adapters that converts the connections from Rc to NPT is enclosed as an accessory. For NPT thread, be sure to use this adapter.

**<For HRS400-AF46-\*>**

A set of thread adapters that converts the connections from Rc to G is enclosed as an accessory. For G thread, be sure to use this adapter.



### ■ How to connect piping

Hold the each piping port with a wrench and tighten the piping.

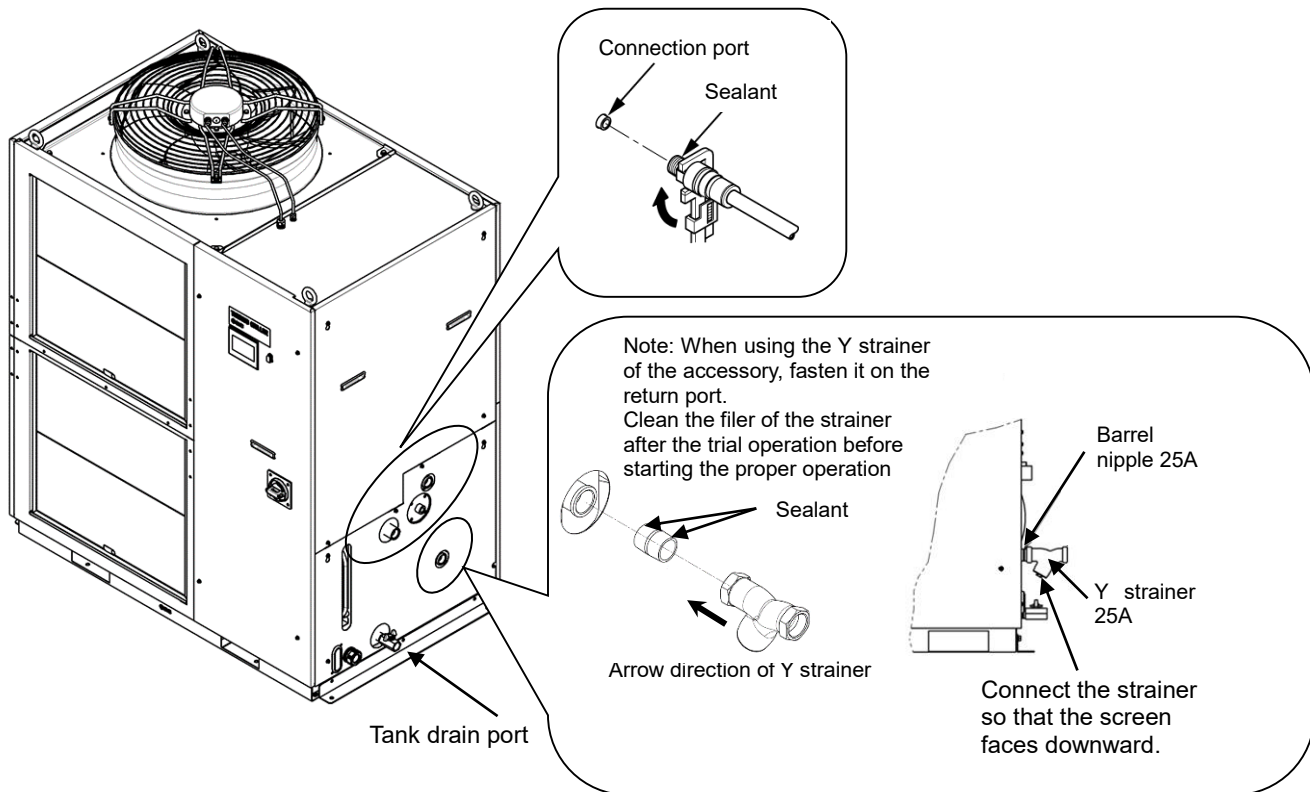

Fig. 3-14 Tightening of piping

### ■ How to connect to the drain port

When piping the drain port, hold the ball valve of the drain port with a wrench not to rotate it.

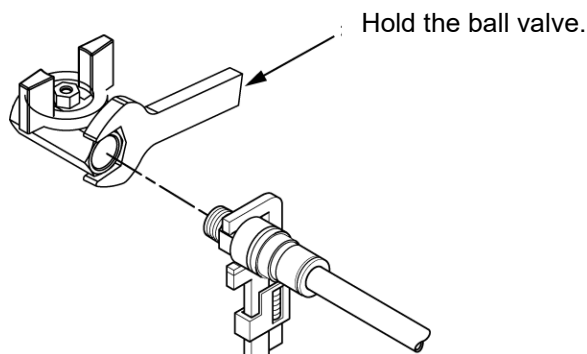

Fig. 3-15 Connection to the drain port

**⚠ CAUTION**

**Without holding the ball valve of the drain port with a wrench, the ball valve may rotate and it may cause a fluid leakage and/or malfunction of the product. Be sure to hold the ball valve of the drain port.**

■ Recommended piping circuit

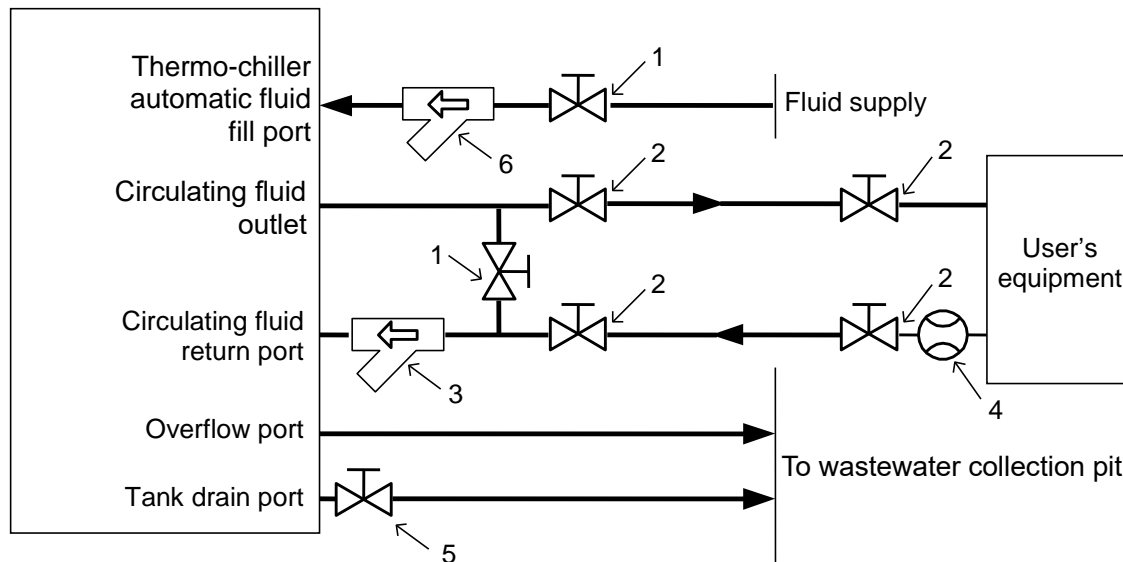

Fig. 3-16 Recommended piping circuit

No.	Description	Size	Recommended part no.	Note
1	Valve	Rc1/2	-	-
2	Valve	Rc1	-	-
3	Y-strainer	Rc1 #40	Accessory	Install either the strainer or filter. If foreign matter with a size of 20 μm or more are likely to enter, install the particle filter.
	Filter	Rc1 20μm	HRS-PF005 *	
4	Flow meter	-	-	Prepare a flow meter with an appropriate flow range.
5	Valve(Part of thermo-chiller)	Rc3/4	-	-
6	Y-strainer	Rc1/2 #40	-	Install either the strainer or filter. If foreign matter with a size of 20 μm or more are likely to enter, install the particle filter.
	Filter	Rc1/2 20μm	-	

\*The filter cannot be directly connected to the thermo-chiller. Install it in the user's piping system.

## 3.5 Circulating Fluid Supply

### 3.5.1 Automatic fluid fill function

#### CAUTION



- When clear water is used, refer to “7.1 Quality Control of Circulating Fluid and Facility Water”.
- When ethylene glycol aqueous solution is used, dilute pure ethylene glycol with water. Refer to "3.2.2 Operation at low ambient temperature or low circulating fluid temperature" for the concentration of the ethylene glycol aqueous solution. Additives such as antiseptics cannot be used.
- When deionized water is used, the conductivity should be 1  $\mu\text{S}/\text{cm}$  or higher (Electrical resistivity: 1  $\text{M}\Omega \cdot \text{cm}$  or lower).

Open the fluid supply valve that is connected to the automatic fluid fill port.  
Fluid supply starts and stops automatically with the ball tap in the tank.

#### CAUTION



- Confirm that the fluid level is between “HIGH” and “LOW” level of the fluid level gauge.
- Be sure to connect the piping from the overflow port to the drainage pit to drain excessive amount of the fluid from the tank.

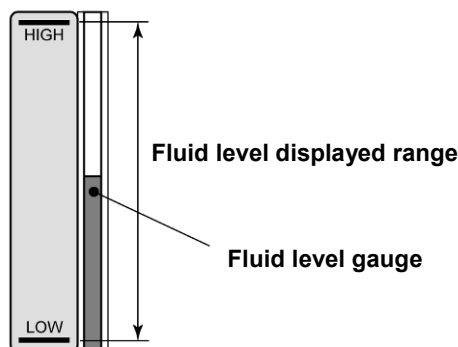

Fig. 3-17 Fluid level gauge

#### CAUTION



- Confirm that the valve of the drain port is closed to prevent the supplied circulating fluid from draining out.

#### CAUTION



- When the ambient temperature or circulating fluid temperature is 10°C or below, refer to "3.2.2 Operation at low ambient temperature or low circulating fluid temperature". Tap water may be frozen in the thermo-chiller which may damage the product.

**Ethylene glycol aqueous solution**

When ethylene glycol aqueous solution is used, prepare the ethylene glycol aqueous solution separately.

Refer to "3.2.2 Operation at low ambient temperature or low circulating fluid temperature" for the concentration of the ethylene glycol aqueous solution.

To control the concentration of the ethylene glycol aqueous solution, a densitometer is available (sold separately) from SMC.

Item	No	Remarks
Ethylene glycol aqueous solution 60%	HRZ-BR001	Dilute to with clean water (tap water).
Densitometer	HRZ-BR002	—

**CAUTION**



- When using ethylene glycol aqueous solution, check the concentration periodically because the density will be reduced due to the automatic fluid fill function.

**Piping of the overflow**

Description	Port size	Specification
Automatic fluid fill port	Rc1/2	Supply pressure: 0.2 to 0.5 MPa
Overflow port	Rc1	The piping should be $\phi 25$ mm or more and the length of 5 meters or less. Avoid riser piping (trapping part).

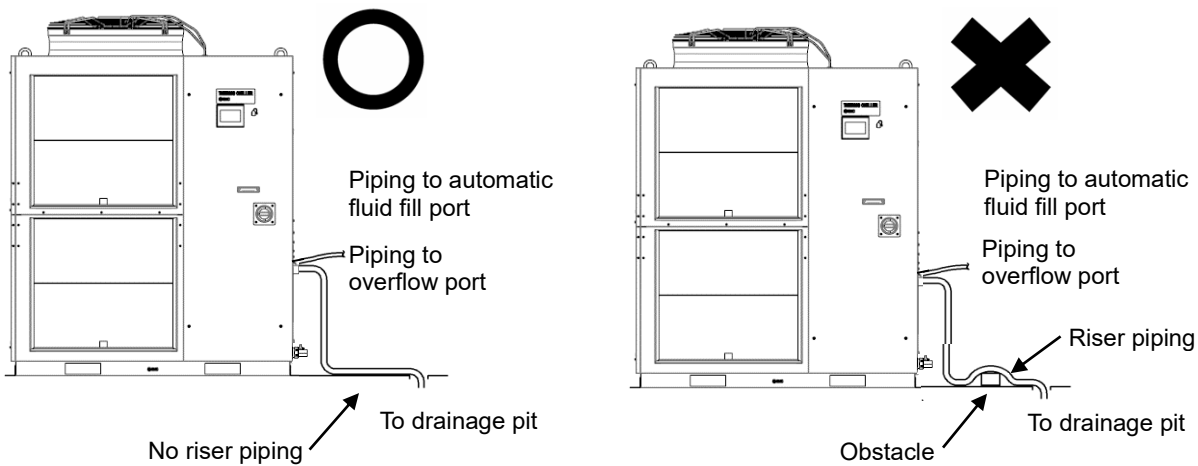



Fig. 3-18 Piping to the automatic fluid fill port and overflow port

**CAUTION**



- When using ethylene glycol aqueous solution, collect the overflowed fluid in the recycling pit and dispose it according to the local law of the country and area that the product is installed.

### 3.5.2 Fluid supply without using the automatic fluid fill function

To supply the circulating fluid without using automatic fluid fill function, remove the upper panel on the right side, and supply the fluid to the fluid fill port on top of the tank.

1. Remove the screws to remove the upper panel on the right side.

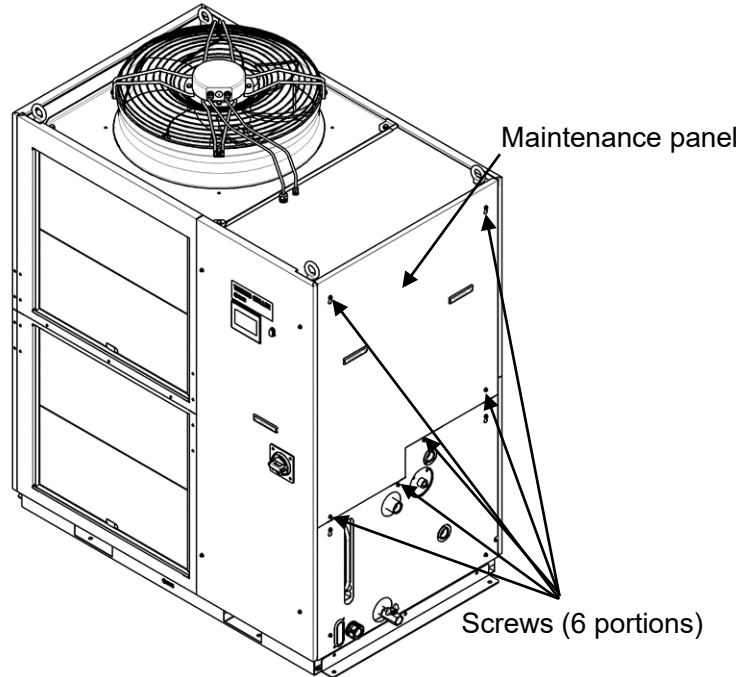

Fig. 3-19 Removal of the right side panel

2. Hold the handles and lift the upper right side panel, and remove it.

Remove the wing nuts (4 portions) on top of the tank and remove the lid also.

Note: Pay attention not to lose the wing nuts.

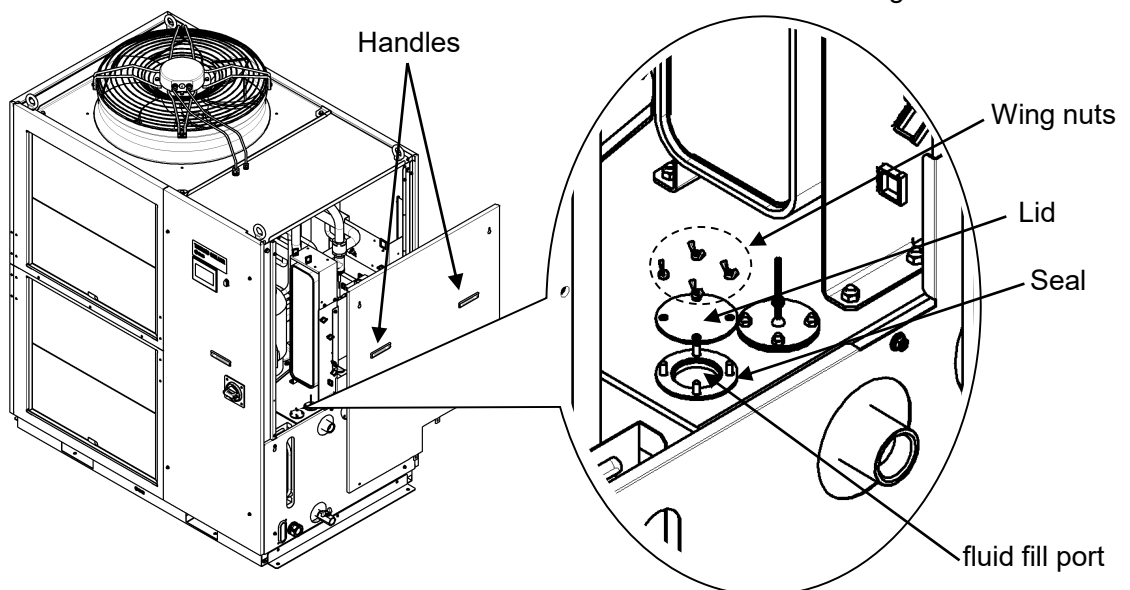



Fig. 3-20 Removal of the right side panel and the lid of the fluid fill port

**3.** Supply the circulating fluid to the fluid fill port.

**CAUTION**

 • Confirm that the fluid level is between “HIGH” and “LOW” levels of the fluid level gauge. If it exceeds the specified level, the circulating fluid will overflow.  
Be sure to connect the piping from the overflow port to the drainage pit to drain the excessive amount of the fluid from the tank.

Please supply the circulating fluid to the fluid level between “HIGH” and “LOW” levels of the fluid level gauge.

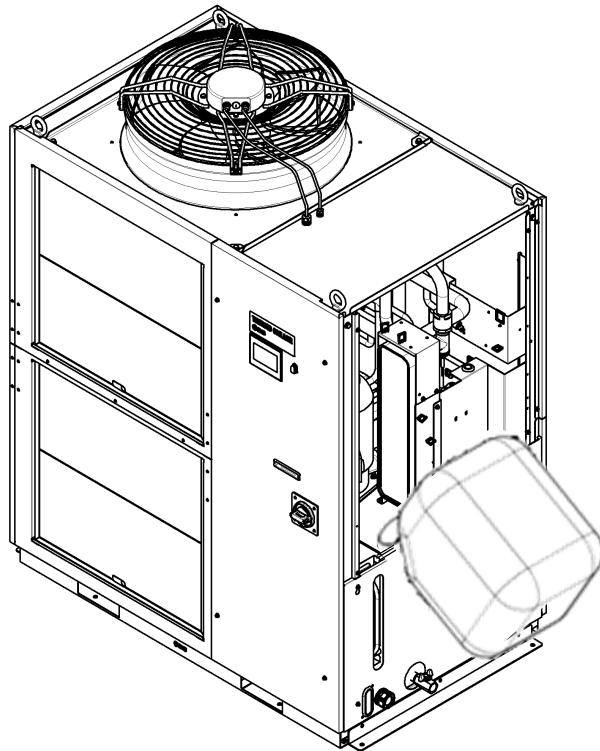



Fig. 3-21 supplying the fluid to the fluid fill port (An example)

**CAUTION**

 • Confirm that the valve of the drain port is closed to prevent the supplied circulating fluid from draining out.

### 3.5.3 Option K “Fluid fill port”

#### CAUTION



- Confirm that the fluid level is between “HIGH” and “LOW” levels of the fluid level gauge. If it exceeds the specified level, the circulating fluid will overflow.
- Be sure to connect the piping from the overflow port to the drainage pit

Open the cap of the fluid fill port and supply the circulating fluid to the fluid level between “HIGH” and “LOW” levels of the fluid level gauge.

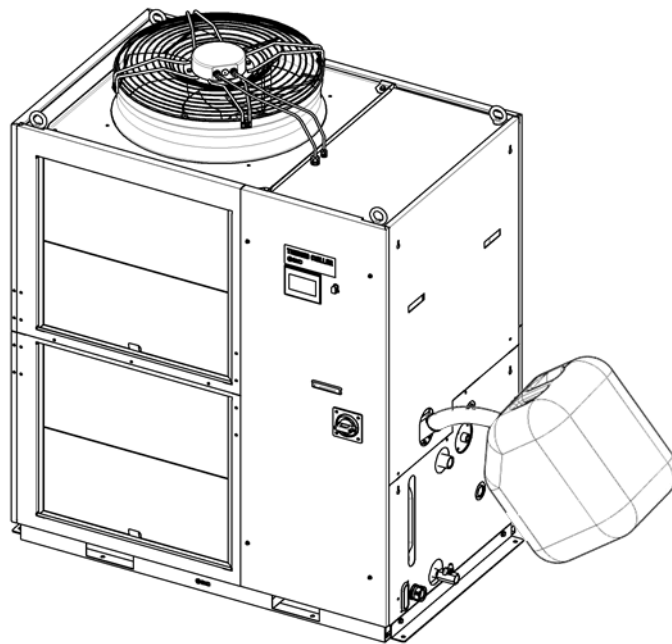

Fig. 3-22 supplying the fluid to the fluid fill port (An example)

#### CAUTION



- Confirm that the valve of the drain port is closed to prevent the supplied circulating fluid from draining out.





# Chapter 4 Starting the Product

## CAUTION



Only people who have sufficient knowledge and experience about the product and its accessories are allowed to start and stop the product.

## 4.1 Before Starting

Check the following points before starting the product.

### ■ Installation state

- Check that the product is installed horizontally.
- Check that there are no heavy objects on the product, and the external piping is not applying excessive force to the product.

### ■ Connection of the cables

- Check that the power, ground and I/O signal cables (to be supplied by user) are correctly connected.

### ■ Circulating fluid piping

- Check that the circulating fluid piping is correctly connected to the inlet and outlet.

### ■ Fluid level gauge

- Confirm that the fluid level is between “HIGH” and “LOW” levels of the fluid level gauge.

## 4.2 Preparation for Start

### 4.2.1 Power supply

Turn ON the facility power supply breaker.  
Turn ON the breaker handle.  
If the product is powered on properly, the touch panel of the product operates as follows.

- The startup screen first appears on the touch panel and then switches to the operation screen (home screen).

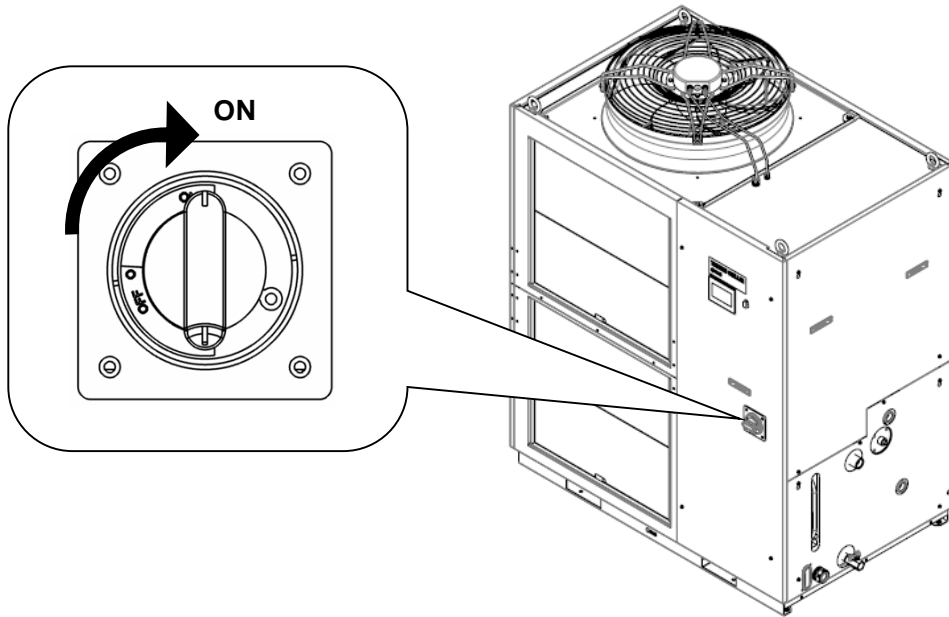

Fig. 4-1 Position of the breaker handle (This drawing shows “HRS400-A-46”)



Fig.4-2 Startup screen

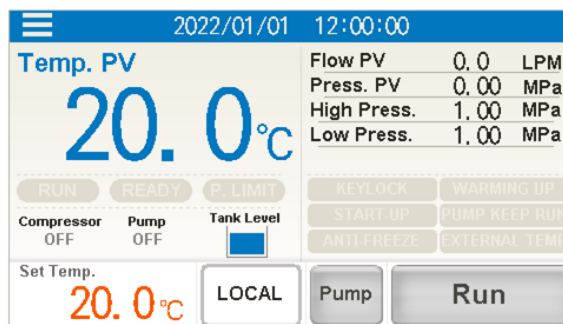

Fig.4-3 Operation screen (home screen)

## 4.2.2 Operation screen (home screen)

Items displayed on the home screen are listed in “Table 4.2-1 Items displayed on the home screen”.

Refer to “Chapter 5 Display and Setting of Various Functions” for details.

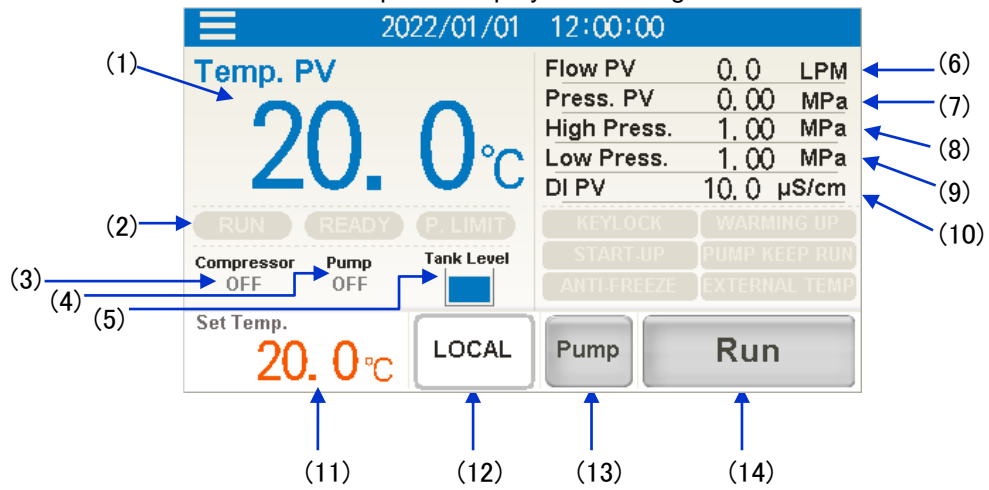



Fig.4-4 Home screen

Table 4.2-1 Items displayed on the home screen

No.	Classification	Item	Explanation
(1)	Displayed value	Current circulating fluid temperature	Displays the current temperature of circulating fluid.
(2)		Operating condition display	It indicates the run and stop status of the product.
(3)		Compressor	It indicates the run and stop status of the compressor.
(4)		Pump	It indicates the run and stop status of the pump.
(5)		Tank fluid Level	Indicates the tank fluid level with three levels: "Sufficient," "low," or "insufficient."  
(6)		Circulating fluid flow rate	It indicates the fluid flow rate. This value is not measured by a flowmeter. It should be used as a reference value (rough indication).
(7)		Circulating fluid discharge pressure	It indicates the discharge pressure
(8)		pressure gauge on high-pressure side of compressor circuit	Displays the pressure gauge on high-pressure side of refrigerant circuit.
(9)		pressure gauge on low-pressure side of compressor circuit	Displays the pressure gauge on low-pressure side of refrigerant circuit.
(10)		Circulating fluid electrical conductivity *1	It indicates the electrical conductivity.
(11)		Circulating fluid set temperature	Displays the circulating fluid temperature
(12)	Button	Operation mode	To select a operation mode from the touch panel ( LOCAL mode), contact input ( DIO mode) or serial communication ( SERIAL mode).
(13)		Independent pump operation	Pump operates independently while the button is pressed.
(14)		Run/Stop	To run/stop the product.

\*1 In the case of option D "With electrical conductivity control", to display the value.

## 4.3 Preparation of the Circulating Fluid Supply to the User's Equipment

Circulating fluid is only supplied to the product at the time of installation of the thermo-chiller. If the operation starts under this condition, the circulating fluid inside of the product is supplied to user's device and the piping. This lowers the fluid level of the product which then requires additional fluid to be supplied. Follow the instructions below to supply additional fluid.

1. Touch [  ] button on the touch panel.

Pump operates independently while pressing the [  ] button.

[  ] button lights up during independent pump operation. The circulating fluid is then supplied to user's device and the piping to bleed the air inside the piping.

### Tips

Independent pump operation is controls the pump speed to achieve the pressure set in the pressure control mode. The product does not operate at maximum rotation.

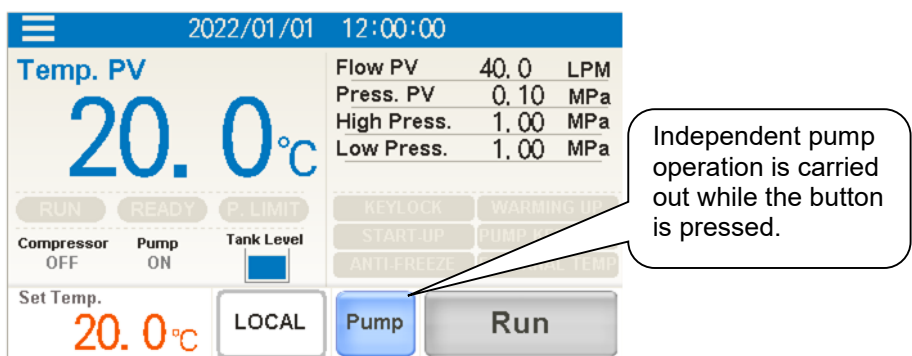

Fig.4-5 Pump independent operation

If the fluid level in the tank drops, an alarm is activated and "AL02 Low Level WRN" is displayed on the screen.

2. Supply circulating fluid in the range between HIGH and LOW to turn off the alarm.

After supplying the circulating fluid, press [  ] button to turn off the alarm.

The displayed alarm will be turned off.

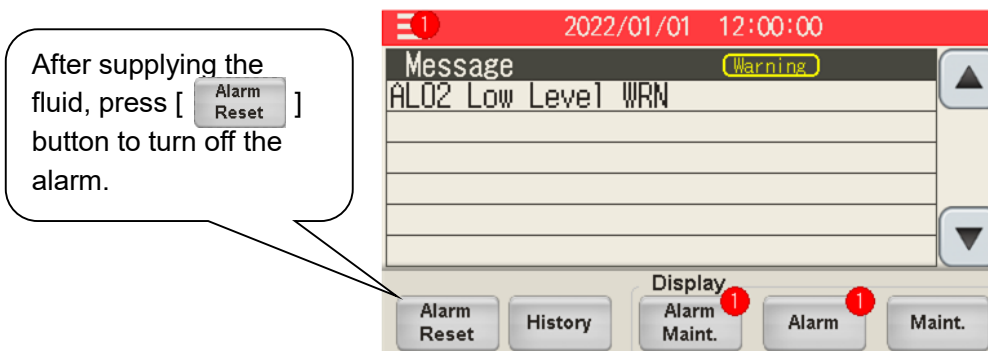



Fig. 4-6 Turning off the low tank fluid level alarm

3. Touch [  (menu key)] to display the menu.  
When [  ] button is pressed, the home screen will be displayed.

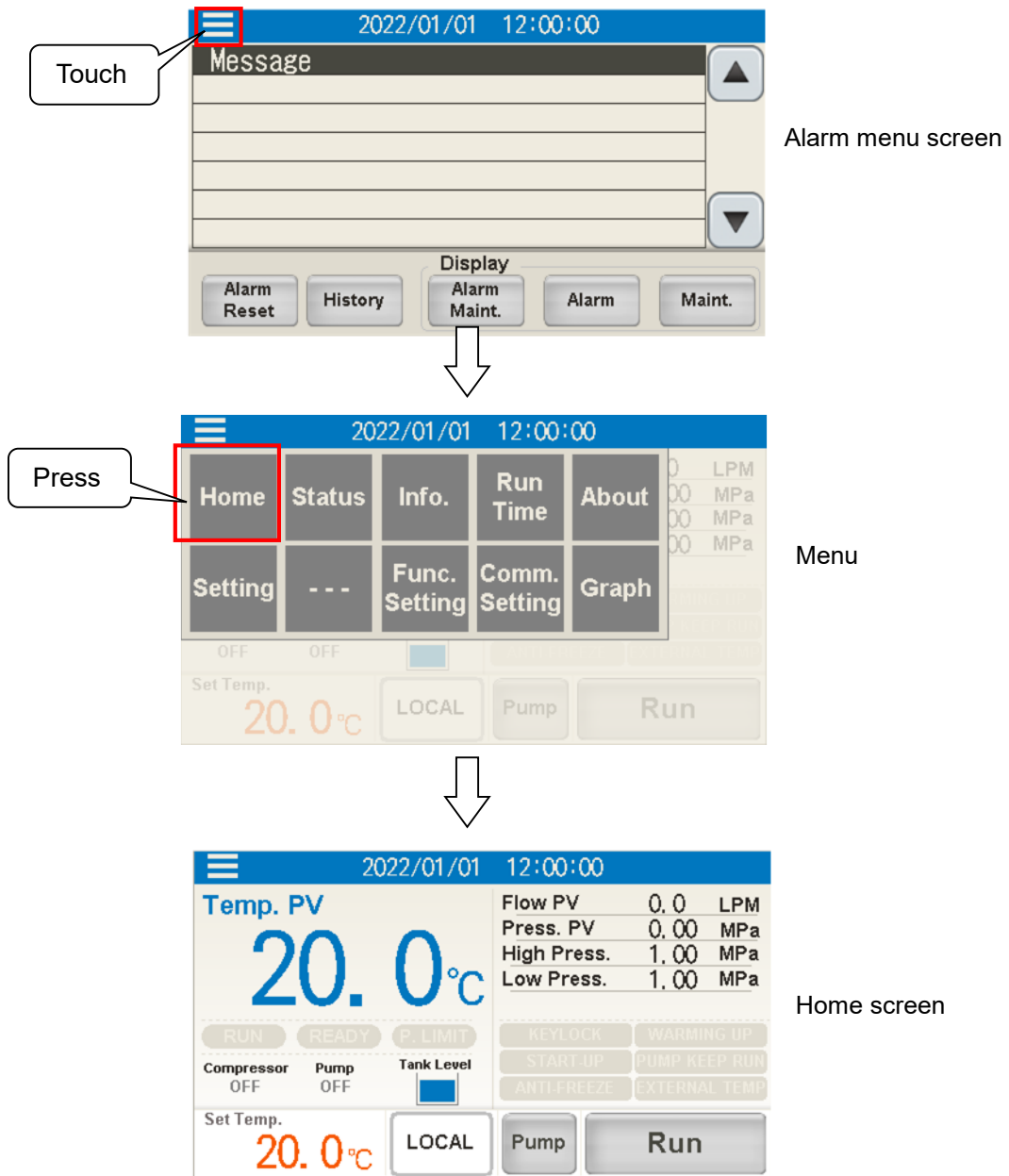

Fig. 4-7 Screen change from alarm menu to home screen

4. Repeat the procedures 1–3 until the fluid level of the product stops dropping.

**[Tips]**

While the low tank fluid level alarm (AL02) is still on (without turning off the alarm), the home screen can be displayed to carry out independent pump operation. If the fluid level continues to drop, the alarm “AL01 LOW level FLT” is activated.

## 4.4 Operation Start and Stop

### 4.4.1 Setting of circulating fluid temperature

Press the [SP] value on the touch panel (home screen) to display numeric keys to set the circulating fluid set temperature. Enter the set temperature.

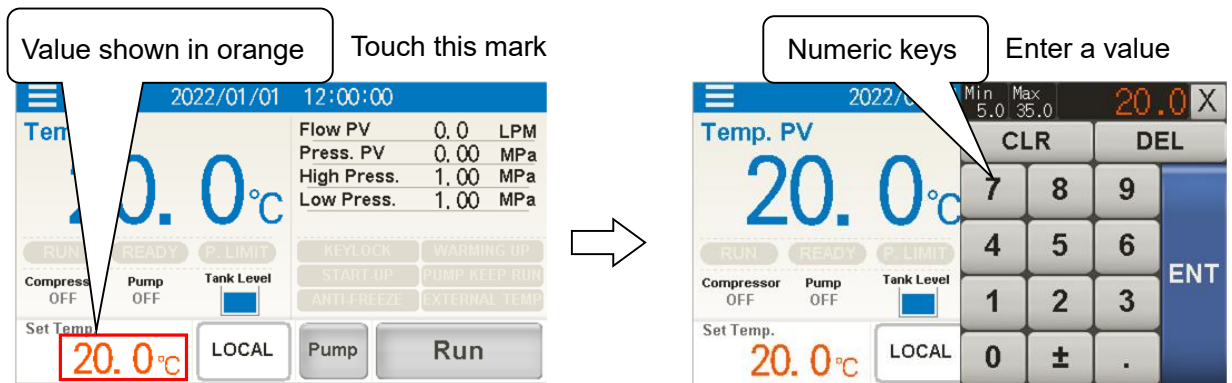

Fig. 4-8 Setting of circulating fluid temperature

### 4.4.2 Setting of the pump operation mode

Pump operation mode is set in the pressure control mode by default. Refer to “Pump operation mode” (P.5-36) for setting.

[By default] Pressure control mode

- The pump output (rotation) is controlled to maintain the circulating fluid discharge pressure at below.

HRS400: 0.45MPa

### 4.4.3 Starting the Product



**CAUTION**

!

- Allow at least 5 minutes before restarting the product.
- Operation and suspension frequency should not exceed 10 times per day. Frequently switching between operation and suspension may result in the malfunction of the refrigeration circuit.

When the alarm is activated, refer to “Chapter 6 Alarm Notifications and Troubleshooting” to turn off the applicable alarm.

1. Press [  ] button on the home screen.  
 Start the operation.

The operating condition display [  ] flashes during the operation preparation.  
 The [  ] button switches to the [  ] button as soon as operation starts.  
 The display turns on [  ] when it starts operating.

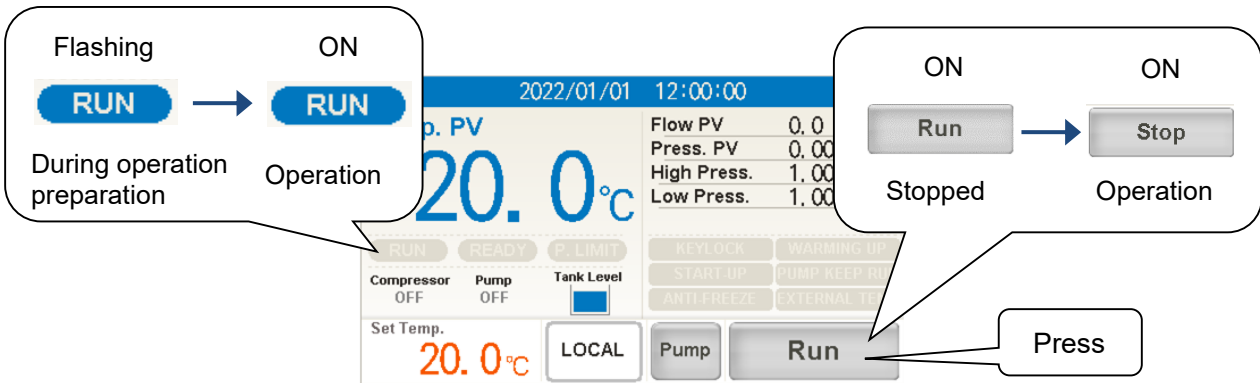

Fig.4-9 Starting the product





**CAUTION**

When an alarm is activated, refer to “Chapter 6 Alarm Notifications and Troubleshooting”.

2. Ensure that the circulating fluid flow is at least the minimum required flow rate of applicable types.

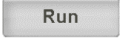

## 4.4.4 Stopping the product

1. Press [  ] button on the home screen.  
Stop the operation.  
The operating condition display [  ] flashes during the stop preparation period.  
The operating condition display switches from [  ] to [  ] as soon as the stop preparation starts.  
[  ] display turns off when it has stopped running.

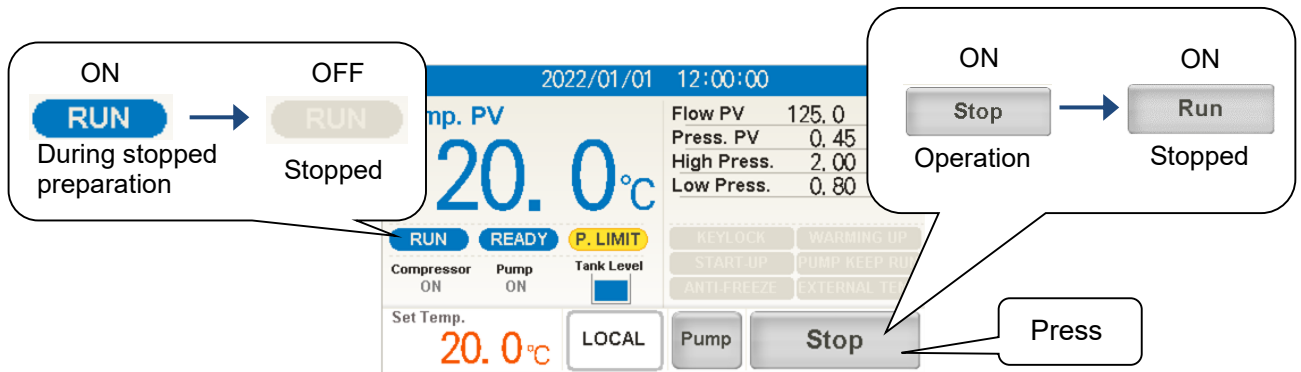



Fig. 4-10 Stopping the product

2. Please turn OFF the breaker. The touch panel turns off.

**CAUTION**



**Except in case of an emergency, do not turn OFF the breaker before the thermo-chiller operation comes to a complete stop. As this will cause damage to the product.**

## 4.5 Check Items during Startup

Check the following items after starting the product.

### **WARNING**



If abnormality is detected, press [  ] key and turn **OFF** the facility power supply (power supply of the user's equipment) breaker.

- Confirm that there is leakage from the piping.
- Confirm that no circulating fluid is discharged from the tank drain port.
- Confirm that the circulating fluid pressure is within the specification range.
- The fluid level is within the range.

## 4.6 Adjusting the Circulating Fluid Flow Rate

If the circulating fluid flow rate is smaller than the minimum required, the product may fail to maintain performance, making it impossible for the compressor to operate. Refer to Figure 3-16 to find the recommended piping circuit fluid flow rate for adjustment, and adjust the manual valve while monitoring the pressure and flow rate of the user's equipment to achieve the required pressure or flow rate.

### **Tips**

Refer to "8.1 Specifications" for the minimum required flow rate.

---

# Chapter 5 Display and Setting of Various Functions

**⚠ WARNING**

**!** Thoroughly read and understand this manual before changing settings.

## 5.1 Basic Operation

### 5.1.1 Touch panel

The basic operations of the product are controlled by the touch panel on the front of the product.

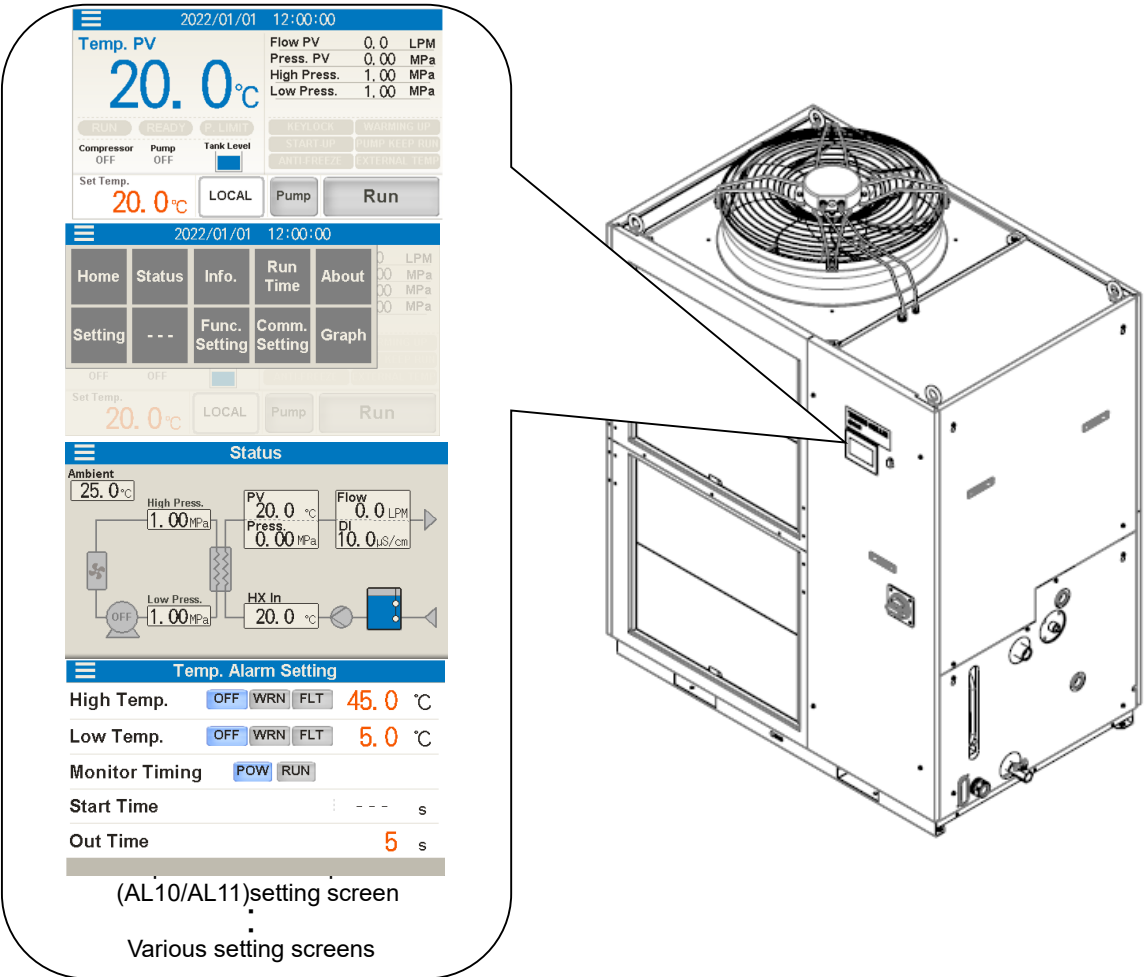

Fig.5-1 Touch panel

**CAUTION**

**!** Be sure to operate the touch panel only with your fingers. Operating the panel with a sharp pointed screwdriver or ballpoint pen damages the panel.

### 5.1.2 Basic operating instructions

Basic operating instructions for the touch panel of the product are described below.

1. After turning on the power, the startup screen appears on the display and changes to the home screen.

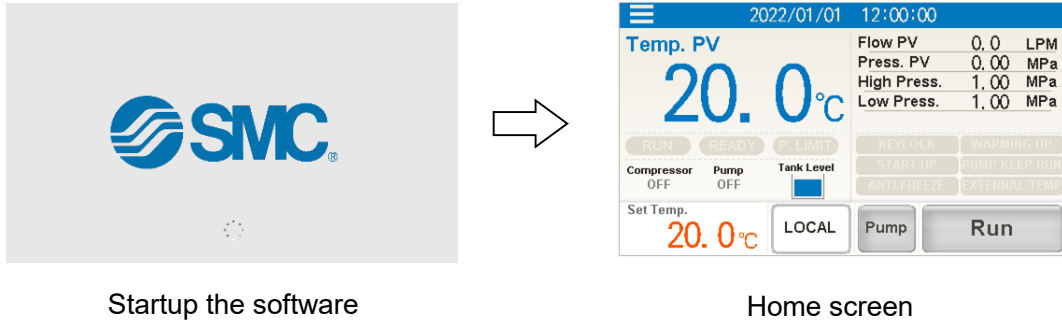

Startup the software

Home screen

2. Settings and screen display can be reviewed after the home screen changes to the respective screen. The menu is displayed when [ ] (menu key) located upper left on the screen is touched. Go to the respective screen from the menu to check the settings and screen display content.

Essentially use [ ] key to change the screen. [ ] key is located on every screen.

The menu is closed when [ ] key is touched while the menu is displayed.

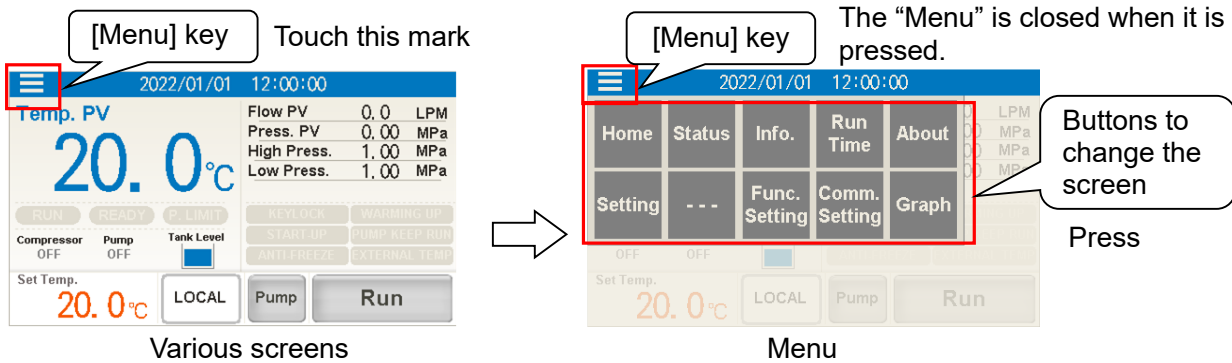

Various screens

Menu

3. Press a button for example to carry out “Run/Stop,” “Selection of function” or “Change the screen. Any button-shaped section on the screen can be pressed to operate it.

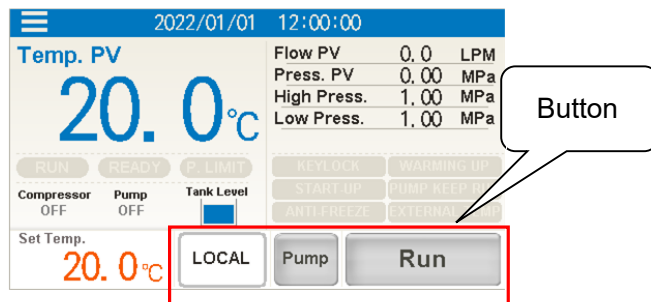

“Button” examples

4. Touch the value in orange to display numeric keys to enter a value. Enter a set value.

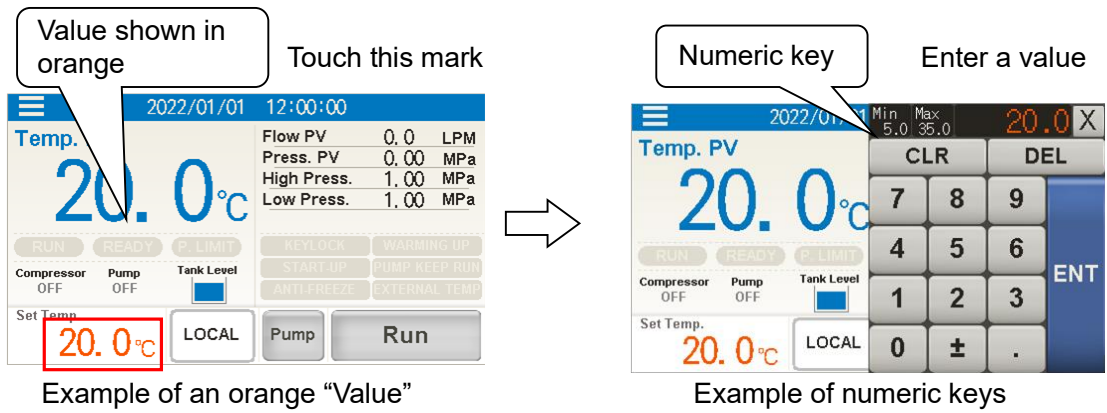

## 5.2 Flow Chart of the Operation Screen

### 5.2.1 Flow Chart of the Operation Screen

Flow chart of operation screens (touch panels) of the product are shown in from Fig.5-2 Flow chart of operation screen (1/3) to Fig.5-4 Flow chart of operation screen (3/3).

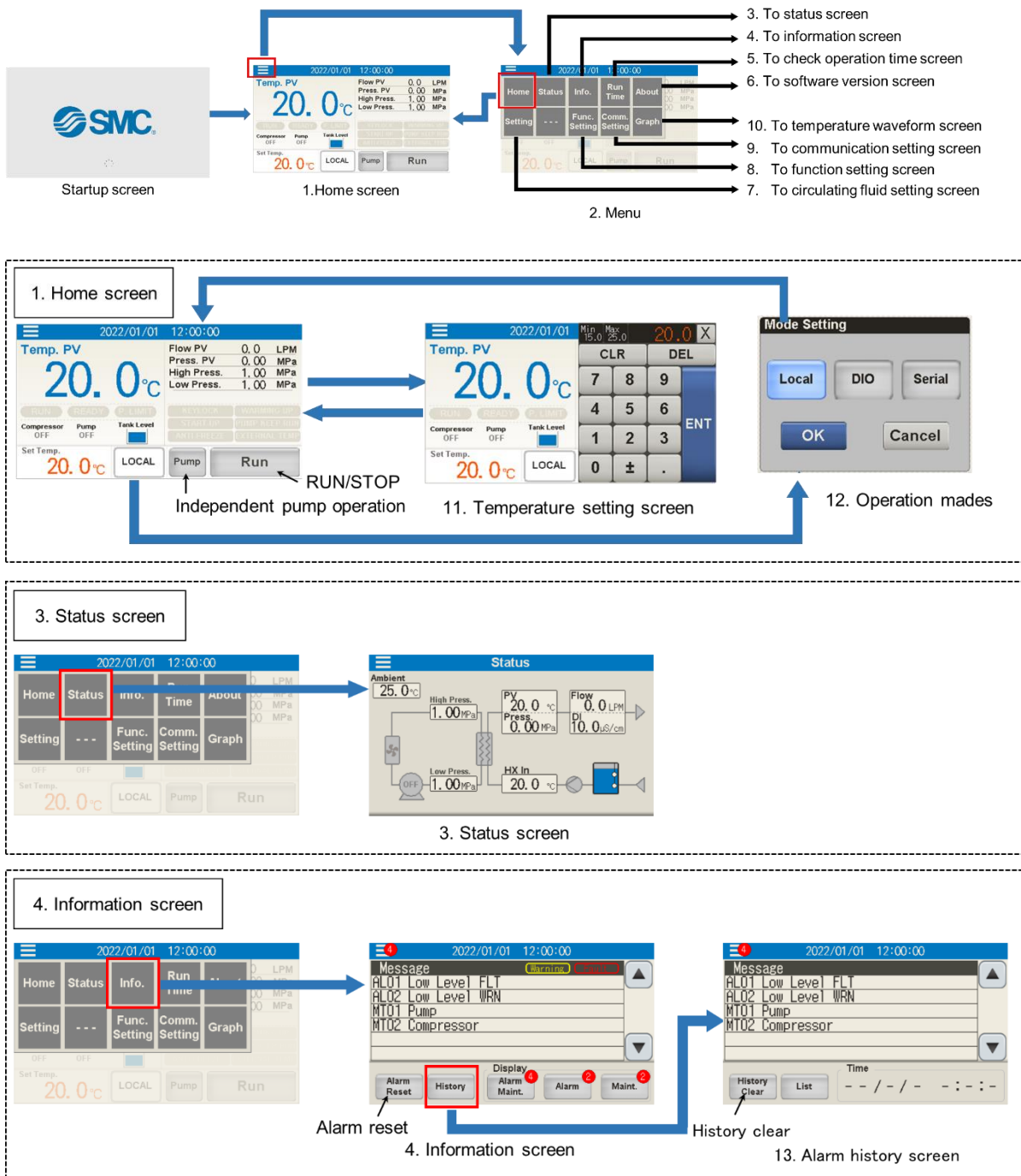

Fig.5-2 Flow chart of operation screen (1/3)

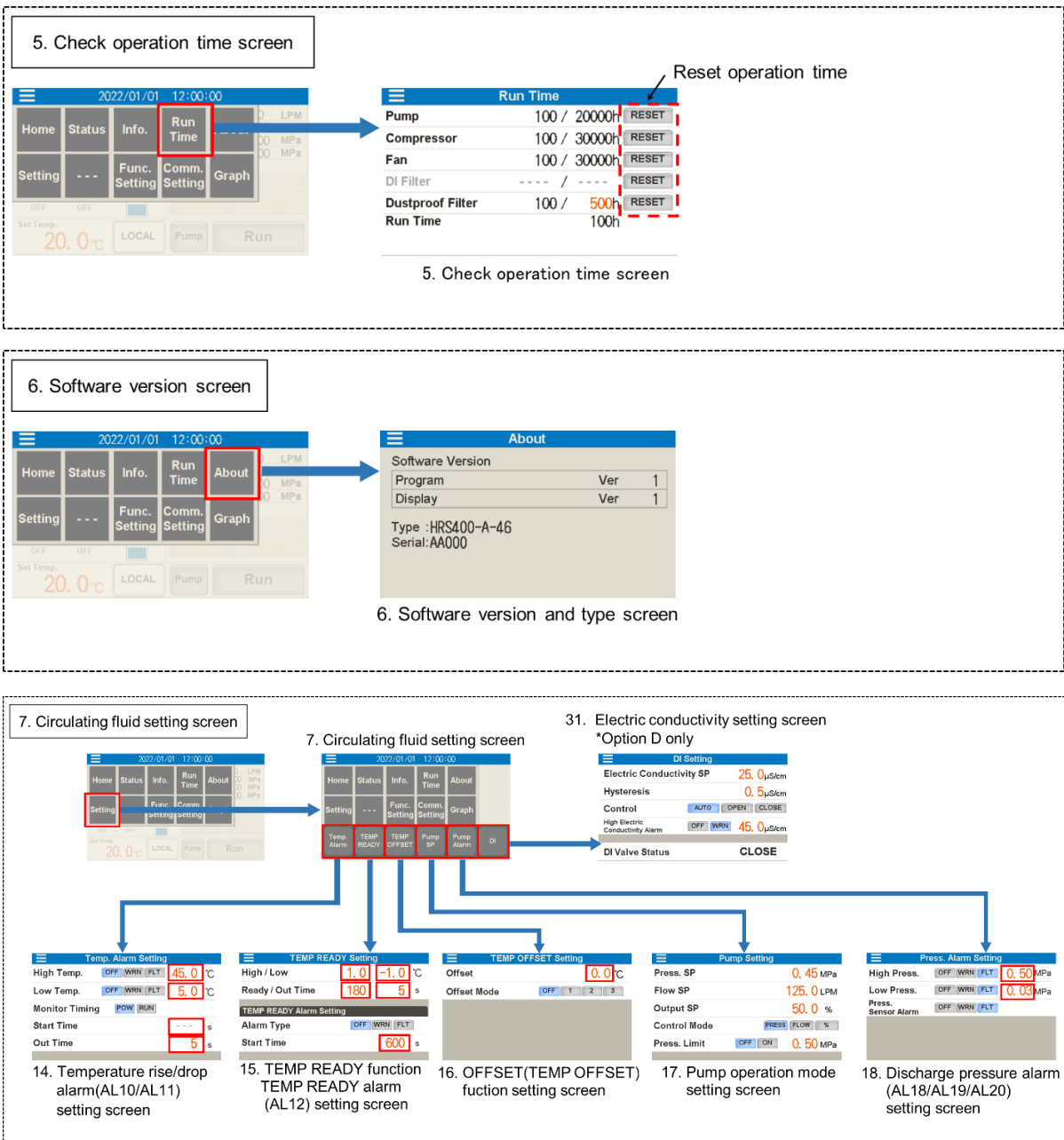

Fig.5-3 Flow chart of operation screen (2/3)

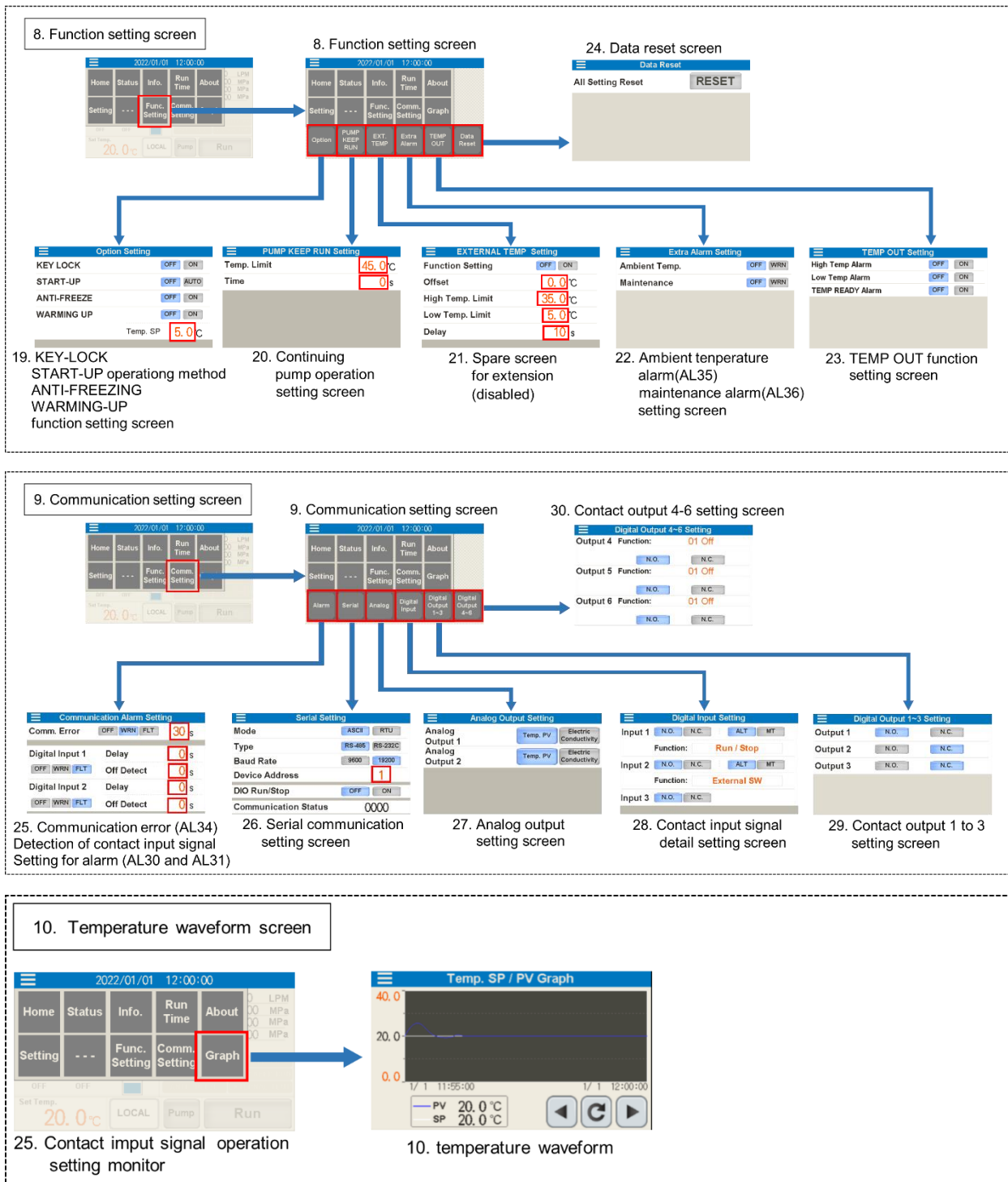

Fig. 5-4 Flow chart of operation screen (3/3)



## 5.3 List of Functions

Function of the product can be set as shown in Table 5.3-1 List of functions.

Table 5.3-1 List of functions

No.	Classification	Function	Outline	Reference page
1	Home screen	Temperature setting	Allows change of the set circulating fluid temperature.	Chapter 5.4.1
		Temperature display	Displays the circulating fluid temperature.	
		Pressure display	Displays the circulating fluid discharge pressure.	
		Flow rate display	Displays the circulating fluid flow rate as a guide.	
		Run/Stop	Run/stop the product.	
		Pump independent operation	Independently operates the pump.	
		Operation mode selection	• Displays the operation mode. • Selects the operation from touch panel or communication.	
		Operating condition display	Displays the operating status.	
2	Menu	Menu display	Selects a menu for various settings.	Chapter 5.4.2
3	Status screen	Sensor value display	Displays the sensor value of the product.	Chapter 5.4.3
4	Information screen	Alarm/maintenance display	Displays an alarm name when the alarm goes off. Displays a maintenance reminder. Displays previously activated alarms.	Chapter 5.4.4
5	Check operation time screen	Check operation time	Following operation times can be checked: The operation time can be reset. • Pump • Compressor • Fan • Time of use of DI filter • Time of use of dustproof filter	Chapter 5.4.5
		Reset operation time		
6	Software version screen	Display of software version	Software version can be checked.	Chapter 5.4.6
7	Circulating fluid setting screen	Temperature rise/drop alarm	Sets the temperature rise/drop alarm (AL10/AL11).	Chapter 5.4.7
		TEMP READY function	Sets TEMP READY signal and alarm (AL12).	
		TEMP OFFSET	Sets the offset mode.	
		Pump operation mode	Sets the pump operation mode and set value.	
		Discharge pressure rise/drop alarm	Sets the pump discharge pressure rise/drop alarm (AL19/AL20) and discharge pressure sensor failure (AL18).	
Electric conductivity	Sets the electric conductivity.*1			
8	Function setting screen	KEY LOCK	Prevents operations other than "run/stop", "charge screen" and "alarm reset".	Chapter 5.4.8
		START-UP	Selects the operating method to turn on the power.	
		ANTI-FREEZE	Sets the anti-freezeing operation.	
		WARMING UP	Sets the warming up.	
		PUMP KEEP RUN	Sets the pump continuing operation function.	
		Ambient temperature alarm	Selects the enabling/disabling of ambient temperature alarm (AL35).	
		Maintenance alarm	Sets the assignment of "maintenance reminder" as an alarm signal (AL36).	
		TEMP OUT function setting	Sets TEMP OUT function.	
Data reset	Resets set values to default settings.			
9	Communication setting screen	Communication alarm	Sets the communication error (AL34) and connect input 1 and 2 signal detection (AL30/AL31).	Chapter 5.4.9
		Serial communication	Sets RS-232C and RS-485.	
		Analogue output	Sets the analogue output.	
		Contact input signal	Sets the contact input signal.	
		Contact output signal	Sets the contact output signal.	

\*1 Only for Option D "With electrical conductivity control"

## 5.4 Description of the Screen

### 5.4.1 Home screen

Items displayed on the home screen and setting items are shown in Table 5.4-1 List of check items in inspection monitor menu.

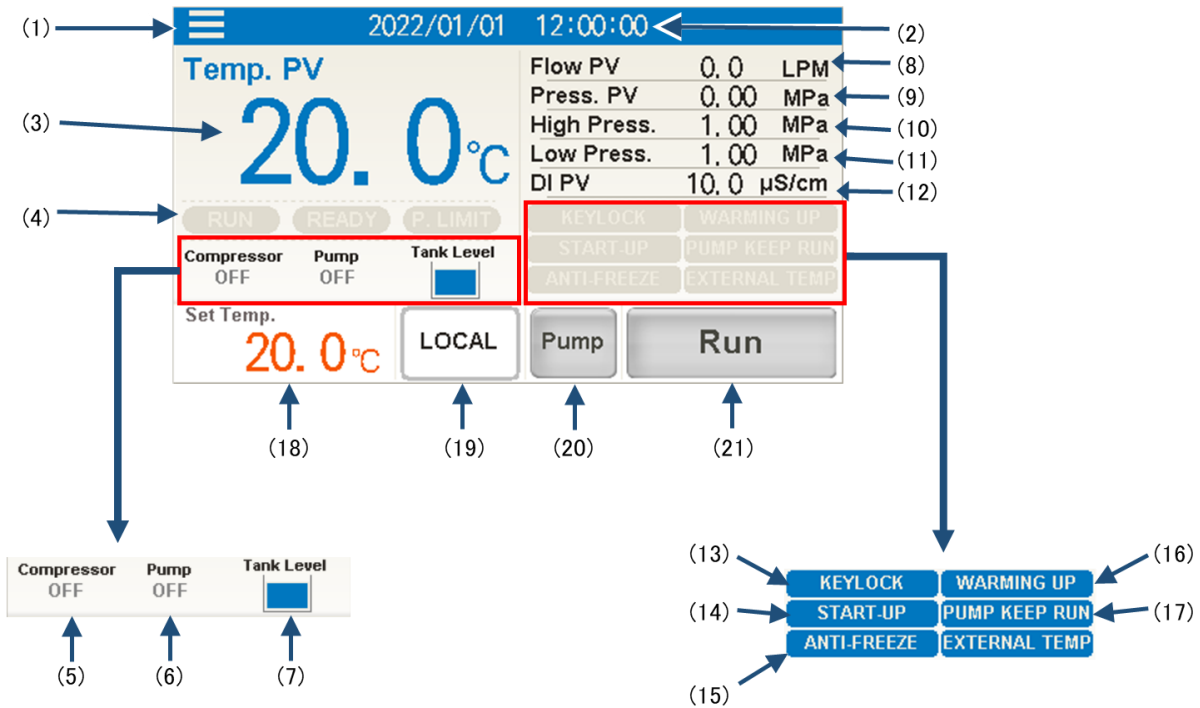

Home screen

Table5.4-1 List of check items in inspection monitor menu

No.	Item	Explanation	Reference page
(1)	Menu key	Touch the key to display the menu.	P.5-10
(2)	Date and time display	Displays the date and time. Press the numeric section to set the date.	P.5-10
(3)	Current circulating fluid temperature	Display circulating fluid temperature.	P.5-10
(4)	Operating condition display	Displays TEMP READY status. Displays the control status of the circulating fluid temperature. Displays the run and stop status of the product.	P.5-11
(5)	Compressor operating condition display	Displays the run and stop status of the compressor.	P.5-11
(6)	Pump Operating condition display	Displays the run and stop status of the pump.	P.5-11
(7)	Tank fluid Level	Displays the tank liquid level in three levels: "sufficient," "low," and "insufficient." 	P.5-12
(8)	Circulating fluid temperature	Displays the fluid flow rate. This value is not measured by a flowmeter. It should be used as a reference value (rough indication). Displays the flow rate in the bypass circuit.	P.5-12
(9)	Circulating fluid discharge pressure	Displays the discharge pressure.	P.5-12
(10)	Compressor circuit High pressure side	Displays the High pressure side of refrigeration circuit	P.5-12
(11)	Compressor circuit Low pressure side	Displays the Low pressure side of refrigeration circuit	P.5-13
(12)	Circulating fluid electrical conductivity *1	Displays the electrical conductivity.	P.5-13
(13)	Key lock condition display	Displays the status of key lock settings.	P.5-13
(14)	Startup operation status display	Displays the status of operation settings at startup	P.5-14
(15)	Anti-freezing status display	Displays the status of anti-freezing settings.	P.5-14
(16)	Warming up status display	Displays the status of the warm-up settings.	P.5-14
(17)	Pump operation continuation status display	Displays the status of pump operation continuation setting.	P.5-15
(18)	Circulating fluid set temperature	Displays the set temperature. Press the numeric section to change the set temperature.	P.5-15
(19)	Operation mode	To select a operation mode from the touch panel( LOCAL mode), contact input ( SERIAL mode) or serial communication ( DIO mode).	P.5-16
(20)	Independent pump operation	Pump operates independently while the button is pressed.	P.5-16

\*1 In the case of option D "With electrical conductivity control", to display the value.

•Menu key

**1.** Touch [  ] (menu) key to display the menu.

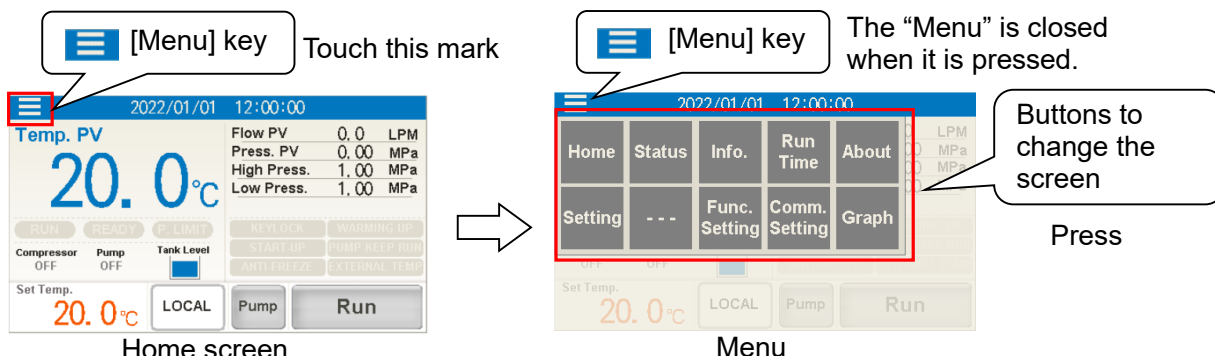

•Display and setting of date and time

**2.** Touch the date and time display to set the date and time.

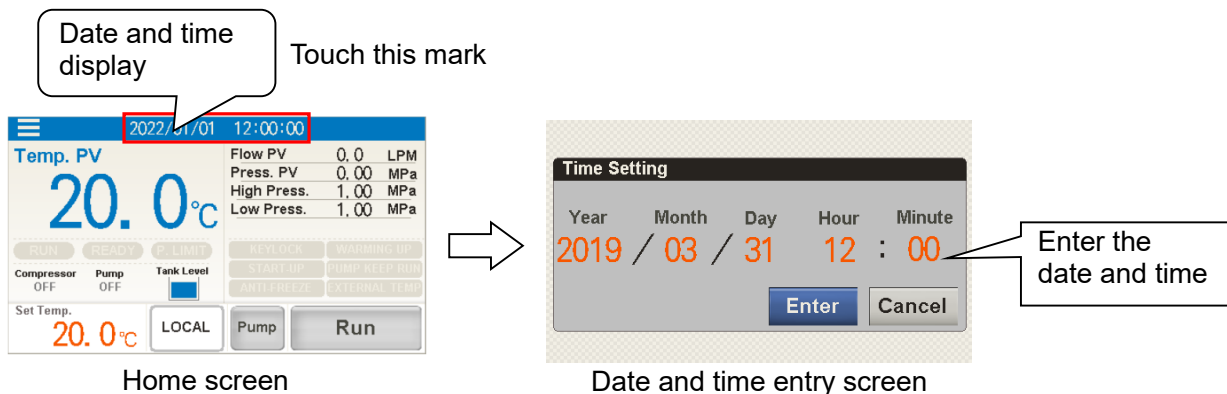

•Current circulating fluid temperature [PV]Circulating fluid set temperature [SP]

**3.** Display the current circulating fluid temperature.

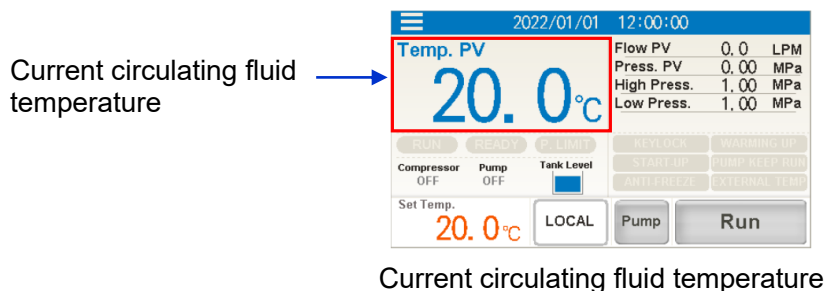

•Operating condition display

**4.** Indicates whether the product is running or has stopped running.

Display “TEMP READY status” and “PRESS LIMIT status”.

Display [ **Ready** ] if the current temperature is within a certain range. (Refer to “■ About TEMP READY function” (P.5-32) for “TEMP READY function”.) Display [ **P. Limit** ] if the circulating fluid discharge pressure has reached the pressure limit value. (Refer to “■About control function of circulating fluid discharge pressure” (P.5-36) for details of “PRESS LIMIT”.)

Run / stop status display

“Ready” / “P. Limit” display

•Compressor operating condition display

**5.** Displays the run and stop status of the compressor.

ON/OFF compressor status display

•Pump operating condition display

**6.** Displays the run and stop status of the pump.

ON/OFF pump status display

• Tank fluid level

**7.** Displays the tank fluid level in three levels: "sufficient," "low," and "insufficient."

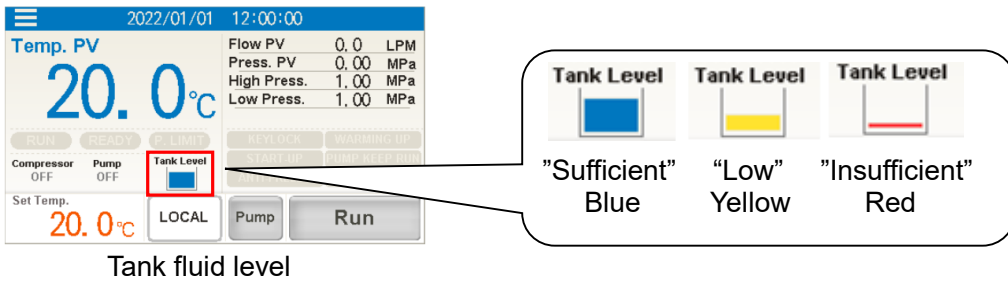

Tank fluid level

• Circulating fluid flow rate Circulating fluid flow rate

**8.** Displays the fluid flow rate.

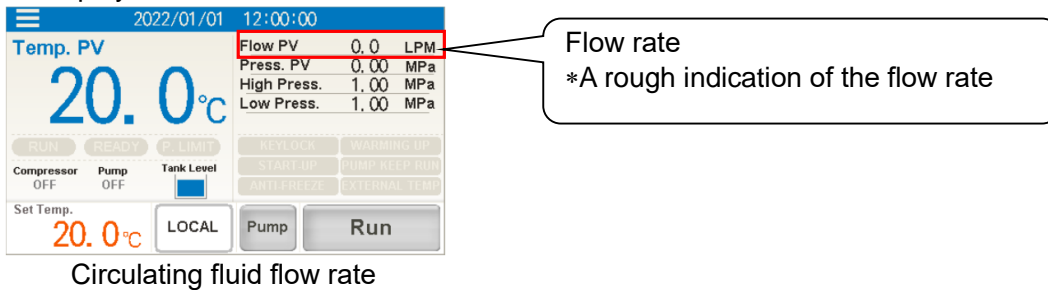

Circulating fluid flow rate

• Circulating fluid discharge pressure Press PV

**9.** Displays the discharge pressure.

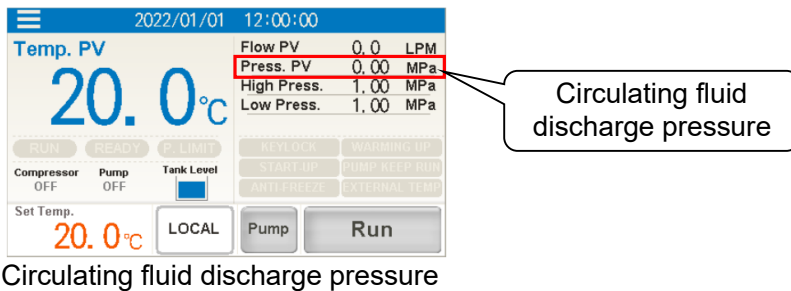

Circulating fluid discharge pressure

• Compressor circuit High pressure side High Press.

**10.** Displays the High pressure side of refrigeration circuit.

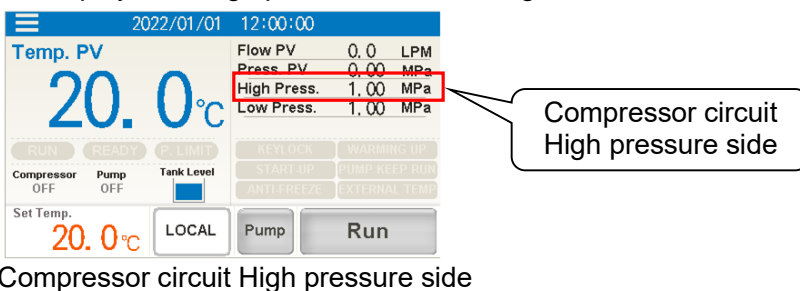

Compressor circuit High pressure side

•Compressor circuit Low pressure side Low Press

**11.**Displays the Low pressure side of refrigeration circuit.

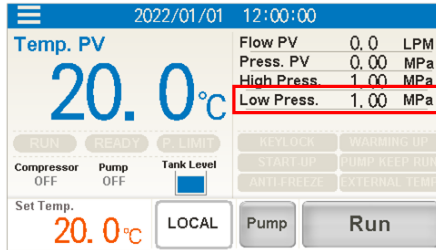

Compressor circuit Low pressure side

Compressor circuit Low pressure side

•Circulating fluid electrical conductivity DI PV

**12.**Displays the electric conductivity of the circulating fluid.

In the case of option D "With electrical conductivity control", to display the value.

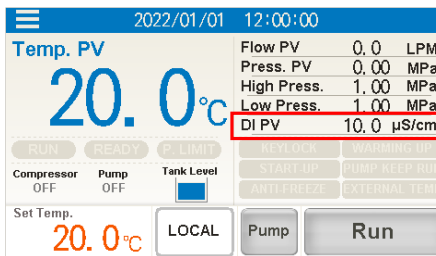

Electric conductivity of the circulating fluid

Electric conductivity

•Key lock condition display KEYLOCK

**13.**Displays the status of key lock settings

[ **KEYLOCK** ] lights up when KEY-LOCK setting is ON. (Refer to “KEY-LOCK, START-UP operating method, ANTI-FREEZING and WARMING-UP”(P.5-42) for the setting of KEY-LOCK.)

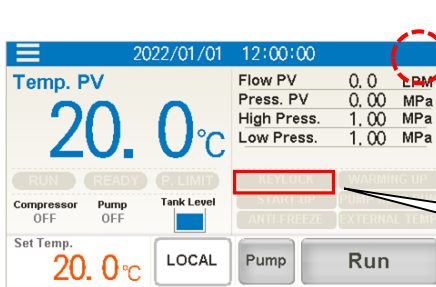

KEY-LOCK setting is ON

Key lock condition display

**KEYLOCK** KEY-LOCK setting is ON

KEYLOCK KEY-LOCK setting is OFF

• Startup operation status display START UP

**14.** Displays the status of operation settings at startup

[ **START-UP** ] lights up when START-UP setting is AUTO.  
 (Refer to “KEY-LOCK, START-UP operating method, ANTI-FREEZING and WARMING-UP”(P.5-42) for the setting of START-UP.)

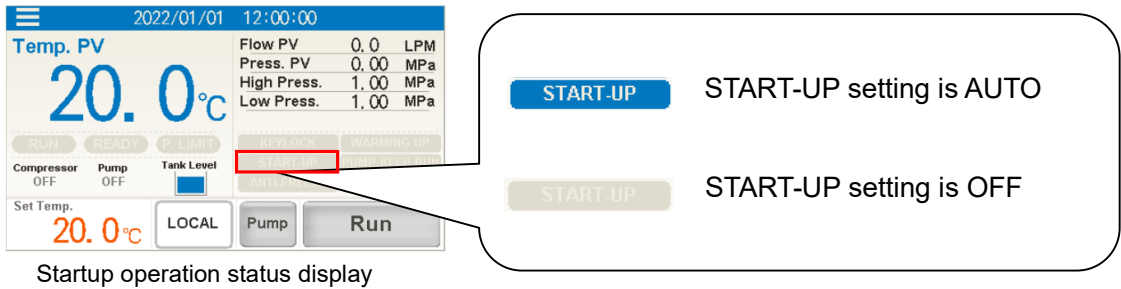

Startup operation status display

• Anti-freezing status display ANTI-FREEZE

**15.** Displays the status of ANTI-FREEZING settings.

[ **ANTI-FREEZE** ] lights up when ANTI-FREEZING settings is ON.  
 (Refer to “KEY-LOCK, START-UP operating method, ANTI-FREEZING and WARMING-UP”(P.5-42) for the setting of ANTI-FREEZING.)

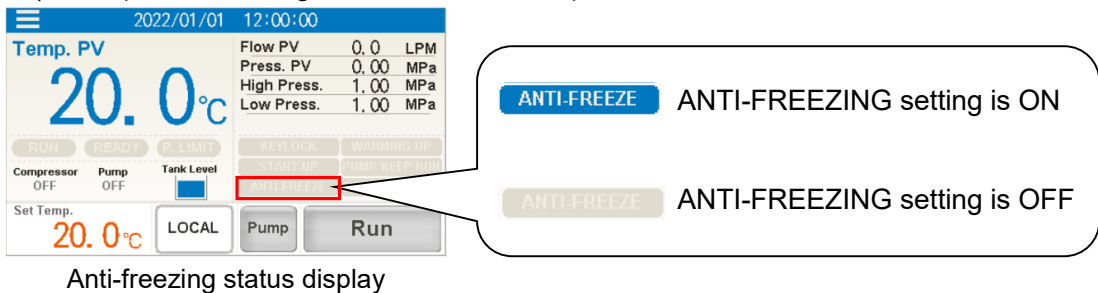

Anti-freezing status display

• Warming up status display WARMING UP

**16.** Displays the status of warm-up settings.

[ **WARMING UP** ] lights up when WARMING-UP setting is ON.  
 (Refer to “KEY-LOCK, START-UP operating method, ANTI-FREEZING and WARMING-UP”(P.5-42) for the setting of warm-up.)

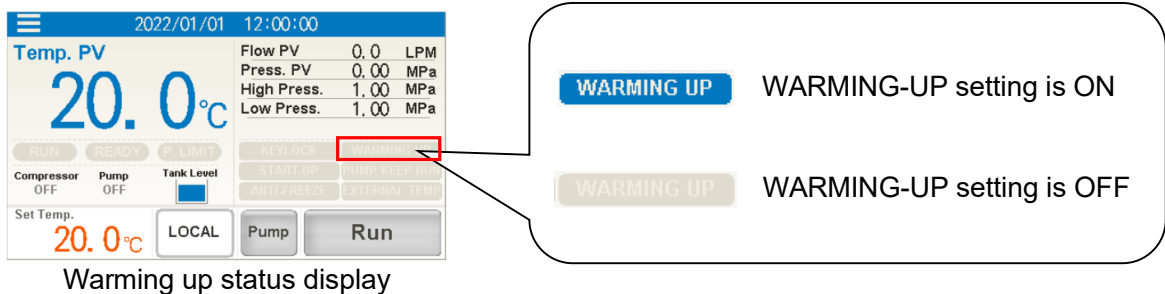

Warming up status display



•Pump operation continuation status display PUMP KEEP RUN

17. Displays the status of pump operation continuation setting.

[ PUMP KEEP RUN ] lights up when the pump operation continuation setting is enabled. (Refer to “KEY-LOCK, START-UP operating method, ANTI-FREEZING and WARMING-UP”(P.5-42) for the setting of the status of pump operation continuation.)

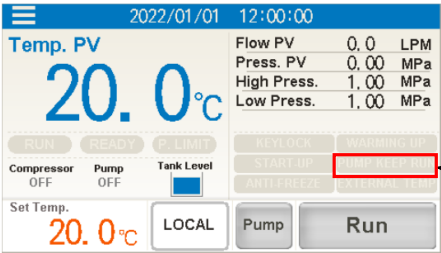

**PUMP KEEP RUN** PUMP KEEP RUN setting is enabled

**PUMP KEEP RUN** PUMP KEEP RUN setting is disabled

Pump operation continuation status display

•Circulating fluid set temperature SP

18. Displays the set temperature.

Touch the value in orange to display numeric keys to enter a value. Enter a set value.

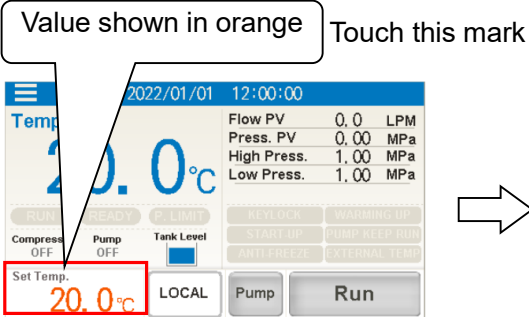

Example of an orange “Value”

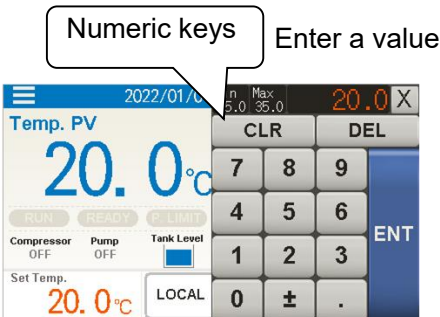

Example of numeric keys

The set temperature ranges are as follows:

Item	Circulating fluid temperature SP
Setting range	5°C to 35°C
By default	20°C

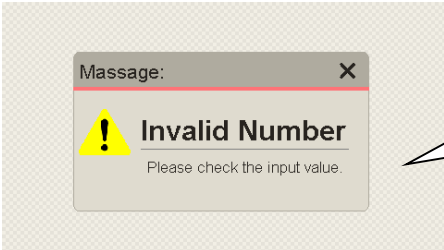

In the case of out of the setting range, and displays an error message.

Set temperature error

•Operation mode MODE

### 19. Display the current run mode

Set the operation mode.

[ LOCAL ] mode is set by default.

Operation mode can be selected from the following three modes:

- [ LOCAL ] mode: The operation is performed by the touch panel.
- [ DIO ] mode: The operation is performed by contact input signal.  
 (Refer to “5.4.9 Communication setting screen” for the setting of contact input signal)
- [ SERIAL ] mode: The operation is performed by the serial communication RS-232C/RS-485.(Refer to “5.4.9 Communication setting screen”. for Modbus/TCP communication.)

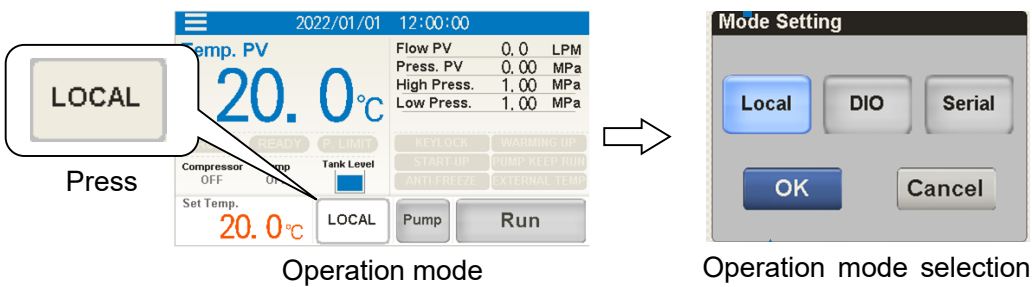





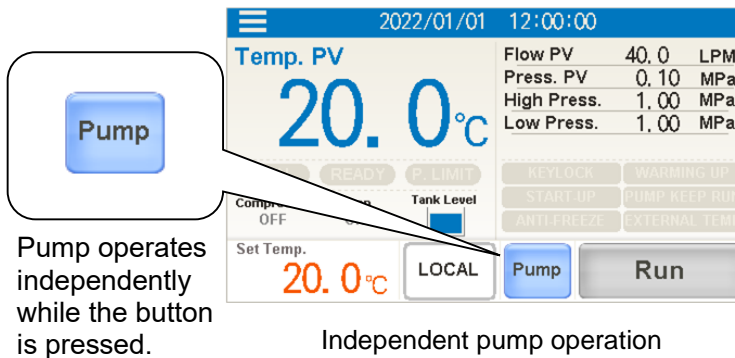

•Independent pump operation Pump

### 20. [ Pump ] Pump operates independently while the button is pressed.

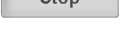
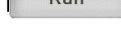

•Run/stop operation

**21.** Run/Stop the product. Press [  ] button when the product has stopped running to display “Operation check screen”. Press [  ] button to start operation. The [  ] button switches to the  button as soon as operation starts. Press [  ] button when the product is running to display “Stop check screen”. Press [  ] button to stop the operation. The [  ] button switches to the  button as soon as operation stopped.

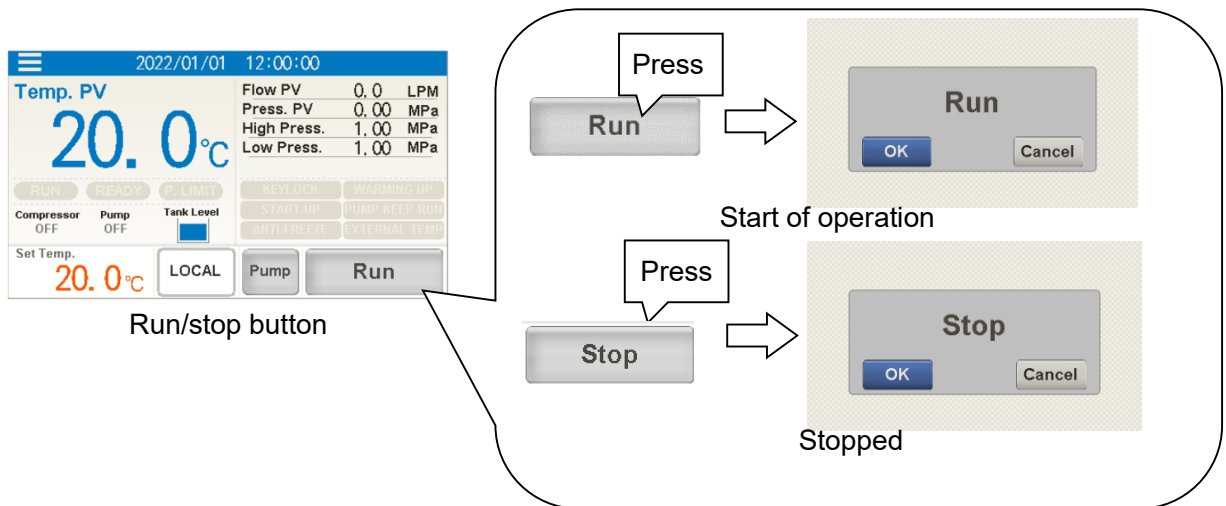

**[Tips]**

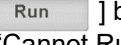
- If [  ] button is pressed when “Run/Stop (FLT)” alarm is activated, the “Cannot Run” message appears. Please turn off the alarm. Refer to “Chapter 6 Alarm Notifications and Troubleshooting” for turning off the alarm.
- If the “Operation mode” is set to anything other than “LOCAL”, a “Switch to the local mode” message appears. Set the running mode to the “LOCAL” mode.



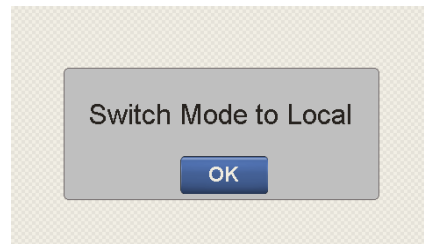

Cannot run because of the fault alarm



Switch to the local mode

### 5.4.2 Menu

[  ] (menu) key is located upper left on the applicable screen. Touch [  ] key to display the menu. Go to the applicable setting screen from the menu. The menu is closed when [  ] key is touched while the menu is displayed.

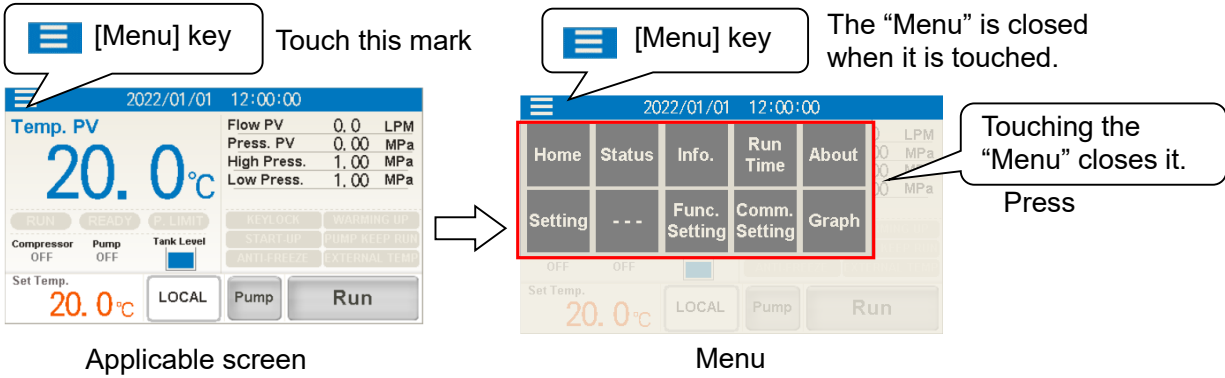

### 5.4.3 Status screen

Press [  ] button on the menu to display "Status" screen. The screen display of the "Status" screen is shown in "Table 5.4-2 Screen display of status screen".

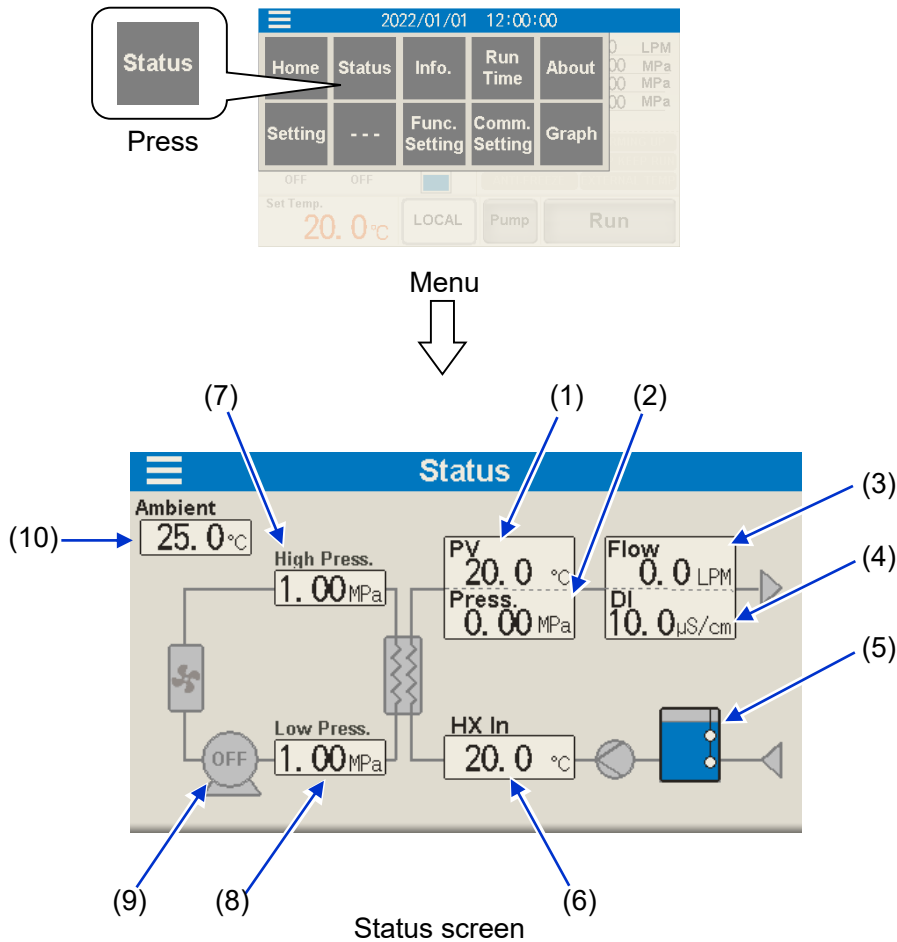
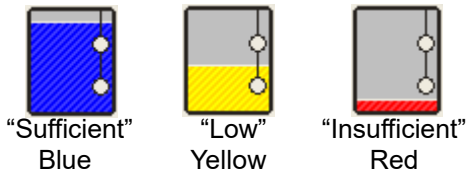

Table 5.4-2 Screen display of status screen

No.	Item	Explanation
(1)	Current circulating fluid temperature	Displays the current temperature of the circulating fluid outlet port.
(2)	Circulating fluid discharge pressure	Displays the circulating fluid *discharge pressure.
(3)	Circulating fluid flow rate	Displays the circulating fluid flow rate. *A rough indication of the flow rate.
(4)	Electrical conductivity *1	Displays the electrical conductivity of the circulating fluid.
(5)	Tank fluid level	Indicates the tank fluid level with three levels: "Sufficient," "Low," or "Insufficient."  
(6)	Heat exchanger inlet temperature	Displays the inlet temperature of the heat exchanger for the circulating fluid.
(7)	Pressure gauge on high-pressure side of compressor circuit	Displays the pressure gauge on high-pressure side of refrigerant circuit.
(8)	Pressure gauge on low-pressure side of the compressor circuit	Displays the pressure gauge on low-pressure side of the refrigerant circuit.
(9)	Compressor operating condition	Displays the compressor operating condition.
(10)	Ambient temperature	Displays the ambient temperature of the product.

\*1 In the case of option D "With electrical conductivity control", to display the value.

### 5.4.4 Information screen

Information screen is displayed when [ Info. ] button on the menu is pressed.

The "Information" screen has the following functions:

- To show the content of currently activated "Alarms".
- Displays the content of currently issued "Maintenance reminders".  
(Refer to "5.4.5 Check operation time screen and maintenance reminder" for details.)
- To reset an alarm. (An alarm cannot be reset without first eliminating the cause. Refer to "Chapter 6 Alarm Notifications and Troubleshooting" for details.)
- To display previously activated alarms (alarm history).

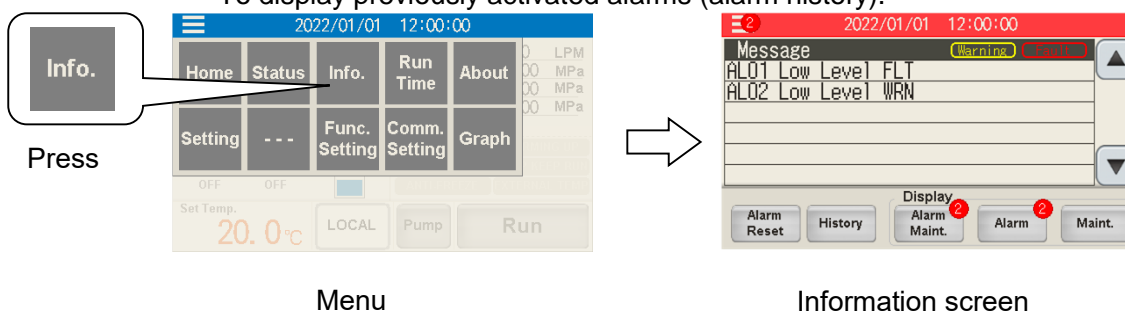

**[Tips]**

If an "Alarm" is activated when the product is operating, the screen automatically switches to the "Information". However, if the "Maintenance reminder" is issued, the screen will not switch. [  ] is displayed upper right on the screen if an "Alarm" is activated or a "Maintenance reminder" is issued. The number shows the number of activated "Alarms" or issued "Maintenance reminders"

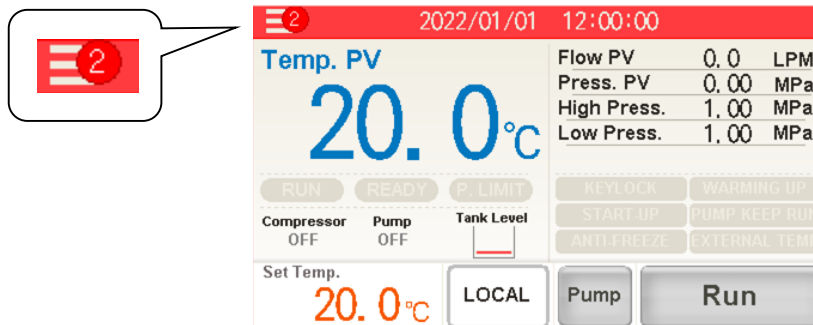

Display when an "Alarm" is activated or "Maintenance reminder" is issued

•Alarm reset

1. After eliminating the cause of the alarm, press [ Alarm Reset ] button to cancel the alarm. When the alarm is turned off, alarm names disappear from the "Information" screen.

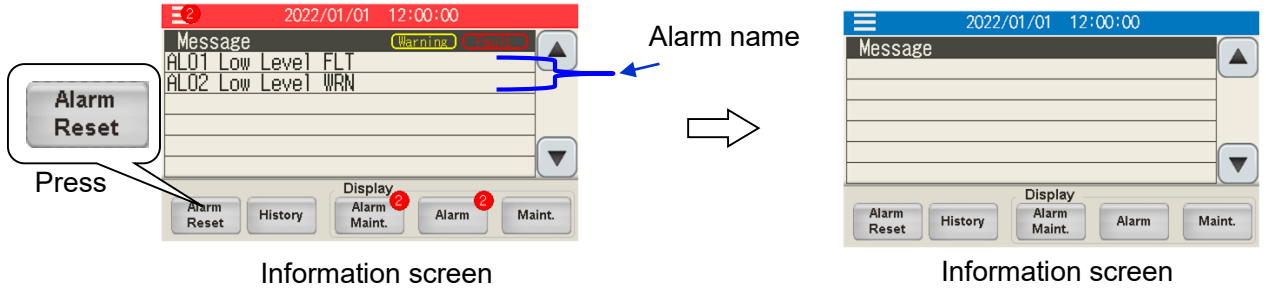

•Alarm name

2. Touch the "Alarm" on the "Information" screen to display details of the alarm. Touching alarm one time displays the alarm information. Touching alarm twice displays alarm information details. If the alarm utilizes a sub-code, this is displayed in the alarm information details.

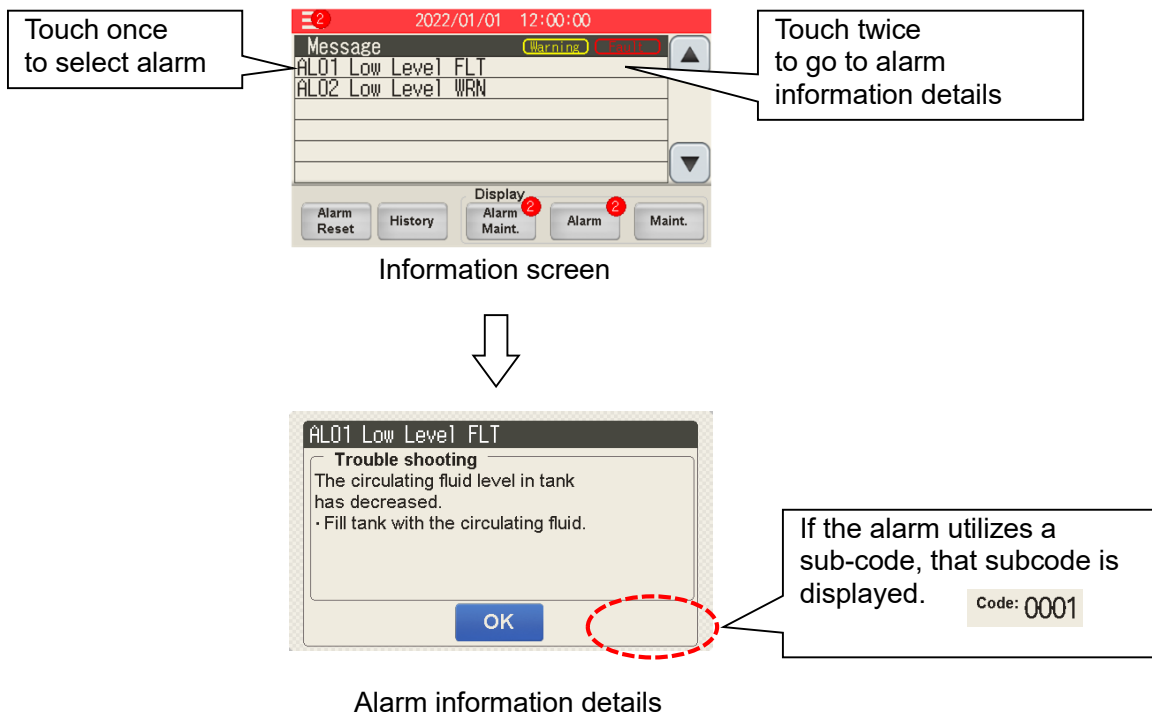

• Alarm log record

**3.** Previously activated “Alarm contents” are displayed if [ History ] button is pressed. A maximum of 300 records can be displayed. The date and time of an alarm is displayed if the alarm is touched on the “Alarm history” screen. A subcode is displayed when an alarm with a subcode is touched twice.

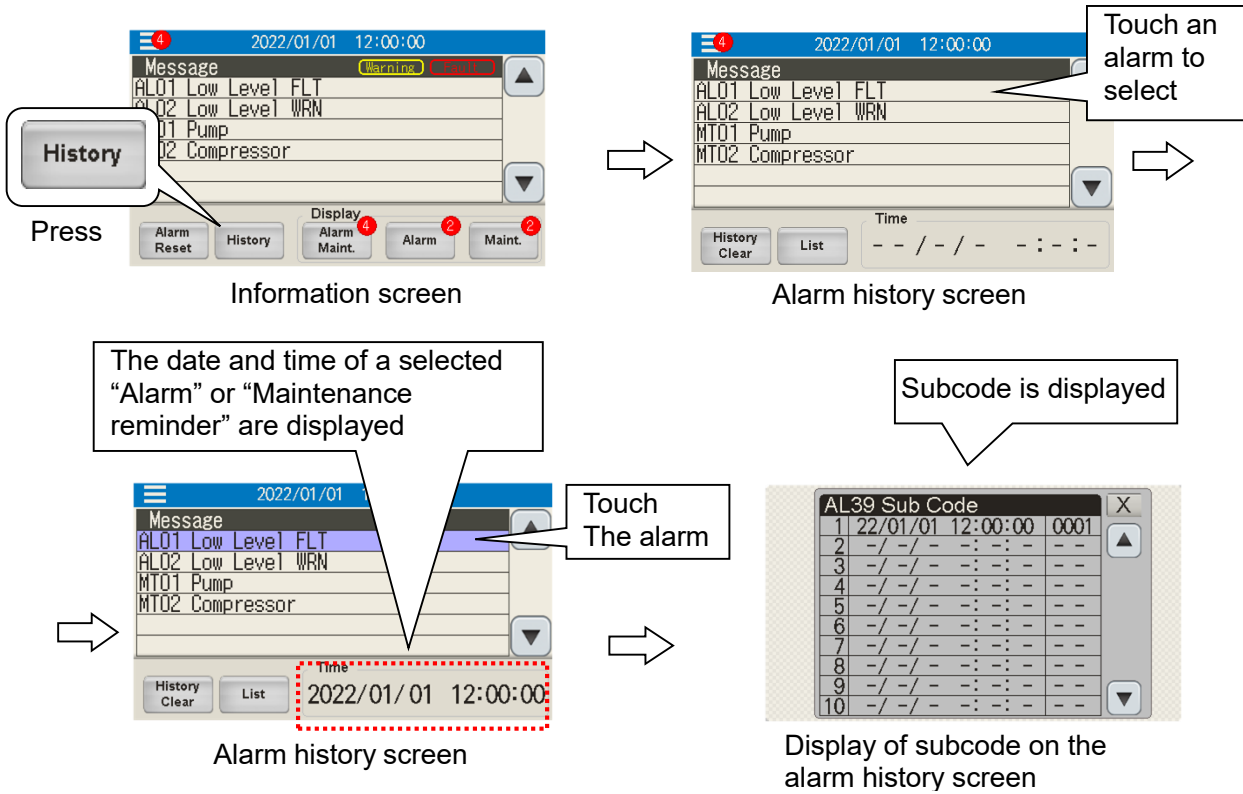

• Cleaning of alarm history

**4.** All “Alarm” records are cleared if the “History Clear” button is pressed. However, the currently activated alarm is not cleared.

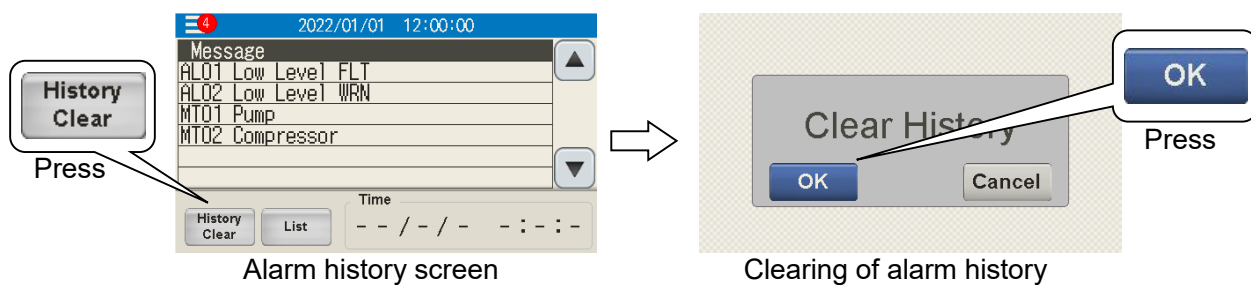



•Display of alarm/maintenance reminder

**5.** The “Alarm” and “Maintenance reminder” on the “Information” screen can each be individually displayed.

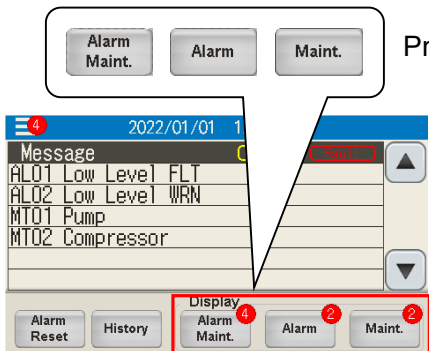

Information screen

Press

Button	Description
[ Alarm Maint. ]	Displays both alarm and maintenance reminder.
[ Alarm ]	Displays alarm only.
[ Maint. ]	Displays maintenance reminder only.

By default: It is set to “Alarm Maint.”

### 5.4.5 Check operation time screen and maintenance reminder

The “Check operation time” screen is displayed if [ Run Time ] button on the menu is pressed.

Screen display and function of the “Check operation time” screen are shown in “Table 5.4-3 Screen display of check operation time screen”.

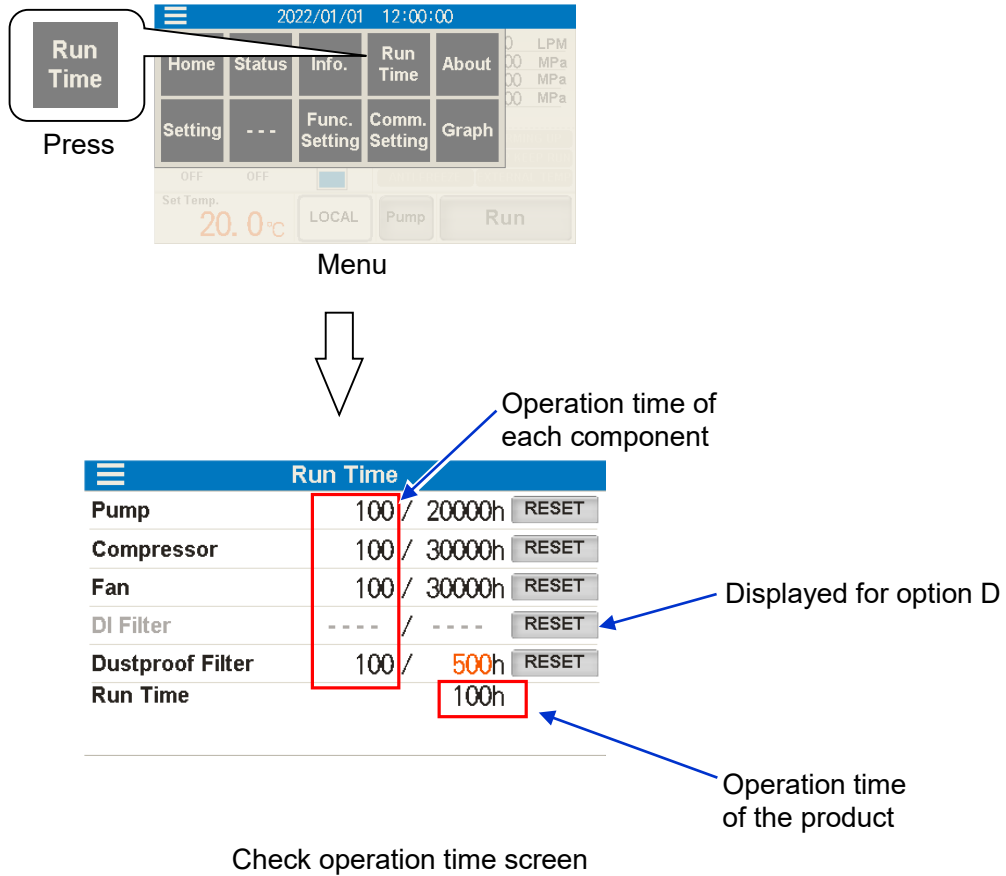

Table 5.4-3 Screen display of check operation time screen

No.	Indication	Item/replacement cycle	Explanation
1	Pump	Operating time	Displays the operating time for pump.
		20000 hour	Displays the recommended replacement cycle for pump.
2	Compressor	Operating time	Displays the operating time for compressor.
		30000 hour	Displays the recommended replacement cycle for a compressor.
3	Fan	Operating time	Displays the operating time of a fan.
		30000 hour	Displays the recommended replacement cycle for a fan.
4	DI Filter *1	Operating time	Displays the usage time of a DI filter.
		1 to 9999 hour By default: 500 hour	The "Maintenance reminder" is issued if the usage time has reached the hours specified by the user.
5	Dustproof Filter	Usage time	Displays the usage time of a dustproof filter.
		1 to 9999 hour By default: 500 hour	The "Maintenance reminder" is issued if the usage time has reached the hours specified by the user.
6	Run Time	Operating time	Displays the operation time of a chiller.
7	Reset	[ RESET ] button	The operation time is reset to "0 hour" when [ RESET ] button is pressed.

\*1 In the case of option D "With electrical conductivity control", to display the value.

#### ■About "Maintenance reminder" function

- "Maintenance reminder" is displayed on the "Information" screen if a product part in use has reached its recommended replacement cycle.
- "Maintenance reminder" is always issued if a part of the product has reached the recommended replacement cycle.
- A "Maintenance reminder" signal can be output by contact signal and by serial communication. Communication setting screen (Refer to "5.4.9 Communication setting screen" for details.)
- A "Maintenance reminder" signal can be output as "The AL36: Maintenance alarm". (Refer to "5.4.8 Ambient temperature alarm [AL35] and Maintenance Alarm [AL36]".)

• Setting the usage time of DI filter

1. The replacement period (usage time) for a DI filter can be set. “Maintenance reminder” is always issued when the filter reaches the specified time. Touch the numeric section of DI filter to set the time of use. Setting range: 1 to 9999 hours (by default: 500 hours)

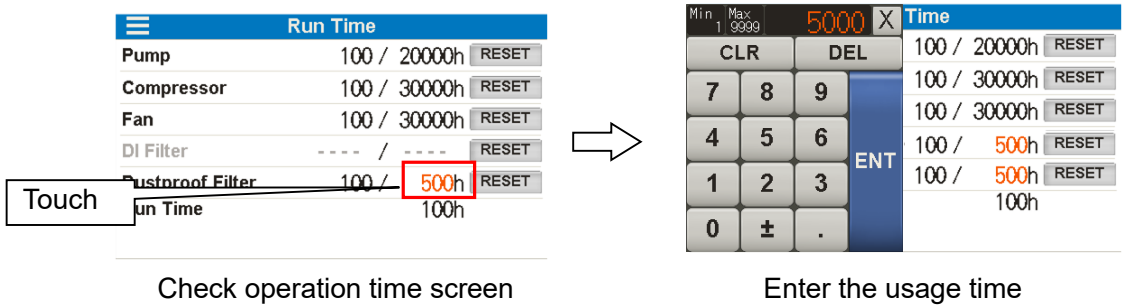

\*In the case of option D "With electrical conductivity control", it can be set.

• Setting of the usage time of dustproof filter

2. The replacement period (usage time) for a dustproof filter can be set. “Maintenance reminder” is always issued when the filter reaches the specified time. Touch the numeric

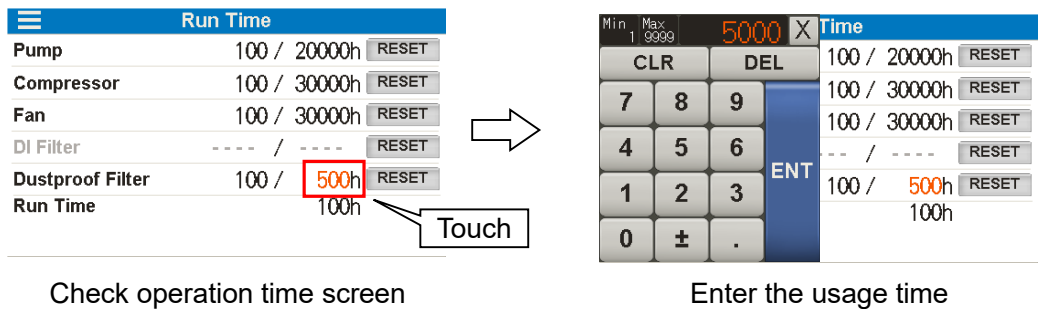

### 5.4.6 Software version screen

“Software version” screen is displayed if [ **About** ] button on the menu is pressed. The software number and version number are displayed.

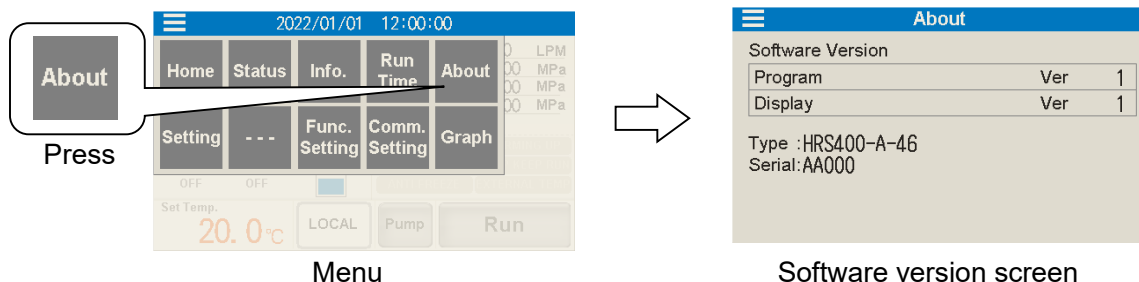

### 5.4.7 Setting screen

A screen for shifting to the following setting screens is displayed if [ **Setting** ] button on the menu is pressed.

- Setting screen for temperature rise/drop alarm (AL10/AL11)
- Setting screen for TEMP READY alarm (AL12) of TEMP READY function
- Setting screen for TEMP OFFSET
- Setting screen for pump operation mode
- Setting screen for discharge pressure alarm (AL18/AL19/AL20)
- Setting screen for electric conductivity (AL28)

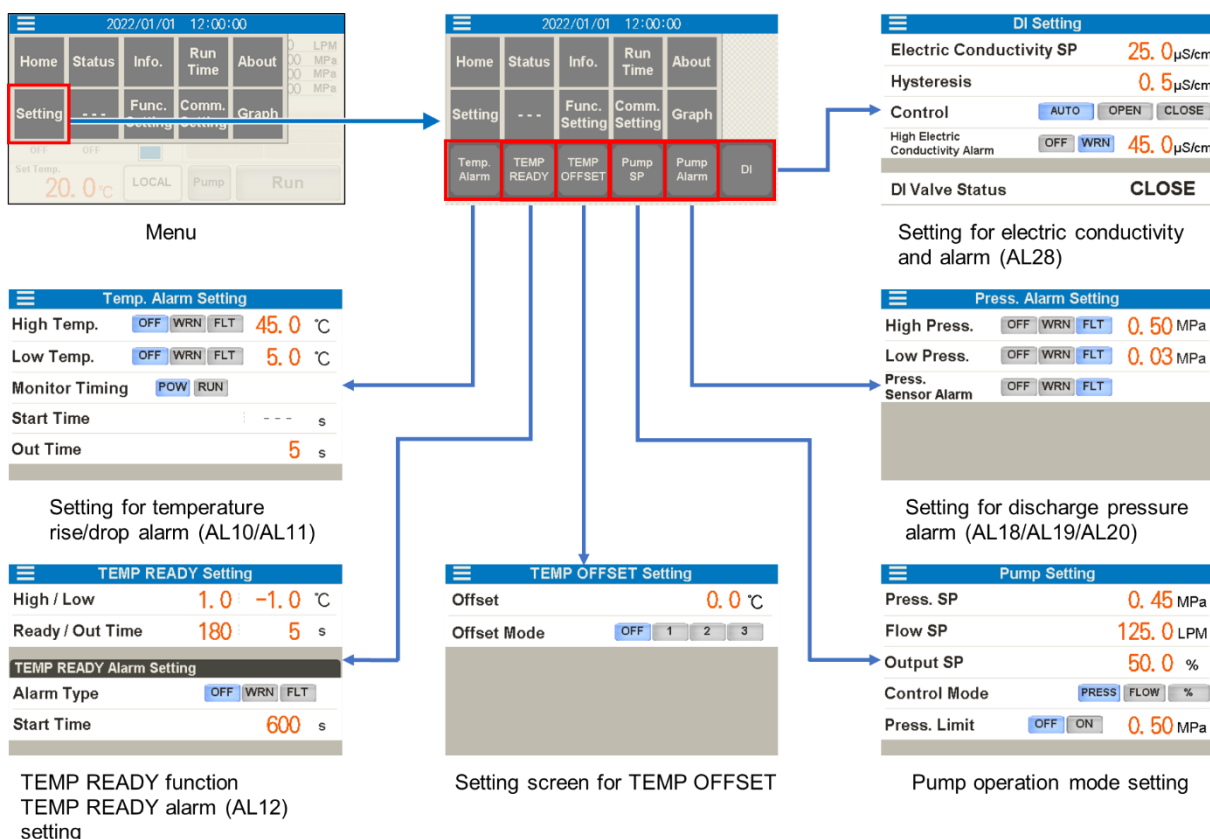

•Temperature rise/drop alarm (AL10/AL11)

**1.** An alarm can be activated when the current temperature of circulating fluid rises/drops outside of the setting range.

This function is OFF (deactivated) by default.

The following two types of alarm can be set on the “Temperature rise/drop alarm setting” screen:

- AL10: Alarm for circulating fluid temperature rise—the alarm activates if the temperature rises above the set temperature.
- AL11: Alarm for circulating fluid temperature drop—the alarm activates if the temperature drops below the set temperature.

Following settings can also be selected: Refer to “Table 5.4-4 Settings of AL10/AL11”.

- Operation of the product at the time of alarm
- Conditions to start alarm monitoring
- Start time for alarm monitoring

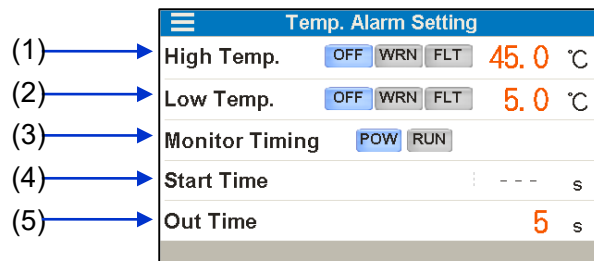

Setting for temperature rise/drop alarm (AL10/AL11)

Table 5.4-4 Settings of AL10/AL11

No.	Indication	Item	Setting and selection		Setting range
(1)	High Temp.	AL10 : Circulating fluid temperature rise	<input type="button" value="OFF"/> *	Disabled	5 to 55°C * 45°C
			<input type="button" value="WRN"/>	Operation continues during the alarm	
			<input type="button" value="FLT"/>	Operation stops during alarm	
(2)	Low Temp.	AL11 : Circulating fluid temperature drop	<input type="button" value="OFF"/> *	Disabled	1 to 35°C * 5°C
			<input type="button" value="WRN"/>	Operation continues during the alarm	
			<input type="button" value="FLT"/>	Operation stops during alarm	
(3)	Monitor Timing	Alarm monitoring conditions	<input type="button" value="POW"/> *	Continuous monitoring (monitoring continues even when the operation is stopped)	—
			<input type="button" value="RUN"/>	Monitoring continues only during operation. If [ <input type="button" value="RUN"/> ] is selected, [ <input type="button" value="OFF"/> ] or [ <input type="button" value="AUTO"/> ] should be selected. Refer to “■ About alarm monitoring timing” (P.5–29) for details.	—
(4)	Start Time	No monitoring Time	[Start Time]	Alarm monitoring starts when the set time has passed after the start of operation.	0 to 9999sec * 600sec
(5)	Out Time	Out time	[Out Time]	The alarm is activated when the set time has passed after the temperature rises/drops out of the alarm setting range.	0 to 600sec * 5sec

\*By default.

■ About alarm monitoring timing

If [ RUN ] is selected as (3) "Monitor Timing" alarm monitoring condition, [ OFF ] and [ AUTO ] can be additionally selected. [ AUTO ] is a function to start alarm monitoring when the circulating fluid temperature rises/drops within the alarm setting temperature range in the time period specified by (4) "Start Time" (no monitoring time). Specific alarm monitoring timing is shown in "Figure 5-5 Alarm monitoring timing".

[Example of setting]

- Circulating fluid SP: 20°C
- (1) "High Temp." Circulating fluid temperature rise (AL10): 22°C
- (2) "Low Temp." Circulating fluid temperature drop (AL11): 18°C
- (3) "Monitor Timing" Alarm monitoring conditions: [ RUN ] and [ AUTO ]
- (4) "Start Time" No monitoring time: 1200 sec / "Out Time" : 600 sec

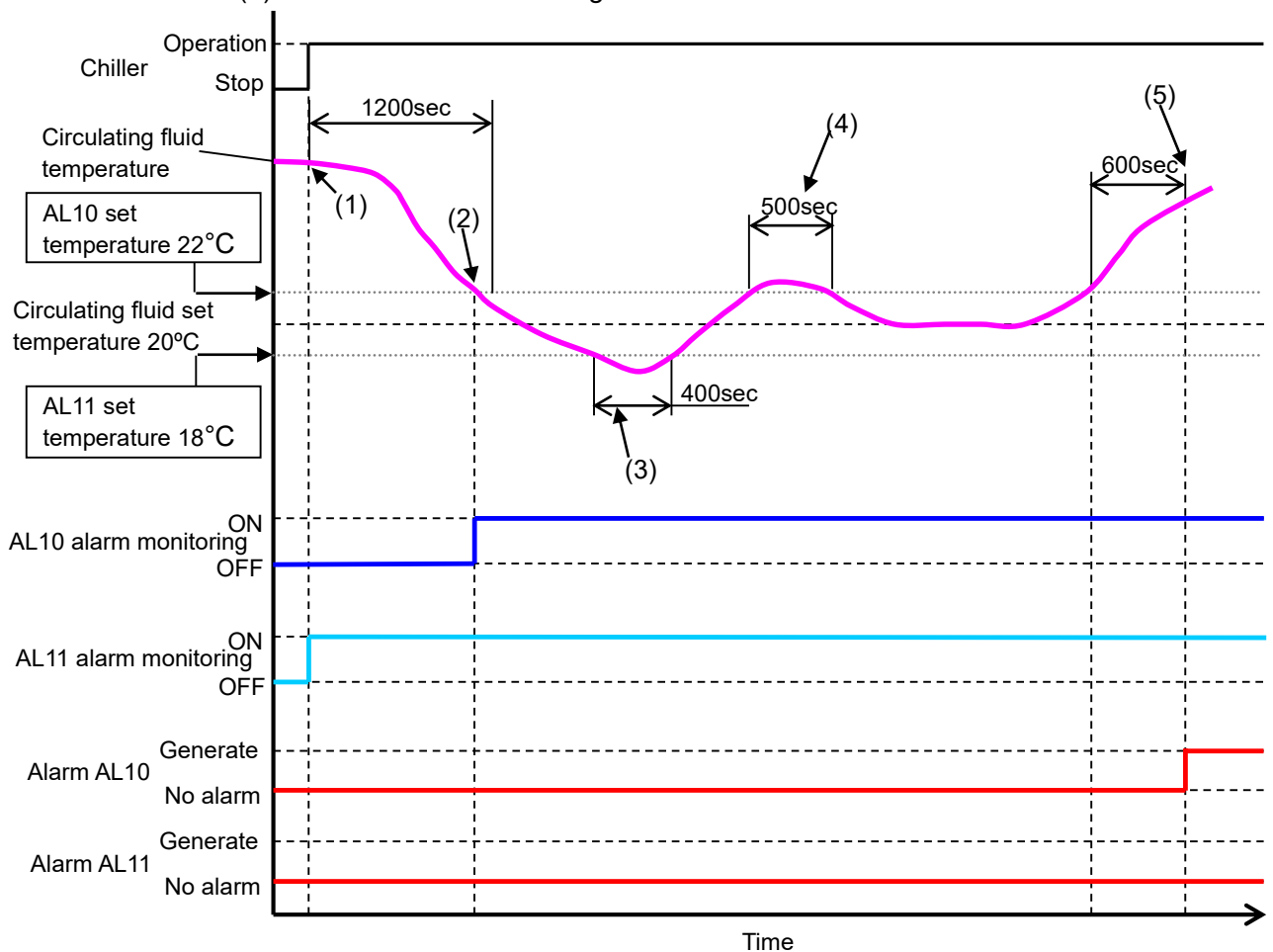

Fig. 5-5 Alarm monitoring timing

- Status (1): Start operation of the chiller. Monitoring of "AL11" starts since the temperature is 18°C or higher which is the value set for "AL11."
- Status (2): Monitoring of "AL10" starts since the temperature falls below 22°C, which is the value set for "AL10."
- Status (3): No alarm is activated since the temperature returns to the range within "Out Time" 600 seconds even though it is below 18°C, which is the value set for "AL11."
- Status (4): No alarm is activated since the temperature returns to the range within "Out Time" 600 seconds even though it is above 22°C, which is the value set for "AL10."
- Status (5): "AL10" is activated 600 seconds after the temperature rises above 22°C, which is the value set for "AL10."

•TEMP READY alarm (AL12) of TEMP READY function

**2.** "TEMP READY" signal can be output by signal contact and serial communication if the circulating fluid temperature is within the range set for the time and temperature. "TEMP READY" signal cannot be "Disabled".

[ **Ready** ] is displayed on the "Home" screen if "TEMP READY" conditions are met. (Refer to "5.4.1 Home screen Operation condition display")

The alarm "AL12: TEMP READY alarm" can be output if the temperature does not meet the TEMP READY conditions. This function is OFF (deactivated) by default.

It can be set on "TEMP READY function setting" screen.



Refer to "Table 5.4-5 TEMP READY signal setting (P.5-31) and "■About TEMP READY function" (P.5-32) for details.

TEMP READY Setting	
(1) →	High / Low      1.0 : -1.0 °C
(2) →	Ready / Out Time      180 : 5 s
TEMP READY Alarm Setting	
(3) →	Alarm Type      OFF WRN FLT
(4) →	Start Time      600 s

TEMP READY signal (AL12) setting



Table 5.4-5 TEMP READY signal setting

No.	Indication	Item	Setting and selection		Setting range
(1)	High/ Low	Upper/lower temperature limit	[High]	Sets the upper temperature limit for circulating fluid SP.	+0.1 °C to +10.0 °C * +1.0 °C
			[Low]	Sets the lower temperature limit for circulating fluid SP.	-0.1 °C to -10.0 °C * -1.0 °C
(2)	Ready/ Out Time	Stable temperature time/out time	[Ready Time]	“TEMP READY” signal is output when the set time has passed after the circulating fluid temperature rises/drops within the range of (1) “Upper/Lower temperature limit.”	10sec to 9999sec * 180sec
			[Out Time]	“TEMP READY” is cleared when the set time has passed after the circulating fluid temperature rises/drops outside the range of (1) “Upper/Lower temperature limit” in the “TEMP READY” condition.	0sec to 600sec * 5sec
(3)	Alarm Type	AL12 alarm operation	 *	Disabled	—
				Operation continues during the alarm	—
				Operation stops during alarm	—
(4)	Start Time	Start time of AL12 alarm monitoring	[Start Time]	Monitoring of “AL12: TEMP READY alarm” starts when the set time has passed after the start of operation.	0sec to 9999sec * 600sec

\* By default.

■ About TEMP READY function

The operation chart of “TEMP READY” signal is shown in Fig. 5-6 TEMP READY signal chart.

[Example of setting]

- (1) “High” Upper temperature limit: +2°C and “Low” Lower temperature limit: -2°C
- (2) “Ready Time” Stable temperature time: 300 sec and “Out Time” extra temperature time: 200 sec
- (3) “Alarm Type” Alarm operation (AL12): “WRN”
- (4) “Start Time” Start time of alarm monitoring (AL12): 1000 sec

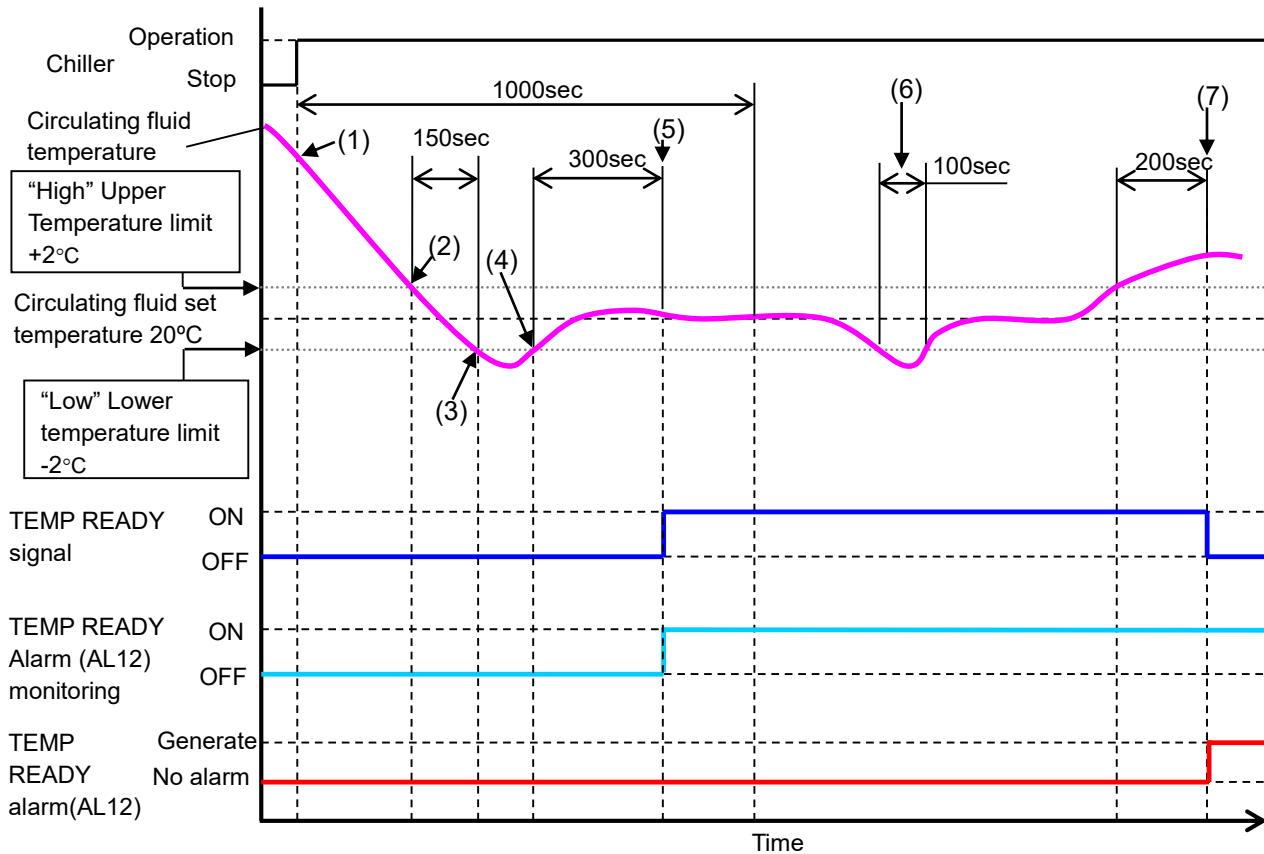

Fig.5-6 TEMP READY signal chart

- Status (1): Start operation of the chiller.
- Status (2): The temperature is in the "High/Low" range, but no “TEMP READY” signal is generated since “Ready Time” is set at 300 sec at this point.
- Status (3): The 300 sec count for “Ready Time” is reset since the temperature is now outside of the “Low” range.
- Status (4): The 300 sec count for “Ready Time” starts since the temperature is now within the “High/Low” range.
- Status (5): “TEMP READY” signal is generated at this point since the temperature remains in the “High/Low” range for 300 sec of “Ready Time.”  
Monitoring of “TEMP READY alarm (AL12)” starts at this point where 1000 sec of “Start Time” has elapsed.
- Status (6): “TEMP READY” signal output continues since the temperature is now back within the “Out Time” range of 200 sec even though it was temporarily outside the “Low” range.
- Status (7): “TEMP READY” signal turns OFF when 200 sec has passed after the temperature rises above the “High” range. “TEMP READY alarm (AL12)” is simultaneously activated.

•Offset (TEMP OFFSET) function

**3.** The circulating fluid temperature can be offset. Refer to “■ About offset function” (P.5-33) for details.

This function can be set on “Offset setting” screen.  
Refer to Table 5.4-6 Offset setting for details.

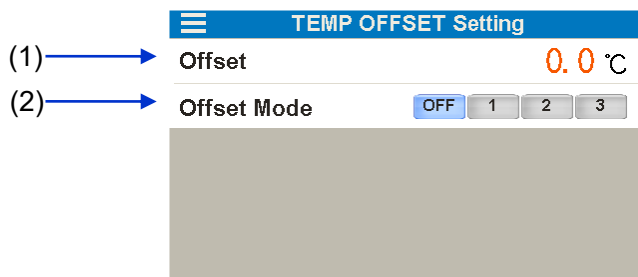

Offset setting

Table 5.4-6 Offset setting

No.	Indication	Item	Explanation	Setting range
(1)	Offset Temp.	Offset temperature	Sets offset temperature.	-20.0 °C to +20.0 °C [By default] 0.0 °C
(2)	Offset Mode	Offset mode	Selects the offset mode.	OFF / 1 / 2 / 3 [By default] OFF
			[ OFF ] Disabled	
			[ 1 ] MODE 1	
			[ 2 ] MODE 2	
			[ 3 ] MODE 3	

■ About offset function

This function controls the circulating fluid discharge temperature with offset.

Temperature offset may occur between the thermo-chiller and the customer’s device depending on the installation environment. To correct the temperature offset, three types of offset functions are available (MODE1 to 3). The default setting of this function is “OFF”.

**【When communication is used】**

The circulating fluid temperature sent by serial communication is the circulating fluid temperature which is displayed on the thermo-chiller (the circulating fluid temperature after offset).

●Example of temperature offset

The discharge temperature of the circulating fluid is 30°C, but the fluid temperature in the customer's device is 29°C because of heat radiation during sending of the fluid.

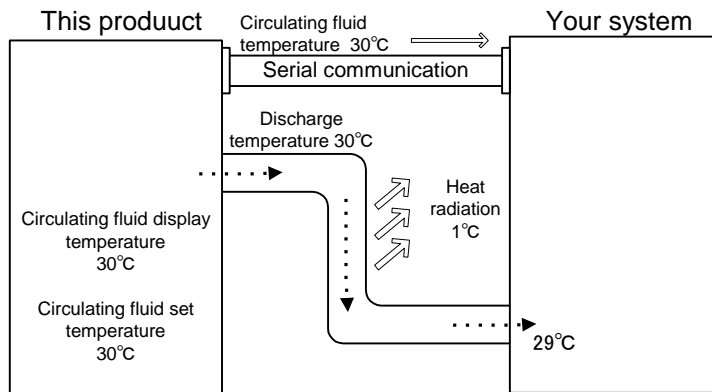

MODE	Explanation
MODE1	Control the temperature so that the discharge temperature of the circulating fluid is circulating fluid set temperature + offset temperature. Circulating fluid temperature indicates the circulating fluid discharge temperature.
MODE2	Control the temperature so that the discharge temperature of the circulating fluid is circulating fluid set temperature. Circulating fluid temperature indicates the circulating fluid discharge temperature + offset temperature.
MODE3	Control the temperature so that the discharge temperature of the circulating fluid is circulating fluid set temperature + offset temperature. Circulating fluid temperature indicates the circulating fluid discharge temperature - offset temperature.
OFF	Control the temperature so that the discharge temperature of the circulating fluid is circulating fluid temperature set value.

■Example of MODE 1

When the offset temperature is 1°C, the thermo-chiller controls the temperature at 31°C (circulating fluid set temperature + offset temperature.) Even if the discharge temperature is 31°C, the circulating fluid temperature is 30°C at the customer's device because of 1°C of heat radiation during sending of the fluid. Circulating fluid display temperature and communication data is 31°C.

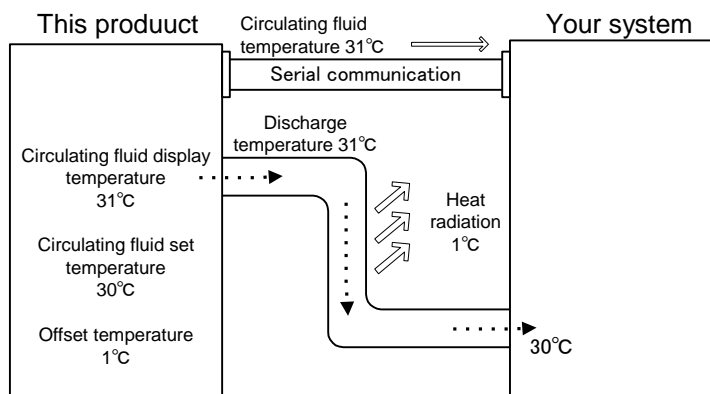

■Example of MODE 2

When the offset temperature is -1°C, circulating fluid display temperature and the communication data is 29°C (circulating fluid discharge temperature + offset temperature), and matches the circulating fluid temperature at the customer's device.

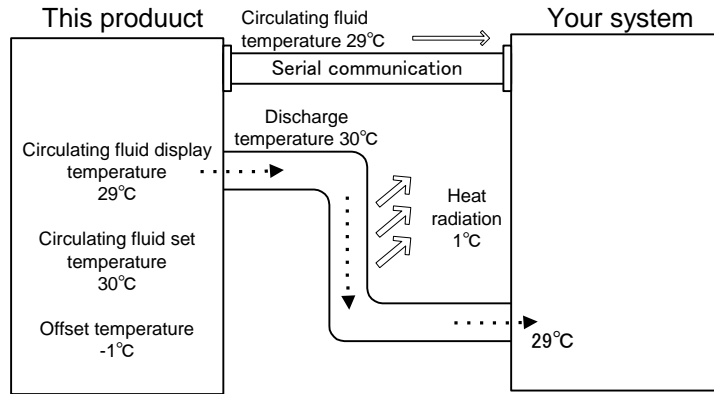

■Example of MODE 3

When the offset temperature is 1°C, the thermo-chiller controls the temperature at 31°C (circulating fluid set temperature + offset temperature) Even if the discharge temperature is 31°C, the circulating fluid temperature is 30°C at the customer's device because of 1°C of heat radiation during sending of the fluid. The circulating fluid display temperature and the communication data is 30°C (circulating fluid discharge temp. - offset temp.), and matches the circulating fluid temperature at the customer's device.

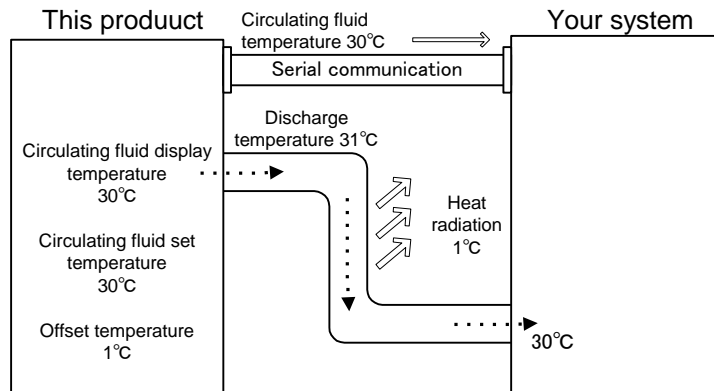

• Pump operation mode

**4.** Pump operation mode can be set up.

Pump operation mode can be selected from the following three modes:

- Pressure control mode—Operates to maintain the circulating fluid discharge pressure at the set pressure. This mode is set by default.

The pressure might not rise to the set pressure if the piping resistance in the user’s device and piping is too small.

- Flow control mode—Operates to maintain the circulating fluid flow rate at the set flow rate. (However, flow rate serves as a rough indication.)

The flow rate might not reach the set flow rate if the piping resistance in the user’s device and piping is too large.

- Pump output setting mode—Operates to maintain the pump output (rotation) at the set output.

■ About the control function of circulating fluid discharge pressure

This is a function to control the pump output to maintain the circulating fluid discharge pressure within the set pressure.

This function is “Disabled” by default. If this function is “Enabled”, the control pressure set by this function gets priority over the pressure, flow rate and output set by the pump operation mode.

[ **P. Limit** ] is displayed on the upper screen when the pump discharge pressure is controlled during operation.

(Refer to “5.4.1 Operation condition display on home screen”.)

This can be set on “Pump operation mode setting” screen.

Refer to “Table 5.4-7 Pump operation settings for details”.

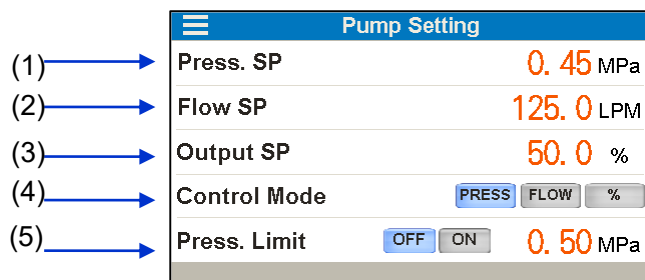

Table 5.4-7 Pump operation mode setting

No.	Indication	Item	Explanation	Setting range	
(1)	Press. SP	Set the pressure in the while in pressure control mode	(4) The pump operation is controlled to maintain the set pressure when “control mode” (operation mode) is set to “ <b>PRESS</b> ”.	HRS400	0.10 to 0.68MPa *0.45MPa
(2)	Flow SP	Set flow rate in the flow rate control mode	(4) The pump operation is controlled to maintain the set flow rate when “control mode” (operation mode) is set “ <b>FLOW</b> ”.	HRS400	40.0 to 180.0LPM *125.0LPM
(3)	Output SP	Set the output in the output setting mode	(4) The pump operation is controlled to maintain the set output (rotation) when “control mode” (operation mode) is set to “ <b>%</b> ”.	HRS400	50.0 to 100.0% *50.0%
(4)	Control Mode	Selection of pump operation mode	Selects the pump operation mode	—	—
			<b>PRESS</b> * Pressure control mode		
			<b>FLOW</b> Flow rate control mode		
		<b>%</b> Set output mode			
(5)	Press.Limit	Pressure setting for pressure control function	Selects enabling/disabling of the pressure control.	HRS400	0.10 to 0.68MPa *0.50MPa
			<b>OFF</b> * Function disabled		
			<b>ON</b> Function enabled		

\* By default

• Discharge pressure alarm (AL18/AL19/AL20)

- 5.** An alarm can be activated when the circulating fluid discharge pressure rises/drops outside the setting range. This function is set to “ [ **FLT** ] (stop) at the time of alarm” by default. The following two alarms can be set on “Discharge pressure alarm setting” screen:
- AL19: Alarm for circulating fluid discharge pressure rise—this alarm activates when the pressure rises above the set pressure.
  - AL20: Alarm for circulating fluid discharge pressure drop—this alarm activates when the pressure drops below the set pressure.
- Following settings can also be selected:
- Selection of product operation when an alarm occurs

The alarm “AL18: failure of circulating fluid discharge pressure sensor” activates when a failure is detected in the circulating fluid discharge pressure sensor. This allows selecting the product operation when the alarm “AL18” is activated. This function is set to “Operation stops at time of alarm” by default. If the operation at the time of the alarm “AL18” is set to become [ **OFF** ] (disabled) or [ **WRN** ] (operation continues at time of alarm), the pump operation mode switches to the “Pump output setting mode” (50% output) to continue operation when a pressure sensor failure is detected.

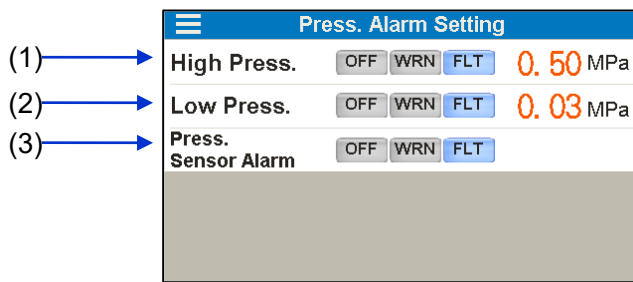

Setting of discharge pressure alarm (AL18/AL19/AL20)

Table 5.4-8 Settings for AL18/AL19/AL20

No.	Indication	Item	Setting and selection		Setting range
(1)	High Press.	AL19 : Circulating fluid discharge pressure rise	OFF	Disabled	0.03 to 0.68MPa * 0.50MPa
			WRN	Operation continues during the alarm	
			FLT *	Operation stops during alarm	
(2)	Low Press.	AL20 : Circulating fluid discharge pressure drop	OFF	Disabled	0.03 to 0.68MPa * 0.03MPa
			WRN	Operation continues during the alarm	
			FLT *	Operation stops during alarm	
(3)	Press. Sensor Alarm	AL18: Failure of circulating fluid discharge pressure sensor	OFF	Disabled	—
			WRN	Operation continues during the alarm	
			FLT *	Operation stops during alarm	

\* By default



• Electric conductivity and alarm setting (AL28)

**6.** Entering value settings for electrical conductivity of circulating fluid and hysteresis causes circulating fluid to flow from the solenoid valve through to the DI filter to control the electrical conductivity.

\* Only in the case of option D "With electrical conductivity control", it can be set.

The following items can be set on "Electrical conductivity and alarm (AL28) setting" screen:

- Target electric conductivity value
- Electric conductivity hysteresis
- Setting of solenoid valve operation during the operation of the product: "Control"/"Normally open"/"Normally closed".
- "Enabling"/"Disabling" of "AL28: Electric conductivity increase" alarm function

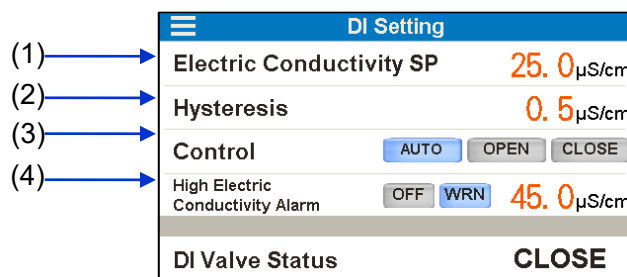

Electric conductivity and alarm (AL28) setting

Table 5.4-9 Settings of electric conductivity (AL28)

No.	Indication	Item	Explanation	Setting range	
(1)	Electric Conductivity SP	Target electric conductivity value	Sets a target electric conductivity value.	0.5 to 45.0μS/cm * 25.0μS/cm	
(2)	Hysteresis	Electric conductivity hysteresis	Sets an electric conductivity hysteresis. Refer to "■ About electric conductivity control" (P.5-40) for details.	0.1 to 10.0μS/cm * 0.5μS/cm	
(3)	Control	Solenoid valve operating method	<input type="button" value="AUTO"/> *	Controls the solenoid valve to achieve the target value.	-
			<input type="button" value="OPEN"/>	Normally open (remains open when product is stopped)	
			<input type="button" value="CLOSE"/>	Normally close	
(4)	High Electric Conductivity Alarm	AL28: Setting of Electrical conductivity increase alarm	"AL28" activates when electrical conductivity increases above the set value. This sets the setting value and operation when an alarm occurs. "AL28" automatically turns off the alarm when the electrical conductivity falls below the set value.		0.4 to 46.0μS/cm * 45.0μS/cm
			<input type="button" value="OFF"/>	Disabled	
			<input type="button" value="WRN"/> *	Operation continues during the alarm	

\* By default

■ About electric conductivity

An example of control of electrical conductivity control is shown in “Figure 5-7 Example of electrical conductivity control”.

Example operation of electric conductivity control

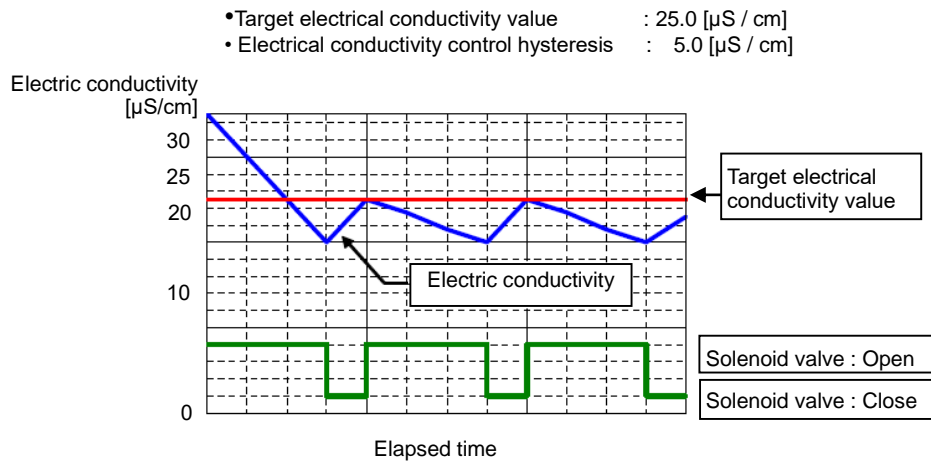
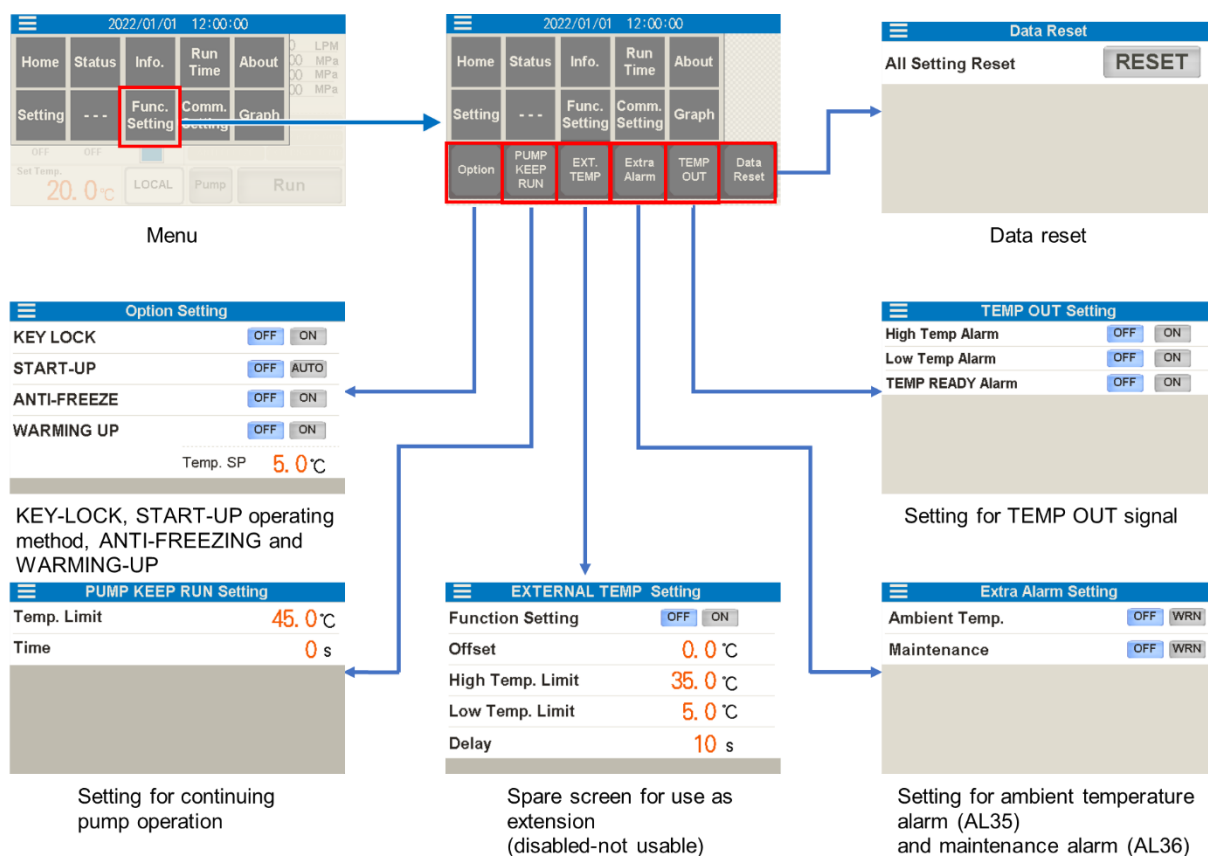

Fig.5-7 Example of electrical conductivity control

### 5.4.8 Function setting screen

A screen for shifting to the following setting screens is displayed if [ **Func. Setting** ] button on the menu is pressed.

- Setting screen of KEY-LOCK/START-UP operating method/ANTI-FREEZING/WARMING-UP
- Setting screen for continuing pump operation
- Setting screen for ambient temperature alarm (AL35) and maintenance alarm (AL36)
- Setting screen for TEMP OUT signal
- Setting screen for data reset



•KEY-LOCK, START-UP operating method, ANTI-FREEZING and WARMING-UP

- 1.** Following settings can be made on this product:
- KEY-LOCK————— Prevents all operations other than “Run/Stop,” Change screen” and “Alarm reset.”
  - START-UP operation setting— Function to restore back to the state prior to power shutdown, after the power supply is restored, when power supply had been cut off due to a power outage.
  - ANTI-FREEZING————— Function to prevent freezing of circulating fluid when the operation was stopped during winter time by automatic operation and by heating the circulating fluid with heat generated by pump. Pump automatic running and stopping is repeated to prevent freezing by maintaining circulating fluid temperature at 3°C to 5°C.
    - Pump automatically starts operating if the circulating fluid temperature drops below 3°C.
    - Circulating fluid is heated by the pump power generated by pump operation. When the circulating fluid temperature reaches 5°C or higher, the pump will stop operating automatically.
  - WARMING-UP————— Function to maintain the circulating fluid at the warming-up setting temperature when operation is stopped during winter time or at night by conducting automatic operation and heating the circulating fluid with heat generated by the pump.
    - Pump automatically continues operating until the circulating fluid temperature rises up to +2°C, which is the warming-up setting temperature.
    - Pump automatically stops operating when the circulating fluid temperature rises up to +2°C which is the warming-up setting temperature.
    - Pump automatically restarts operation when the circulating fluid temperature drops to -2°C which is the warming-up set temperature.

**⚠ CAUTION**





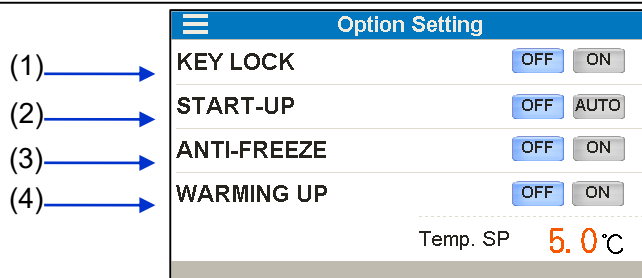





- The “ANTI-FREEZING” and “WARMING-UP” functions operate when the power supply is ON and the product operation is stopped.
- Fully open the valve or manual by-pass valve that was installed by the user to let the circulating fluid circulate when the pump operation automatically starts.



Setting of KEY-LOCK, START-UP operation, ANTI-FREEZING and WARMING-UP

Table 5.4-10 Settings of key-lock, startup operation, anti-freezing and warming-up

No.	Indication	Item	Explanation		Setting range
(1)	KEY LOCK	Key-lock	 *	Disabled	—
				Enabled	
(2)	START-UP	Startup operation	 *	Disabled	—
				Enabled	
(3)	ANTI-FREEZE	Anti-freezing	 *	Disabled	—
				Enabled	
(4)	WARMING UP	Warming-up	 *	Disabled	—
				Enabled	
		TEMP SP	Set temperature	5.0 to 35.0 °C * 5.0 °C	

\*By default

•Continuing pump operation

- 2.** Continuing pump operation can be set.  
Refer to “■ About continuous pump operation function” (P.5-44) for this function.  
This function is set to “Disabled” by default.

Following items can be set on “Continuous pump operation” setting screen:

- Pump operation sustainable temperature
- Pump operation sustainable time

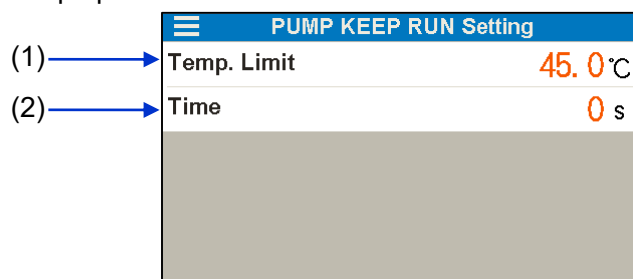

Setting for continuous pump operation

Table 5.4-11 Settings for continuous pump operation

No.	Indication	Item	Explanation	Setting range
(1)	Temp. Limit	Pump operation sustainable temperature	“Continuous pump operation” ends when the temperature reaches the set temperature.	5.0 to 50.0 °C * 45.0 °C
(2)	Time	Pump operation sustainable time	“Continuous pump operation” ends when the set time has elapsed. Set time: 0 sec—this function is “Disabled”	0 to 9999sec * 0sec

\* By default

■ About continuous pump operation function

This function allows just the pump to continue operating after some alarms are activated. Alarms that allow continuous pump operation are shown in Table 5.4-12 Alarms that allow continuous pump operation (1/2) and Table 5.4-13 Alarms that allow continuous pump operation (2/2).

“Continuous pump operation” ends if any one of the following conditions is met, and the product stops operating:

- (1) After activation of the alarm, the temperature has reached the “Pump operation sustainable temperature” from the temperature at which pump-only operation starts.
- (2) After activation of the alarm, the time reached the “Pump operation sustainable time” starting from the time at which pump-only-operation started

Table 5.4-12 Alarms that allow continuous pump operation (1/2)

Alarm No.	Alarm name	Operation	Alarms that allow continuous pump operation
AL01	Low Level FLT	[FLT]	✕
AL02	Low Level WRN	[WRN]	○
AL06	Fan Inverter	[FLT]	○
AL09	High Temp. FLT	[FLT]	✕
AL10	High Temp.	[OFF]*/ [WRN]	-
		[FLT]	○
AL11	Low Temp.	[OFF]*/ [WRN]	-
		[FLT]	○
AL12	TEMP READY ALARM	[OFF]*/[WRN]	-
		[FLT]	○
AL17	HX In High Temp. FLT	[FLT]	✕
AL18	Press. Sensor	[OFF] / [WRN]	-
		[FLT]*	✕
AL19	High Press.	[OFF] / [WRN]	-
		[FLT]*	✕
AL20	Low Press.	[OFF] / [WRN]	-
		[FLT]*	○

\* Default setting.

Table 5.4-13 Alarms that allow continuous pump operation (2/2)

Alarm No.	Alarm name	Operation	Alarms that allow continuous pump operation
AL28	High Electric conductivity (Option D only)	[OFF] / [WRN]*	-
AL29	No Power Supply	FLT	○
AL30	Digital input 1	[OFF] / [WRN]	-
		[FLT]*	○
AL31	Digital input 2	[OFF] / [WRN]	-
		[FLT]*	○
AL34	Communication	[OFF] / [WRN]*	-
		[FLT]	○
AL35	Ambient Temp.	[OFF]* / [WRN]	-
AL36	Maintenance	[OFF]* / [WRN]	-
AL37	Refrigeration Circuit	[FLT]	○
AL38	Sensor	[FLT]	×
AL39	Controller	[FLT]	×
AL40	Compressor Inverter	[FLT]	○
AL41	Compressor Inverter Comm.	[FLT]	○
AL42	Pump Inverter	[FLT]	×
AL43	Pump Inverter Comm.	[FLT]	×

\* Default setting.

- "FLT" : Operation stops when alarm occurs; "WRN": operation continues when alarm occurs;  
 "OFF": alarm is disabled.

• Ambient temperature alarm (AL35) and maintenance alarm (AL36)

**3.** Following alarms can be set for this product:

- AL35: Ambient temperature alarm— the alarm “AL35” activates when the ambient temperature value of the product rises/drops out of the range between 2°C and 45°C. This function is set to “OFF” (disabled) by default.
- AL36: Maintenance alarm— “Maintenance reminder” can be assigned to alarm “AL36” as an alarm signal. This function is set to “Disabled” by default.

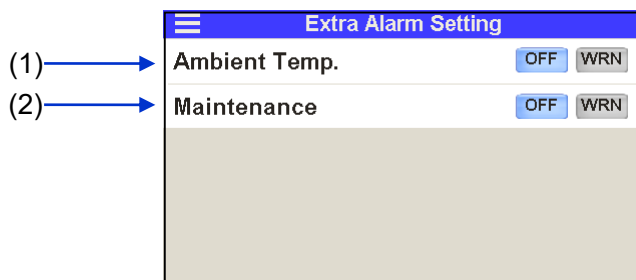

Setting for ambient temperature alarm (AL35) and maintenance alarm (AL36)

Table 5.4-14 Settings for ambient temperature alarm (AL35) and maintenance alarm (AL36)

No.	Indication	Item	Explanation		Remarks
(1)	Ambient Temp.	AL35: Ambient temperature alarm	OFF *	Disabled	The alarm activates when the ambient temperature sensor is outside of the range between 2°C and 45°C.
			WRN	Operation continues during the alarm	
(2)	Maintenance	AL36: Maintenance alarm	OFF *	Disabled	If “WRN” is selected, the alarm “AL36” activates when “Maintenance reminder” is issued.
			WRN	Operation continues during the alarm	

\* By default



•TEMP OUT signal

- 4. Set “TEMP OUT” signal.  
 “TEMP OUT” signal has a function to make an arbitrary selection from the following six alarm signals to output a “TEMP OUT” signal from a contact or serial communication.  
 This function is set to “OFF” (disabled) by default.

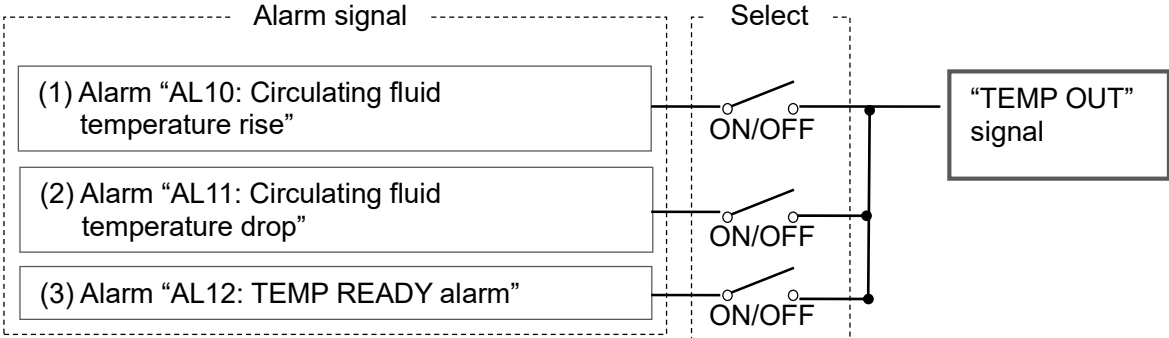

TEMP OUT signal output chart

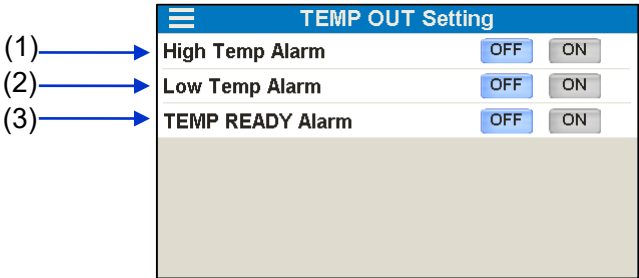

Setting screen of TEMP OUT signal

Table 5.4-15 Settings for TEMP OUT signal

No.	Indication	Explanation	Setting	
(1)	High Temp. Alarm	Alarm "AL10: circulating fluid temperature rise"	OFF *	Disabled
			ON	Enabled
(2)	Low Temp. Alarm	Alarm "AL11: circulating fluid temperature drop"	OFF *	Disabled
			ON	Enabled
(3)	TEMP READY Alarm	Alarm "AL12: TEMP READY alarm"	OFF *	Disabled
			ON	Enabled

\* By default

•Data reset

5. Reset the product settings to the default settings.  
 The settings can be reset on "Data reset" setting screen.  
 "Date and time," "Operation time" and "Alarm history" are not reset.

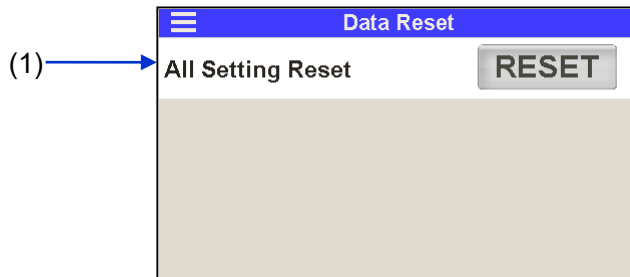

Data reset setting screen

Table 5.4-16 Data reset setting

No.	Indication	Item	Explanation	
(1)	All Setting Reset	Data reset		Set values are reset to default settings.

### 5.4.9 Communication setting screen

A screen for shifting to the following setting screens is displayed if [ **Comm. Setting** ] button on the menu is pressed.

- Setting screen for communication error (AL34) and contact input signal detection alarm (AL30 and AL31)
- Setting screen for serial communication
- Setting screen for analog output
- Setting screen for contact input signal form
- Setting screen for contact output signal 1 to 3
- Setting screen for contact output signal 4 to 6

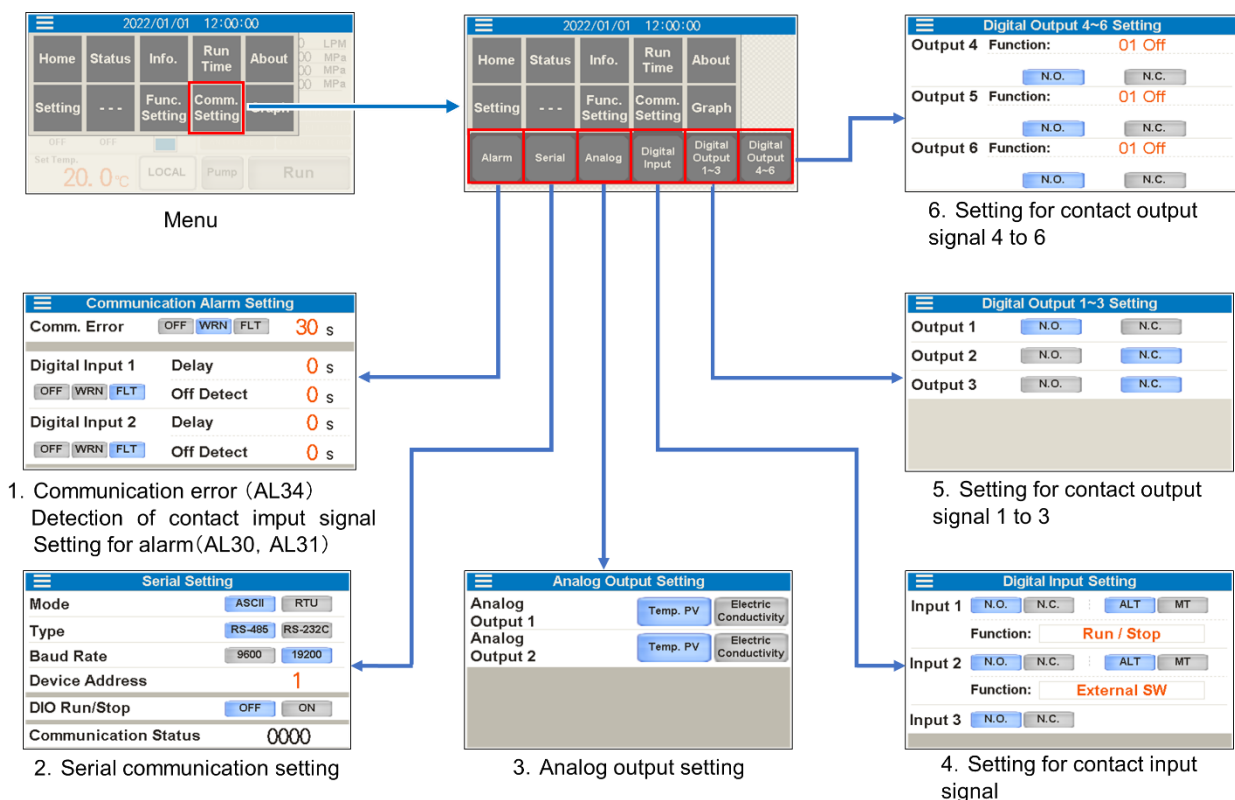

• Setting for communication error (AL34)/contact input signal detection (AL30 and AL31)

**1.** Set communication error (AL34) and contact input signal detection.

- Communication error (AL34)
 

The alarm “AL34: communication error” is activated if no request message from the host computer arrives within the wait time during use of serial communication. Operation at the time of alarm and message waiting time can be set.
- Detection of contact input signal (AL30 and AL31)
 

The product has two contact inputs available to detect the contact input signal. This allows reading and monitoring the contact signal from an external switch. If abnormality is detected in an external switch, this can activate an alarm. Options to select “Continuous monitoring” or “Monitoring during operation” are available. Also, the detection start time after the start of operation and the detection end time can be set.

  - If the signal of “Contact input 1” is detected: the alarm “AL30: Detection of contact input 1 signal” is activated.
  - If the signal of “Contact input 2” is detected: the alarm “AL31: Detection of contact input 2 signal” is activated.
  - “Delay” time: sets the start time to detect the contact input signal after the start of operation.
  - “Off detect” time: sets the time between the detection of the contact input OFF signal and the activation of the alarm.

Table 5.4-17 Monitoring method for contact input signal

“Delay” time	Monitoring method
0sec	Continuous monitoring
1 to 300sec	Monitoring during operation

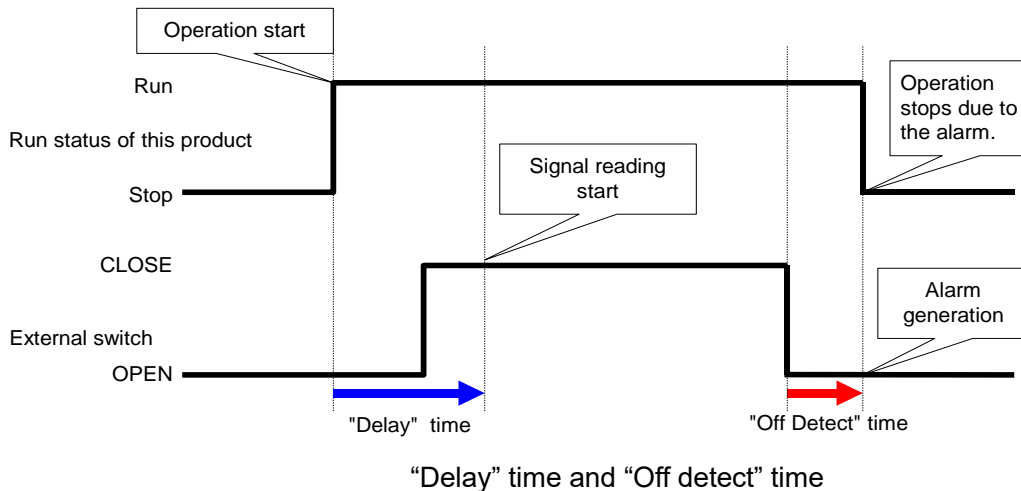

This function is set to “Disabled” by default. Refer to “Setting of contact input signal form” (P.5–54) for details. Contact input signal can be used to perform the “Run/Stop” of the product. Refer to “Setting of contact input signal form” (P.5–54) for the setting method.

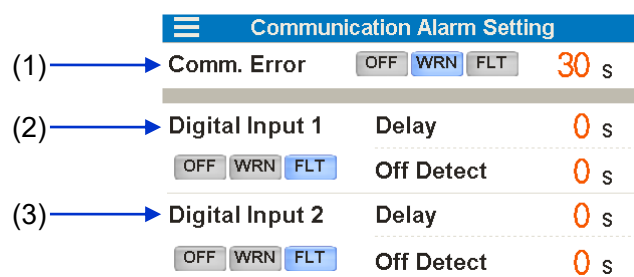

Communication error, detection of contact input signal and operation setting

Table 5.4-18 Communication error, detection of contact input signal and operation setting

No.	Indication	Item	Setting and selection		Setting range	
(1)	Comm. Error	Alarm "AL34: Communication error"	OFF	Disabled	Waiting time	30 to 600sec *30sec
			WRN *	Operation continues during the alarm		
			FLT	Operation stops during alarm		
(2)	Digital Input 1	Alarm "AL30: Detection of contact input 1 signal"	OFF	Disabled	Delay	0 to 300sec *0sec
			WRN	Operation continues during the alarm	Off Detect	0 to 10sec *0sec
			FLT *	Operation stops during alarm		
(3)	Digital Input 2	Alarm "AL31: Detection of contact input 2 signal"	OFF	Disabled	Delay	0 to 300sec *0sec
			WRN	Operation continues during the alarm	Off Detect	0 to 10sec *0sec
			FLT *	Operation stops during alarm		

\*By default

•Serial communication setting

## 2. Set serial communication.

The following operations can be performed by the serial communication RS-232C/RS-485:

- To run/stop the product
- To change the set value of circulating fluid temperature
- To readout the circulating fluid temperature, pressure, flow rate and electrical conductivity (Option D)
- To readout the status of respective parts of the product (e.g., operation status and content of alarm)

This section describes the operation of the "Serial communication setting" screen. Refer to "Communication Function" of Operation Manual for details such as for communication messages.

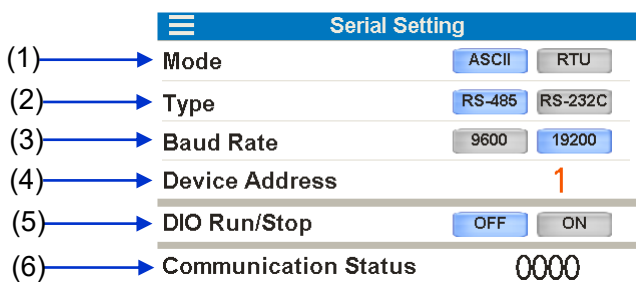

Serial communication setting

Table 5.4-19 Setting of serial communication

No.	Indication	Item	Setting, selection and display	
(1)	Mode	Communication format	ASCII *1	ASCII code
			RTU	Binary data
(2)	Type	Standard	RS-485 *1	EIA RS-485
			RS-232C	EIA RS-232C
(3)	Baud Rate	Communication speed	9600	9600 bps
			19200 *1	19200 bps
(4)	Device Address	Slave address	1 to 32 1 *1	Select from 1 to 32
(5)	DIO Run/Stop *2	"Run/stop" by contact input	OFF *1	Disabled
			ON	Enabled
(6)	Communication Status	Communication status	0000	Displays the communication status

\*1 By default

\*2 "Run/stop" operation of the product is carried out by the contact input signal, and by reading/writing the "Change in set value of circulating fluid temperature" and "Operation status" by serial communication.

•Setting of analog output signal

- 3.** The product has two analog outputs. The following signals can be output as analog signals:
- Analog output signal 1—“ Circulating fluid discharge temperature” or “Circulating fluid electric conductivity” \*.
  - Analog output signal 2—“ Circulating fluid discharge temperature” or “Circulating fluid electric conductivity” \*

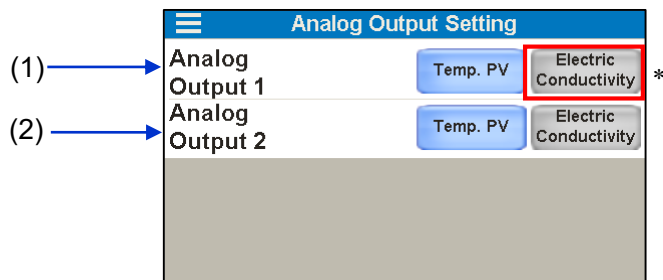

Setting of analog output signal

\* In the case of option D" With electrical conductivity control", it can be set.

Table 5.4-20 Setting of analog output signal

No.	Indication	Item	Setting, selection and display		Output	
(1)	Analog Output 1	Analog output signal 1	Temp. PV	*1	Circulating fluid discharge temperature	0~100°C: 0~10V
			Electric Conductivity	*2	Circulating fluid electric conductivity	0.1~50.0μS/cm : 0.02~10.0V
(2)	Analog Output 2	Analog output signal 2	Temp. PV	*1	Circulating fluid discharge temperature	0~100°C: 0~10V
			Electric Conductivity	*2	Circulating fluid electric conductivity	0.1~50.0μS/cm : 0.02~10.0V

\*1 By default

\*2 Option D" With electrical conductivity control" only.

• Setting of contact input signal form

**4.** The type and form of contact input signal are set. Following items can be set for contact input signal 1 and 2:

- Contact type...selects [ **N.O.** ] (A contact) or [ **N.C.** ] (B contact)
- Signal form...selects [ **ALT** ] (alternate) or [ **MT** ] (momentary)
- Signal type...selects “OFF” (disabled), “External switch” (external switch signal) or “Run/Stop” (run/stop) signal.

“Operation mode” can be switched from “Local mode/Serial mode” to “DIO mode” by inputting a contact signal in contact input 3. Refer to the “Communication Function” of Operation Manual for details.

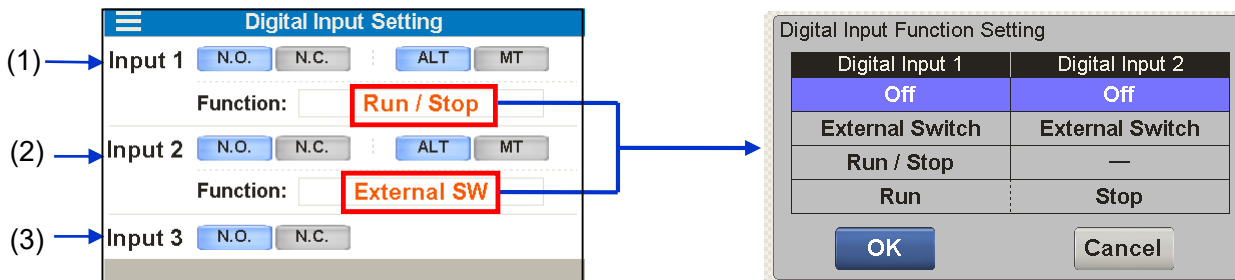

Setting of contact input signal form

Table 5.4-21 Setting of contact input signal form

No.	Indication	Item	Setting and selection																			
(1)	Input 1	Contact input signal 1	<table border="1"> <tr> <td rowspan="2">Contact type</td> <td><b>N.O.</b> *1</td> <td>A contact (normally open)</td> </tr> <tr> <td><b>N.C.</b></td> <td>B contact (normally closed)</td> </tr> <tr> <td rowspan="2">Signal form</td> <td><b>ALT</b> *1</td> <td>Alternate</td> </tr> <tr> <td><b>MT</b></td> <td>Momentary</td> </tr> <tr> <td rowspan="4">Signal type</td> <td>[Off]</td> <td>Disabled</td> </tr> <tr> <td>[External Switch]</td> <td>External switch signal</td> </tr> <tr> <td>[Run/Stop] *1</td> <td>Run/stop signal</td> </tr> <tr> <td>[Run] *2</td> <td>Run signal</td> </tr> </table>	Contact type	<b>N.O.</b> *1	A contact (normally open)	<b>N.C.</b>	B contact (normally closed)	Signal form	<b>ALT</b> *1	Alternate	<b>MT</b>	Momentary	Signal type	[Off]	Disabled	[External Switch]	External switch signal	[Run/Stop] *1	Run/stop signal	[Run] *2	Run signal
			Contact type		<b>N.O.</b> *1	A contact (normally open)																
				<b>N.C.</b>	B contact (normally closed)																	
			Signal form	<b>ALT</b> *1	Alternate																	
				<b>MT</b>	Momentary																	
			Signal type	[Off]	Disabled																	
[External Switch]	External switch signal																					
[Run/Stop] *1	Run/stop signal																					
[Run] *2	Run signal																					
(2)	Input 2	Contact input signal 2	<table border="1"> <tr> <td rowspan="2">Contact type</td> <td><b>N.O.</b> *1</td> <td>A contact (normally open)</td> </tr> <tr> <td><b>N.C.</b></td> <td>B contact (normally closed)</td> </tr> <tr> <td rowspan="2">Signal form</td> <td><b>ALT</b> *1</td> <td>Alternate</td> </tr> <tr> <td><b>MT</b></td> <td>Momentary</td> </tr> <tr> <td rowspan="4">Signal type</td> <td>[Off]</td> <td>Disabled</td> </tr> <tr> <td>[External Switch] *1</td> <td>External switch signal</td> </tr> <tr> <td>[Stop] *2</td> <td>Stop signal</td> </tr> </table>	Contact type	<b>N.O.</b> *1	A contact (normally open)	<b>N.C.</b>	B contact (normally closed)	Signal form	<b>ALT</b> *1	Alternate	<b>MT</b>	Momentary	Signal type	[Off]	Disabled	[External Switch] *1	External switch signal	[Stop] *2	Stop signal		
			Contact type		<b>N.O.</b> *1	A contact (normally open)																
				<b>N.C.</b>	B contact (normally closed)																	
			Signal form	<b>ALT</b> *1	Alternate																	
				<b>MT</b>	Momentary																	
			Signal type	[Off]	Disabled																	
[External Switch] *1	External switch signal																					
[Stop] *2	Stop signal																					
(3)	Input 3	Contact input signal 3 *3		<table border="1"> <tr> <td rowspan="2">Contact type</td> <td><b>N.O.</b> *1</td> <td>A contact (normally open)</td> </tr> <tr> <td><b>N.C.</b></td> <td>B contact (normally closed)</td> </tr> </table>	Contact type	<b>N.O.</b> *1	A contact (normally open)	<b>N.C.</b>	B contact (normally closed)													
			Contact type	<b>N.O.</b> *1		A contact (normally open)																
				<b>N.C.</b>	B contact (normally closed)																	

\*1 By default.

\*2 This setting assigns “Run” signal to “Contact input 1” and “Stop” signal to “Contact input 2”.

\*3 The signal form of contact input 3 is “Momentary”.



•Setting of contact output signal 1 to 3

**5.** Set contact output signal 1 to 3. Contact output signal is continuously output.  
 The signal type of contact output signal 1 to 3 is fixed. Contact output signal 4 to 6 can be used to change the signal type. The contact type of the following contact output signals can be set:

- Contact output signal 1 “Operation status” — selects “N.O.” (A contact) or “N.C.” (B contact).
- Contact output signal 2 “FLT alarm” — selects “N.O.” (A contact) or “N.C.” (B contact).
- Contact output signal 3 “WRN alarm” — selects “N.O.” (A contact) or “N.C.” (B contact).

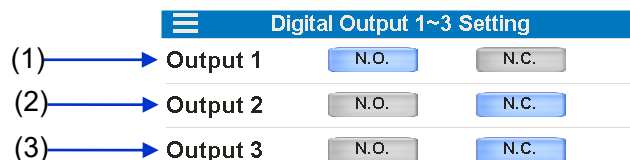

Setting of contact output signal 1 to 3

Table 5.4-22 Setting of contact output signal 1 to 3

No.	Indication	Item		Setting and selection	
(1)	Output 1	Contact output signal 1	Operation status signal	<input type="radio"/> N.O. *	A contact (normally open)
				<input type="radio"/> N.C.	B contact (normally closed)
(2)	Output 2	Contact output signal 2	Operation stop (FLT) alarm status signal	<input type="radio"/> N.O.	A contact (normally open)
				<input type="radio"/> N.C. *	B contact (normally closed)
(3)	Output 3	Contact output signal 3	Continuous operation “WRN” alarm status signal	<input type="radio"/> N.O.	A contact (normally open)
				<input type="radio"/> N.C. *	B contact (normally closed)

\* By default

•Setting of contact output signal 4 to 6

**6.** Set contact output signal 4 to 6. Contact output signal is continuously output.  
 A “Signal type” for contact output signal 4 to 6 can be selected by the customer. Refer to “Table 5.4-24 Signal type for contact output signals 4 to 6.”  
 Select the “Contact type” and “Signal type” for contact output signals 4 to 6.

- Contact output signal 4—selects “Signal type” and “N.O.” (A contact ) or “N.C.” (B contact).
- Contact output signal 5—selects “Signal type” and “N.O.” (A contact ) or “N.C.” (B contact).
- Contact output signal 6—selects “Signal type” and “N.O.” (A contact ) or “N.C.” (B contact).

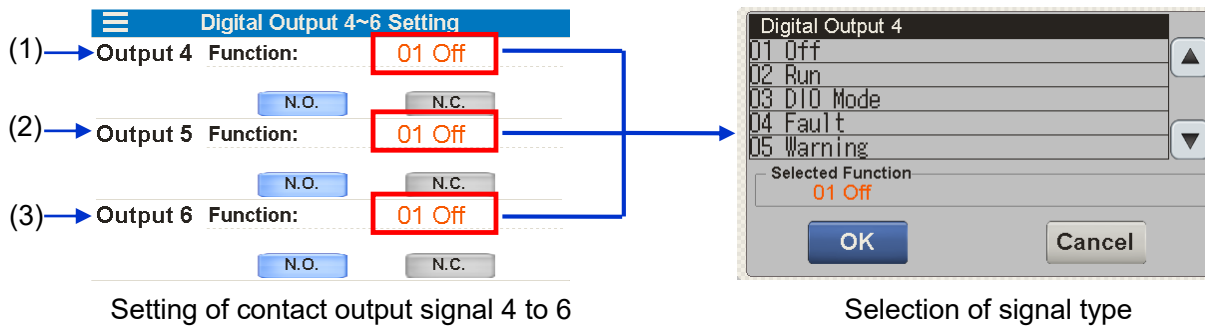

Setting of contact output signal 4 to 6

Selection of signal type

Table 5.4-23 Setting of contact output signal 4 to 6

No.	Indication	Item	Signal type	Contact type	
(1)	Output 4 Function	Contact output signal 4	Select from "Table 5.4-24 Signal type for contact output signal 4 to 6" * [Off]	<input type="button" value="N.O."/> *	A contact (normally open)
				<input type="button" value="N.C."/>	B contact (normally closed)
(2)	Output 5 Function	Contact output signal 5		<input type="button" value="N.O."/> *	A contact (normally open)
				<input type="button" value="N.C."/>	B contact (normally closed)
(3)	Output 6 Function	Contact output signal 6		<input type="button" value="N.O."/> *	A contact (normally open)
				<input type="button" value="N.C."/>	B contact (normally closed)

\*By default

Table 5.4-24 Signal type for contact output signal 4 to 6

No.	Indication	Item	Contact type	Explanation
1	Off	Disabling	N.O.	Normally open
			N.C.	Normally close
2	Run	Operation status signal	N.O.	Operation : closed
			N.C.	Stop : closed
3	DIO Mode	DIO mode signal	N.O.	DIO mode : closed
			N.C.	DIO mode : open
4	Fault	Operation stop "FLT" alarm status signal	N.O.	the time of alarm : closed
			N.C.	the time of alarm : open
5	Warning	Continuing operation "WRN" alarm status signal	N.O.	the time of alarm : closed
			N.C.	the time of alarm : open
6	Alarm	Alarm status signal	N.O.	the time of alarm : closed
			N.C.	the time of alarm : open
7	Maintenance	Maintenance reminder status signal	N.O.	Maintenance reminders occurred : closed
			N.C.	Maintenance reminders occurred : open
8	TEMP READY	TEMP READY signal	N.O.	TEMP READY status : closed
			N.C.	TEMP READY status : open
9	TEMP OUT	TEMP OUT signal	N.O.	TEMP OUT status : closed
			N.C.	TEMP OUT status : open
10	EXTERNAL TEMP	None	—	—
11	START-UP	Startup setting status signal	N.O.	Enabled : closed
			N.C.	Enabled : open
12	ANTI-FREEZEING	Anti-freezing setting status signal	N.O.	Enabled : closed
			N.C.	Enabled : open
13	WARMING UP	Warming up setting status signal	N.O.	Enabled : closed
			N.C.	Enabled : open
14	Digital Input 1	Pass through signal of the contact input signal 1	N.O.	Output the input signal as it is
			N.C.	Reverse output of the input signal
15	Digital Input 2	Pass through signal of the contact input signal 2	N.O.	Output the input signal as it is
			N.C.	Reverse output of the input signal
16	Mode Request Input	Mode request input signal(DIO) (Pass through signal of the contact input signal 3)	N.O.	Output the input signal as it is
			N.C.	Reverse output of the input signal
17	Select Alarm	Selected alarm status signal	N.O.	Selected alarm occurrence : closed
			N.C.	Selected alarm occurrence : open
Refer to "Table 5.4-25 List of alarm selection" for selectable alarms.				
18	Select Maintenance	Maintenance remainders status signal	N.O.	Selected maintenance reminders occurred : closed
			N.C.	Selected maintenance reminders occurred : open
About selectable maintenance remainders Refer to "Table 5.4-26 List of maintenance reminders".				

Table 5.4-25 List of alarm selection \*1

Alarm No.	indication	Explanation
AL01	Low Level FLT	Abnormal low tank fluid level
AL02	Low Level WRN	Low tank fluid level
AL06	Fan Inverter	Fan failure
AL09	High Temp. FLT	Abnormal rise of circulating fluid temperature
AL10	High Temp.	Circulating fluid temperature rise
AL11	Low Temp.	Circulating fluid temperature drop
AL12	TEMP READY ALARM	TEMP READY alarm
AL17	HX In High Temp. FLT	Abnormal rise in heat exchanger inlet temperature
AL18	Press. Sensor	Failure of circulating fluid discharge pressure sensor
AL19	High Press.	Circulating fluid discharge pressure rise
AL20	Low Press.	Circulating fluid discharge pressure drop
AL28 *2	High Electric Conductivity	Electric conductivity increase (Option D only)
AL29	No Power Supply	Power supply error
AL30	Digital Input 1	Contact input 1 signal detection
AL31	Digital Input 2	Contact input 2 signal detection
AL34	Communication	Communication error
AL35	Ambient Temp.	Outside of the ambient temperature range
AL36	Maintenance	Maintenance alarm
AL37	Refrigeration Circuit	Compressor circuit failure
AL38	Sensor	Sensor failure
AL39	Controller	Controller failure
AL40	Compressor Inverter	Compressor inverter error
AL41	Compressor Inverter Comm.	Compressor inverter communication error
AL42	Pump Inverter	Pump inverter error
AL43	Pump Inverter Comm.	Pump inverter communication error

\*1 Refer to "Chapter 6 Alarm Notifications and Troubleshooting".

\*2 For option D "With electrical conductivity control", you can select it.

Table 5.4-26 List of maintenance reminders \*1

Maintenance No.	Indication	Explanation
MT01	Pump	Pump maintenance
MT02	Compressor	Compressor maintenance
MT03	Fan	Fan maintenance
MT04	Dustproof Filter	Dust-proof filter maintenance
MT07	Low Battery	Battery maintenance
MT08	Pressure Sensor	Maintenance for circulating fluid discharge pressure sensor
MT11 *2	DI Filter	DI filter maintenance (Option D only)

\*1 Refer to "5.4.5 Check operation time screen and maintenance reminder"  
for "Maintenance reminder".

\*2 In the case of option D "With electrical conductivity control", to display.

### 5.4.10 Temperature waveform screen

Press [ Graph ] button on the menu to display “Temperature waveform” screen.

The “Temperature waveform” screen has following functions:

- Displays “Circulating fluid temperature waveform”. The sampling cycles are 1 sec. each.
- Displays “Circulating fluid temperature waveform”. The sampling cycles are 1 sec. each.
- “Temperature waveform” can be displayed up to approximately last 9 hours.

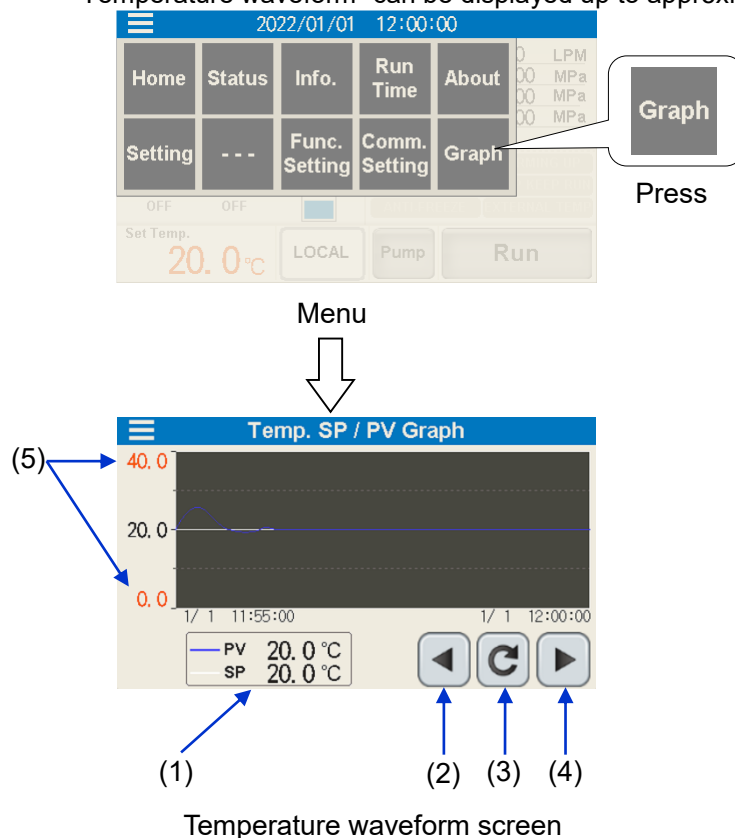

Table 5.4-27 Temperature waveform screen

No.	Item	Function	Explanation
(1)	PV	Circulating fluid temperature	Displays the current circulating fluid temperature.
	SP	Set circulating fluid temperature	Displays the set circulating fluid temperature.
(2)	Button	Time scroll	Press the button to shift the time axis to the past. This can be displayed up to approximately the last 9 hours.
(3)	Button	Update of temperature waveform	Press “Time scroll” button to stop updating the temperature waveform. Press this button to update the temperature waveform. * Collection of temperature data can continue even while the update of temperature waveform is stopped, by pressing “Time scroll” button.
(4)	Button	Time scroll	Press this button to shift the time axis forward.
(5)	Temperature range	Change of temperature range	A value can be entered to change the temperature range for temperature waveform.



# Chapter 6 Alarm Notifications and Troubleshooting

## 6.1 Alarm Notification

The product makes notifications in the order shown below when any alarm is generated.

- The screen automatically moves to the "Information" screen and displays alarm codes and alarm contents.  
(Refer to "5.4.4 Information screen" for the operation method of "Information" screen.)
- Contact signal of the contact input/output communication is output.
- It is possible to read the alarm status using serial communication. Refer to the Operation Manual Communication Function for more details.

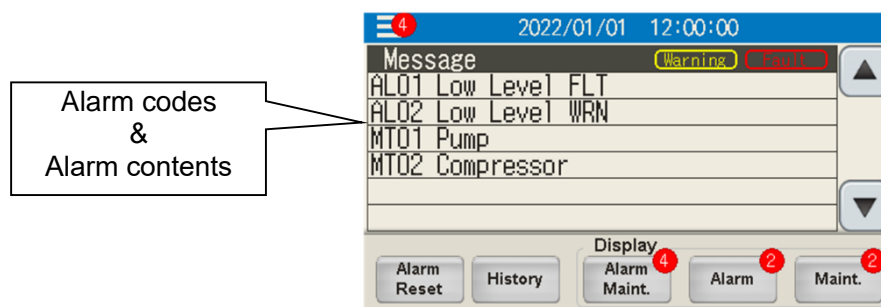

Information screen

## 6.2 Operation of this product when an alarm occurs

When an alarm occurs, this product operates in two ways depending on the content of the alarm.

- Operation continuation alarm : When an alarm occurs, this product continues to operate. The alarm content will display "WRN".
- Operation stop alarm : When an alarm occurs, this product stops. The alarm content will display "FLT".

There is an alarm content that allows you to select the action when an alarm occurs. There are also alarm contents that can disable (turn off) the alarm function. Refer to "Table 6.3-1 and 6.3-2 Alarm codes and troubleshooting".

## 6.3 Troubleshooting

### 6.3.1 Alarm contents, causes, and troubleshooting

Troubleshooting method varies depending on which alarm has been generated. Refer to "Table 6.3-1 and 6.3-2 Alarm codes and troubleshooting".

Instructions to reset the alarms after eliminating the causes of the alarms explained below.

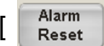
- Check the alarm contents displayed on the "Information" screen and remove the cause. Alarms cannot be canceled except this screen.  
The alarm can be reset by serial communication.  
Refer to the Operation Manual Communication Function for more details.
- [  ] Press the button
- The alarm is reset.  
Confirm that the alarm content on the "Information" screen has disappeared. The alarm signal of contact output and serial communication turns off.

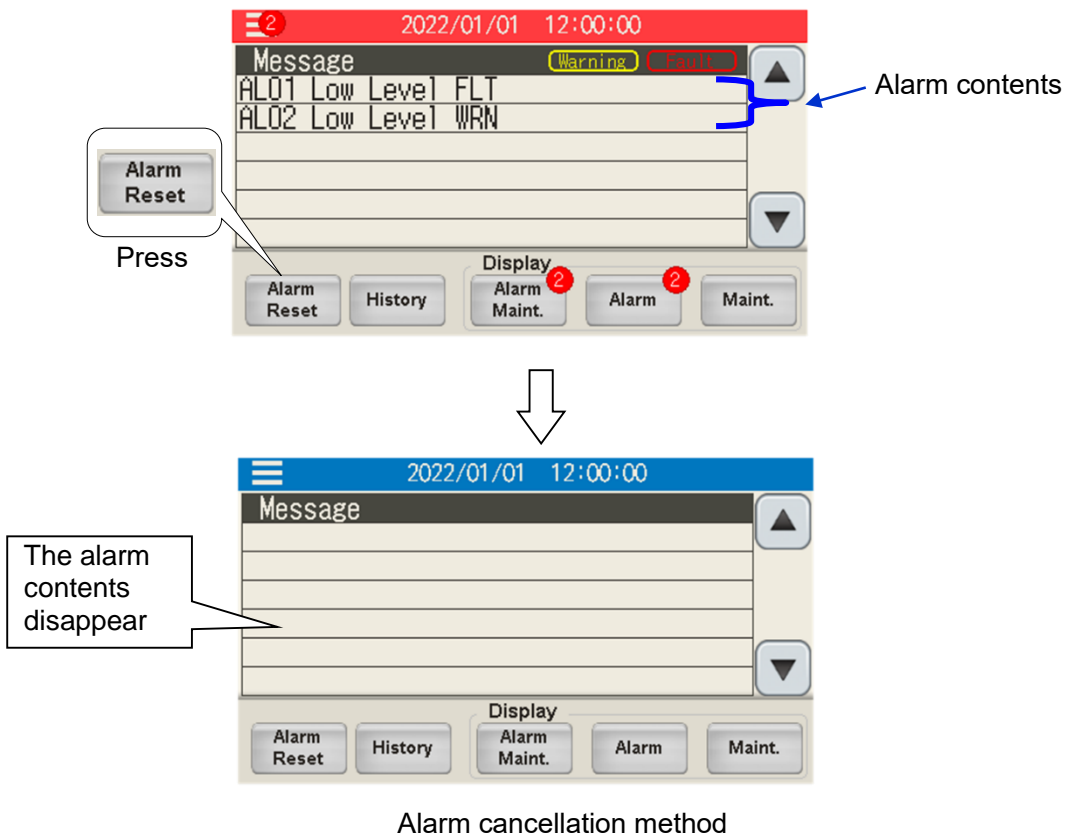



Table 6.3-1 Alarm codes and troubleshooting (1/2)

Alarm code	Alarm content		Default setting		Cause/Countermeasure (Please reset the alarm after eliminating the cause.)
	Sub code		Operation	Threshold	
AL01	Low Level FLT		FLT	—	The circulating fluid level has decreased. Refilling circulating fluid.
AL02	Low Level WRN		WRN	—	
AL06	Fan Inverter		FLT	—	Check that there is no abnormality with the power supply system (e.g. ground fault, short-circuit, voltage fluctuation, abnormal interphase voltage, open phase, surge).
AL09	Hgh Temp. FLT		FLT	55°C	<ul style="list-style-type: none"> <li>• Check that the ambient temperature, and heat load satisfy the specifications, and that the circulating fluid flow rate is more than the minimum flow rate.</li> <li>• Please review the setting value.</li> </ul>
AL10	Hgh Temp.		OFF *1	45°C *3	
AL11	Low Temp.		OFF *1	5°C *3	
AL12	TEMP READY ALARM		OFF *1	+1/-1°C *3	<ul style="list-style-type: none"> <li>• There may be causes such as large load fluctuation and flow rate fluctuation.</li> <li>• Please review the setting value.</li> </ul>
AL17	HX In High Temp. FLT		FLT	60°C	<ul style="list-style-type: none"> <li>• Check that the circulating fluid flow rate is more than the minimum flow rate.</li> <li>• Check that the heat load is within the specified range.</li> </ul>
AL18	Press. Sensor		FLT *1	—	Short-circuit or broken wire of the pressure sensor. Ask for the service.
AL19	High Press.		FLT *1	0.50MPa *3	Check that there is no bending, collapse, or clogging with the external piping.
AL20	Low Press.		FLT *1	0.03MPa *3	Restart the thermo-chiller and check if the pump runs.
AL28 *4	High Electric conductivity		WRN *2	45.0μS/cm *3	Replace DI filter.
AL29	No Power Supply		FLT	—	Shut off the power to this product and restart it without connecting usb port.
AL30	Digital input 1		FLT *1	—	Contact input has been detected.
AL31	Digital input 2		FLT *1	—	
AL34	Communication		WRN *1	—	No request message from the host computer. Try to send the request message again.
AL35	Ambient Temp.		OFF *2	2°C/45°C	Check the environment.

Table 6.3-2 Alarm codes and troubleshooting (2/2)

Alarm code	Alarm content	Default setting		Cause/Countermeasure (Please reset the alarm after eliminating the cause.)
	Sub code	Operation	Threshold	
AL36	Maintenance	OFF *2	—	*Maintenance reminder" occurred. Please maintain the corresponding part.
	1 Pump maintenance		20,000h	
	2 Compressor maintenance		30,000h	
	3 Fan maintenance		30,000h	
	4 Dust-proof filter maintenance		500h *3	
	7 Battery maintenance		Abnormal occurrence	
	8 Maintenance of circulating fluid discharge pressure sensor		500h *3	
11 DI filter maintenance *4	500h *3			
AL37	Refrigeration Circuit	FLT	—	Refrigerant circuit failed. • Check that the ambient temperature, heat load satisfy the specifications. • Check that the circulating fluid flow rate is more than the minimum flow rate. • Ask for the service.
	1 High compressor intake temp.		60°C	
	2 Low compressor intake temp.		-10°C	
	3 Super heat temp.		0°C	
	5 Refrigeration circuit high press. rise		—	
	6 Refrigeration circuit high press. drop		—	
	8 Refrigeration circuit low press. drop		—	
	9 Refrigeration circuit low press. rise		—	
	11 Compressor running failure		—	
12 Compressor discharge temp. rise	—			
AL38	Sensor	FLT	—	Short-circuit or broken wire of the sensor. Ask for the service.
	1 Circulating fluid temp. sensor		—	
	2 Heat exchanger inlet temp. sensor		—	
	3 Compressor discharge temp. sensor		—	
	4 Compressor intake temp. sensor		—	
	6 Ambient temp. sensor		—	
	9 Refrigeration circuit high press. sensor		—	
	10 Refrigeration circuit low press. sensor		—	
15 DI sensor *4	—			
AL39	Controller	FLT	—	Controller failed. Shut off the power to this product and restart it. If it does not return to normal, ask for service.
	1 EEPROM error		—	
	2 Internal communication error		—	
	3 FRAM error		—	
	5 Ref. memory error		—	
	6 Cir. memory error		—	
AL40	Compressor Inverter	FLT	—	Check that there is no abnormality with the power supply system (e.g. ground fault, short-circuit, voltage fluctuation, abnormal interphase voltage, open phase, surge).
AL41	Compressor Inverter Comm.	FLT	—	
AL42	Pump Inverter	FLT	—	
AL43	Pump Inverter Comm.	FLT	—	

\*1 Select from "OFF" / "WRN" / "FLT"

\*2 Select from "OFF" / "WRN"

\*3 The setting value can be changed.

\*4 Setting the electrical conductivity only when option 'D' is selected on.

## 6.4 Other Errors

### ■ How to check other errors

Possible causes and countermeasures for failures with no alarm code display are shown in "Table 6.4-1".

Table 6.4-1 Possible causes and countermeasures for failures without alarm code

Content of failure	Possible cause	Countermeasure
Touch panel displays nothing.	The breaker of the user's power supply or/and the optional breaker is/are not turned ON.	Turn ON the breaker.
	Breaker of this product is broken	Replace the breaker.
	No power supply. (e.g. Breaker(s) in the power supplying route has not been turned ON.)	Supply the power.
	The breaker for the user's facility or the optional breaker has tripped due to short-circuit or leakage of electricity.	Repair the short-circuited part or the electricity leaking part.
	The DC power supply has failed.	Replace the DC power.
The product does not operate after pressing the [  ] button.	Communication setting has been turned ON.	Check the setting of the operation mode.



# Chapter 7 Control, Inspection and Cleaning

## 7.1 Quality Control of Circulating Fluid and Facility Water

**⚠ WARNING**



**Use specified fluids only. If other fluids are used, they may damage the product, causing fluid leakage, or result in hazards such as electric shock or leakage of electricity.**  
**When using clear water (tap water), ensure that it satisfies the water quality criteria shown in the table below.**  
**If the water quality standards are not met, clogging or leakage in the facility water piping, or other problems such as refrigerant leakage, etc., may result.**

Table 7.1-1 Quality criteria for clean water (tap water)

	Item	Unit	Criterion	
			Circulating fluid	Facility water
Standard item	pH (at 25 °C)	—	6.0 to 8.0	6.5 to 8.2
	Electric conductance (at 25 °C)	[µS/cm]	100 to 300	100 to 800
	Chloride ion	[mg/L]	50 or less	200 or less
	Sulphate ion	[mg/L]	50 or less	200 or less
	Acid consumption (at pH 4.8)	[mg/L]	50 or less	100 or less
	Total hardness	[mg/L]	70 or less	200 or less
	Calcium hardness	[mg/L]	50 or less	150 or less
	Ionic silica	[mg/L]	30 or less	50 or less
Referential item	Iron	[mg/L]	0.3 or less	1.0 or less
	Copper	[mg/L]	0.1 or less	0.3 or less
	Sulfide ion	[mg/L]	Should not be detected any	Should not be detected any
	Ammonium ion	[mg/L]	0.1 or less	1.0 or less
	Residual chlorine	[mg/L]	0.3 or less	0.3 or less
	Free carbon dioxide	[mg/L]	4.0 or less	4.0 or less

\* Quoted from the standard "JRA-GL-02-1994", The Japan Refrigeration and Air Conditioning Industry Association.

**CAUTION**



**Replace the circulating fluid and/or the facility water if any problems are found during the regular check. Even if no problems are found, some of the water in the tank evaporates and impurity concentration in the circulating fluid increases. Replace the circulating fluid in the tank once every 3 months. Refer to the section "7.2 Inspection and Cleaning" for regular inspection.**

## 7.2 Inspection and Cleaning

### **WARNING**



- Do not perform key operation or setting of this equipment with wet hands. Do not touch the electrical parts such as the power supply plug. It may cause an electric shock.
- Do not splash water directly on the product or do not wash with water. It might cause electric shock, fire, or etc.
- Do not touch the fins directly when cleaning the dust-proof filter. It may cause injury.

### **WARNING**



- Shut off the power supply to this product before performing cleaning, maintenance or inspection, or it may cause electric shock, injury, burn, or etc.
- When the panel has been removed for the purpose of inspection or cleaning, mount the panel after the work is completed. If the product is operated with the panel removed or open, it may cause injury or electric shock.

### 7.2.1 Daily check

Check the items listed below. If any abnormality is found, stop the operation of the product and turn the power supply OFF, and ask for service.

Table 7.2-1 Daily check items

Item	Contents of check	
Installation condition	Check the installation condition of the product.	<ul style="list-style-type: none"> <li>• Check that there is no heavy object on the product or excessive force applying to the piping.</li> <li>• Temperature should be within the specification range of the product.</li> <li>• Make sure the ventilation grille is not obstructed. (For air-cooled type)</li> </ul>
Fluid leakage	Check piping connections.	Check that there is no fluid leakage from the connected parts of the piping.
Amount of circulating fluid	Check the fluid level gauge.	Fluid level should be between "HIGH" and "LOW" levels of the fluid level gauge.
Touch panel	Check the indications on the display.	The display on the screen is clear.
Circulating fluid temperature	Check on the touch panel.	There should be no problem for operation.
Circulating fluid discharge pressure	Check on the touch panel.	There should be no problem for operation.
Circulating fluid flow rate	Check on the touch panel.	There should be no problem for operation. If flow rate has become smaller, check for any clogging of the Y-strainer and clean it.
Operating condition	Check the operating condition of the product	<ul style="list-style-type: none"> <li>• There should be no abnormality with noise, vibration, smell, or generation of smoke.</li> <li>• That the alarm has not occurred</li> </ul>

### 7.2.2 Monthly check

Table 7.2-2 Contents of monthly check

Item	Contents of check	
Ventilating condition (air cooled type)	Clean the ventilating grilles.	Make sure the ventilating grilles are not clogged with dust, etc.

■ **Cleaning of air ventilation port (Air cooled type.)**

<b>CAUTION</b>	
	<b>If the fins of the air-cooled condenser become clogged with dust or debris, heat radiation performance declines. This will result in the reduction of cooling performance, and may stop the operation because the safety device is triggered.</b>

Clean the dust-proof filters with a long bristled brush or by air blow to prevent the fins from being deformed or damaged.

■ **Removal of the dust-proof filter**

1. The dust-proof filters are installed on the front and left sides of the product.
2. They can be removed as shown in the drawing below.  
Care should be taken not to deform or scratch the air cooled condenser (fins) while removing the filters.

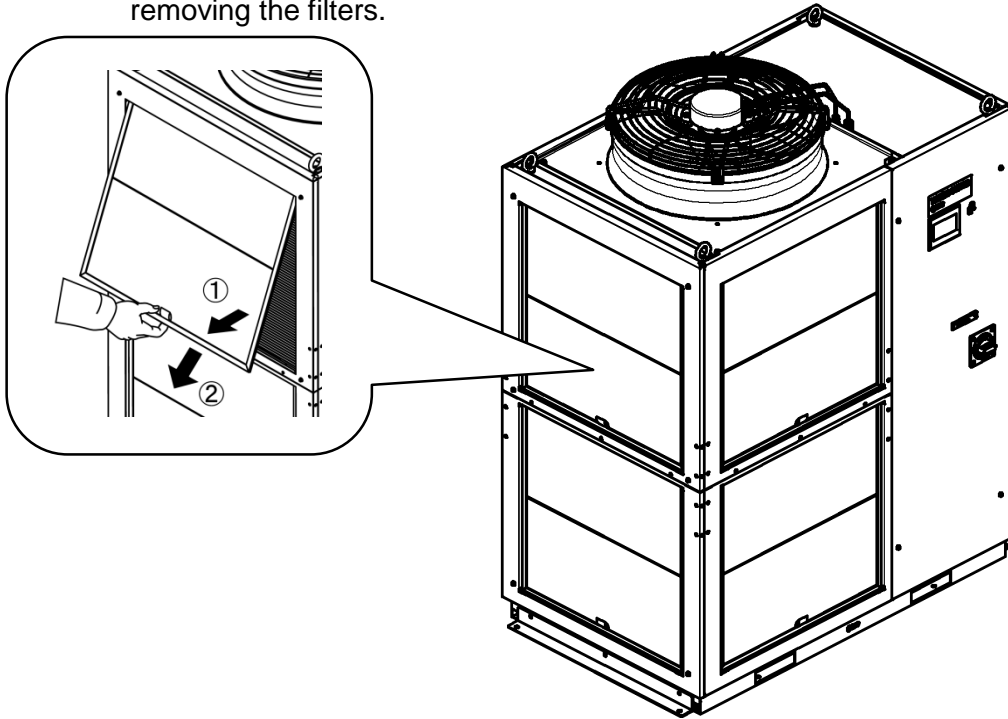

Fig. 7-1 Removal of the dust-proof filter

■ **Cleaning of dust-proof filter**

Clean the dust-proof filters with a long bristled brush or by air blow.

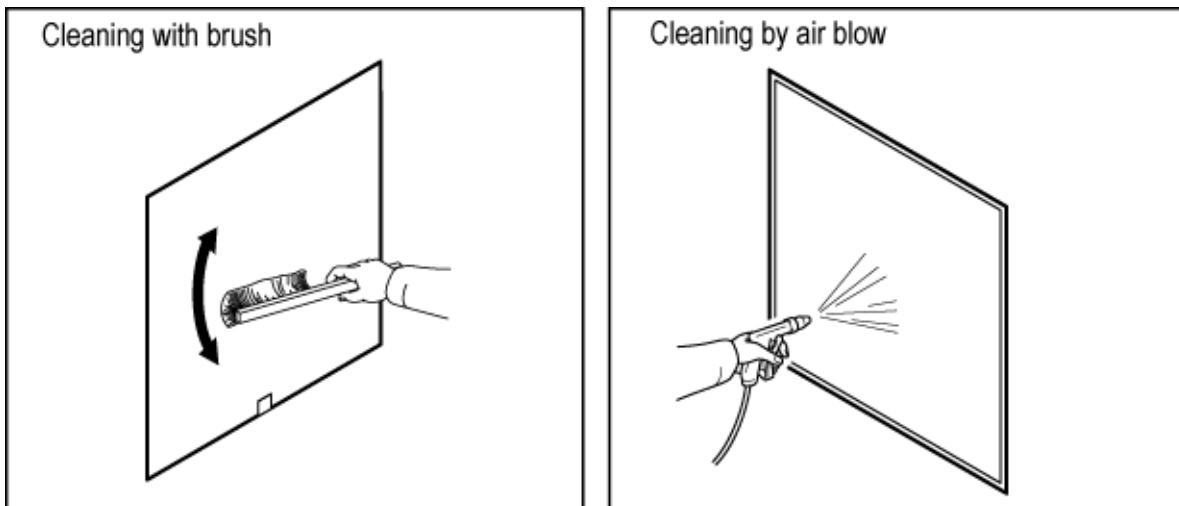

Fig. 7-2 Cleaning of the dust-proof filter



■ **Mounting of dust-proof filters**

Reassemble the filters in the reverse order to the removing procedure.

**7.2.3 Inspection every 3 months**

Table 7.2-3 Contents of every 3 months check

Item	Contents of check	
Power supply	Check the power supply voltage.	Make sure the supply voltage is within the specification range.
Circulating fluid	Replace the circulating fluid (clean/tap water) periodically.	<ul style="list-style-type: none"> <li>• Ensure that the fluid has not been contaminated and that there is no algae growth.</li> <li>• Circulating fluid inside the tank must be clean and there must not be foreign matter inside.</li> <li>• Use clean/tap water or pure water. The water quality must be within the range shown in Table 7.1-1 Quality criteria for clean water (tap water).</li> <li>* It is recommended to replace the circulating fluid every 3 months when periodic maintenance is performed.</li> </ul>
	Density control (When using 15% concentration ethylene glycol aqueous solution)	Density must be within the range of 15 % +5/-0.

■ **Replacement of circulating fluid**

- Replace the circulating fluid with new clean fluid periodically, to prevent algae or decompose.
- Circulating fluid to be supplied in the tank should satisfy the water quality specified in “Table 7.1-1 Quality criteria for clean water (tap water)”.
- Make sure that the concentration of ethylene glycol aqueous solution is 15% +5/0 when 15% ethylene glycol solution is used.
- When using the Y strainer provided as an accessory for piping, clean the screen mesh inside the strainer at the same time as when replacing the circulating fluid.
- Ensure that there is no circulating fluid in the thermo-chiller, user's equipment, and piping. Remove the cap and take out the screen mesh inside, and clean the screen mesh with compressed air or detergent. Use caution not to damage the screen mesh.
- Do not use chlorine-based or such types of detergents or cleansers.
- Put the screen mesh that has been cleaned into the groove in the cap, and reassemble it to the body of the strainer.

**CAUTION**



**If there is foreign matter accumulated or clogging in the facility water system, pressure loss increases with less flow rate, and it may damage the screen mesh.**

## 7.2.4 Inspection during winter season

### CAUTION



Keep the power supply ON for these functions. These functions do not start when the power is OFF.

#### ■ Anti-freezing function

This function prevents freezing of the circulating fluid while the product stops operation in the winter season with heat generated by automatically operating the pump. When there is a possibility of the circulating fluid freezing due to changes in the installation or operating environment (e.g. season, weather), set this function ON in advance.

\* For more details, refer to “KEY-LOCK, START-UP operating method, ANTI-FREEZING and WARMING-UP” (P.5-42).

#### ■ Warming up function

This function maintains the circulating fluid temperature to the set warming-up temperature with heat generated by automatically operating the pump in the winter season or at night.

When the time required for increasing the temperature of the circulating fluid needs to be shortened at startup, set this function ON in advance.

\* For more details, refer to “KEY-LOCK, START-UP operating method, ANTI-FREEZING and WARMING-UP” (P.5-42).

## 7.3 Operation Stop for an Extended Period of Time

If there is a concern that the product will not be operated for an extended period of time or there is a possibility of freezing during winter time, take measures according to the instructions shown below.

1. Turn OFF the earth leakage breaker of the user's power supply.

---

2. Discharge all the circulating fluid completely from the thermo-chiller.  
Refer to "7.3.1 Discharge of the circulating fluid" for the method of drain the circulating fluid from the product.

---

3. After discharging the circulating fluid, cover the product with a sheet (to be prepared by user) before storing the product.

### 7.3.1 Discharge of the circulating fluid

#### **WARNING**



- Before discharging the circulating fluid, stop the user's equipment and release the residual pressure.
- Be sure to wear protective shoes and gloves to prevent injury with the edge of the panel.

1. Turn OFF the breaker of the user's power supply.

---

2. Close the valve at the automatic fluid fill port.

---

3. Open the ball valve of the tank drain port to drain the circulating fluid.

**4.** [For Option D]

Remove the DI filter.

- 1) Remove the maintenance panel and remove the DI filter.  
(Refer to “7.4.1 Replacing the DI filter”.) Store the removed DI filter separately.
- 2) Install the DI filter temporary piping that was installed at the time of delivery.

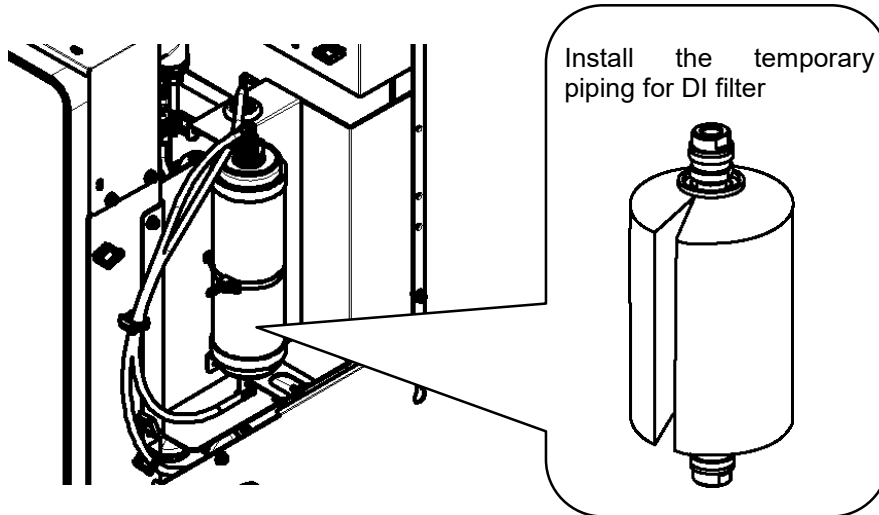

Fig. 7-3 Temporary pipe installation for DI filter(For option D)

- 
- 5.**
- After confirming that the circulating fluid has been sufficiently discharged from the product, customer's facilities and piping, perform an air purge (pressure less than 0.1 MPa, about 1 minute) from the circulating fluid outlet of the product.
- 
- Circulating fluid is drained from the drain port.

- 
- 6.**
- Close the ball valve after draining the circulating fluid.

## 7.4 Replacement of consumables

### **⚠ WARNING**



- Before discharging the circulating fluid, stop the user's equipment and release the residual pressure.
- Be sure to wear protective shoes and gloves to prevent injury with the edge of the panel.

### 7.4.1 Replacing the DI Filter **【For Option D】**

Connect DI filter inside this product. In the delivery state, "Temporary piping for DI filter" is connected. Install the attached "DI filter" according to the following procedure.

1. Turn off the earth leakage breaker of this product.
2. Remove the maintenance panel. Loosen the 6 fixing screws.

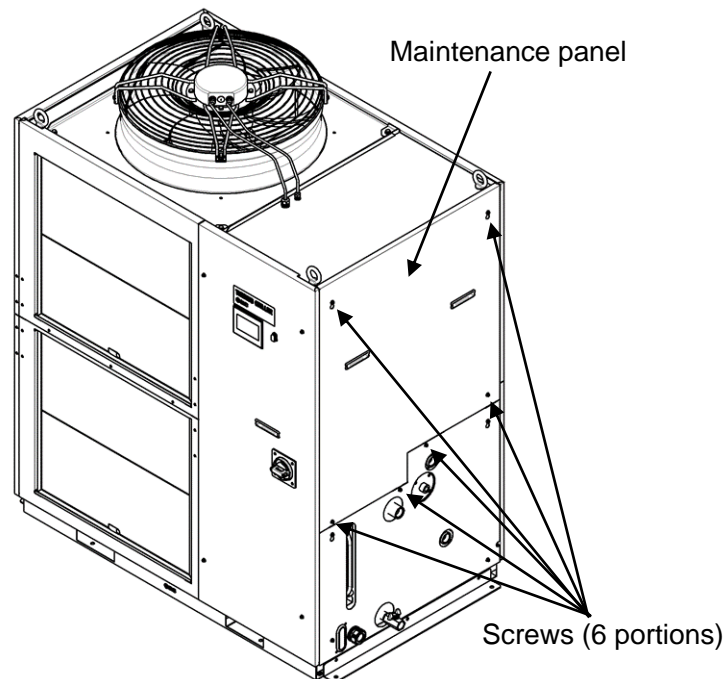
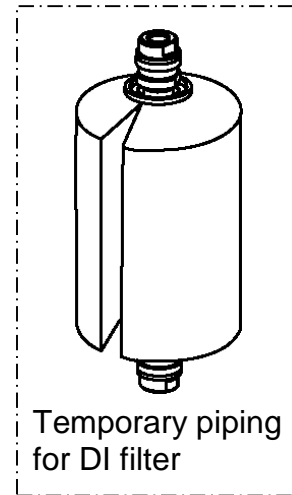
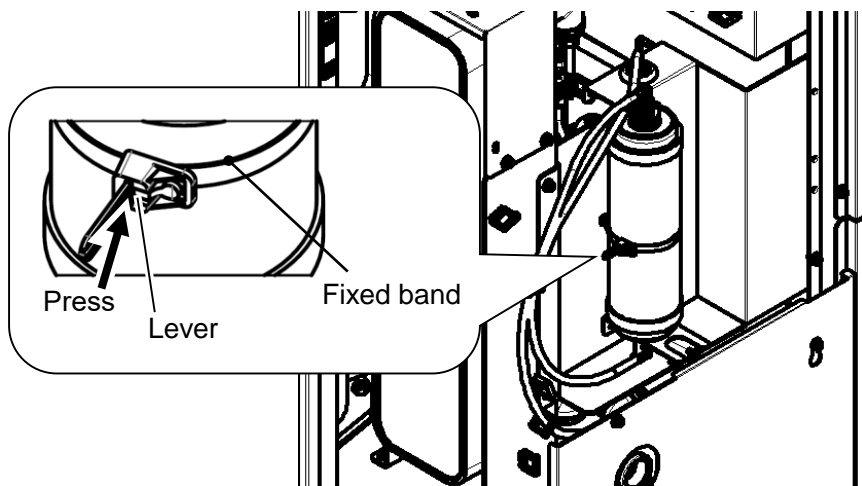
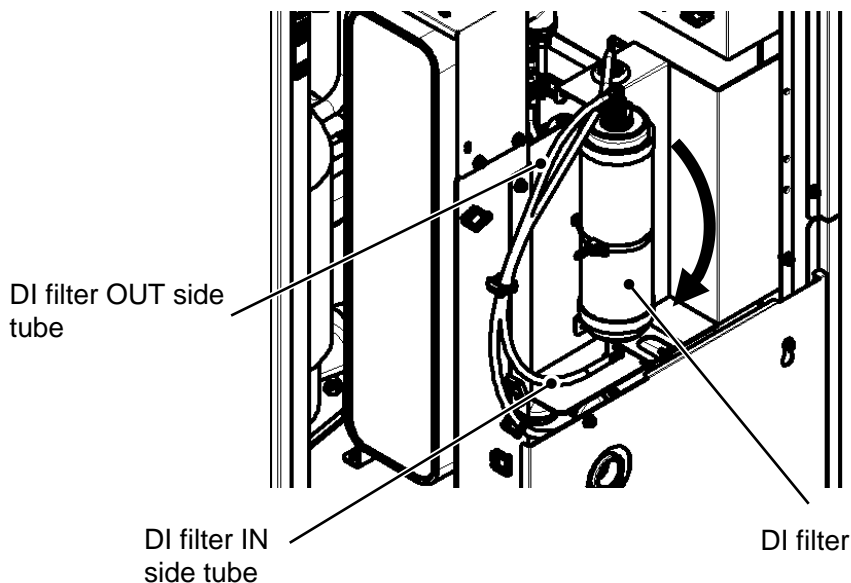

Fig. 7-4 Maintenance panel removal

- 3.** Remove DI filter fixed band by pushing lever on the band.  
 (The temporary piping for DI filter is connected at the time of delivery. "Temporary piping for DI filter" is used for long term storage of this product. Please keep it in a safe place.)



- 4.** Pull out the DI filter to the front. The DI filter has been connected to the tube.  
 Please allow excessive force is not applied to the tube.



- 5.** The connection fitting of the DI filter and the tube is connected by a fastener. O ring is used for the connection fitting. After removing the fastener, remove the connection fitting. Be careful not to apply force to the tube at this time. Also, please be careful not to damage the O ring.  
Both the IN side and the OUT side have the same shape. Remove the connection fitting on both sides and remove the DI filter.

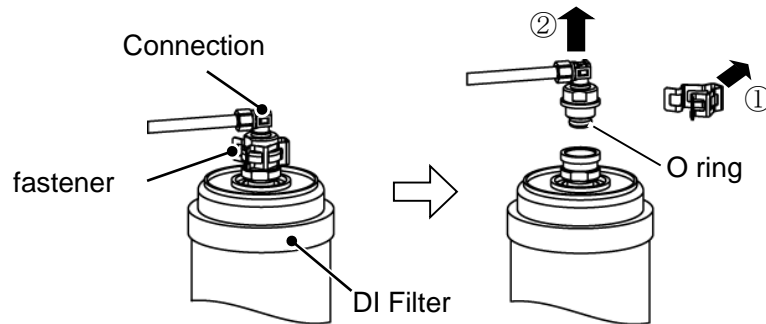

- 6.** Install the DI filter in the reverse order of removal. The DI filter has no flow direction. The DI filter IN-side tube on the lower side of the DI filter, please connect the DI filter OUT-side tube on the upper side. If connected reversely, the air in the DI filter will not escape, the DI filter function may not work properly.

- 7.** Secure the DI filter in a fixed band.

- 8.** Install the maintenance panel. (Recommended tightening torque: 3.0N·m)

## 7.4.2 Consumables

Table 7.4-1 Consumables

Part number	Name	Qty.	Remarks
HRL-S0153	Dust-proof filter	1 pc.	4 pcs. are used per unit
HRR-DF002	DI filter replacement cartridge	1 pc.	Option D only





# Chapter 8 Documents

## 8.1 Specifications

### 8.1.1 HRS400-A\*-46-\*

Table 8.1-1 Specifications

Model		HRS400-A*-46-*		
Cooling method		Air-cooled refrigeration		
Refrigerant		R410A(HFC)		
Quantity of refrigerant	kg	3.7		
Control method		PID control		
Ambient temperature *1	°C	-5 to 45		
Circulating fluid system	Circulating fluid *1 *2		Clean water, 15% ethylene glycol aqueous solution, Deionized water	
	Set temperature range *1	°C	5 to 35	
	Cooling capacity *3	kW	38	
	Heating capacity *4	kW	8	
	Temperature stability *5	°C	±0.1	
	Pump capacity	Rated flow rate (Outlet)	L/min	125 (0.45MPa)
		Maximum flow rate	L/min	180
		Maximum lifting height	m	68
	Settable pressure range *6	MPa	0.10 to 0.68	
	Minimum operating flow rate *7	L/min	40	
	Tank capacity	L	60	
	Electric conductivity setting range *8	µS/cm	0.5 to 45	
	Circulating fluid outlet, Circulating fluid return port		Rc1 (Symbol F: G1, Symbol N: NPT1)	
	Tank drain port		Rc3/4 (Symbol F: G3/4, Symbol N: NPT3/4)	
	Automatic fluid fill function (Standard)	Supply side pressure range	MPa	0.2 to 0.5
		Supply side fluid temp. range	°C	5 to 35
		Automatic fluid fill port size	Rc1/2 (Symbol F: G1/2, Symbol N: NPT1/2)	
Over flow port size		Rc1 (Symbol F: G1, Symbol N: NPT1)		
Wetted material		Stainless steel, Copper (Brazing filler metal for the heat exchanger) *9, Brass *9, Bronze *9, PTFE *9, PU *9, FKM, EPDM, PVC, NBR, PE, POM, NR *9, PBT *9, Aluminum oxide ceramic *10, SiC *10, Carbon *10, PP *10		
Electrical system	Power supply		3-phase 380 to 415VAC(50/60Hz) Allowable voltage range ±10%(No continuous voltage fluctuation) 3-phase 460 to 480VAC(60Hz) Allowable voltage range +4%,-10%(Max. voltage less than 500V and no continuous voltage fluctuation)	
	Applicable earth leakage breaker	Rated current	A	40
		Sensitivity current	mA	30
	Rated operating current *5	A	22	
Rated power consumption *5	kW (kVA)	14.3(15.2)		
Noise level (Front: 1m, height: 1m) *5		dB(A)		71
Accessories		Operation manual (for installation/operation) (English 1, Japanese 1) Y strainer (40 mesh) 25A, Barrel nipple 25A, Anchor bracket 2pcs. (including 6 pcs. of M8 bolts) *11		
Weight (in the dry state) *12		kg	Approx.340	

\*1 When the ambient temperature or circulating fluid temperature is 10 °C or below, refer to "3.2.2 Operation at low ambient temperature or low circulating fluid temperature".

\*2 Use fluid for circulating fluid that conforms to:

Clean water: Water Quality Standards of the Japan Refrigeration and Air Conditioning Industry Association (JRA GL-02-1994)

15% ethylene glycol aqueous solution: Diluted with clean water, without any additives such as antiseptics.

DI water (pure water): Electrical conductivity 1 µS/cm or more (electrical resistivity 1MΩ·cm or less)

\*3 (1) Ambient temperature: 32 °C, (2) Circulating fluid: Clean water, (3) Circulating fluid temperature: 20 °C, (4) Circulating fluid flow rate: Rated flow rate, (5) Power supply: 400 VAC

\*4 (1) Ambient temperature: 32 °C, (2) Circulating fluid: Clean water, (3) Circulating fluid flow rate: Rated flow rate  
(4) Power supply: 400 VAC

\*5 (1) Ambient temperature: 32 °C, (2) Circulating fluid: Clean water, (3) Circulating fluid temperature: 20 °C, (4) Load: Refer to the cooling capacity shown in the specification table, (5) Circulating fluid flow rate: Rated flow rate, (6) Power supply: 400 VAC, (7) Piping length: Minimum

\*6 With the pressure control mode that controls the pressure automatically with the inverter. If the pressure control mode is not necessary, use the flow control function or the pump output setting function.

- \*7 Required flow rate to maintain the cooling capacity. When the flow rate is lower than the rated flow, use a by-pass piping set.
- \*8 Option D "With electrical conductivity control" only
- \*9 In the case of option M "Deionized water function", it is not included.
- \*10 Only in the case of option M "Deionized water function", it is included
- \*11 The anchor brackets (including M8 bolt x 6pcs.) are used for fixation with the skid when this product is packed. The anchor bolts are not attached.
- \*12 The weight will increase by 14kg when option A "Caster-adjuster foot installed" is selected.  
 The weight will increase by 1kg when option D "With electrical conductivity control" is selected.  
 The weight will increase by 1kg when option K "Fluid fill port" is selected.

## 8.1.2 Refrigerant with GWP reference

Table 8.1-2 Refrigerant with GWP reference

Refrigerant	Global Warming Potential (GWP)	
	Regulation (EU) No 517/2014 (Based on the IPCC AR4)	Revised Fluorocarbons Recovery and Destruction Law (Japanese law)
R134a	1,430	1,430
R404A	3,922	3,920
R407C	1,774	1,770
R410A	2,088	2,090

Note:

1. This product is hermetically sealed and contains fluorinated greenhouse gases.
2. See specification table for refrigerant used in the product.

## 8.1.3 Communication specifications

- For contact input/output communications, refer to 3.3.4 Contact input/output communication wiring

## 8.2 Dimensions

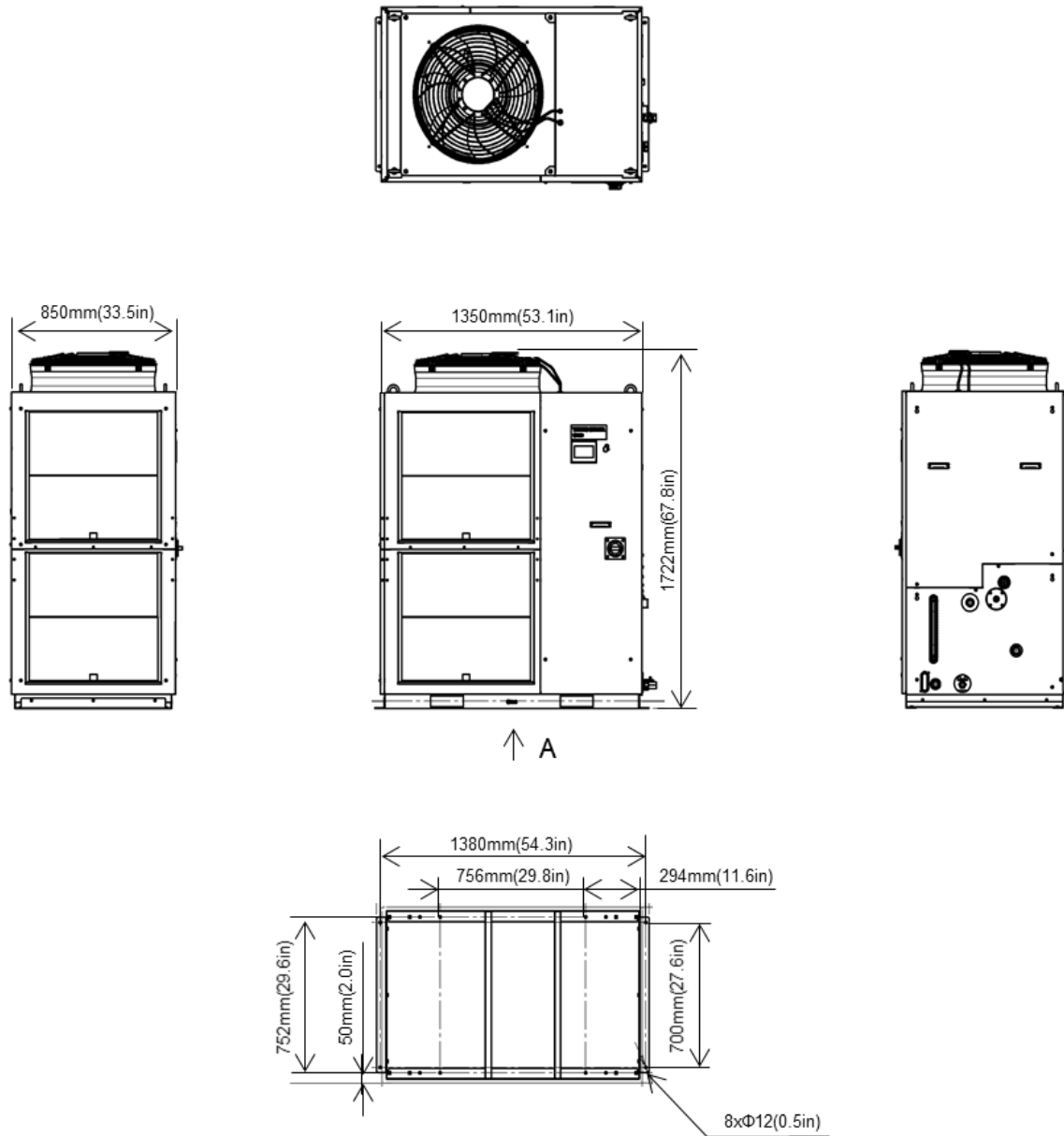

Dimensions for the positions of the anchor bolts (View A)

Fig. 8-1 Dimensions (This drawing shows "HRS400-A-46")

### 8.3 Flow Diagram

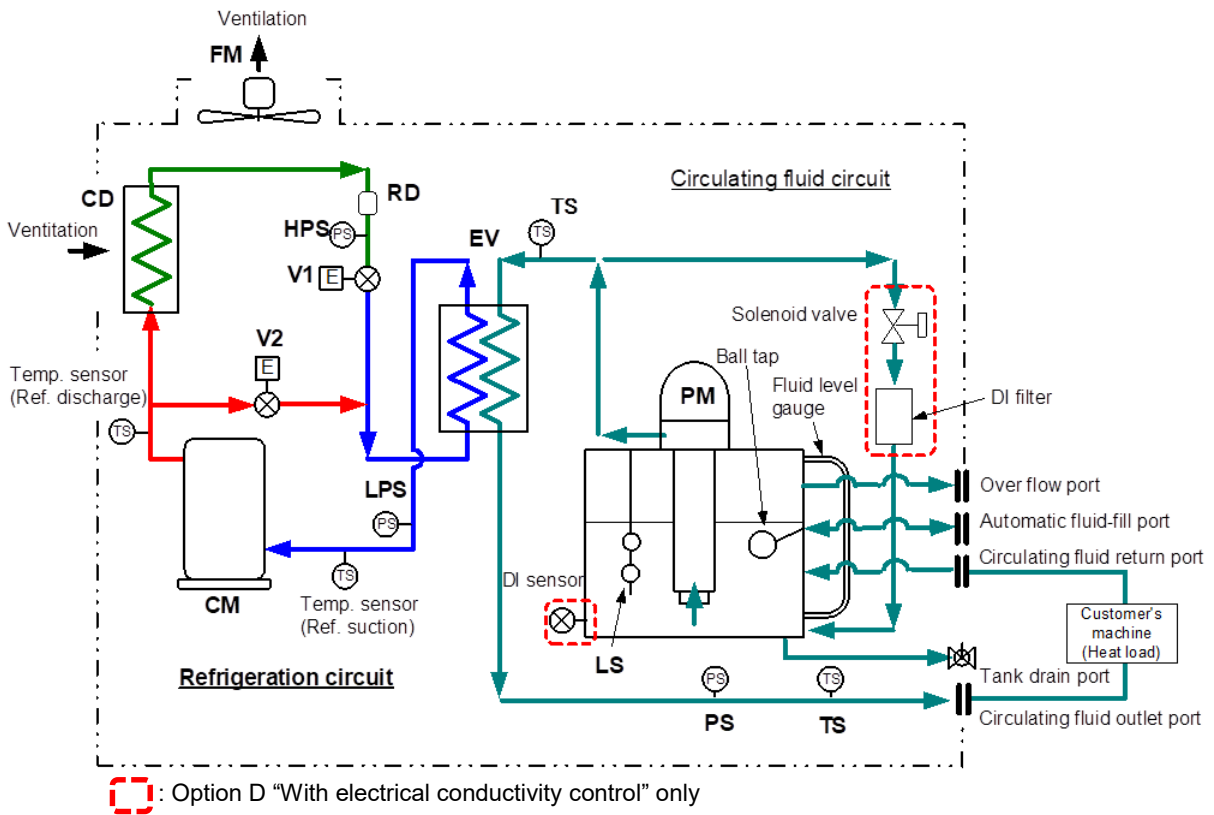

Fig. 8-2 Flow Diagram (HRS400-A\*-46-\*)

## 8.4 Cooling Capacity

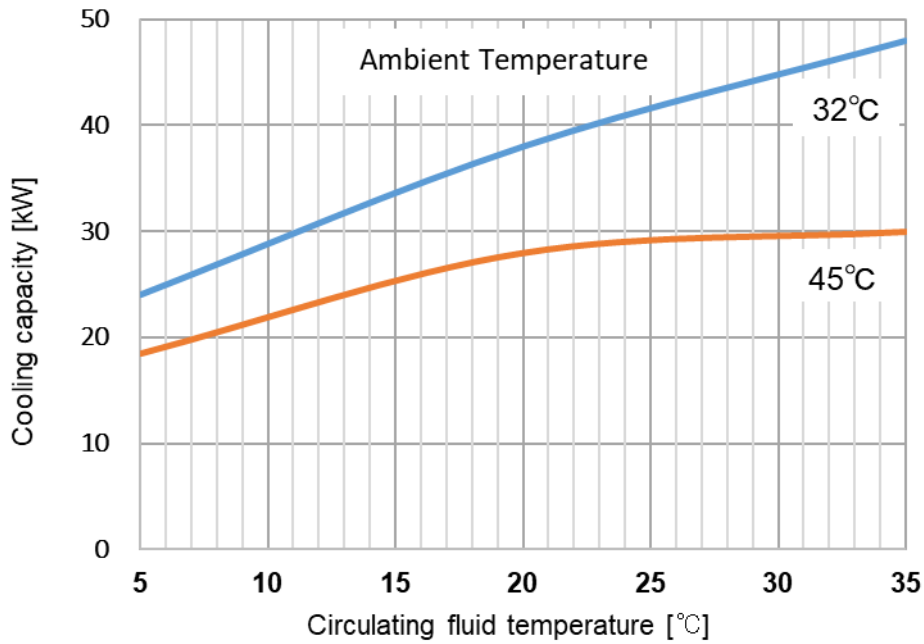

Fig. 8-3 Cooling Capacity (HRS400-A\*-46-\*)

## 8.5 Pump Capacity

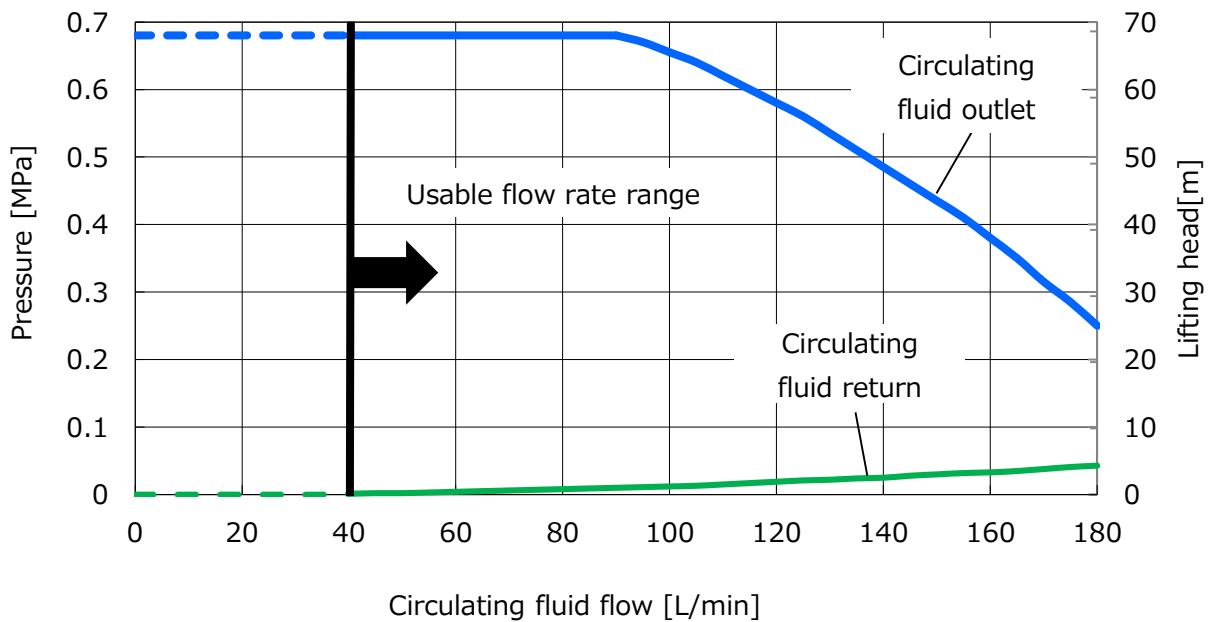



Fig. 8-4 Pump capacity(HRS400-A\*-46-\*)

## 8.6 Types of Hazard Labels



To ensure the safety of the operators, potential hazards are classified and marked with warning labels.

Read this section before starting any work on the product.



### ■ Electric shock warning

 <b>WARNING</b>	
	<p>This symbol stands for danger of electric shock. The product has some uncovered terminals applied with high voltage inside.</p> <ul style="list-style-type: none"><li>● Do NOT operate the product without the cover panels mounted.</li><li>● Do NOT work on the parts inside the product unless you have been trained for the product service.</li><li>● Do NOT work inside this product unless you have been trained to do so.</li></ul>



### ■ High temperature warning

 <b>WARNING</b>	
	<p>This symbol stands for danger of burns. The product has surfaces that can reach high temperatures during operation. Even after the power is turned off, there can still be residual heat in the product., which causes burns.</p> <ul style="list-style-type: none"><li>● Do NOT operate the product without cover panels fitted.</li><li>● Do NOT start working on the parts inside the product until the temperature has decreased sufficiently.</li></ul>

### ■ Rotating objects warning (Air-cooled type only)

 <b>WARNING</b>	
	<p>This symbol stands for a danger of your fingers/hand being cut or getting caught by the rotating objects.</p> <ul style="list-style-type: none"><li>● The product contains a cooling fan that rotates during operation of the product (for air-cooled type). The fan may stop and restart intermittently during operation. Do NOT operate the product without the cover panels mounted.</li></ul>

### ■ Warning related to those other than shown above

 <b>WARNING</b>	
	<p>This symbol stands for a multiplex danger.</p> <p>Electric shock: The product has some uncovered terminals applied with high voltage.</p> <p>Rotary fan: This product has a rotating object inside the cover panel. &lt;Water-cooled refrigerated type&gt;</p> <p>High pressure inside: This product contains high pressure liquid in the piping and the tank.</p> <p>Do not operate the product without the cover panels mounted.</p>

### 8.6.1 Positions of danger warning label

Confirm the positions of the danger warning labels on the product to show the potential danger before starting operation.

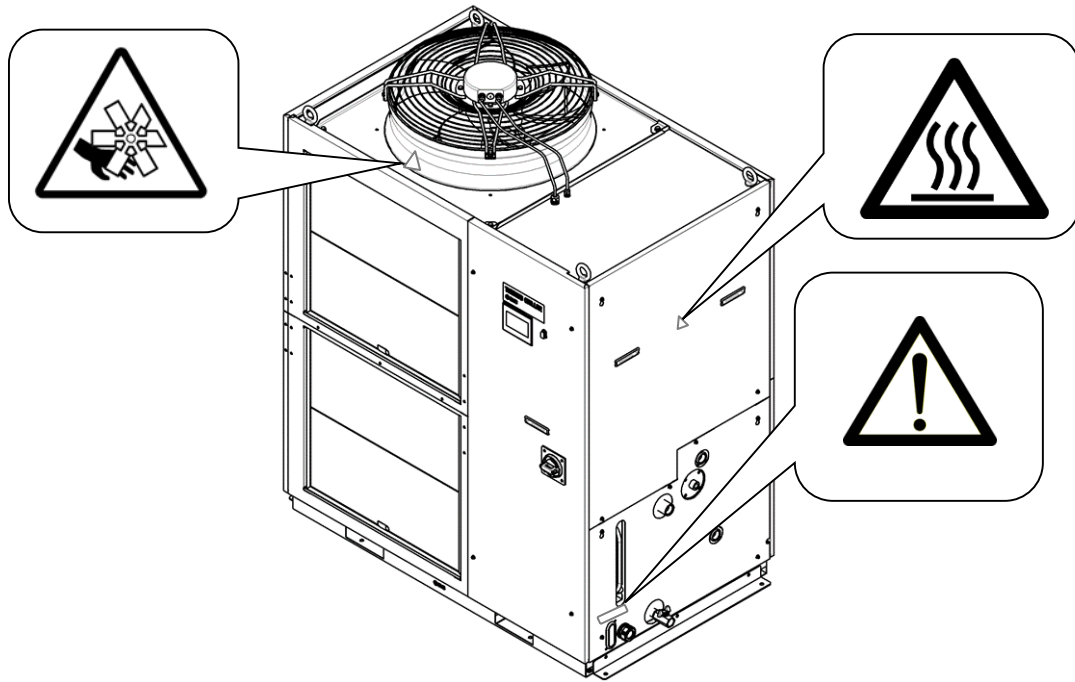

Fig. 8-5 Positions of danger warning label

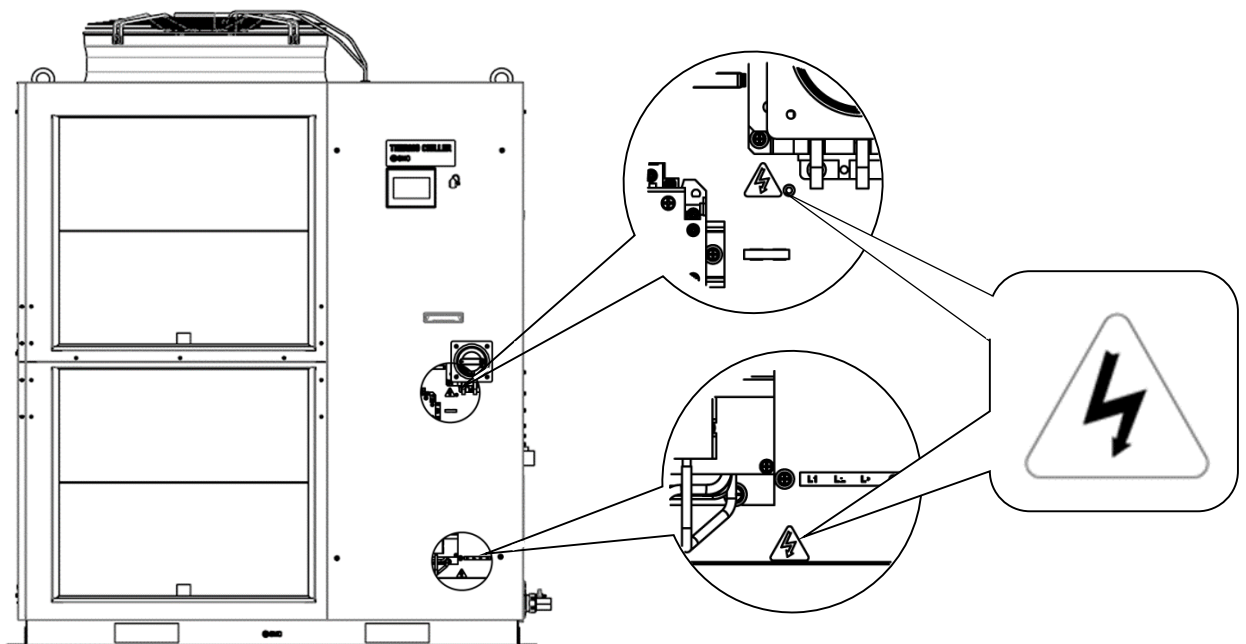

Fig. 8-6 Positions of danger warning label

## 8.7 Standards

This product complies with the standards shown below:

Table 8.7-1 Standards

Standard		
CE Mark	EMC Directive Machinery Directive	2014/30/EU 2006/42/EC
NRTL	E112803(UL61010-1)	







# Chapter 9 Product Warranty

## 1. Period

The warranty period of the product is 1 year in service or 1.5 years after the product is delivered whichever comes first.

## 2. Scope

For any failure reported within the warranty period which is clearly SMC's responsibility, replacement parts will be provided. In that case, removed parts shall become the property of SMC.

This guarantee applies only to SMC's product independently, and not to any other damage incurred due to the failure of the product.

## 3. Contents

1. SMC guarantees that the product will operate normally if it is installed under maintenance and control in accordance with the Operation Manual, and operated under the conditions specified in the catalog or contracted separately.
2. SMC guarantees that the product does not have any defects in components, materials or assembly.
3. SMC guarantees that the product complies with the outline dimensions provided.
4. The following situations are out of scope of this warranty.
  - (1) The product was incorrectly installed or connected with other equipment.
  - (2) The product was under insufficient maintenance and control or incorrectly handled.
  - (3) The product was operated outside of the specifications.
  - (4) The product was modified or altered in construction.
  - (5) The failure was a secondary failure of the product caused by the failure of equipment connected to the product.
  - (6) The failure was caused by a natural disaster such as an earthquake, typhoon, or flood, or by an accident or fire.
  - (7) The failure was caused by operation different from that shown in the Operation Manual or outside of the specifications.
  - (8) The checks and maintenance specified (daily checks and regular checks) were not performed.
  - (9) The failure was caused by the use of circulating fluid or facility water other than those specified.
  - (10) The failure occurred naturally over time (such as discoloration of a painted or plated face).
  - (11) The failure does not affect the functioning of the product (such as new sounds, noises and vibrations).
  - (12) The failure was due to the "Installation Environment" specified in the Operation Manual.
  - (13) The failure was caused by the customer disregarding "6. Request to Customers".

## 4. Agreement

If there is any doubt about anything specified in "2. Scope" and "3. Contents", it shall be resolved by agreement between the customer and SMC.

## 5. Disclaimer

- (1) Expenses for daily and regular checks
- (2) Expenses for repairs performed by other companies
- (3) Expenses for transfer, installation and removal of the product
- (4) Expenses for replacement of parts other than those in this product, or for the supply of liquids
- (5) Inconvenience and loss due to product failure (such as telephone bills, compensation for workplace closure, and commercial losses)
- (6) Expenses and compensation not covered in "2. Scope".

**6. Request to Customers**

Proper use and maintenance are essential to assure safe use of this product. Be sure to satisfy the following preconditions. Please note that SMC may refuse to carry out warranted repair if these preconditions have been disregarded.

- (1) Use the product following the instructions for handling described in the Operation Manual.
- (2) Perform checks and maintenance (daily checks and regular checks) specified in the Operation Manual and Maintenance Manual.
- (3) Record the check and maintenance results on the daily check sheet attached to the Operation Manual and Maintenance Manual.

**7. Request for Warranted Repair**

For warranted repair, please contact the supplier you purchased this product from.

Warranted repair shall be on a request basis.

Repair shall be provided free of charge in accordance with the warranty period, preconditions and terms defined above. Therefore, a fee will be charged for any repairs if a failure is detected after the end of the warranty period.

Revision
----------

## SMC Corporation

4-14-1, Sotokanda, Chiyoda-ku, Tokyo 101-0021 JAPAN

Tel: + 81 3 5207 8249 Fax: +81 3 5298 5362

URL <https://www.smcworld.com>

---

Note: Specifications are subject to change without prior notice and any obligation on the part of the manufacturer.  
© 2022 SMC Corporation All Rights Reserved