



# Operation Manual

PRODUCT NAME

*Clean Air Filter*

MODEL / Series / Product Number

SFD110-\*

**SMC Corporation**

## Contents

Safety Instructions P.2

1. Application P.7

2. Standard specification P.7

3. How to order P.7

4. Construction and Replacement parts P.8

5. Maintenance P.8

6. How to mount P.8

7. Dimensions P.9



# Safety Instructions

These safety instructions are intended to prevent hazardous situations and/or equipment damage. These instructions indicate the level of potential hazard with the labels of “Caution,” “Warning” or “Danger.” They are all important notes for safety and must be followed in addition to International Standards (ISO/IEC)\*1), and other safety regulations.

\*1) ISO 4414: Pneumatic fluid power -- General rules relating to systems.  
 ISO 4413: Hydraulic fluid power -- General rules relating to systems.  
 IEC 60204-1: Safety of machinery -- Electrical equipment of machines .(Part 1: General requirements)  
 ISO 10218: Manipulating industrial robots -Safety.  
 etc.

	<b>Caution</b>	<b>Caution</b> indicates a hazard with a low level of risk which, if not avoided, could result in minor or moderate injury.
	<b>Warning</b>	<b>Warning</b> indicates a hazard with a medium level of risk which, if not avoided, could result in death or serious injury.
	<b>Danger</b>	<b>Danger</b> indicates a hazard with a high level of risk which, if not avoided, will result in death or serious injury.

**Warning**

- 1. The compatibility of the product is the responsibility of the person who designs the equipment or decides its specifications.**  
 Since the product specified here is used under various operating conditions, its compatibility with specific equipment must be decided by the person who designs the equipment or decides its specifications based on necessary analysis and test results.  
 The expected performance and safety assurance of the equipment will be the responsibility of the person who has determined its compatibility with the product.  
 This person should also continuously review all specifications of the product referring to its latest catalog information, with a view to giving due consideration to any possibility of equipment failure when configuring the equipment.
- 2. Only personnel with appropriate training should operate machinery and equipment.**  
 The product specified here may become unsafe if handled incorrectly.  
 The assembly, operation and maintenance of machines or equipment including our products must be performed by an operator who is appropriately trained and experienced.
- 3. Do not service or attempt to remove product and machinery/equipment until safety is confirmed.**
  - 1.The inspection and maintenance of machinery/equipment should only be performed after measures to prevent falling or runaway of the driven objects have been confirmed.
  - 2.When the product is to be removed, confirm that the safety measures as mentioned above are implemented and the power from any appropriate source is cut, and read and understand the specific product precautions of all relevant products carefully.
  3. Before machinery/equipment is restarted, take measures to prevent unexpected operation and malfunction.
- 4. Contact SMC beforehand and take special consideration of safety measures if the product is to be used in any of the following conditions.**
  1. Conditions and environments outside of the given specifications, or use outdoors or in a place exposed to direct sunlight.
  2. Installation on equipment in conjunction with atomic energy, railways, air navigation, space, shipping, vehicles, military, medical treatment, combustion and recreation, or equipment in contact with food and beverages, emergency stop circuits, clutch and brake circuits in press applications, safety equipment or other applications unsuitable for the standard specifications described in the product catalog.
  3. An application which could have negative effects on people, property, or animals requiring special safety analysis.
  - 4.Use in an interlock circuit, which requires the provision of double interlock for possible failure by using a mechanical protective function, and periodical checks to confirm proper operation.



# Safety Instructions

## Caution

### **The product is provided for use in manufacturing industries.**

The product herein described is basically provided for peaceful use in manufacturing industries.

If considering using the product in other industries, consult SMC beforehand and exchange specifications or a contract if necessary.

If anything is unclear, contact your nearest sales branch.

## **Limited warranty and Disclaimer/Compliance Requirements**

The product used is subject to the following “Limited warranty and Disclaimer” and “Compliance Requirements”.

Read and accept them before using the product.

### **Limited warranty and Disclaimer**

1. The warranty period of the product is 1 year in service or 1.5 years after the product is delivered, whichever is first.\*2)

Also, the product may have specified durability, running distance or replacement parts. Please consult your nearest sales branch.

2. For any failure or damage reported within the warranty period which is clearly our responsibility, a replacement product or necessary parts will be provided.

This limited warranty applies only to our product independently, and not to any other damage incurred due to the failure of the product.

3. Prior to using SMC products, please read and understand the warranty terms and disclaimers noted in the specified catalog for the particular products.

\*2) Vacuum pads are excluded from this 1 year warranty.

A vacuum pad is a consumable part, so it is warranted for a year after it is delivered.

Also, even within the warranty period, the wear of a product due to the use of the vacuum pad or failure due to the deterioration of rubber material are not covered by the limited warranty.

### **Compliance Requirements**

1. The use of SMC products with production equipment for the manufacture of weapons of mass destruction (WMD) or any other weapon is strictly prohibited.

2. The exports of SMC products or technology from one country to another are governed by the relevant security laws and regulation of the countries involved in the transaction. Prior to the shipment of a SMC product to another country, assure that all local rules governing that export are known and followed.

## Caution

### **SMC products are not intended for use as instruments for legal metrology.**

Measurement instruments that SMC manufactures or sells have not been qualified by type approval tests relevant to the metrology (measurement) laws of each country.

Therefore, SMC products cannot be used for business or certification ordained by the metrology (measurement) laws of each country.

## Selection



### Warning

- (1) Thoroughly and carefully confirm the purpose of use, required specifications and operating conditions (fluid, pressure, flow rate, nominal filtration rating and environment) then select a model within the specifications.
- (2) The product is not certified under the High Pressure Gas Safety law, so for nitrogen, its maximum operating pressure will be 0.99 MPa (gauge pressure).
- (3) Contact us beforehand if the product will be used in an application such as a caisson shield, breathing, food and/or medical treatment that affects the human body directly or indirectly.
- (4) If the compressed air includes ozone, do not use it since it may damage the product or cause malfunction. When it includes ozone, use a clean gas filter (SFA/B/C).

## Mounting



### Warning

- (1) Operating manual  
Mount the product after reading and understanding the operation manual. Keep it in a location where it can easily be found.
- (2) Flushing  
Flush the piping line when the filter is used for the first time or has been replaced. In the event of connecting such as piping, flush (air blow) when using this product for the first time or replacing its elements in order to reduce the affect of the dust generated from the connection, etc. Flushing the line is also required to eliminate contamination resulting from the piping line installation. Therefore, be sure to flush the line before actually running the system. Fix all mounting parts for use.
- (3) Use fittings with resin threads for the connection of fittings to the IN and OUT ports.  
Using fittings with metal threads could damage the IN and OUT ports.
- (4) Connect tubing to the IN and OUT One-touch fittings in accordance with the precautions for One-touch fittings.



### Caution

- (1) Connect the piping in accordance with the flow direction marked on the case.  
If connected in reverse, the element could break.
- (2) The mounting orientation does not affect the performance, but if excessive force is applied to the product, the body may become disconnected from the bracket.  
Therefore, take particular care about the mounting orientation.

## Caution on Installation



### Warning

- (1) The material of the element is polycarbonate.  
The material is resistant to wiping with alcohol, but is not suitable for atmospheres or places with organic solvents, chemicals, cutting oils, synthetic oils, ester base compressor oils, alkalis or thread locking agents.



### Caution

- (1) If the pressure difference (pressure drop) between the inlet and the outlet exceeds 0.1 MPa, it can cause damage to the product.
- (2) Do not install the product in a place where it can be affected by a pulsation (including surge pressure) of over 0.1 MPa.
- (3) Use caution regarding the particles that may be emitted from the outlet side of a pneumatic equipment.  
Installation of a pneumatic equipment on the outlet side can deteriorate the cleanliness because a particle will be generated from the equipment.  
The mounting position of the pneumatic equipment needs to be considered.
- (4) Set the air flow capacity with an initial pressure drop of 0.03 MPa or less. If the initial pressure drop is set to be high, its service life will be shorten due to clogging.
- (5) Determine the product by the maximum consumption flow rate.  
When using compressed air for an air blow application, calculate the maximum volume of air that will be consumed before selecting.
- (6) Generally, the following pollutant particles are contained in compressed air.  
[Pollutant particle substances contained in the compressed air]
  - Moisture (drainage)
  - Dusts and particles which are in the surrounding air
  - Deteriorated oil which is discharged from the compressor
  - Solid foreign matter such as rust and/or oil in the piping
  - 1) The SFD series is not compatible with compressed air which contains fluids such as water and/or oil.
  - 2) Install a dryer (IDF, IDG, ID series), mist separator (AM series), micro mist separator (AMD series), super mist separator (AME series), or odor removal filter (AMF series), etc., for the source of the air for the SFD series.
- (7) Using with a flow-rate much higher than its specification could lead to exceeding the differential pressure the product can resist.  
Use the product within its specifications. Also, take care about the replacement period of the product, taking into consideration that the differential pressure of the filter will increase over time.

## Piping



### Caution

- (1) Unpacking the sealed package  
Since the filter is sealed in an antistatic double bag, the inner package should be unpacked in a clean atmosphere (such as a clean room).
- (2) Apply a wrench to 2 chamfered flats or hexagon portion on the IN side or the OUT side to prevent the housing from rotating.
- (3) Always tighten threads with the proper tightening torque.  
When attaching fittings to the product, tighten with the proper tightening torque (2 to 3 N · m).
- (4) Check the arrow mark on the case which shows the flow direction to connect the IN and OUT ports correctly.  
If connected in reverse, the element could break.

## Maintenance



### Warning

- (1) Follow the maintenance procedures in the operation manual. If handled incorrectly equipment or device can be damaged or cause a malfunction.
- (2) When removing the product, exhaust the air and ensure the air is released to atmosphere before removing it.
- (3) When the element comes to the end of its life, immediately replace it with a new filter.  
Service life of element  
The service life of the element ends when either of the following two conditions occurs.
  - 1) After 1 year of usage has elapsed.
  - 2) When the pressure drop reaches 0.1 MPa even though the operating period has been less than 1 year.

## Operating Environment



### Warning

- (1) Do not operate under the conditions listed below due to a risk of malfunction.
  - In locations having corrosive gases, organic solvents, and chemical solutions, or in locations in which these elements are likely to adhere to the equipment.
  - In locations in which salt water, water, or water vapor could come in contact with the equipment.
  - In locations that are exposed to direct sunlight. (Shield the equipment from sunlight to prevent its resin material from ultraviolet ray degradation or overheating.)
  - In locations that have a heat source and poor ventilation. (Shield the equipment from heat sources to protect it from softening degradation due to radiated heat.)
  - In locations that are exposed to shocks and vibrations.
  - In locations with high humidity or a large amounts of dust.
- (2) When the product is used for blowing, use caution to prevent the work from being damaged by entrained air from the surrounding area.
  - When the compressed air is used for air blow, the exhausted air from the blow nozzle may have taken in airborne foreign matter (such as solid particle, fluid particle) from the surround air. The foreign matter will be sprayed on the work, and the airborne foreign matter may adhere to it. Therefore, use caution for the surrounding environment.

## Other Tube Brands



### Warning

- (1) When tubing of brands other than SMC's are used, verify that the tubing O.D. satisfies the following accuracy;
  - 1) Polyolefin tube: Within  $\pm 0.1$  mm
  - 2) Polyurethane tubing: Within  $+0.15$  mm, within  $-0.2$  mm
  - 3) Nylon tubing: Within  $\pm 0.1$  mm
  - 4) Soft nylon tubing: Within  $\pm 0.1$  mm
  - Do not use tubing which does not meet these outside diameter tolerances. It may not be possible to connect them, or they may cause other trouble, such as air leakage or the tube pulling out after connection.
  - The recommended tube for the clean fitting is polyolefin tube. Other tubes can satisfy the performance in terms of leakage, tensile strength, etc., but impair the cleanliness. Note this point for use.

### 1. Application

This product aims at eliminating solid foreign matter in the air line.

### 2. Standard specification

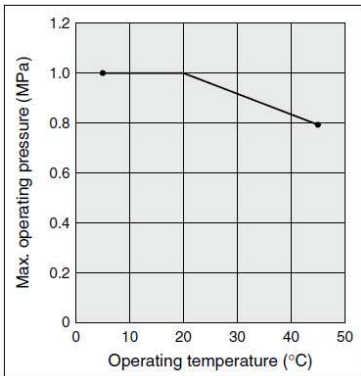
Model	<b>SFD110</b>
Port size	One-touch fittings φ 4, φ 6, φ 8
	Rc, NPT, G1/4
Air flow capacity	Up to 120L/min(ANR)
Fluid	Air, Nitrogen
Nominal filtration rating <sup>Note1)</sup>	0.01μm(filtration accuracy 99.99%)
Operating pressure range <sup>Note2)</sup>	-100kPa to 1.0MPa (In case of Nitrogen: 0.99MPa)
	 <p>Relationship between Operating Temperature and Max. Operating Pressure</p>
Operating temperature	5 to 45°C
Initial pressure drop	Less than 0.03MPa (at inlet pressure 0.7MPa, maximum flow)
Element proof differential pressure <sup>Note3)</sup>	0.5MPa
Proof pressure	1.5MPa
Element service life	1 year, or when the pressure drop reaches 0.1MPa.

### 3. How to order

SFD 1 1 0 - C08 □

●Option

Symbol	Option
Nil	None
B	Bracket

●Port size

Symbol	Connection size
C04	φ4
C06	φ6
C08	φ8
02	Rc1/4
N02	NPT1/4
F02	G1/4

Clean One-touch fittings (KP series)



## 4. Construction and Replacement parts

SFD110-C\*\*

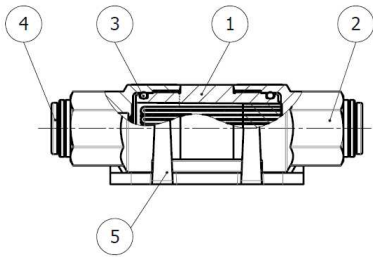

SFD110-\*02\*

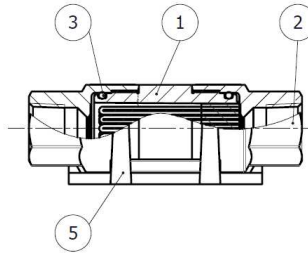

### Component Parts

No.	Description	Material
1	Element	—
2	Cover	PBT
3	O-ring	HNBR
4	Clean One-touch fittings	PP, EPDM, Stainless steel
5	Bracket	PBT

### Replacement Parts

No.	Description	Material	Note
1	Bracket set	SFD-BR100	With 2 countersunk head screw (M3)

## 5. Maintenance

The element of this product cannot be disassembled or replaced. It is therefore necessary to replace the entire housing to replace the element.

<Time to replace the filter body or element >

The service life of the element ends when either of the following two conditions occurs.

- 1) After 1 year of usage has elapsed.
- 2) When the pressure drop reaches 0.1 MPa even though the operating period has been less than 1 year.

## 6. How to mount

- Check which side is IN · OUT before connecting. The direction of IN and OUT must follow the arrow marking on the product housing.

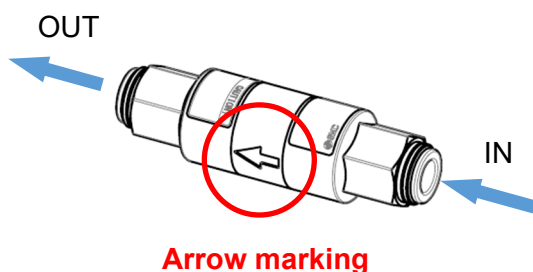

- Ensure that each sealing part does not leak.
- Keep a space to remove the element for maintenance.
- Follow the instructions for the one-touch fitting to connect and disconnect tubing.

## 7. Dimensions

### SFD110-C\*\*

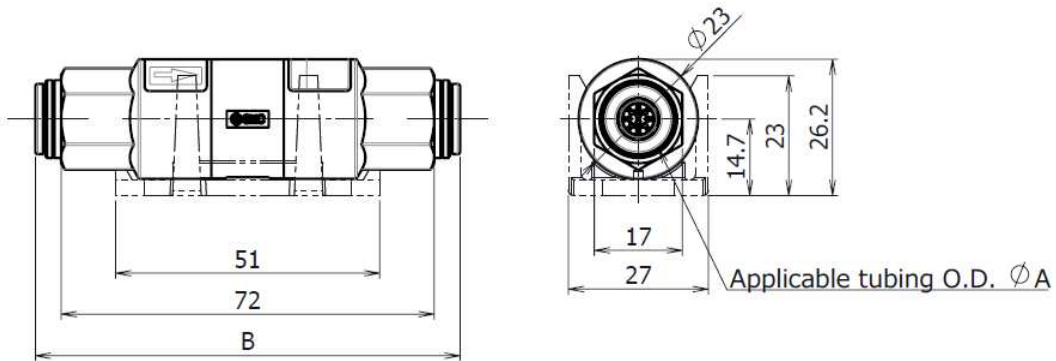

SFD110-C\*\* dimensions

Model		A	B
SFD110-	C04	4	81
	C06	6	81
	C08	8	82

### SFD110-\*02\*

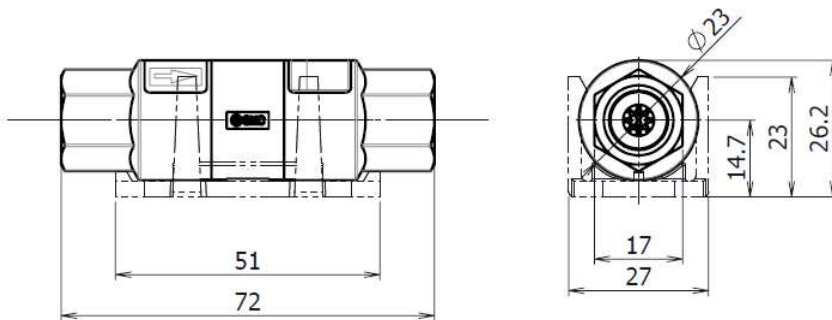

Bracket mounting dimensions

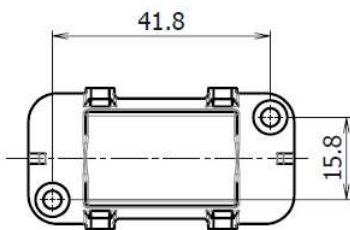

Hole shape for bracket mounting

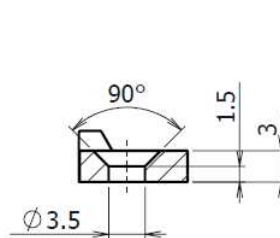

\*Use a countersunk head screw (M3) for bracket mounting

Revision history
------------------

## SMC Corporation

4-14-1, Sotokanda, Chiyoda-ku, Tokyo 101-0021 JAPAN  
Tel: + 81 3 5207 8249 Fax: +81 3 5298 5362  
URL <https://www.smcworld.com>