



# Operation Manual

PRODUCT NAME

SI unit  
(CC-Link compatible)

MODEL / Series / Product Number

*EX260-SMJ#*

**SMC Corporation**

## Table of Contents

Safety Instructions	2
Model Indication and How to Order	8
Summary of Product elements	9
Installation and Wiring	10
Installation	10
Wiring	11
LED Indication and Settings	16
Troubleshooting and Maintenance	21
Specifications	26
Specifications	26
Dimensions	27
Accessories	28



# Safety Instructions

These safety instructions are intended to prevent hazardous situations and/or equipment damage. These instructions indicate the level of potential hazard with the labels of "Caution", "Warning" or "Danger". They are all important notes for safety and must be followed in addition to International Standards (ISO/IEC)\*1), and other safety regulations.

\*1) ISO 4414: Pneumatic fluid power -- General rules relating to systems.

ISO 4413: Hydraulic fluid power -- General rules relating to systems.

IEC 60204-1: Safety of machinery -- Electrical equipment of machines .(Part 1: General requirements)

ISO 10218: Manipulating industrial robots -Safety.

etc.



## Caution

**Caution** indicates a hazard with a low level of risk which, if not avoided, could result in minor or moderate injury.



## Warning

**Warning** indicates a hazard with a medium level of risk which, if not avoided, could result in death or serious injury.



## Danger

**Danger** indicates a hazard with a high level of risk which, if not avoided, will result in death or serious injury.

## Warning

### 1. The compatibility of the product is the responsibility of the person who designs the equipment or decides its specifications.

Since the product specified here is used under various operating conditions, its compatibility with specific equipment must be decided by the person who designs the equipment or decides its specifications based on necessary analysis and test results.

The expected performance and safety assurance of the equipment will be the responsibility of the person who has determined its compatibility with the product.

This person should also continuously review all specifications of the product referring to its latest catalog information, with a view to giving due consideration to any possibility of equipment failure when configuring the equipment.

### 2. Only personnel with appropriate training should operate machinery and equipment.

The product specified here may become unsafe if handled incorrectly.

The assembly, operation and maintenance of machines or equipment including our products must be performed by an operator who is appropriately trained and experienced.

### 3. Do not service or attempt to remove product and machinery/equipment until safety is confirmed.

1. The inspection and maintenance of machinery/equipment should only be performed after measures to prevent falling or runaway of the driven objects have been confirmed.

2. When the product is to be removed, confirm that the safety measures as mentioned above are implemented and the power from any appropriate source is cut, and read and understand the specific product precautions of all relevant products carefully.

3. Before machinery/equipment is restarted, take measures to prevent unexpected operation and malfunction.

### 4. Contact SMC beforehand and take special consideration of safety measures if the product is to be used in any of the following conditions.

1. Conditions and environments outside of the given specifications, or use outdoors or in a place exposed to direct sunlight.

2. Installation on equipment in conjunction with atomic energy, railways, air navigation, space, shipping, vehicles, military, medical treatment, combustion and recreation, or equipment in contact with food and beverages, emergency stop circuits, clutch and brake circuits in press applications, safety equipment or other applications unsuitable for the standard specifications described in the product catalog.

3. An application which could have negative effects on people, property, or animals requiring special safety analysis.

4. Use in an interlock circuit, which requires the provision of double interlock for possible failure by using a mechanical protective function, and periodical checks to confirm proper operation.



# Safety Instructions

## Caution

### **1. The product is provided for use in manufacturing industries.**

The product herein described is basically provided for peaceful use in manufacturing industries. If considering using the product in other industries, consult SMC beforehand and exchange specifications or a contract if necessary.  
If anything is unclear, contact your nearest sales branch.

## **Limited warranty and Disclaimer/Compliance Requirements**

The product used is subject to the following "Limited warranty and Disclaimer" and "Compliance Requirements".

Read and accept them before using the product.

### **Limited warranty and Disclaimer**

**1. The warranty period of the product is 1 year in service or 1.5 years after the product is delivered, whichever is first.\*2)**

Also, the product may have specified durability, running distance or replacement parts. Please consult your nearest sales branch.

**2. For any failure or damage reported within the warranty period which is clearly our responsibility, a replacement product or necessary parts will be provided.**

This limited warranty applies only to our product independently, and not to any other damage incurred due to the failure of the product.

**3. Prior to using SMC products, please read and understand the warranty terms and disclaimers noted in the specified catalog for the particular products.**

**\*2) Vacuum pads are excluded from this 1 year warranty.**

A vacuum pad is a consumable part, so it is warranted for a year after it is delivered.

Also, even within the warranty period, the wear of a product due to the use of the vacuum pad or failure due to the deterioration of rubber material are not covered by the limited warranty.

### **Compliance Requirements**

**1. The use of SMC products with production equipment for the manufacture of weapons of mass destruction (WMD) or any other weapon is strictly prohibited.**

**2. The exports of SMC products or technology from one country to another are governed by the relevant security laws and regulation of the countries involved in the transaction. Prior to the shipment of a SMC product to another country, assure that all local rules governing that export are known and followed.**

## Operator

- ◆ This operation manual is intended for those who have knowledge of machinery using pneumatic equipment, and have sufficient knowledge of assembly, operation and maintenance of such equipment. Only those persons are allowed to perform assembly, operation and maintenance.
- ◆ Read and understand this operation manual carefully before assembling, operating or providing maintenance to the product.

### ■ Safety Instructions

#### **Warning**

- Do not disassemble, modify (including changing the printed circuit board) or repair.  
Do not use the components other than the specified components.  
An injury or failure can result.
- Do not operate the product outside of the specifications.  
Do not use for flammable or harmful fluids.  
Fire, malfunction, or damage to the product can result.  
Verify the specifications before use.
- Do not operate in an atmosphere containing flammable or explosive gases.  
Fire or an explosion can result.  
This product is not designed to be explosion proof.
- If using the product in an interlocking circuit:
  - Provide a double interlocking system, for example a mechanical system.
  - Check the product regularly for proper operation.Otherwise malfunction can result, causing an accident.
- The following instructions must be followed during maintenance:
  - Turn off the power supply.
  - Stop the air supply, exhaust the residual pressure and verify that the air is released before performing maintenance.Otherwise an injury can result.

#### **Caution**

- After maintenance is complete, perform appropriate functional inspections.  
Stop operation if the equipment does not function properly.  
Safety cannot be assured in the case of unexpected malfunction.
- Provide grounding to assure the noise resistance of the Fieldbus system.  
Individual grounding should be provided close to the product with a short cable.

## ■NOTE

- Follow the instructions given below when designing, selecting and handling the product.
- The instructions on design and selection (installation, wiring, environment, adjustment, operation, maintenance, etc.) described below must also be followed.
  - \*Product specifications
    - When conformity to UL is required, the SI unit should be used with a UL1310 Class 2 power supply.
    - The SI unit is a UL approved product only if they have a  mark on the body.
    - Use the specified voltage.  
Otherwise failure or malfunction can result.
    - Reserve a space for maintenance.  
Allow sufficient space for maintenance when designing the system.
    - Do not remove any nameplates or labels.  
This can lead to incorrect maintenance, or misreading of the operation manual, which could cause damage or malfunction to the product.  
It may also result in non-conformity to safety standards.

## ●Product handling

### \*Installation

- Do not drop, hit or apply excessive shock to the fieldbus system.  
Otherwise damage to the product can result, causing malfunction.
- Tighten to the specified tightening torque.  
If the tightening torque is exceeded the mounting screws may be broken.  
IP67 protection cannot be guaranteed if the screws are not tightened to the specified torque.
- Never mount a product in a location that will be used as a foothold.  
The product may be damaged if excessive force is applied by stepping or climbing onto it.

### \*Wiring

- Avoid repeatedly bending or stretching the cables, or placing heavy load on them.  
Repetitive bending stress or tensile stress can cause breakage of the cable.
- Wire correctly.  
Incorrect wiring can break the product.
- Do not perform wiring while the power is on.  
Otherwise damage to the fieldbus system and/or I/O device can result, causing malfunction.
- Do not route wires and cables together with power or high voltage cables.  
Otherwise the fieldbus system and/or I/O device can malfunction due to interference of noise and surge voltage from power and high voltage cables to the signal line.  
Route the wires (piping) of the fieldbus system and/or I/O device separately from power or high voltage cables.
- Confirm proper insulation of wiring.  
Poor insulation (interference from another circuit, poor insulation between terminals, etc.) can lead to excess voltage or current being applied to the product, causing damage.
- Take appropriate measures against noise, such as using a noise filter, when the fieldbus system is incorporated into equipment.  
Otherwise noise can cause malfunction.
- Separate the power line for output devices from the power line for control.  
Otherwise noise or induced surge voltage can cause malfunction.

### \*Environment

- Select the proper type of protection according to the environment of operation.  
IP67 protection is achieved when the following conditions are met.
  - (1) The units are connected properly with fieldbus cable with M12 connector and power cable with M12 (M8) connector.
  - (2) Suitable mounting of each unit and manifold valve.If using in an environment that is exposed to water splashes, please take measures such as using a cover.
- Do not use in a place where the product could be splashed by oil or chemicals.  
If the product is to be used in an environment containing oils or chemicals such as coolant or cleaning solvent, even for a short time, it may be adversely affected (damage, malfunction etc.).
- Do not use the product in an environment where corrosive gases or fluids could be splashed.  
Otherwise damage to the product and malfunction can result.
- Do not use in an area where surges are generated.  
If there is equipment which generates a large amount of surge (solenoid type lifter, high frequency induction furnace, motor, etc.) close to the fieldbus system, this may cause deterioration or breakage of the internal circuit of the fieldbus system. Avoid sources of surge generation and crossed lines.
- When a surge-generating load such as a relay or solenoid is driven directly, use an fieldbus system with a built-in surge absorbing element.  
Direct drive of a load generating surge voltage can damage the fieldbus system.
- The product is CE marked, but not immune to lightning strikes. Take measures against lightning strikes in the system.
- Prevent foreign matter such as remnant of wires from entering the fieldbus system to avoid failure and malfunction.

- Mount the product in a place that is not exposed to excessive vibration or impact.  
Otherwise failure or malfunction can result.
- Do not use the product in an environment that is exposed to temperature cycle.  
Heat cycles other than ordinary changes in temperature can adversely affect the inside of the product.
- Do not expose the product to direct sunlight.  
If using in a location directly exposed to sunlight, shade the product from the sunlight.  
Otherwise failure or malfunction can result.
- Keep within the specified ambient temperature range.  
Otherwise malfunction can result.
- Do not operate close to a heat source, or in a location exposed to radiant heat.  
Otherwise malfunction can result.

\*Adjustment and Operation

- Perform settings suitable for the operating conditions.  
Incorrect setting can cause operation failure.
- Please refer to the PLC manufacturer's manual etc. for details of programming and addresses.  
For the PLC protocol and programming refer to the relevant manufacturer's documentation.

\*Maintenance

- Turn off the power supply, stop the supplied air, exhaust the residual pressure and verify the release of air before performing maintenance.  
There is a risk of unexpected malfunction.
- Perform regular maintenance and inspections.  
There is a risk of unexpected malfunction.
- After maintenance is complete, perform appropriate functional inspections.  
Stop operation if the equipment does not function properly.  
Otherwise safety is not assured due to an unexpected malfunction or incorrect operation.
- Do not use solvents such as benzene, thinner etc. to clean the each unit.  
They could damage the surface of the body and erase the markings on the body.  
Use a soft cloth to remove stains.  
For heavy stains, use a cloth soaked with diluted neutral detergent and fully squeezed, then wipe up the stains again with a dry cloth.
- The connecting part of the display window or modules assumes its mounting and removal only for initial setting and removal for maintenance. Daily or frequent mounting and removal may deteriorate the IP rating.



# Model Indication and How to Order

EX260-SMJ 1

- Connector type, output specification

1	M12 connector, 32 outputs, PNP (negative common) / source
2	M12 connector, 32 outputs, NPN (positive common) / sink
3	M12 connector, 16 outputs, PNP (negative common) / source
4	M12 connector, 16 outputs, NPN (positive common) / sink

- Fieldbus

MJ	CC-Link
----	---------

## Summary of Product elements

<EX260-SMJ1/-SMJ2/-SMJ3/-SMJ4>

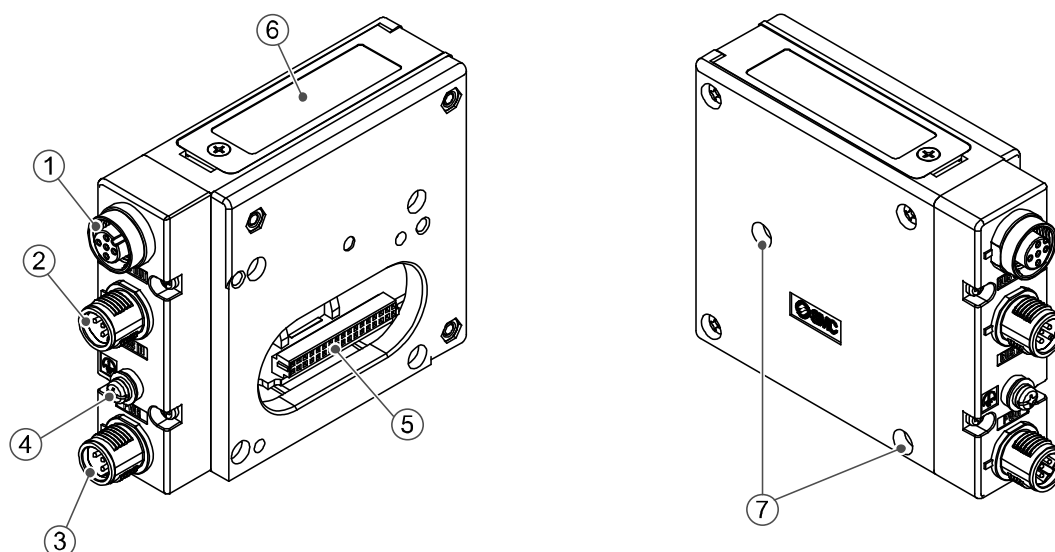

No.	Element	Description
1	Fieldbus interface connector (BUS OUT)	CC-Link connection PORT 2. *1 (M12 5-pin socket, A-coded)
2	Fieldbus interface connector (BUS IN)	CC-Link connection PORT 1. *1 (M12 4-pin plug, A-coded)
3	Power supply connector	Power supply with load voltage for valves and operating voltage for SI unit. *1 (M12 5-pin plug, B-coded)
4	FE terminal	Functional earth. (M3 screw)
5	Output connector	Output signal interface for valve manifold.
6	LED and switch	LED display to indicate the status of the SI unit *2
7	Mounting hole	Mounting hole for connection to the valve manifold.

### Accessories

Hexagon socket head cap screw	2 pcs. M3 x 30 screw for connection to the valve manifold.
Seal cap	1 pc. seal cap for unused fieldbus interface connector (BUS OUT).

\*1: Refer to page 28 for applicable connector cables.

\*2: Refer to page 16 for the LED Indication and Settings.

# Installation and Wiring

## ■ Installation

Connect valve manifold to the SI unit.

### • Dimensions for installation

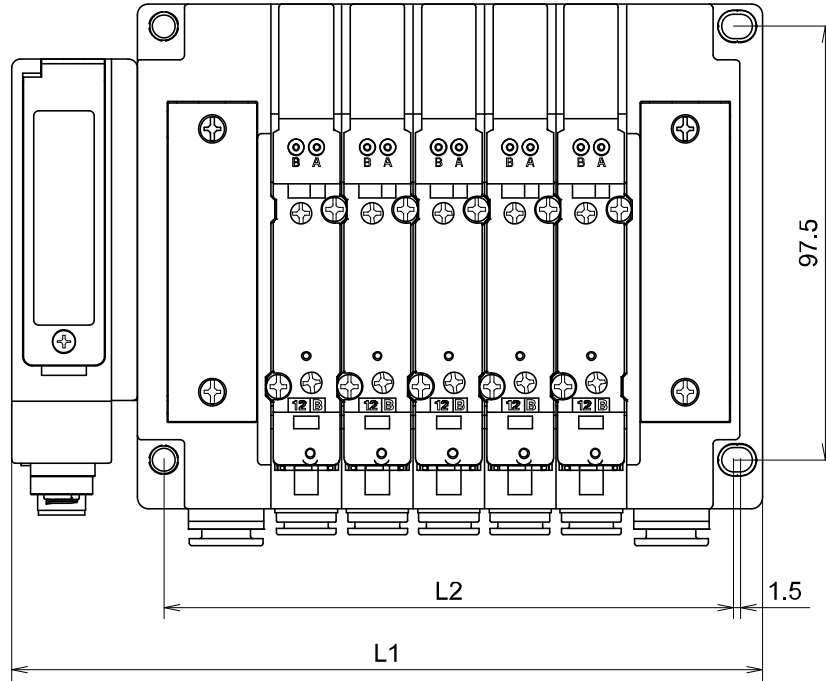

n: number of valve stations

L \ n	1	2	3	4	5	6	7	8	
L1		120.7	136.7	152.7	168.7	184.7	200.7	216.7	
L2		80	96	112	128	144	160	176	
L \ n	9	10	11	12	13	14	15	16	
L1		232.7	248.7	264.7	280.7	296.7	312.7	328.7	344.7
L2		192	208	224	240	256	272	288	304

(mm)

The above table shows dimensions as an example for the SY5000 series valve manifold.

Connectable valve manifolds are the same as for EX250 series SI unit.

Refer to the EX250 series valve manifold section in the valve catalogue for valve manifold dimensions.

## ■Wiring

Select the appropriate cables to mate with the connectors mounted on the SI unit.  
Refer to Accessories (page 28).

### ○Fieldbus interface connector layout

#### BUS OUT: M12 5-pin socket, A-coded \* (SPEEDCON)

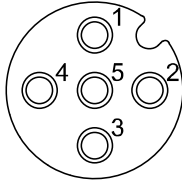

No.	Designation	Description
1	SLD	Shield
2	DB	Communication wire DB
3	DG	Communication wire DG
4	DA	Communication wire DA
5	-	Unused

\*: Recommended mating M12 4-pin plug, part no. PCA-1567717.  
(Refer to page 28)

#### BUS IN: M12 4-pin plug, A-coded (SPEEDCON)

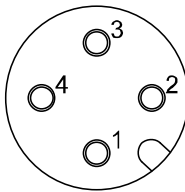

No.	Designation	Description
1	SLD	Shield
2	DB	Communication wire DB
3	DG	Communication wire DG
4	DA	Communication wire DA

The M12 connector cable has two types, SPEEDCON compatible and non-compatible. If both plug and socket sides have connectors for SPEEDCON, the cable can be inserted and connected by turning it a 180° of a rotation, leading to reduction in work hour.  
A non-compatible connector can be connected to a compatible connector as well as an M12.

Connect the "BUS IN" connector to the upstream device (PLC etc.) and connect the "BUS OUT" connector to the downstream device.

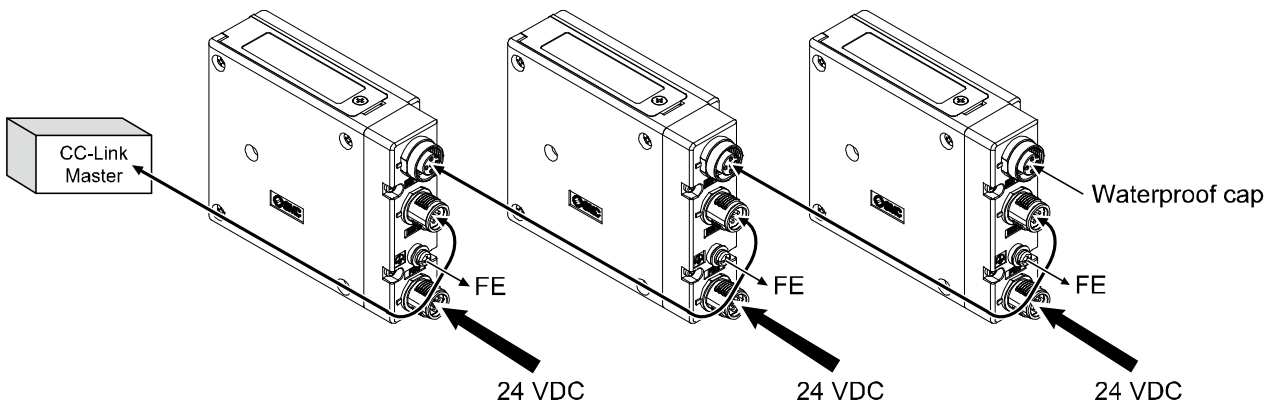

#### Note

- Be sure to fit a seal cap on any unused connectors.  
Proper use of the seal cap enables the enclosure to achieve IP67 specification.

\*: Refer to page 32 for the seal cap.

○Terminating resistor

The terminating resistor to be connected to the CC-Link network depends on the type of cables used. Please refer to the table below.

Cable type	Terminating resistor	
Communication cable for CC-Link With socket for BUS IN - PCA-1567720 With plug for BUS OUT - PCA-1567717	110 Ω 1/2 W	Built-in terminating resistor 110 Ω Set the SI unit DIP Switch-No.2 to ON
CC-Link Ver.1.00 dedicated High-performance cable	130 Ω 1/2 W	N/A

**Note**

•Use the internal terminating resistor only when the SI unit is placed at the end of the CC-Link main line.

An external terminating resistor should not be used when the internal resistor is used.

The terminating resistor value will be outside the specified range. A network communication error may occur.

\*: Refer to page 17 for the switch settings.

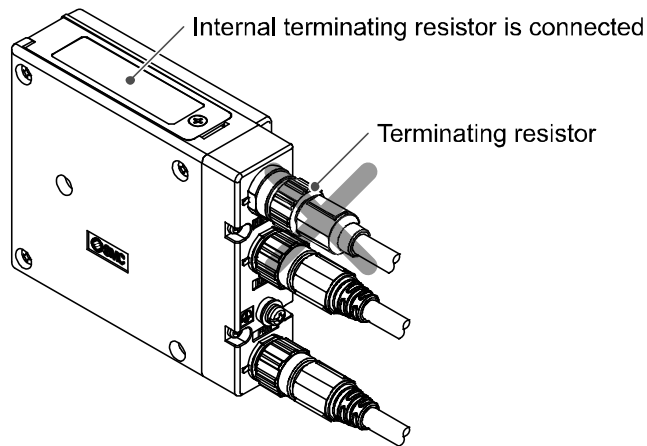

**Note**

•When the CC-Link Ver.1.00 dedicated High-performance cable is used, disable the internal terminating resistor switch and connect a 130 Ω terminating resistor to the BUS OUT connector.

○Power supply connector layout

PWR: M12 5-pin plug, B-coded (SPEEDCON)

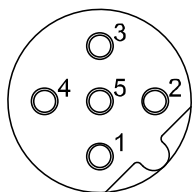

No.	Designation	Description
1	SV24 V	+24 V for solenoid valve
2	SV0 V	0 V for solenoid valve
3	SI24 V	+24 V for SI unit operation
4	SI0 V	0 V for SI unit operation
5	-	Unused

The M12 connector cable has two types, SPEEDCON compatible and non-compatible. If both plug and socket sides have connectors for SPEEDCON, the cable can be inserted and connected by turning it a 1/2 of a rotation, leading to reduction in work hour.  
A non-compatible connector can be connected to a compatible connector as well as an M12.

Power-supply line for solenoid valve and power-supply line for SI unit operation are isolated.  
Be sure to supply power, respectively.  
Either a single- power source or two different power supplies can be used.  
Refer to page 28 for details of the power supply cable and wire colours.

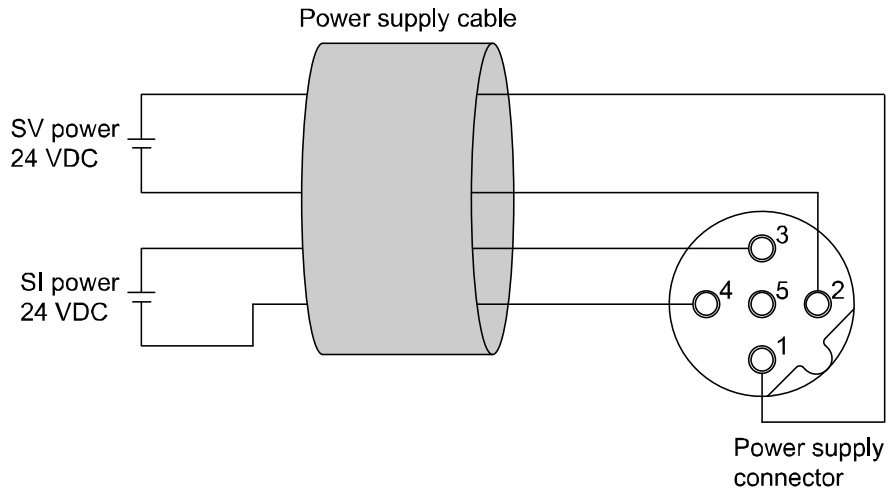

A. Two different power supply

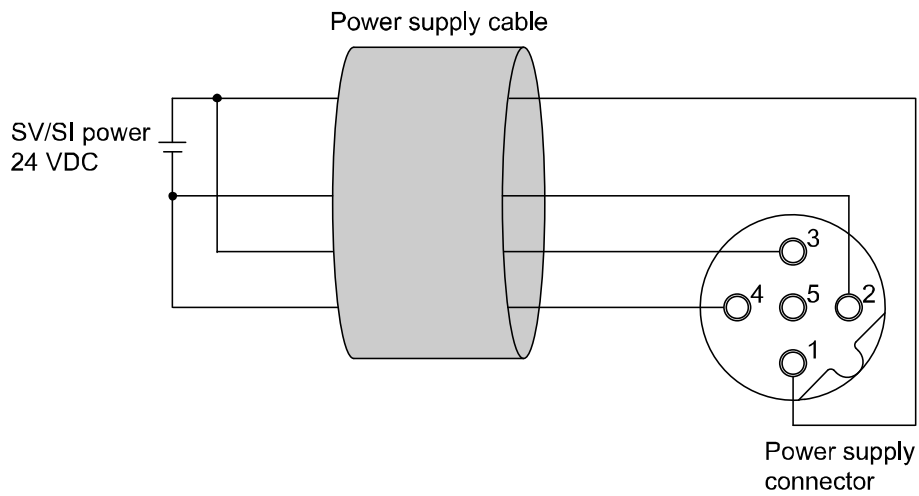

B. Single-source power supply

\*: Pay attention not to exceed the tolerance range of power supply voltage.

○FE terminal

Connect the FE terminal to ground.

Resistance to ground should be 100 ohms or less.

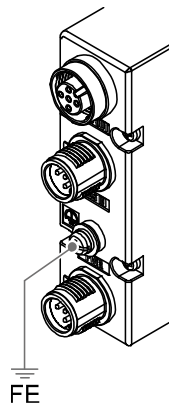





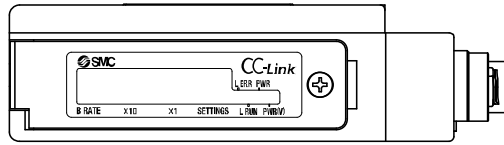





## LED Indication and Settings



### LED indication



L ERR L RUN PWR PWR(V)

LED	LED Status	Description
L ERR	 Red ON	Communication error
	 Red flashing	The station number and baud rate settings have been changed during communication
	 OFF	Communication is normal
L RUN	 Green ON	Communication is normal
	 OFF	Communication has terminated (time out error)
PWR	 Green ON	Power supply for SI unit is ON
	 OFF	Power supply for SI unit is OFF
PWR(V)	 Green ON	Power supply for solenoid valves is ON
	 OFF	Power supply for solenoid valves is OFF

○Switch setting

The switches should only be set with the power supply turned off.

Open the cover and set the rotary switches and DIP switch with a small flat blade screwdriver.  
After setting the switch, close the cover and tighten the cover screw. (0.2 N•m)

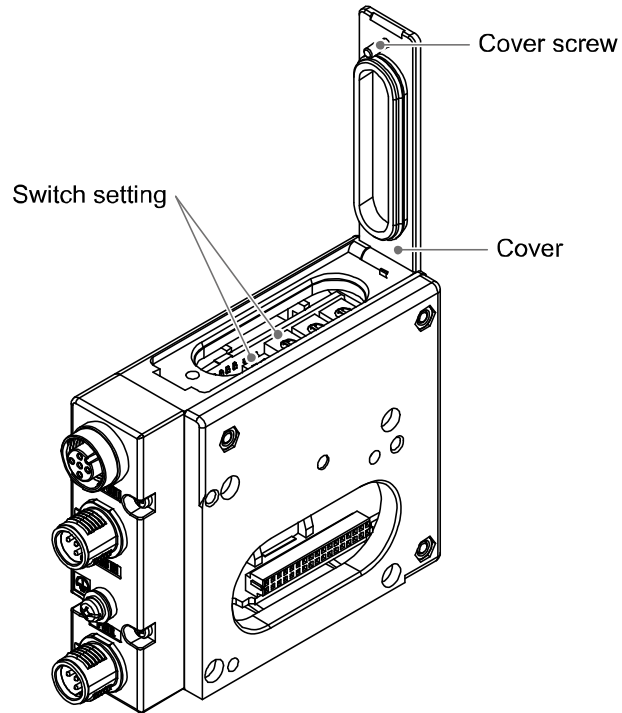

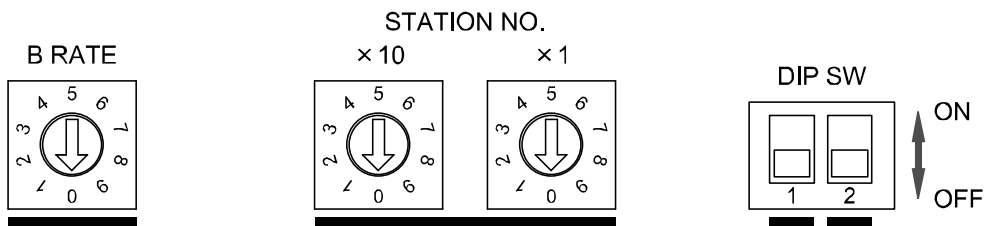

• Baud rate setting

Baud rate	Setting
156 kbps	0
625 kbps	1
2.5 Mbps	2
5 Mbps	3
10 Mbps	4

\*: If the baud rate is set to a number above 4, the "L ERR" LED will turn on.

• Setting the Number of occupied stations

Setting		Station No.
x10	x1	
0	0	Error (Default setting)
0	1	1
0	2	2
:	:	:
6	3	63
6	4	64

\*: If the number of occupied stations is set to 00 or a number above 64, the "L ERR" LED will turn on.

• HOLD/CLEAR setting

HOLD/CLEAR	No.1	Description
HOLD	ON	Hold the last state before communication error.
CLEAR	OFF	Clear all outputs.

• Setting terminating resistor

Terminating resistor	No.2	Description
Enable	ON	Connect the internal terminating resistor (110 Ω).
Disable	OFF	Disconnect the internal terminating resistor.

○Output information

**I/O mapping table for master station Buffer Memory.**

EX260-SMJ□ is a remote I/O station (1 station occupied, 32 inputs/32 outputs).  
An example of when the SI unit station number is set to 01 is shown below.

Master station buffer area  
e.g.: "QJ61BT11N"

Node number	Buffer memory address	Remote input (RX)	Buffer memory address	Remote output (RY)
1	E0H	RX0F to RX00	160H	RY0F to RY00
	E1H	RX1F to RX10	161H	RY1F to RY10
2	E2H	RX2F to RX20	162H	RY2F to RY20
	E3H	RX3F to RX30	163H	RY3F to RY30
3	E4H	RX4F to RX40	164H	RY4F to RY40
	E5H	RX5F to RX50	165H	RY5F to RY50
4	E6H	RX6F to RX60	166H	RY6F to RY60
	E7H	RX7F to RX70	167H	RY7F to RY70
5	E8H	RX8F to RX80	168H	RY8F to RY80
	E9H	RX9F to RX90	169H	RY9F to RY90
6	EAH	RXAF to RXA0	16AH	RYAF to RYA0
	EBH	RXBF to RXB0	16BH	RYBF to RYB0
⋮	⋮	⋮	⋮	⋮

•I/O memory map of EX260-SMJ1/2  
(For station number 1)

Remote input (RX)		Remote output (RY)	
RX00	Unused	RY00	Output No.0
⋮		RY01	Output No.1
⋮		RY02	Output No.2
⋮	⋮	⋮	⋮
RX0F	⋮	RY0E	Output No.14
⋮	Unused	RY0F	Output No.15
RX10		RY10	Output No.16
⋮		RY11	Output No.17
⋮	⋮	RY12	Output No.18
⋮	⋮	⋮	⋮
⋮	⋮	RY1E	Output No.30
RX1F	⋮	RY1F	Output No.31

•I/O memory map of EX260-SMJ3/4  
(For station number 1)

Remote input (RX)		Remote output (RY)	
RX00	Unused	RY00	Output No.0
⋮		RY01	Output No.1
⋮		RY02	Output No.2
⋮	⋮	⋮	⋮
RX0F	⋮	RY0E	Output No.14
⋮	Unused	RY0F	Output No.15
RX10		RY10	Unused
⋮		⋮	Unused
⋮	⋮	⋮	Unused
⋮	⋮	⋮	Unused
RX1F	⋮	RY1F	Unused

Unused area cannot be used.  
When remote I/O station is assigned to master station buffer area, the area of 32 inputs/32 outputs will be used.

- 0: Solenoid valve OFF
- 1: Valve ON

○Output number assignment  
Output data

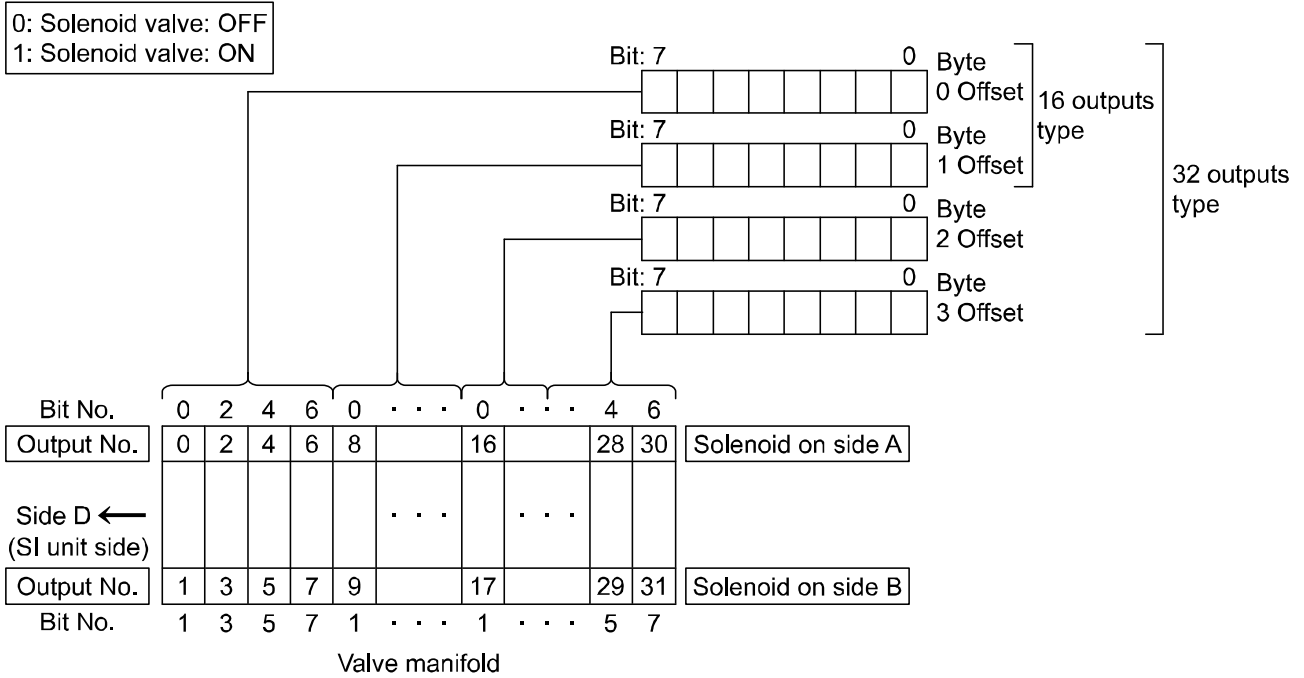

- \*: The output numbering refers to the solenoid position on the manifold and starts at zero.
- \*: Standard wiring of the manifold is for double-solenoid valves and the output number starts at the A side and then B side in that order as shown in the figure a.  
If a single-solenoid valve is mounted on the standard wiring manifold, the output number for the B side valve is skipped.
- \*: Custom wiring for mixed mounting single-solenoid valves and double-solenoid valves can be specified with a Wiring Specification Sheet. Example wiring is shown in the figure b.
- \*: Bit status "0" and "1" in the data corresponds to solenoid valve status OFF and ON (0: OFF, 1: ON), and the output number starts at zero from LSB (least significant bit).

fig.a

	No.	Station	No.
Double	4	3	5
Single	2	2	3 free
Double	0	1	1

fig.b

	No.	Station	No.
Double	3	3	4
Single	2	2	-
Double	0	1	1

# Troubleshooting and Maintenance

## ○Troubleshooting chart

When any malfunction is observed, it is recommended to perform the following troubleshooting.

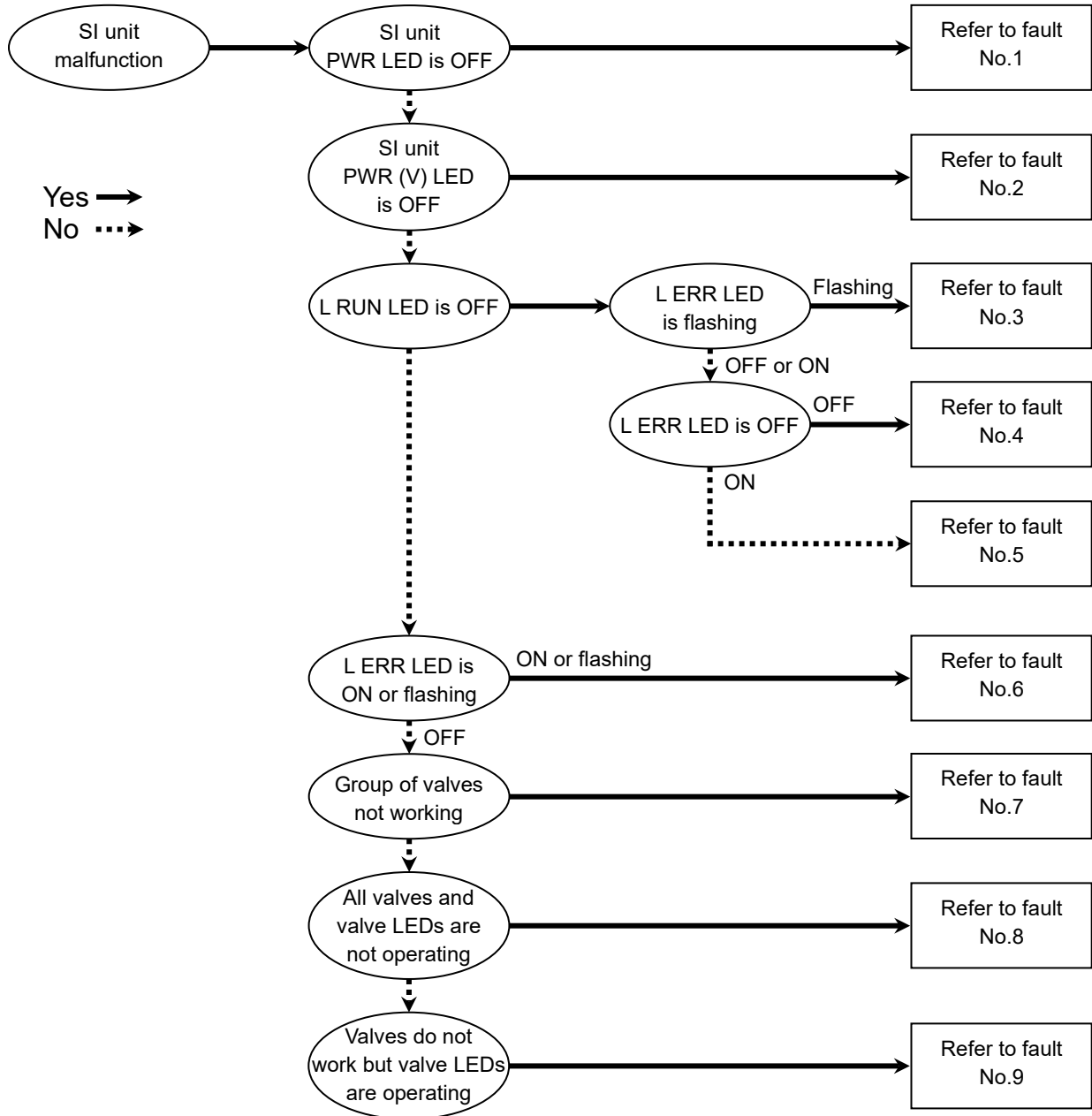

## Troubleshooting table

### Fault No.1

Fault	Probable cause	Recommended error handling	Recommended action
SI unit PWR LED is OFF	Defective power cable wiring for SI unit operation	Check the condition of the power cable wiring to the SI unit.	Re-tighten the power cable. (Replace the cable if it is broken)
			Correct the power cable wiring layout.
	SI unit operating voltage is not supplied	Check the condition of the supply voltage to the SI unit.	Supply 24 VDC $\pm$ 10% to the SI unit.

### Fault No.2

Fault	Probable cause	Recommended error handling	Recommended action
SI unit PWR (V) LED is OFF	Defective power cable wiring for the solenoid valve	Check the condition of the power cable wiring for the valve.	Re-tighten the power cable. (Replace the cable if it is broken)
			Correct the power cable wiring layout.
	Load voltage for the valve is not supplied	Check the condition of the supply voltage for the valve.	Supply 24 VDC +10%/-5% to the valves.

### Fault No.3

Fault	Probable cause	Recommended error handling	Recommended action
L RUN LED is OFF	L ERR LED is flashing	Incorrect network length or terminating resistor	Check the network length is acceptable for the communication speed, check that the terminating resistor is present at both ends, and check that a suitable CC-Link cable has been used.
		Incorrect setting change of the communication speed	Check that the communication speed setting has not been changed whilst power was supplied to the SI unit.
		Incorrect setting change of the station number.	Check that the station number setting was not changed whilst power was supplied to the SI unit.
		Communication failure	Check that there is no noise source or high voltage lines around the communication or power supply cables.
			Wire and set correctly.
			Turn off the power supply for the SI unit. After setting correctly supply power to the SI unit.
			Keep noise sources away from the communication and power supply cables.

Fault No.4

Fault		Probable cause	Recommended error handling	Recommended action
L RUN LED is OFF	L ERR LED is OFF	Failure of the power supply for the master station	Confirm that power is supplied to the master station	Supply power to the master station correctly.
		Communication line wiring failure	Check the communication cable is not broken, and that there are no loose connections between the power supply cable and connector. Confirm that repeated bending stress or pulling force which can cause a broken open wire is not applied to the cable.	Connect the communication cable correctly.
			Check for correct wiring of the communication cable.	Wire correctly.
		Communication failure	Check that there is no noise source or high voltage lines around the communication or power supply cables.	Keep noise sources away from the communication and power supply cables.
		Incorrect station number	Check that the station number setting and the station information set in the master is correct.	Set correctly.
Communication speed setting is incorrect.	Check that the communication speed setting of the SI unit and the communication speed setting of the master are the same.			

Fault No.5

Fault		Probable cause	Recommended error handling	Recommended action
L RUN LED is OFF	L ERR LED is ON	Incorrect or duplicated station number setting.	Check the station number setting of the SI unit and check for duplicated station number settings.	Set correctly.
		Incorrect communication speed setting.	Check that the SI unit communication speed setting is correct.	

Fault No.6

Fault		Probable cause	Recommended error handling	Recommended action
L RUN LED is ON	L ERR LED is flashing	Incorrect change of the communication speed	Check that the communication speed setting has not been changed whilst power is supplied to the SI unit.	Turn off the power supply for the SI unit. After setting correctly supply power to the SI unit.
		Incorrect change of the station number.	Check that the station number setting has not been changed whilst power is supplied to the SI unit.	
		Communication failure	Check that there is no noise source or high voltage lines around the communication or power supply cables.	Keep noise sources away from the communication and power supply cables.



#### Fault No.7

Fault	Probable cause	Recommended error handling	Recommended action
Group of valves not working	Too many valves	<p>Check if solenoid count does not exceed the allowable number. This depends on the SI unit model and valve series.</p> <p>Allowable solenoid number by valve series: SY/SV/S0700 series: 32 points VQC series: 24 points</p>	Keep the number of mounted solenoid valves within specification.

#### Fault No.8

Fault	Probable cause	Recommended error handling	Recommended action
All valves and valve LEDs are not operating	Poor connection between SI unit and valve manifold	Check if there are any loose screws making the connection between the SI unit and the valve manifold.	Tighten the screws with the specified tightening torque (i.e. 0.6 N•m) and make sure there is no gap between the SI unit and the valve manifold.
	Mismatch polarity between solenoid valve and SI unit output	Check if the solenoid valve common specification matches the output polarity of the SI unit.	Match polarity between solenoid valve and SI unit output.
	Defective solenoid valve	Follow the troubleshooting for the solenoid valve.	Same as left.

#### Fault No.9

Fault	Probable cause	Recommended error handling	Recommended action
Valves do not work but valve LEDs are operating	Mismatch polarity between solenoid valve and SI unit output	Check if the solenoid valve common specification matches the output polarity of the SI unit.	Match polarity between solenoid valve and SI unit output.

○Maintenance

Replacement of the SI unit

- Remove the M3 hexagon screws from the SI unit and release the SI unit from the valve manifold.
- Replace the SI unit.
- Tighten the screws with the specified tightening torque. (0.6 N•m)

Precautions for maintenance

- (1) Be sure to switch off the power.
- (2) Check there is no foreign matter inside the SI unit.
- (3) Check there is no damage and no foreign matter being stuck to the gasket.
- (4) Be sure to tighten the screws with the specified torque.

If the SI unit is not assembled properly, inside PCBs may be damaged or liquid and/or dust may enter into the unit.

○Assembly and disassembly of the SI unit

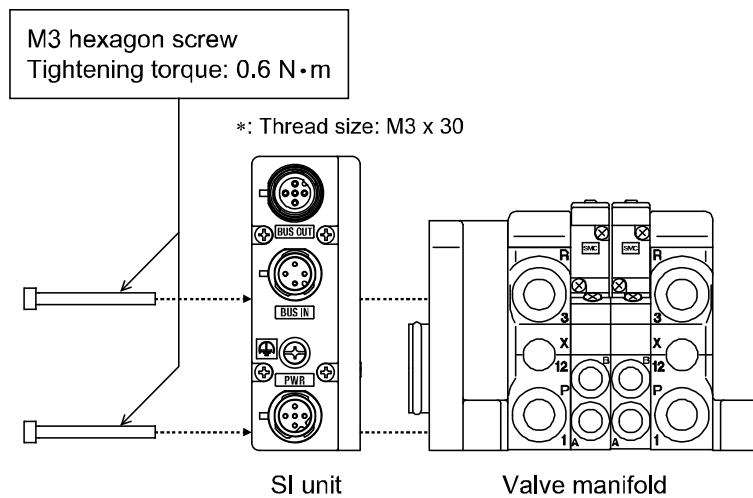

# Specifications

## ■ Specifications

### General specifications

Item	Specifications
Ambient temperature	-10 to +50 °C
Ambient humidity	35 to 85%RH (No condensate)
Ambient temperature for storage	-20 to +60 °C
Withstand voltage	500 VAC applied for 1 minute
Insulation resistance	500 VDC, 10 MΩ or more
Operating atmosphere	No corrosive gas
Enclosure	IP67
Weight	200 g or less
Standard	UL/CSA, CE marked (EMC directive, RoHS directive)

### Electrical specifications

Item		Specifications	
Current consumption in power supply voltage range	Current consumption of controller power supply	21.6 to 26.4 VDC 0.1 A max.	
	Solenoid valve power supply	22.8 to 26.4 VDC 2.0 A or less, according to the solenoid valve station specification	
Solenoid valve connecting specification	Output type	EX260-SMJ1/-SMJ3	PNP (negative common) / source
		EX260-SMJ2/-SMJ4	NPN (positive common) / Sink
	Number of outputs	EX260-SMJ1/-SMJ2	32 outputs
		EX260-SMJ3/-SMJ4	16 outputs
	Output condition at the time of communication error	Output HOLD/CLEAR	
	Connected load	Solenoid valve with surge voltage suppressor of 24 VDC and 1.5 W or less (manufactured by SMC)	
	Insulation type	Photo coupler insulation type	
Residual voltage	0.4 VDC or less		

### Network communication specifications

Item	Specifications
Applicable system	CC-Link Ver.1.10 *
Occupied number of stations	1 station
Allowable station number setting	1 to 64
Station type	Remote I/O
Transmission speed	156 kbps / 625 kbps / 2.5 Mbps / 5 Mbps / 10 Mbps

\*: It is possible to connect the "Ver.1.10" SI unit (slave) to the "Ver.2.00" compliant master unit (master).

### Connectable valve series

Valve Series	
SY series	SY3000, SY5000, SY7000
VQC series	VQC1000, VQC2000, VQC4000, VQC5000
SV series	SV1000, SV2000, SV3000 (10 type tie-rod base)
S0700 series	S0700

\*: The valve manifolds that can be connected are the same as those connectable to EX250 series.

## ■Dimensions

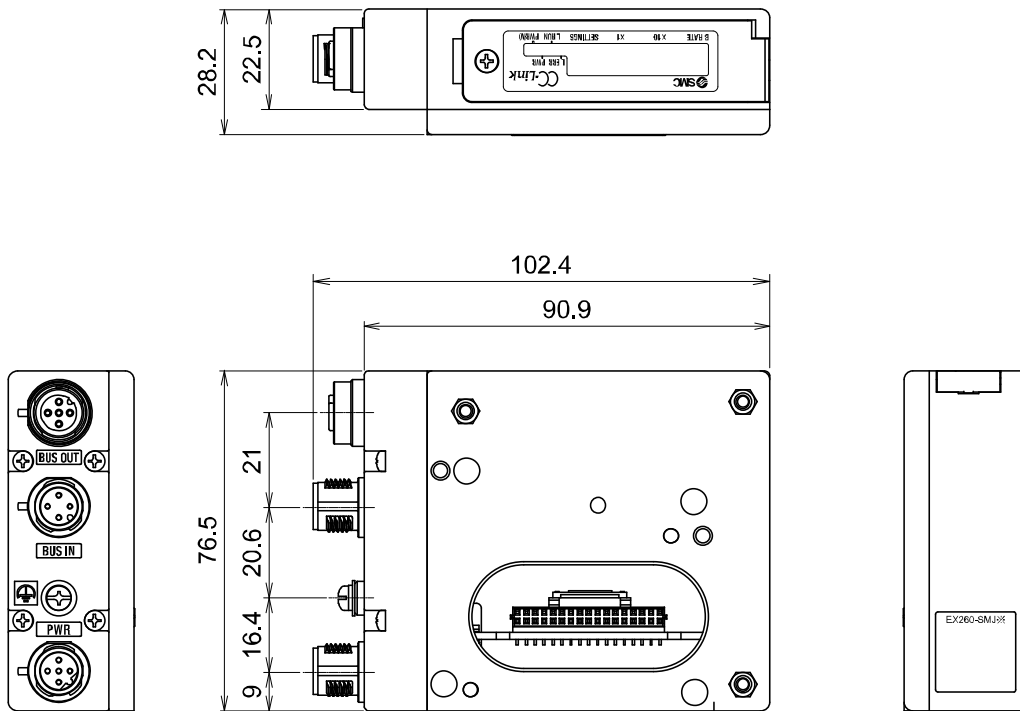

- If a fieldwireable connector is used for the power supply connection, and the SI unit is installed directly to a valve manifold, the cable connector's outer diameter should be  $\phi 16$  mm or less. If it is a larger diameter, the connector will interfere with the mounting surface. Recommended cables are specified on page 28.

## Accessories

### Fieldbus interface connector (BUS OUT)

#### (1) Cable with communication connector (SPEEDCON)

Part number: PCA-1567717

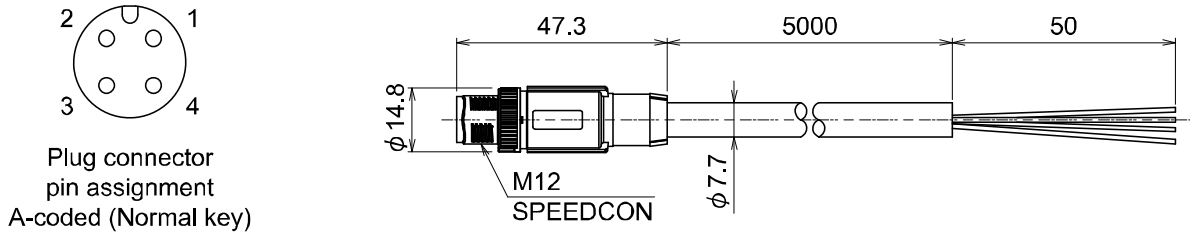

Item	Specifications
Cable O.D.	$\phi 7.7$ mm
Nominal cross section	AWG20
Wire diameter (Including insulator)	2.55 mm
Min. bending radius (Fixed)	77 mm

Pin No.	Cable colour: Signal
1	: SLD
2	White : DB
3	Yellow: DG
4	Blue : DA

#### (2) Fieldwireable connector (SPEEDCON)

Part number: PCA-1075526

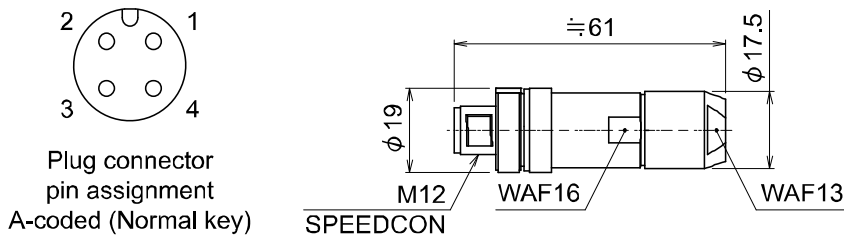

#### Applicable cable

Item	Specifications
Cable O.D.	$\phi 4.0$ to 8.0 mm
Wire gauge	0.14 to 0.75 mm <sup>2</sup> /AWG26 to 18 (Solid/Stranded) 0.08 to 0.5 mm <sup>2</sup> /AWG28 to 20 (with ferrules)

\*: This table shows the specifications of the applicable cable.

Adaptation for the connector may vary on account of the conductor construction of the electric wire.

- Fieldbus interface connector (BUS IN)
  - (1) Cable with communication connector (SPEEDCON)

Part number: PCA-1567720

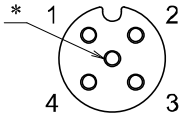

Socket connector  
pin assignment  
A-coded (Normal key)  
\*: Number of holes: 5,  
Total number of pins: 4

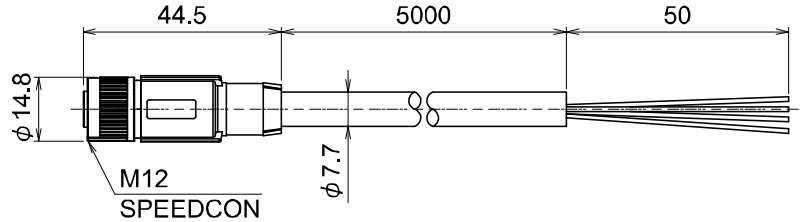

Item	Specifications
Cable O.D.	φ7.7 mm
Nominal cross section	AWG20
Wire diameter (Including insulator)	2.55 mm
Min. bending radius (Fixed)	77 mm

Pin No.	Cable colour: Signal
1	: SLD
2	White : DB
3	Yellow: DG
4	Blue : DA

- (2) Fieldwireable connector (SPEEDCON)

Part number: PCA-1075527

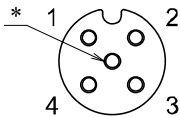

Socket connector  
pin assignment  
A-coded (Normal key)  
\*: Number of holes: 5,  
Total number of pins: 4

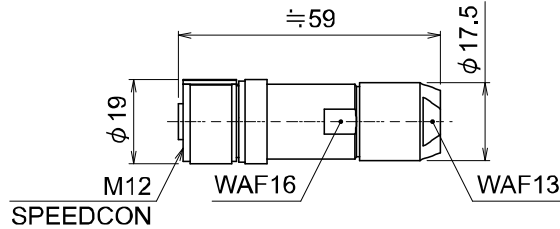

Applicable cable

Item	Specifications
Cable O.D.	φ4.0 to 8.0 mm
Wire gauge	0.14 to 0.75 mm <sup>2</sup> /AWG26 to 18 (Solid/Stranded) 0.08 to 0.5 mm <sup>2</sup> /AWG28 to 20 (with ferrules)

\*: This table shows the specifications of the applicable cable.  
Adaptation for the connector may vary on account of the conductor construction of the electric wire.

○Cable with both sides connector (SPEEDCON)

Part number: EX9-AC 005 MJ- SSPS (Socket/Plug)

Cable length (L)	
005	500 mm
010	1000 mm
020	2000 mm
030	3000 mm
050	5000 mm
100	10000 mm

Connector specification	
SSPS	Socket side: Straight, Plug side: Straight
SAPA	Socket side: Angled, Plug side: Angled

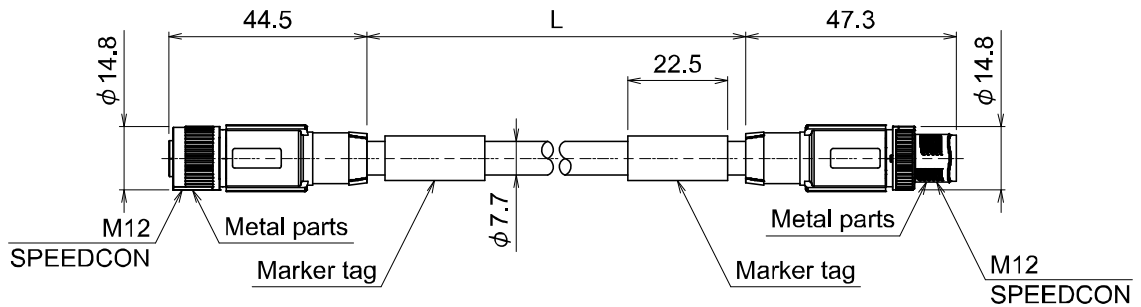

Straight connector type (EX9-AC#MJ-SSPS)

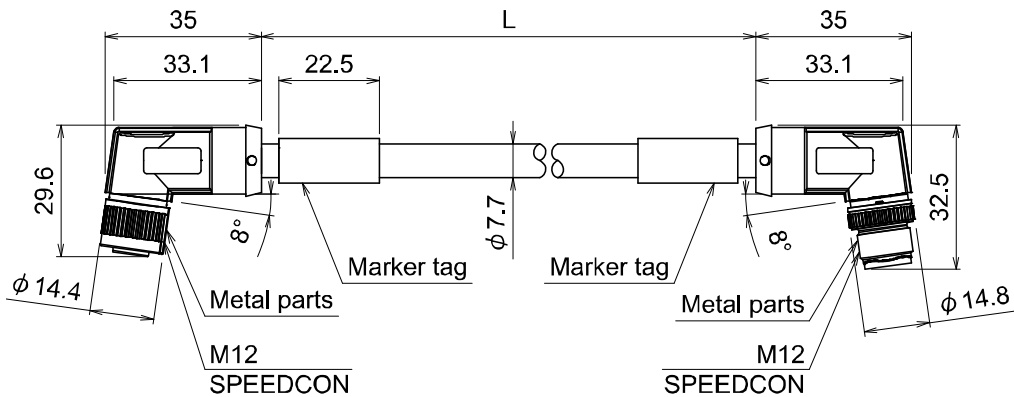

Angled connector type (EX9-AC#MJ-SAPA)

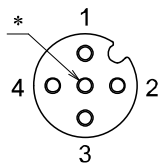

Socket connector  
pin assignment  
A-coded (Normal key)  
\*: Number of holes: 5,  
Total number of pins: 4

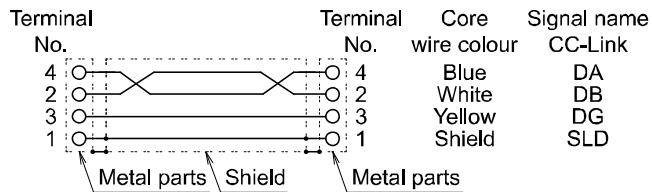

Connections

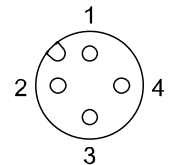

Plug connector  
pin assignment  
A-coded (Normal key)

Item		Specifications
Cable O.D.		φ7.7 mm
Conductor nominal cross section	Data pair	0.5 mm <sup>2</sup> /AWG20
	Drain	0.34 mm <sup>2</sup> /AWG22
Wire diameter (Including insulator)		2.55 mm
Min. bending radius (Fixed)		77 mm

○Power supply connector

(1) Cable with power supply connector

Part number: EX9-AC0 **1** 0-1

● Cable length (L)

1	1000 [mm]
3	3000 [mm]
5	5000 [mm]

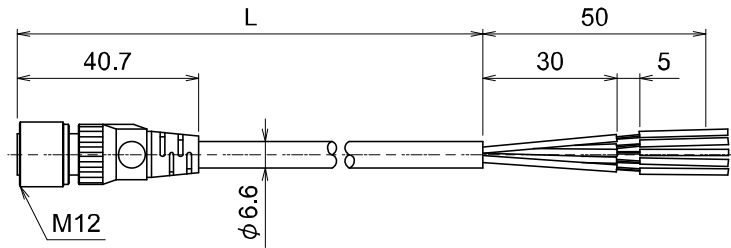
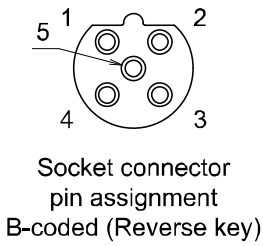

Item	Specifications
Cable O.D.	φ6.6 mm
Nominal cross section	AWG22
Wire diameter (Including insulator)	1.65 mm
Min. bending radius (Fixed)	40 mm

Pin No.	Cable colour: Signal
1	Brown: 24 VDC (For solenoid valve)
2	White : 0 V (For solenoid valve)
3	Blue : 24 VDC (For control)
4	Black : 0 V (For control)
5	Gray : Not connected

(2) Cable with power supply connector (SPEEDCON)

Part number: PCA-140180 **7**

● Cable length (L)

7	1500 [mm]
8	3000 [mm]
9	5000 [mm]

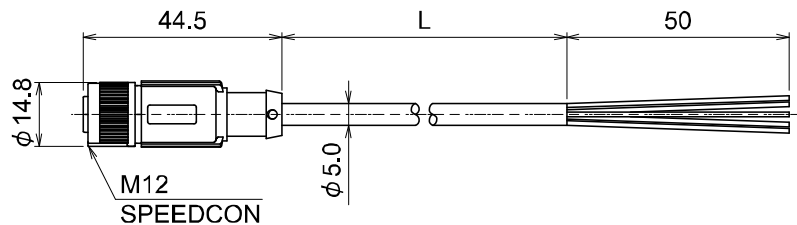
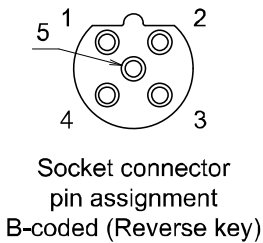

Item	Specifications
Cable O.D.	φ5.0 mm
Nominal cross section	AWG22
Wire diameter (Including insulator)	1.27 mm
Min. bending radius (Fixed)	21.7 mm

Pin No.	Cable colour: Signal
1	Brown : 24 VDC (For solenoid valve)
2	White : 0 V (For solenoid valve)
3	Blue : 24 VDC (For control)
4	Black : 0 V (For control)
5	Green/Yellow: Not connected



○Seal cap

For M12 connector socket: 10 pcs.

**Part number: EX9-AWTS**

This cap is used to protect the M12 connector opening when the connector is not used.  
When the "BUS OUT" connector is not used, the seal cap can keep the SI unit under IP67 rated protection.

(One seal cap will be attached to the SI unit when shipped from factory.)

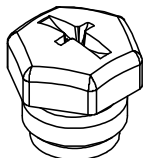

#### Revision history

A: Addition of accessories.  
B: Modified errors in text.  
C: Limited warranty and Disclaimer are added.  
D: Modified errors in text.  
E: Contents are added.  
F: Contents are added. [July 2016]  
G: Contents revised in several places. [August 2019]  
H: Modified errors in text. [ November 2019]  
I: Contents revised in several places. [June 2022]

## SMC Corporation

4-14-1, Sotokanda, Chiyoda-ku, Tokyo 101-0021 JAPAN

Tel: + 81 3 5207 8249 Fax: +81 3 5298 5362

URL <https://www.smcworld.com>

---

Note: Specifications are subject to change without prior notice and any obligation on the part of the manufacturer.  
© 2011-2022 SMC Corporation All Rights Reserved

