



Operation Manual

PRODUCT NAME

SI unit for Ethernet POWERLINK

MODEL / Series / Product Number

EX260 Series

SMC Corporation

Table of Contents

Safety Instructions	2
Model Indication and How to Order	8
Summary of Product elements	9
Installation and Wiring	10
Installation	10
Wiring	11
LED Indication and Settings	15
Configuration	17
Troubleshooting and Maintenance	21
Specifications	26
Specifications	26
Dimensions	28
Accessories	29



Safety Instructions

These safety instructions are intended to prevent hazardous situations and/or equipment damage. These instructions indicate the level of potential hazard with the labels of "Caution", "Warning" or "Danger". They are all important notes for safety and must be followed in addition to International Standards (ISO/IEC)*1), and other safety regulations.

*1) ISO 4414: Pneumatic fluid power -- General rules relating to systems.

ISO 4413: Hydraulic fluid power -- General rules relating to systems.

IEC 60204-1: Safety of machinery -- Electrical equipment of machines .(Part 1: General requirements)

ISO 10218: Manipulating industrial robots -Safety.

etc.



Caution

Caution indicates a hazard with a low level of risk which, if not avoided, could result in minor or moderate injury.



Warning

Warning indicates a hazard with a medium level of risk which, if not avoided, could result in death or serious injury.



Danger

Danger indicates a hazard with a high level of risk which, if not avoided, will result in death or serious injury.

Warning

1. The compatibility of the product is the responsibility of the person who designs the equipment or decides its specifications.

Since the product specified here is used under various operating conditions, its compatibility with specific equipment must be decided by the person who designs the equipment or decides its specifications based on necessary analysis and test results.

The expected performance and safety assurance of the equipment will be the responsibility of the person who has determined its compatibility with the product.

This person should also continuously review all specifications of the product referring to its latest catalog information, with a view to giving due consideration to any possibility of equipment failure when configuring the equipment.

2. Only personnel with appropriate training should operate machinery and equipment.

The product specified here may become unsafe if handled incorrectly.

The assembly, operation and maintenance of machines or equipment including our products must be performed by an operator who is appropriately trained and experienced.

3. Do not service or attempt to remove product and machinery/equipment until safety is confirmed.

1. The inspection and maintenance of machinery/equipment should only be performed after measures to prevent falling or runaway of the driven objects have been confirmed.

2. When the product is to be removed, confirm that the safety measures as mentioned above are implemented and the power from any appropriate source is cut, and read and understand the specific product precautions of all relevant products carefully.

3. Before machinery/equipment is restarted, take measures to prevent unexpected operation and malfunction.

4. Contact SMC beforehand and take special consideration of safety measures if the product is to be used in any of the following conditions.

1. Conditions and environments outside of the given specifications, or use outdoors or in a place exposed to direct sunlight.

2. Installation on equipment in conjunction with atomic energy, railways, air navigation, space, shipping, vehicles, military, medical treatment, combustion and recreation, or equipment in contact with food and beverages, emergency stop circuits, clutch and brake circuits in press applications, safety equipment or other applications unsuitable for the standard specifications described in the product catalog.

3. An application which could have negative effects on people, property, or animals requiring special safety analysis.

4. Use in an interlock circuit, which requires the provision of double interlock for possible failure by using a mechanical protective function, and periodical checks to confirm proper operation.



Safety Instructions

Caution

1. The product is provided for use in manufacturing industries.

The product herein described is basically provided for peaceful use in manufacturing industries. If considering using the product in other industries, consult SMC beforehand and exchange specifications or a contract if necessary.
If anything is unclear, contact your nearest sales branch.

Limited warranty and Disclaimer/Compliance Requirements

The product used is subject to the following "Limited warranty and Disclaimer" and "Compliance Requirements".

Read and accept them before using the product.

Limited warranty and Disclaimer

1. The warranty period of the product is 1 year in service or 1.5 years after the product is delivered, whichever is first.*2)

Also, the product may have specified durability, running distance or replacement parts. Please consult your nearest sales branch.

2. For any failure or damage reported within the warranty period which is clearly our responsibility, a replacement product or necessary parts will be provided.

This limited warranty applies only to our product independently, and not to any other damage incurred due to the failure of the product.

3. Prior to using SMC products, please read and understand the warranty terms and disclaimers noted in the specified catalog for the particular products.

***2) Vacuum pads are excluded from this 1 year warranty.**

A vacuum pad is a consumable part, so it is warranted for a year after it is delivered.

Also, even within the warranty period, the wear of a product due to the use of the vacuum pad or failure due to the deterioration of rubber material are not covered by the limited warranty.

Compliance Requirements

1. The use of SMC products with production equipment for the manufacture of weapons of mass destruction (WMD) or any other weapon is strictly prohibited.

2. The exports of SMC products or technology from one country to another are governed by the relevant security laws and regulation of the countries involved in the transaction. Prior to the shipment of a SMC product to another country, assure that all local rules governing that export are known and followed.

Operator

- ◆ This operation manual is intended for those who have knowledge of machinery using pneumatic equipment, and have sufficient knowledge of assembly, operation and maintenance of such equipment. Only those persons are allowed to perform assembly, operation and maintenance.
- ◆ Read and understand this operation manual carefully before assembling, operating or providing maintenance to the product.

■ Safety Instructions

Warning

- Do not disassemble, modify (including changing the printed circuit board) or repair.
An injury or failure can result.
- Do not operate the product outside of the specifications.
Do not use for flammable or harmful fluids.
Fire, malfunction, or damage to the product can result.
Verify the specifications before use.
- Do not operate in an atmosphere containing flammable or explosive gases.
Fire or an explosion can result.
This product is not designed to be explosion proof.
- If using the product in an interlocking circuit:
 - Provide a double interlocking system, for example a mechanical system.
 - Check the product regularly for proper operation.Otherwise malfunction can result, causing an accident.
- The following instructions must be followed during maintenance:
 - Turn off the power supply.
 - Stop the air supply, exhaust the residual pressure and verify that the air is released before performing maintenance.Otherwise an injury can result.

Caution

- After maintenance is complete, perform appropriate functional inspections.
Stop operation if the equipment does not function properly.
Safety cannot be assured in the case of unexpected malfunction.
- Provide grounding to assure the noise resistance of the Serial System.
Individual grounding should be provided close to the product with a short cable.

■ NOTE

- Follow the instructions given below when designing, selecting and handling the product.
- The instructions on design and selection (installation, wiring, environment, adjustment, operation, maintenance, etc.) described below must also be followed.
 - *Product specifications
 - When conformity to UL is required, the SI unit should be used with a UL1310 Class 2 power supply.
 - The SI unit is a UL approved product only if they have a  mark on the body.
 - Use the specified voltage.
Otherwise failure or malfunction can result.
 - Reserve a space for maintenance.
Allow sufficient space for maintenance when designing the system.
 - Do not remove any nameplates or labels.
This can lead to incorrect maintenance, or misreading of the operation manual, which could cause damage or malfunction to the product.
It may also result in non-conformity to safety standards.

●Product handling

*Installation

- Do not drop, hit or apply excessive shock to the fieldbus system.
Otherwise damage to the product can result, causing malfunction.
- Tighten to the specified tightening torque.
If the tightening torque is exceeded the mounting screws may be broken.
IP67 protection cannot be guaranteed if the screws are not tightened to the specified torque.
- Never mount a product in a location that will be used as a foothold.
The product may be damaged if excessive force is applied by stepping or climbing onto it.

*Wiring

- Avoid repeatedly bending or stretching the cables, or placing heavy load on them.
Repetitive bending stress or tensile stress can cause breakage of the cable.
- Wire correctly.
Incorrect wiring can break the product.
- Do not perform wiring while the power is on.
Otherwise damage to the fieldbus system and/or I/O device can result, causing malfunction.
- Do not route wires and cables together with power or high voltage cables.
Otherwise the fieldbus system and/or I/O device can malfunction due to interference of noise and surge voltage from power and high voltage cables to the signal line.
Route the wires (piping) of the fieldbus system and/or I/O device separately from power or high voltage cables.
- Confirm proper insulation of wiring.
Poor insulation (interference from another circuit, poor insulation between terminals, etc.) can lead to excess voltage or current being applied to the product, causing damage.
- Take appropriate measures against noise, such as using a noise filter, when the fieldbus system is incorporated into equipment.
Otherwise noise can cause malfunction.
- Separate the power line for output devices from the power line for control.
Otherwise noise or induced surge voltage can cause malfunction.

*Environment

- Select the proper type of protection according to the environment of operation.
IP67 protection is achieved when the following conditions are met.
 - (1) The units are connected properly with fieldbus cable with M12 connector and power cable with M12 (M8) connector.
 - (2) Suitable mounting of each unit and manifold valve.

If using in an environment that is exposed to water splashes, please take measures such as using a cover.
- Do not use in a place where the product could be splashed by oil or chemicals.
If the product is to be used in an environment containing oils or chemicals such as coolant or cleaning solvent, even for a short time, it may be adversely affected (damage, malfunction etc.).
- Do not use the product in an environment where corrosive gases or fluids could be splashed.
Otherwise damage to the product and malfunction can result.
- Do not use in an area where surges are generated.
If there is equipment which generates a large amount of surge (solenoid type lifter, high frequency induction furnace, motor, etc.) close to the fieldbus system, this may cause deterioration or breakage of the internal circuit of the fieldbus system. Avoid sources of surge generation and crossed lines.
- When a surge-generating load such as a relay or solenoid is driven directly, use an fieldbus system with a built-in surge absorbing element.
Direct drive of a load generating surge voltage can damage the fieldbus system.
- The product is CE marked, but not immune to lightning strikes. Take measures against lightning strikes in the system.
- Prevent foreign matter such as remnant of wires from entering the fieldbus system to avoid failure and malfunction.

- Mount the product in a place that is not exposed to excessive vibration or impact.
Otherwise failure or malfunction can result.
- Do not use the product in an environment that is exposed to temperature cycle.
Heat cycles other than ordinary changes in temperature can adversely affect the inside of the product.
- Do not expose the product to direct sunlight.
If using in a location directly exposed to sunlight, shade the product from the sunlight.
Otherwise failure or malfunction can result.
- Keep within the specified ambient temperature range.
Otherwise malfunction can result.
- Do not operate close to a heat source, or in a location exposed to radiant heat.
Otherwise malfunction can result.

*Adjustment and Operation

- Perform settings suitable for the operating conditions.
Incorrect setting can cause operation failure.
- Please refer to the PLC manufacturer's manual etc. for details of programming and addresses.
For the PLC protocol and programming refer to the relevant manufacturer's documentation.
- The surface on the product may be hot.

*Maintenance

- Turn off the power supply, stop the supplied air, exhaust the residual pressure and verify the release of air before performing maintenance.
There is a risk of unexpected malfunction.
- Perform regular maintenance and inspections.
There is a risk of unexpected malfunction.
- After maintenance is complete, perform appropriate functional inspections.
Stop operation if the equipment does not function properly.
Otherwise safety is not assured due to an unexpected malfunction or incorrect operation.
- Do not use solvents such as benzene, thinner etc. to clean the each unit.
They could damage the surface of the body and erase the markings on the body.
Use a soft cloth to remove stains.
For heavy stains, use a cloth soaked with diluted neutral detergent and fully squeezed, then wipe up the stains again with a dry cloth.

Model Indication and How to Order

EX260-SPL 1

- Connector type, output specification

1	M12 connector, 32 outputs, PNP (negative common) / source
3	M12 connector, 16 outputs, PNP (negative common) / source

- Fieldbus

PL	POWERLINK
----	-----------

Summary of Product elements

<EX260-SPL1/-SPL3>

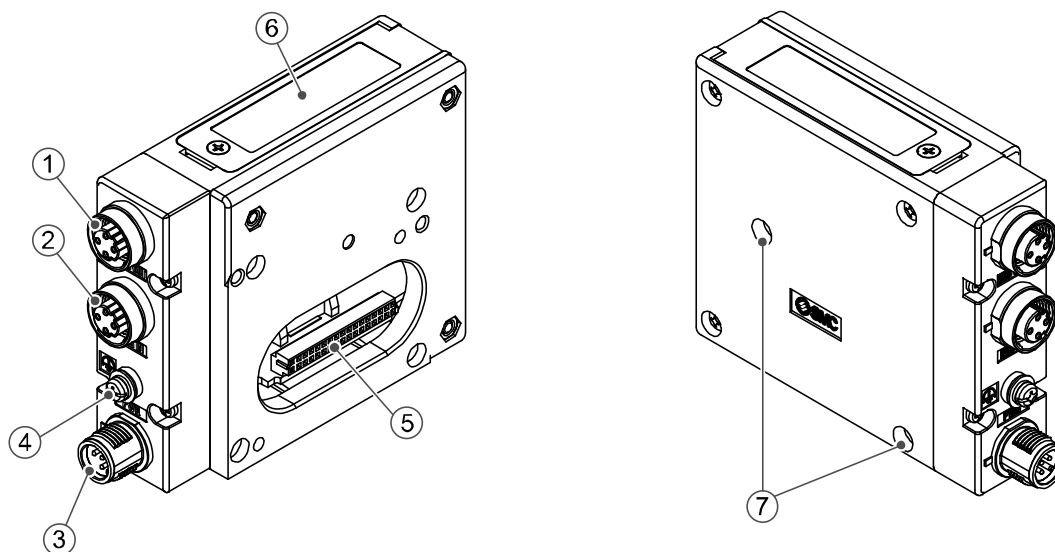

No.	Element	Description
1	Fieldbus interface connector (BUS OUT/Port2)	POWERLINK connection PORT 2. *1 (M12 4-pin socket, D-coded)
2	Fieldbus interface connector (BUS IN/Port1)	POWERLINK connection PORT 1. *1 (M12 4-pin socket, D-coded)
3	Power supply connector	Power supply with load voltage for valves and operating voltage for SI unit. *1 (M12 5-pin plug, A-coded)
4	FE terminal	Functional earth. (M3 screw)
5	Output connector	Output signal interface for valve manifold.
6	LED display	LED display to indicate the status of the SI unit. *2
7	Mounting hole	Mounting hole for connection to the valve manifold.

Accessories

Hexagon socket head cap screw	2 pcs. M3 x 30 screw for connection to the valve manifold.
Seal cap	1 pc. seal cap for unused fieldbus interface connector (BUS OUT).

*1: For details of suitable cables refer to the Accessories section on page 29.

*2: Refer to page 15 for the LED Indication and Settings.

Installation and Wiring

■ Installation

Connect valve manifold to the SI unit.

• Dimensions for installation

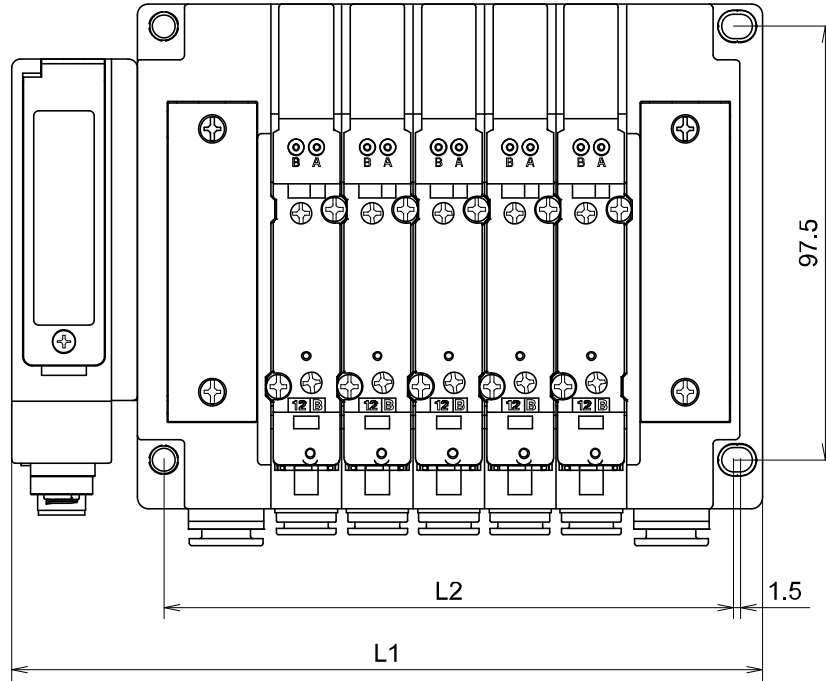

n: number of valve stations

L \ n	1	2	3	4	5	6	7	8	
L1		120.7	136.7	152.7	168.7	184.7	200.7	216.7	
L2		80	96	112	128	144	160	176	
L \ n	9	10	11	12	13	14	15	16	
L1		232.7	248.7	264.7	280.7	296.7	312.7	328.7	344.7
L2		192	208	224	240	256	272	288	304

(mm)

The above table shows dimensions as an example for the SY5000 series valve manifold.
Refer to the EX260 series valve manifold section in the valve catalogue for valve manifold dimensions.

■Wiring

Select the appropriate cables to mate with the connectors mounted on the SI unit.
Refer to Accessories (page 29).

○Fieldbus interface connector layout

BUS OUT/Port2: M12 4-pin socket, D-coded (SPEEDCON)

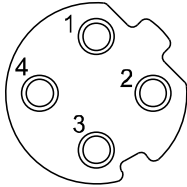

No.	Designation	Description
1	TD+	Transmit Data +
2	RD+	Receive Data +
3	TD-	Transmit Data -
4	RD-	Receive Data -

BUS IN/Port1: M12 4-pin socket, D-coded (SPEEDCON)

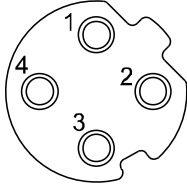

No.	Designation	Description
1	TD+	Transmit Data +
2	RD+	Receive Data +
3	TD-	Transmit Data -
4	RD-	Receive Data -

The M12 connector cable has two types, SPEEDCON compatible and non-compatible. If both plug and socket sides have connectors for SPEEDCON, the cable can be inserted and connected by turning it a 1/2 of a rotation, leading to reduction in work hour.
A non-compatible connector can be connected to a compatible connector as well as an M12.

Connect the "BUS IN" connector to the upstream device (PLC etc.) and connect the "BUS OUT" connector to the downstream device.

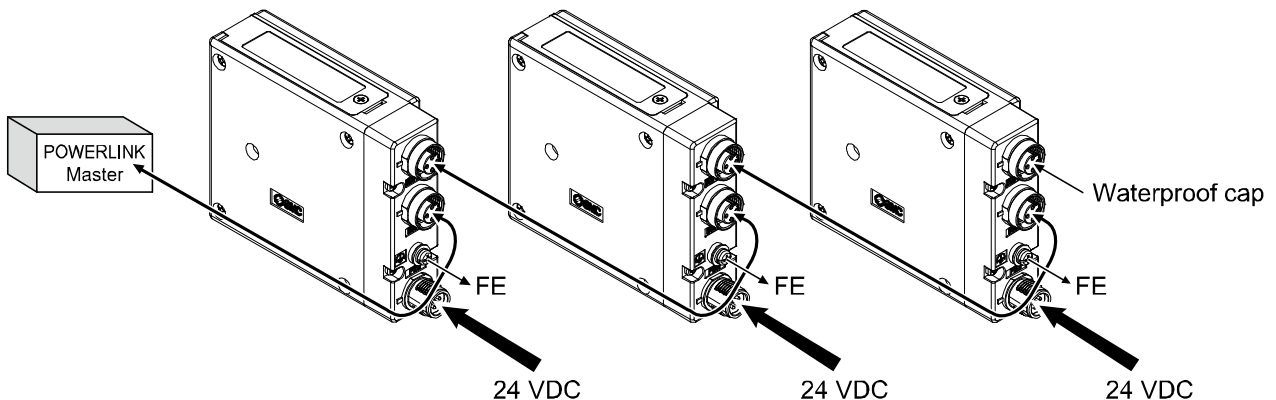

Note

- Be sure to fit a seal cap on any unused connectors.
Proper use of the seal cap enables the enclosure to achieve IP67 specification.

*: Refer to page 30 for the seal cap.

○Power supply connector layout

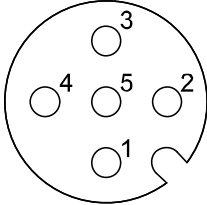

PWR: M12 5-pin plug, A-coded (SPEEDCON)

No.	Designation	Description
1	SV24 V	+24 V for solenoid valve
2	SV0 V	0 V for solenoid valve
3	SI24 V	+24 V for SI unit operation
4	SI0 V	0 V for SI unit operation
5	-	Unused

The M12 connector cable has two types, SPEEDCON compatible and non-compatible. If both plug and socket sides have connectors for SPEEDCON, the cable can be inserted and connected by turning it a 1/2 of a rotation, leading to reduction in work hour.
A non-compatible connector can be connected to a compatible connector as well as an M12.

Power-supply line for solenoid valve and power-supply line for SI unit operation are isolated.
Be sure to supply power, respectively.
Either single-source power or two different power supplies can be used.

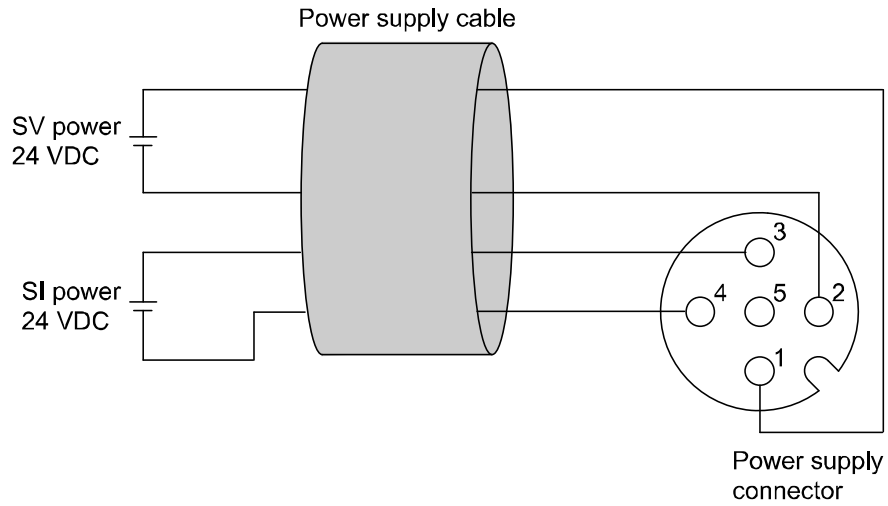

A. Two different power supply

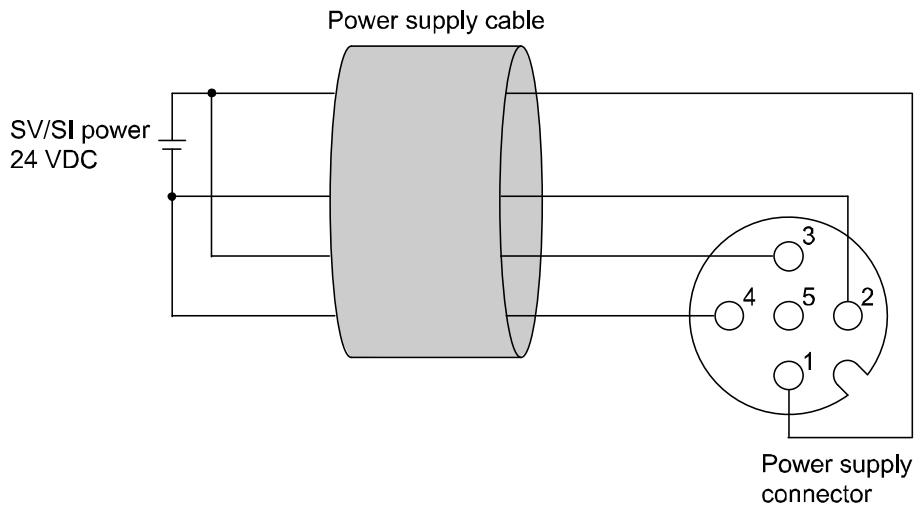

B. Single-source power supply

*: Pay attention not to exceed the tolerance range of power supply voltage.

○FE terminal

Connect the FE terminal to ground.

Resistance to ground should be 100 ohms or less.

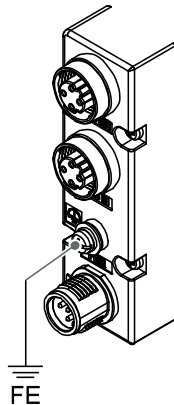

LED Indication and Settings

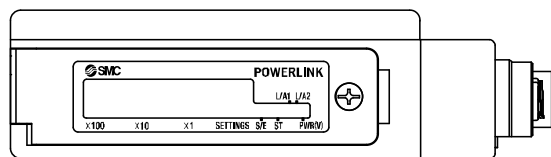

LED indication

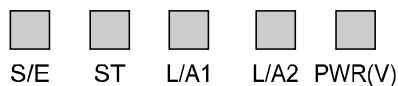

LED	Status	Description
S/E	<input type="checkbox"/> OFF	SI unit operating voltage is not supplied.
	<input checked="" type="checkbox"/> Green flashing	POWERLINK communication has not been established. Fast flashing (note 1): Basic Ethernet state Single flash (note 2): Pre-Operational 1 Double flash (note 3): Pre-Operational 2 Triple flash (note 4): Ready to operate Slow flashing (note 5): Stopped
	<input checked="" type="checkbox"/> Green ON	POWERLINK communication has been established.
	<input checked="" type="checkbox"/> Red ON	POWERLINK communication has been separated or Node ID set outside range.
ST	<input type="checkbox"/> OFF	SI unit operating voltage is not supplied.
	<input checked="" type="checkbox"/> Green ON	Operating normally.
	<input checked="" type="checkbox"/> Red ON	SI unit has failed.
L/A1	<input type="checkbox"/> OFF	BUS IN side: No Link, No Activity
	<input checked="" type="checkbox"/> Green ON	BUS IN side: Link, No Activity
	<input checked="" type="checkbox"/> Green flashing	BUS IN side: Link, Activity
L/A2	<input type="checkbox"/> OFF	BUS OUT side: No Link, No Activity
	<input checked="" type="checkbox"/> Green ON	BUS OUT side: Link, No Activity
	<input checked="" type="checkbox"/> Green flashing	BUS OUT side: Link, Activity
PWR(V)	<input checked="" type="checkbox"/> Green ON	Load voltage for the valve is supplied.
	<input type="checkbox"/> OFF	Load voltage for the valve is not supplied or is outside tolerance range (19 V or less).

Note 1: ON/OFF 50 ms flashing

Note 2: ON 200 ms single flash, OFF 1 s

Note 3: ON/OFF 200 ms double flash, OFF 1 s

Note 4: ON/OFF 200 ms triple flash, OFF 1 s

Note 5: ON/OFF 200 ms flashing

○Switch setting

The switches should only be set with the power supply turned off.

Open the cover and set the rotary switches and DIP switch with a small flat blade screwdriver.

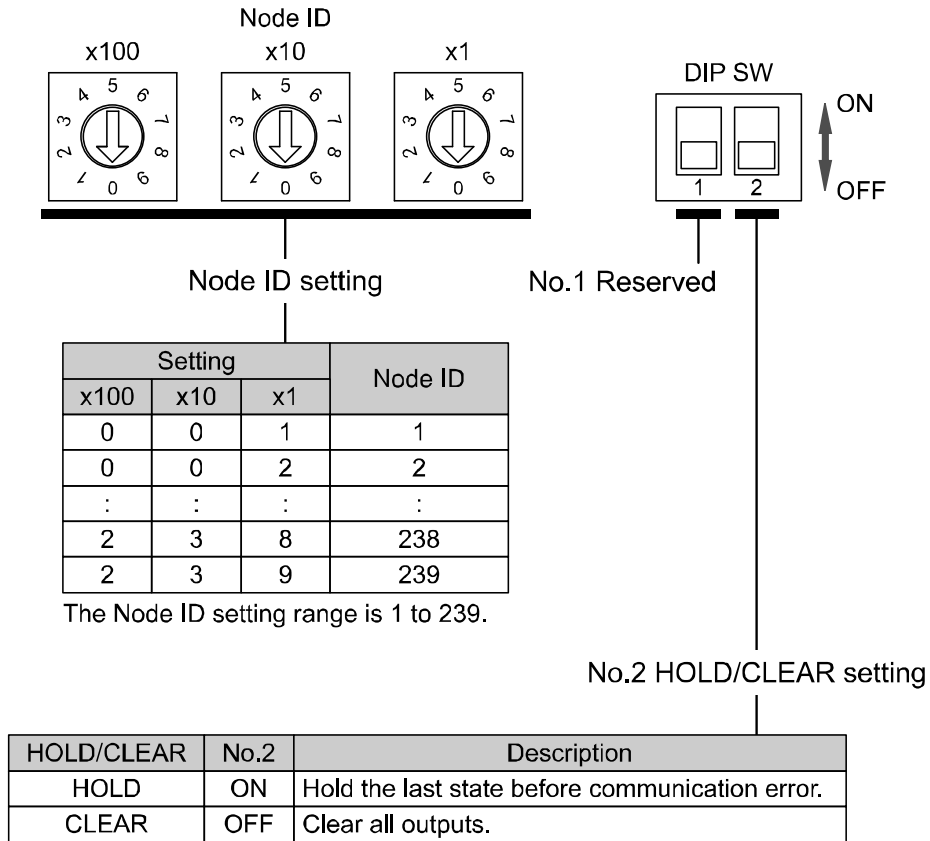

■ Configuration

An applicable XDD file is required to configure the SI unit in the POWERLINK network.
Please download the latest XDD file from the SMC website (URL <http://www.smcworld.com>).

XDD file

	Model number	XDD file
1	EX260-SPL1	FFFF0007_EX260-SPL1.xdd
2	EX260-SPL3	FFFF0007_EX260-SPL3.xdd

The network configuration procedure using the B&R's Automation Studio is described below.

1) Select "Import Fieldbus Device..." from "Tools" in the Main menu, and install XDD file.

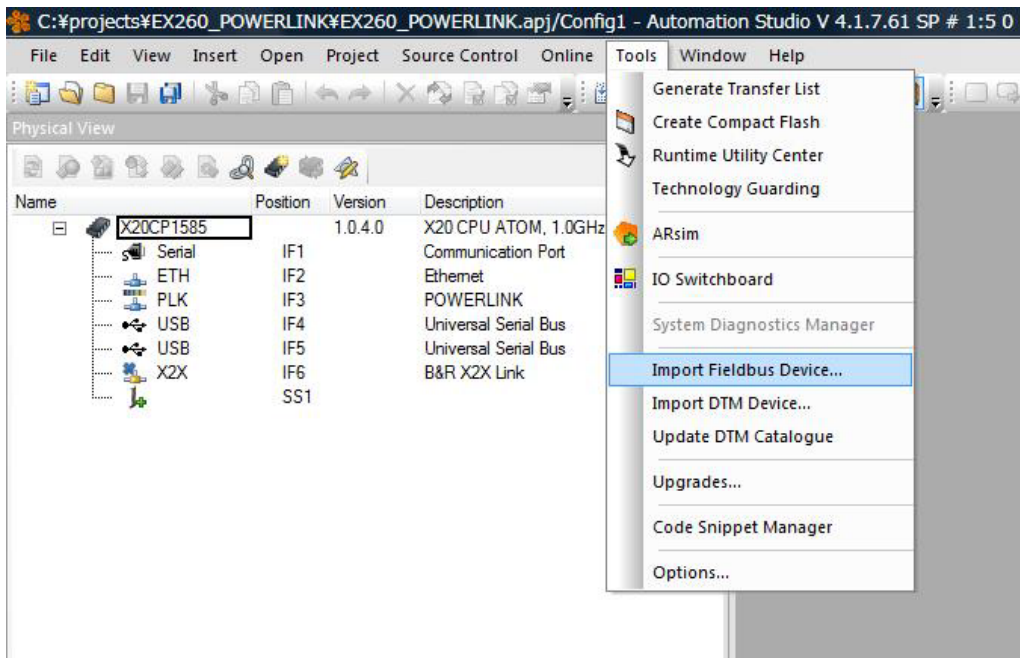

Automation Studio software is manufactured by B&R.

2) Select "Add Hardware Module..." by right clicking "PLK" from the Project Explorer.

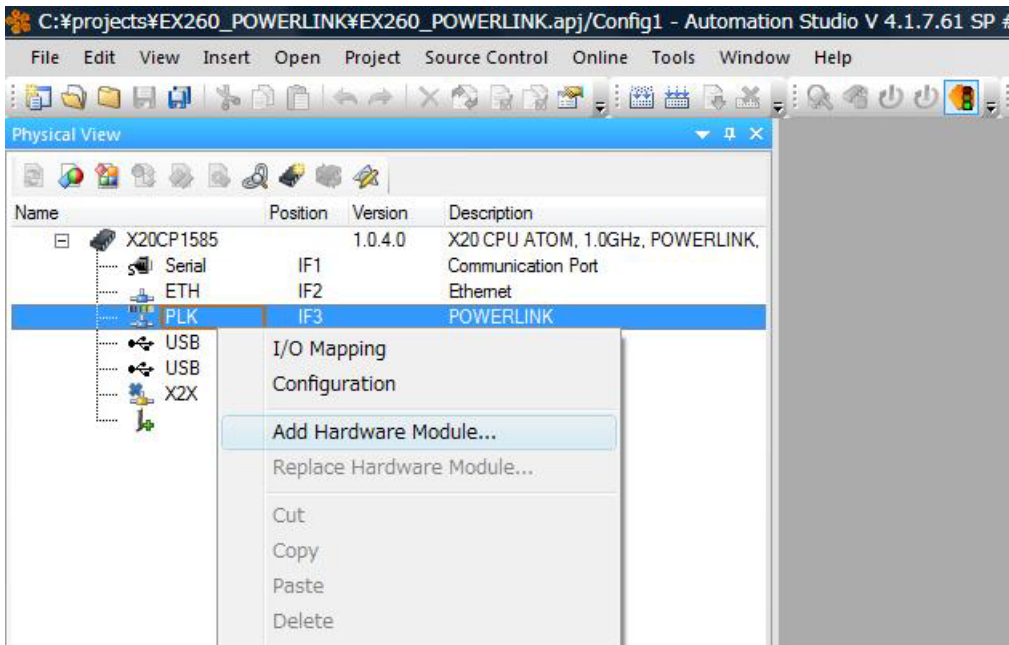

3) Double click or drag and drop the SI unit model number from the Hardware Catalog, and place it below "PLK".

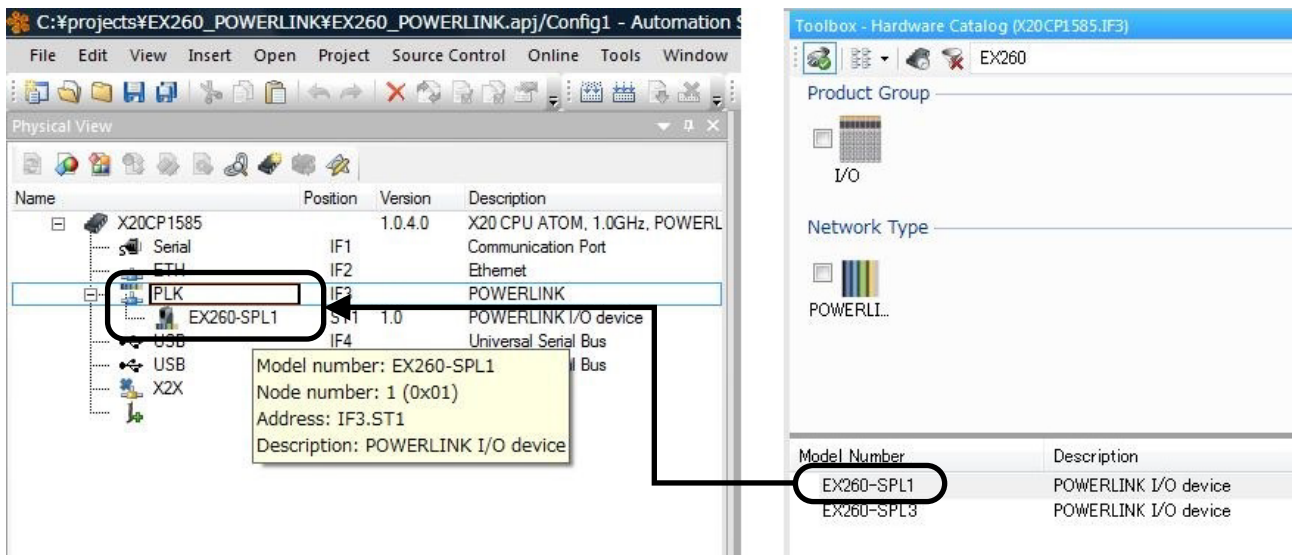

4) Select "Change Node Number" by right clicking SI unit, and input the Node ID number.

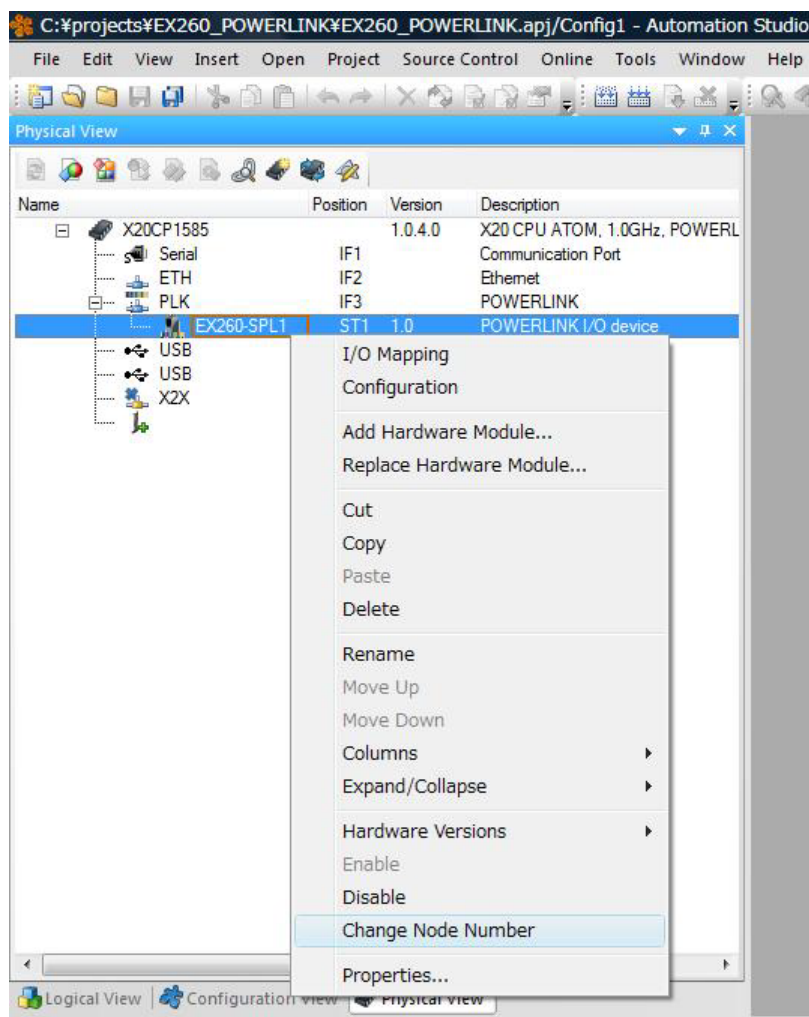

○Output number assignment
Output data

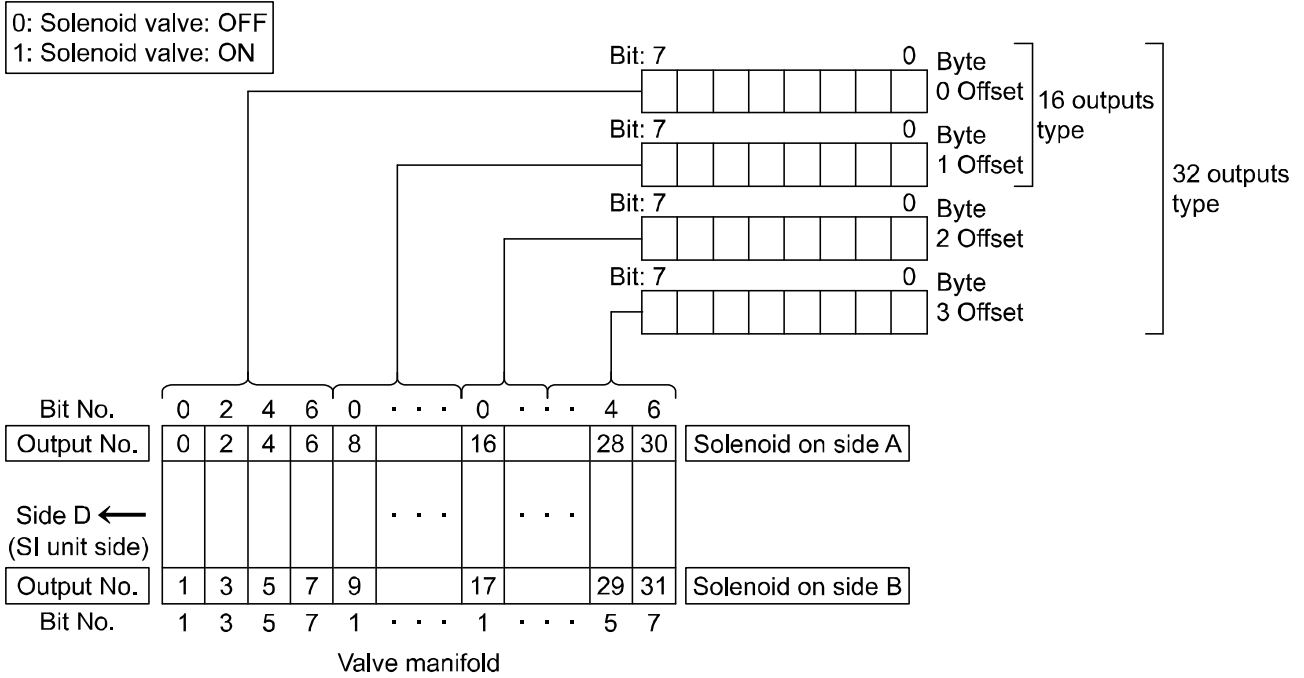

- *: The output numbering refers to the solenoid position on the manifold and starts at zero.
- *: Standard wiring of the manifold is for double-solenoid valves and the output number starts at the A side and then B side in that order as shown in the figure a.
If a single-solenoid valve is mounted on the standard wiring manifold, the output number for the B side valve is skipped.
- *: Custom wiring for mixed mounting single-solenoid valves and double-solenoid-valves can be specified with a Wiring Specification Sheet. Example wiring is shown in the figure b.
- *: Bit status "0" and "1" in the data corresponds to solenoid valve status OFF and ON (0: OFF, 1: ON), and the output number starts at zero from LSB (least significant bit).

fig.a

	No.	Station	No.
Double	4	3	5
Single	2	2	3 free
Double	0	1	1

fig.b

	No.	Station	No.
Double	3	3	4
Single	2	2	-
Double	0	1	1

Troubleshooting and Maintenance

○ Troubleshooting chart

When any malfunction is observed, it is recommended to perform the following troubleshooting.

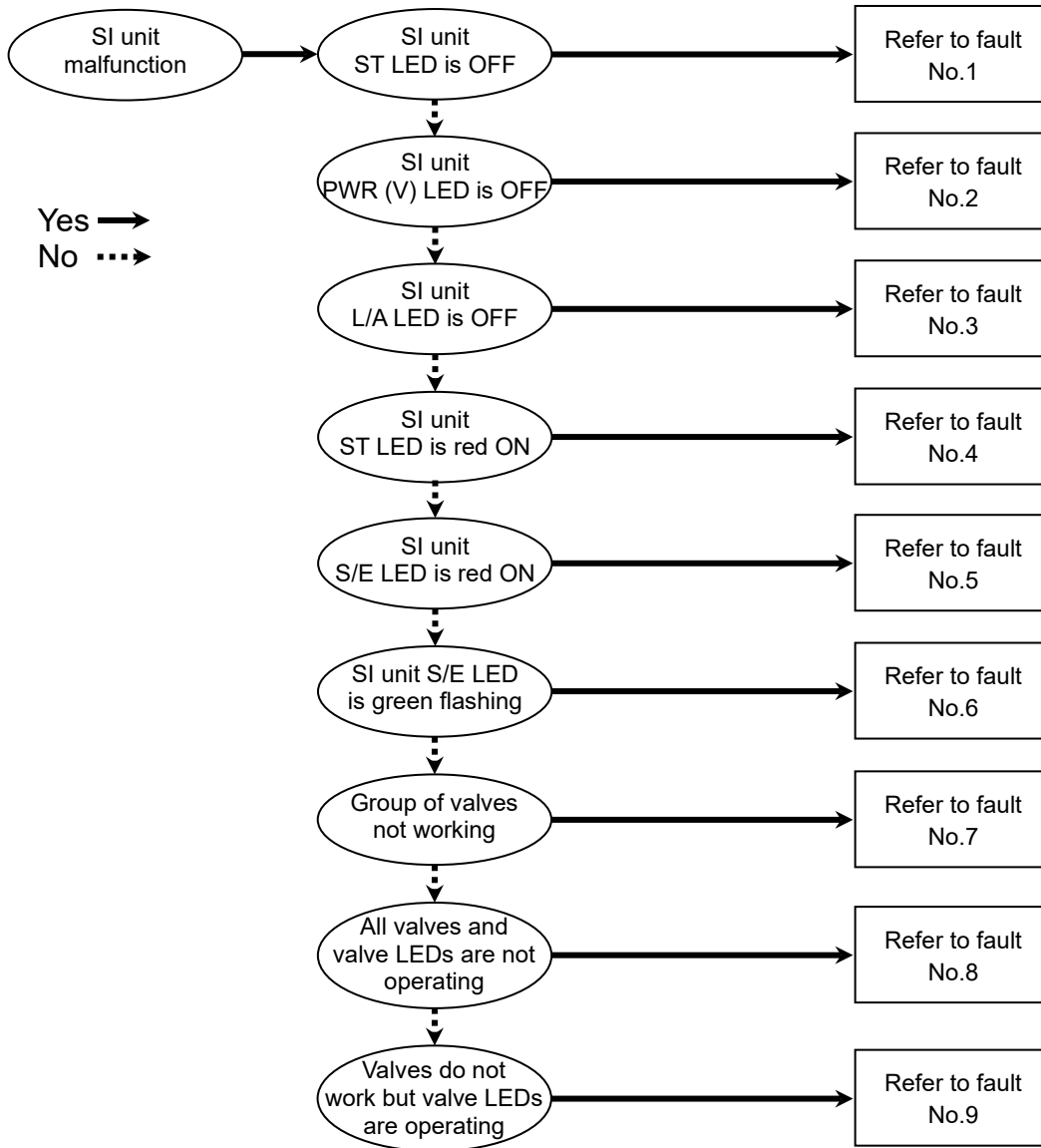

Troubleshooting table

Fault No.1

Fault	Probable cause	Recommended error handling	Recommended action
SI unit ST LED is OFF	Defective power cable wiring for SI unit operation	Check the condition of the power cable wiring to the SI unit.	Re-tighten the power cable. (Replace the cable if it is broken)
			Correct the power cable wiring layout.
	SI unit operating voltage is not supplied	Check the condition of the supply voltage to the SI unit.	Supply 24 VDC \pm 10% to the SI unit.
SI unit ST LED is OFF and S/E LED is red ON	Node ID number is outside range.	Check the Node ID setting.	Set the Node ID number from 1 to 239.

Fault No.2

Fault	Probable cause	Recommended error handling	Recommended action
SI unit PWR (V) LED is OFF	Defective power cable wiring for the solenoid valve	Check the condition of the power cable wiring for the valve.	Re-tighten the power cable. (Replace the cable if it is broken)
			Correct the power cable wiring layout.
	Load voltage for the valve is not supplied	Check the condition of the supply voltage for the valve.	Supply 24 VDC +10%/-5% to the valves.

Fault No.3

Fault	Probable cause	Recommended error handling	Recommended action
SI unit L/A LED is OFF	POWERLINK communication error between the SI unit and the upstream POWERLINK device.	Check the condition of the upstream POWERLINK device.	Supply power to the upstream POWERLINK device.
		Check the BUS IN side communication cable connections and check for broken wires.	Tighten the communication cable connection. (Replace the cable if it is broken)
		Check that there are no high voltage cables or equipment that generates noise around the communication cable and SI unit.	Take measures to keep the communication cable and SI unit away from noise sources.

Fault No. 4

Fault	Possible cause	Investigation method	Countermeasures
SI unit ST LED is red ON	Failure of SI unit.	Replace the SI unit and check that it operates normally.	Replace the SI unit.

Fault No.5

Fault	Probable cause	Recommended error handling	Recommended action
SI unit S/E LED is red ON	POWERLINK communication timeout	Check the communication cable connections and check for broken wires.	Tighten the communication cable connection. (Replace the cable if it is broken)
		Check that there is no high voltage cable or equipment that generates noise around the communication cable and SI unit.	Take measures to keep the communication cable and SI unit away from noise sources.

Fault No.6

Fault	Probable cause	Recommended error handling	Recommended action
SI unit S/E LED is green flashing	POWERLINK communication is not established	Check that the configuration information registered in the POWERLINK master matches the profile of the SI unit.	Configure the SI unit in the POWERLINK master software.
		Check that the Node ID is not duplicated.	Set the Node ID that is not duplicated.

Fault No.7

Fault	Probable cause	Recommended error handling	Recommended action
Group of valves not working	Too many valves	<p>Check if solenoid count does not exceed the allowable number. This depends on the SI unit model and valve series.</p> <p>Allowable solenoid number by valve series: SY/SV/S0700 series: 32 points VQC series: 24 points</p>	Keep the number of mounted solenoid valves within specification.

Fault No.8

Fault	Probable cause	Recommended error handling	Recommended action
All valves and valve LEDs are not operating	Poor connection between SI unit and valve manifold	Check if there are any loose screws making the connection between the SI unit and the valve manifold.	Tighten the screws with the specified tightening torque (i.e. 0.6 N•m) and make sure there is no gap between the SI unit and the valve manifold.
	Mismatch polarity between solenoid valve and SI unit output	Check if the solenoid valve common specification matches the output polarity of the SI unit.	Match polarity between solenoid valve and SI unit output.
	Defective solenoid valve	Follow the troubleshooting for the solenoid valve.	Same as left.

Fault No.9

Fault	Probable cause	Recommended error handling	Recommended action
Valves do not work but valve LEDs are operating	Mismatch polarity between solenoid valve and SI unit output	Check if the solenoid valve common specification matches the output polarity of the SI unit.	Match polarity between solenoid valve and SI unit output.

○Maintenance

Replacement of the SI unit

- Remove the M3 hexagon screws from the SI unit and release the SI unit from the valve manifold.
- Replace the SI unit.
- Tighten the screws with the specified tightening torque. (0.6 N•m)

Precautions for maintenance

- (1) Be sure to switch off the power.
- (2) Check there is no foreign matter inside the SI unit.
- (3) Check there is no damage and no foreign matter on the gasket.
- (4) Be sure to tighten the screws with the specified torque.

If the SI unit is not assembled properly, inside PCBs may be damaged or liquid and/or dust may enter into the unit.

○Assembly and disassembly of the SI unit

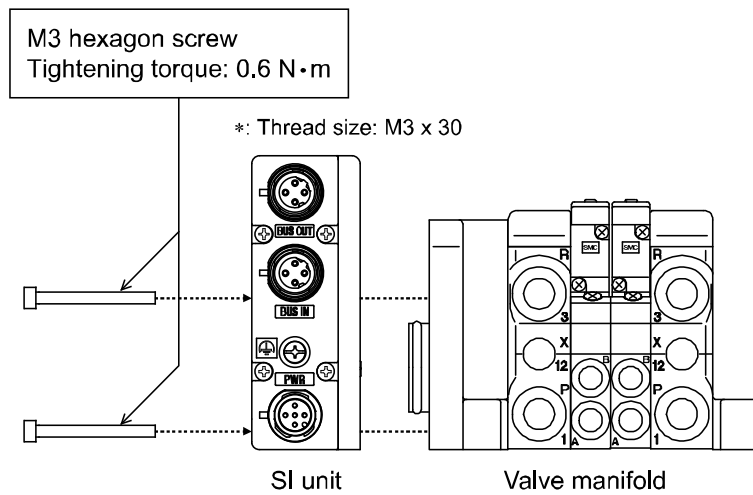

Specifications

■ Specifications

General specifications

Item	Specifications
Ambient temperature	-10 to +50 °C
Ambient humidity	35 to 85%RH (No condensate)
Ambient temperature for storage	-20 to +60 °C
Withstand voltage	500 VAC applied for 1 minute
Insulation resistance	500 VDC, 10 MΩ or more
Operating atmosphere	No corrosive gas
Enclosure	IP67
Weight	200 g or less
Standard	UL/CSA, CE marked (EMC directive, RoHS directive)

Electrical specifications

Item		Specifications
Current consumption in power supply voltage range	Current consumption of controller power supply	21.6 to 26.4 VDC 0.1 A max.
	Solenoid valve power supply	22.8 to 26.4 VDC 2.0 A or less, according to the solenoid valve station specification
Solenoid valve connecting specification	Output type	PNP (negative common) / source
	Connected load	Solenoid valve with surge voltage suppressor of 24 VDC and 1.5 W or less (manufactured by SMC)
	Insulation	Power supply for SI unit operation - Power supply for solenoid valve
	Residual voltage	0.4 VDC or less

Network communication specifications

Item		Specifications
Protocol		Ethernet POWERLINK
Transmission medium		Standard Ethernet cable (CAT5 or more) (100BASE-TX)
Transmission speed		100 Mbps
Transmission method		Half duplex
Node ID setting method		Rotary switch : from 1 to 239
Number of outputs	EX260-SPL1	32 outputs
	EX260-SPL3	16 outputs
Vendor ID		FFFF0007 hex

Connectable valve series

Valve Series	
SY series	SY3000, SY5000
VQC series	VQC1000, VQC2000, VQC4000
SV series	SV1000, SV2000, SV3000 (10 type tie-rod base)
S0700 series	S0700

o I/O Mapping

Input area mapping

Offset (Word)	Input data																			
	MSB								LSB	MSB							LSB			
	15								8	7							0			
0	L	L	L	L	L	L	L	L	L	L	L	L	L	L	L	L	SOLV	L	L	L

L: Low fixed (0)

Input status area

Input status area specifications

Item	Status	State	
SOLV	State of power supply for solenoid valve	0	Normal
		1	Abnormal (19 V or less)

Output area mapping

•For EX260-SPL1

Offset (Word)	Output data																
	MSB								LSB	MSB							LSB
	15								8	7							0
0	15	14	13	12	11	10	9	8	7	6	5	4	3	2	1	0	
1	31	30	29	28	27	26	25	24	23	22	21	20	19	18	17	16	

•For EX260-SPL3

Offset (Word)	Output data																
	MSB								LSB	MSB							LSB
	15								8	7							0
0	15	14	13	12	11	10	9	8	7	6	5	4	3	2	1	0	

■Dimensions

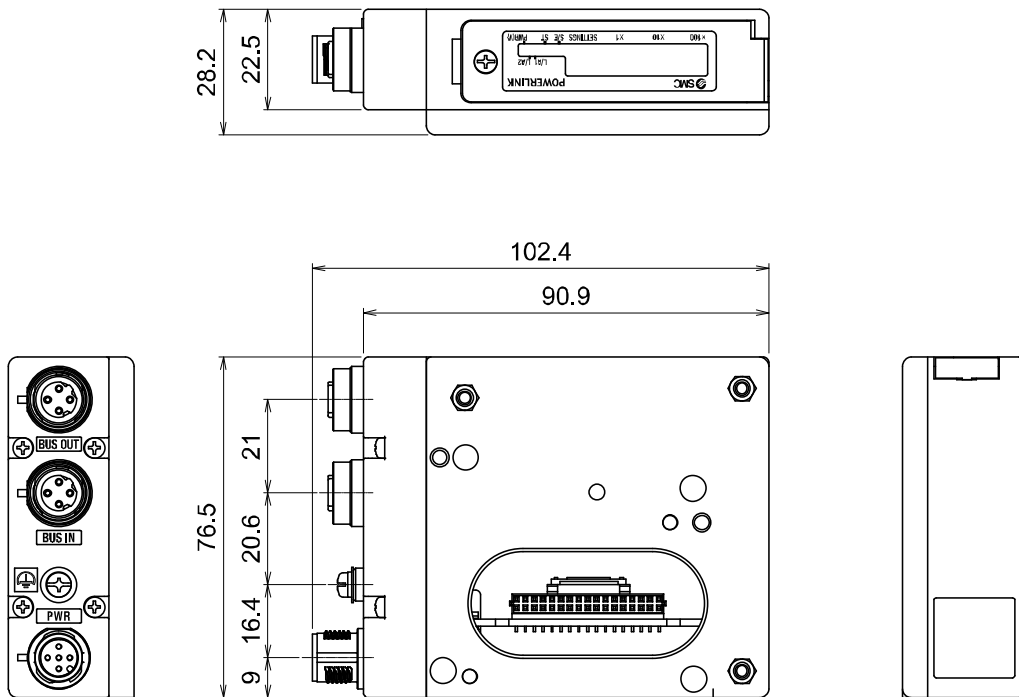

- If a fieldwireable connector is used for the power supply connection, and the SI unit is installed directly to a valve manifold, the cable connector's outer diameter should be $\phi 16$ mm or less. If it is a larger diameter, the connector will interfere with the mounting surface. Recommended cables are specified in the accessories section, on page 29.

Accessories

○Fieldbus interface connector

(1) Cable with communication connector (SPEEDCON)

Part number: PCA-1446566

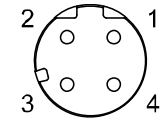

Plug connector
pin assignment
D-coded

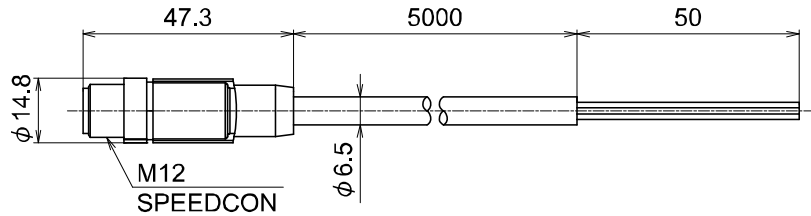

Item	Specifications
Connector	M12 Straight (SPEEDCON)
Cable length	5000 mm
Cable O.D.	φ6.5 mm
Nominal cross section	AWG22
Wire diameter (Including insulator)	1.5 mm
Min. bending radius (Fixed)	19.5 mm

Pin No.	Cable colour: Signal
1	Yellow : TD+
2	White : RD+
3	Orange: TD-
4	Blue : RD-

(2) Fieldwireable connector

Part number: PCA-1446553

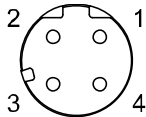

Plug connector
pin assignment
D-coded

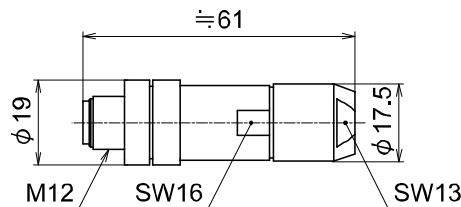

Applicable cable

Item	Specifications
Cable O.D.	φ4.0 to 8.0 mm
Electric wire cross section (Twist line)	AWG26 to 22

Pin No.	Colour on the feed holes	Cable colour	Signal
1	Orange/ White	YE=Yellow or OGWH=Orange/ White	TD+
2	Green/ White	WH=White or GNWH=Green/ White	RD+
3	Orange	OG=Orange	TD-
4	Green	BU=Blue or GN=Green	RD-

(3) Cable with communication connector

Part number: EX9-AC010EN-PSRJ

• Cable length (L)

01	1000 [mm]
02	2000 [mm]
03	3000 [mm]
05	5000 [mm]
10	10000 [mm]

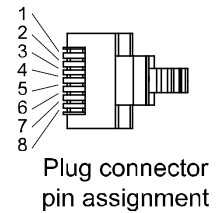
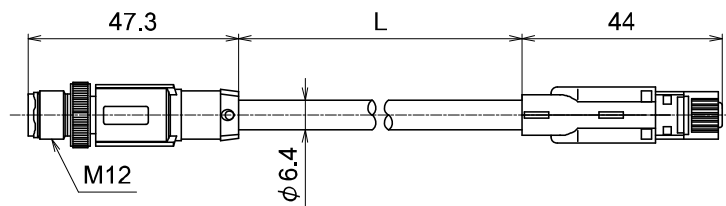
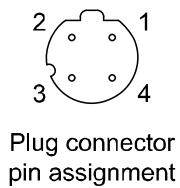

Item	Specifications
Connector	M12 Straight ↔ RJ45
Cable O.D.	φ6.4 mm
Nominal cross section	AWG26
Min. bending radius (Fixed)	26 mm

(4) Seal cap

Part number: EX9-AWTS

This cap is used to protect the M12 connector opening when the connector is not used. When the "BUS OUT" connector is not used, the seal cap can keep the SI unit under IP67 rated protection.

(One seal cap will be attached to the SI unit when shipped from factory.)

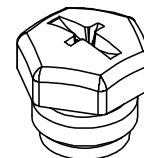

Description	Part No.	Specification
Seal cap	EX9-AWTS	For M12 connector socket: 10 pcs.

- Power supply connector
- (1) Cable with power supply connector

Part number: EX500-AP010-S

Connector specifications

S	Straight
A	Angle

Cable length (L)

1	1000 [mm]
5	5000 [mm]

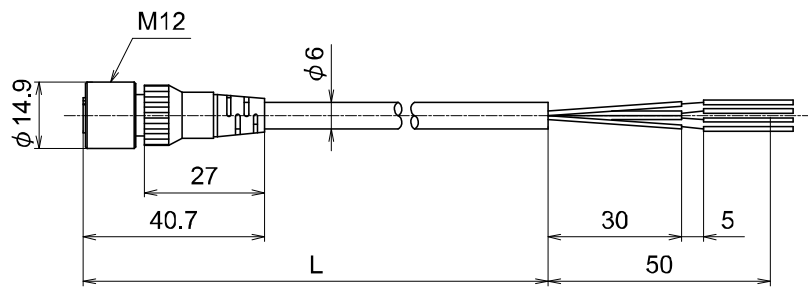

EX500-AP0#0-S

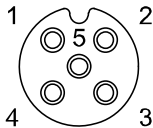

Socket connector
pin assignment
A-coded (Normal key)

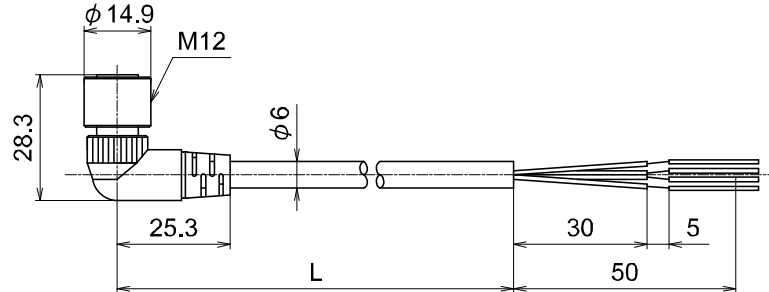

EX500-AP0#0-A

Item	Specifications
Cable O.D.	φ6 mm
Nominal cross section	AWG22
Wire diameter (Including insulator)	1.5 mm
Min. bending radius (Fixed)	40 mm

Pin No.	Cable colour: Signal
1	Brown: 24 VDC (For solenoid valve)
2	White : 0 V (For solenoid valve)
3	Blue : 24 VDC (For control)
4	Black : 0 V (For control)
5	Gray : Not connected

(2) Cable with power supply connector (SPEEDCON)

Part number: PCA-1401804

• Cable length (L)

4	1500 [mm]
5	3000 [mm]
6	5000 [mm]

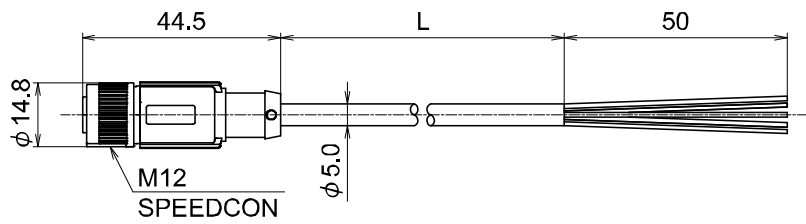
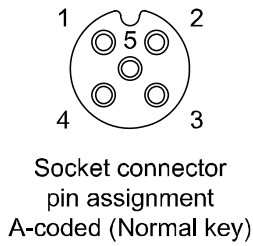

Item	Specifications
Connector	M12 Straight (SPEEDCON)
Cable O.D.	φ5 mm
Nominal cross section	AWG22
Wire diameter (Including insulator)	1.27 mm
Min. bending radius (Fixed)	21.7 mm

Pin No.	Cable colour: Signal
1	Brown: 24 VDC (For solenoid valve)
2	White : 0 V (For solenoid valve)
3	Blue : 24 VDC (For control)
4	Black : 0 V (For control)
5	Green/Yellow: Not connected

Revision history
A: Contents revised in several places. [June 2022]

SMC Corporation

4-14-1, Sotokanda, Chiyoda-ku, Tokyo 101-0021 JAPAN

Tel: + 81 3 5207 8249 Fax: +81 3 5298 5362

URL <https://www.smcworld.com>

Note: Specifications are subject to change without prior notice and any obligation on the part of the manufacturer.
© 2018-2022 SMC Corporation All Rights Reserved

