



Operation Manual

THERMO-CON

Model No.

HEC006-W2A

HEC006-W2B

HEC012-W2A

HEC012-W2B

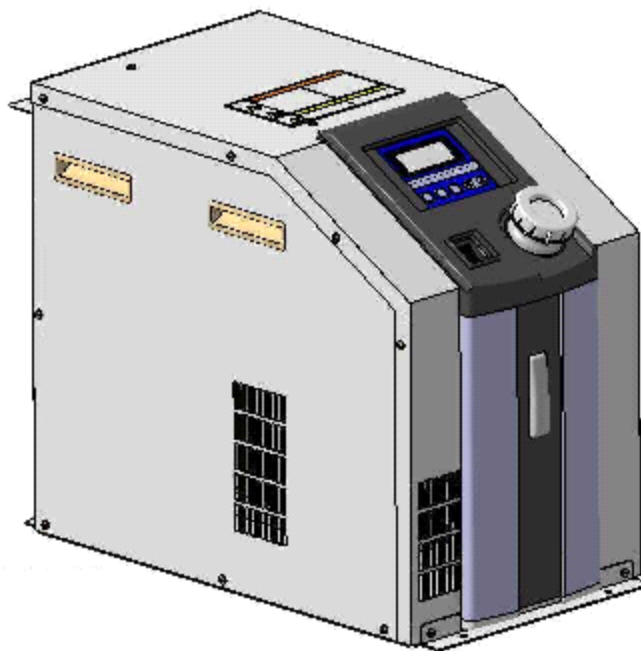

Keep this manual available at all times.

Preface

Thank you very much for purchasing SMC Thermo-con.

This manual is described for operation of this unit. Please use this manual for efficient and long use of this unit. Be sure to read this manual efficiently for your deep understanding of overview and safety of this unit before installation or carrying out the relevant operations of this unit. Especially, you need to follow the instructions about "Danger", "Warning" and "Caution".

Packaged items

Upon receipt of the ordered product, immediately check that the following components have been included.

No.	Item	Qty.
1	Product	1
2	Power supply cable	1
3	Foot (mounting bracket)	2
4	Operation Manual	1

Warning and Precautions on Handling

- 1) Be sure to read this Warning and Precautions on Handling carefully.
- 2) This manual provides explanations of the installation and operation of this product. Only those who have a thorough understanding of the operating procedures and who have basic knowledge and skills in handling industrial equipment are qualified to perform installation and operation.
- 3) The contents of this manual and the related documents supplied with this product shall be neither regarded as a provision of the contract nor utilized to correct or modify the existing agreements, commitments and relations.
- 4) Copying, duplicating or transferring any part or the entirety of this manual without the prior permission of SMC is strictly prohibited.
- 5) This product has been developed for physical, chemical, and industrial facility applications. When it is used for applications that require the consideration additional safety precautions, e.g., for medical devices, investigate the safety needs for the application at the customer's site before use.

<Contact>

If you have any questions or are unclear about any of the content of this manual, please contact the following department.

Product Development Div. 6, Engineering Headquarters
Japan Technical Center, SMC Corporation,
Address: 4-2-2 Kinunodai, Tsukubamirai-city, Ibaraki-ken, 300-2493

TEL: +81 297-52-6666

FAX: +81 297-20-5007

E-mail: kaihatsu_6_g3@smcjpn.co.jp

Note: The contents of this manual are subject to change without

Scope of warranty and liability to the Thermo-con

Please thoroughly understand the following statements for product guarantee.

(1) Product warranty

Except for the situations stated in item 3, the quality of this product is guaranteed.
If the product fails during the guarantee period stated below, the failed product will be repaired in principle, and guaranteed to the extent of replacement without charge.

(2) Warranty period

Warranty period with free of charge of this unit is for 12 months after shipment from SMC.

(3) Expectations

We don't take any responsibility of warranty decided in (1) regarding the troubles or damages stated below. Repair for the trouble or damage should be paid by the customer.

Trouble and damages caused by natural disaster (fire, flood, lightning strike and others)

Troubles and damages caused by reconstruction without our approval.

Troubles and damages caused by works or operations with ignoring the instructions of the manual.

Trouble and damages caused by wrong handling.

Failure caused by the repair that is done by other companies other than SMC.

Failure caused by elapse of the time. (natural discoloration of coated face / plated face.)

Sensuous phenomenon nothing to do with function. (sound, noise, vibration and others)

Secondary damages such as reduction of production caused by malfunction and failure etc. of this unit.

(4) Expendable parts as well as parts, labor, transportation etc. necessary for maintenance of the unit after warranty period with free of charge shall be on your account.

Contents

	Page No.
1 INTRODUCTION -----	1-1
1.1 SCOPE AND GENERAL DESCRIPTION OF USE -----	1-1
1.2 OPERATION BY EXTERNAL COMMUNICATION -----	1-1
1.3 CONTENTS OF OPERATION MANUAL -----	1-2
2 SAFETY INSTRUCTIONS -----	2-1
2.1 BEFORE USING THE THERMO-CON -----	2-1
2.1.1 SAFETY TRAINING -----	2-1
2.1.2 IDENTIFICATION OF "DANGER", "WARNING", "CAUTION" AND "NOTE" -----	2-1
2.2 "WARNING" LABEL AND "CAUTION" LABEL -----	2-3
2.2.1 THE POSITION OF ATTACHING "WARNING" LABEL AND "CAUTION" LABEL -----	2-3
2.3 PRECAUTIONS FOR RUNNING -----	2-4
2.3.1 FOR SAFETY -----	2-4
2.3.2 SAFETY INTERLOCK -----	2-5
3 CAUTION ON INSTALLATION -----	3-1
3.1 ENVIRONMENT -----	3-1
3.2 INSTALLATION -----	3-2
3.3 MOUNTING -----	3-3
3.4 PIPING -----	3-4
3.5 QUALITY OF RADIATING WATER -----	3-4
4 UNIT OVERVIEW -----	4-1
4.1 METHOD OF DISPLAYING MODEL -----	4-1
4.2 MANUFACTURING YEARS METHOD OF DISPLAY -----	4-1
4.3 MODEL No. LABEL -----	4-2
4.4 APPEARANCE -----	4-3
4.4.1 HEC006 -----	4-3
4.4.2 HEC012 -----	4-4
4.5 OPERATING PRINCIPLES -----	4-5
4.5.1 CONSTRUCTION AND PRINCIPLE OF THERMO MODULE -----	4-5
4.5.2 CONSTRUCTION OF TEMPERATURE CONTROLLING DEVICE -----	4-6
4.5.3 ELETRICAL DIAGRAM -----	4-7
4.6 FUNCTIONS -----	4-9
4.6.1 AUTO TUNING -----	4-9
4.6.2 OFFSET FUNCTION -----	4-9
4.6.3 LEARNING CONTROL FUNCTION -----	4-9

4.6.4	EXTERNAL TUNE CONTROL FUNCTION	4-9
4.6.5	TEMPERATURE SENSOR FINE CONTROL FUNCTION	4-9
4.6.6	SETTING VALUE MEMORY FUNCTION	4-9
4.6.7	UPPER/LOWER TEMPERATURE LIMIT ALARM FUNCTION	4-9
4.7	AUTOTUNING FUNCTION	4-10
5	NAMES AND FUNCTIONS OF COMPONENTS	5-1
5.1	HEC006	5-1
5.2	HEC012	5-2
5.3	OPERATION PANEL	5-3
5.4	DISPLAY	5-4
5.5	RESERVOIR CAP	5-4
6	SPECIFICATIONS	6-1
6.1	SPECIFICATION TABLE	6-1
6.2	PERFORMANCE CHART	6-3
6.2.1	PERFORMANCE OF HEC006	6-3
6.2.2	PERFORMANCE OF HEC012	6-5
7	PREPARATION FOR OPERATION	7-1
7.1	PIPING	7-1
7.1.1	PREPARATION FOR RADIATING WATER	7-1
7.1.2	PREPARATION FOR RECIRCULATING FLUID	7-2
7.2	WIRING	7-3
7.2.1	POWER SUPPLY	7-3
7.2.2	CIRCUIT BREAKER	7-3
7.2.3	GROUNDING	7-3
7.2.4	AVOIDANCE OF PARALLEL WIRING	7-3
7.2.5	CONNECTION OF VARIOUS CONNECTORS AND POWER SUPPLY CABLE	7-3
7.3	SUPPLY OF RECIRCULATING FLUID	7-4
7.4	CHECK - REPAIR	7-5
7.4.1	DAILY CHECK	7-5
7.4.2	CHECK AFTER SEISMIC VIBRATION AND IMPACT	7-6
7.4.3	REPAIR AND MAINTENANCE	7-6
8	OPERATION	8-1
8.1	START OF OPERATION	8-1
8.1.1	CONFIRMATION BEFORE OPERATION	8-1
8.1.2	SETTING OF VALUES	8-1
8.1.3	CAUTIONS FOR OPERATION CONTROL	8-1
8.2	HOW TO OPERATE	8-2

8.3	SETTING MODE, LEVEL 1	8-3
8.3.1	HOW TO ENTER AND RETURN	8-3
8.3.2	AVAILABLE MODE IN LEVEL 1	8-3
8.4	SETTING MODE, LEVEL 2	8-4
8.4.1	HOW TO ENTER AND RETURN	8-4
8.4.2	AVAILABLE MODE IN LEVEL 2	8-4
8.5	SETTING MODE, LEVEL 3	8-5
8.5.1	HOW TO ENTER AND RETURN	8-5
8.5.2	AVAILABLE MODE IN LEVEL 3	8-5
8.6	DETAIL OF SETTING MODE LEVEL	8-6
8.6.1	SETTING MODE, LEVEL 1	8-6
8.6.2	SETTING MODE, LEVEL 2	8-8
8.6.3	SETTING MODE, LEVEL 3	8-10
9	ALARM	9-1
9.1	HOW TO IDENTIFY ALARM	9-1
9.2	ALARM INDICATION	9-2
9.3	HOW TO RESET ALARM	9-3
9.4	ALARM CODE LIST	9-3
9.5	TROUBLESHOOTING	9-5
10	APPENDIX	10-1
10.1	SIGNAL AND STYLE OF CONNECTORS	10-1
10.2	POWER SUPPLY CABLE	10-2
10.3	CALCULATION OF DEW POINT (FROM PSYCHOMETRIC CHART)	10-3

Figure List

	Page No.
FIG. 2-1 THE POSITION OF ATTACHING "WARNING" LABEL AND "CAUTION" LABEL	2-3
FIG. 2-2 DETAIL OF "WARNING" LABEL AND "CAUTION" LABEL	2-3
FIG. 3-1 INSTALLATION ENVIRONMENT	3-2
FIG. 3-2 FOOT MOUNTING SCREWS	3-3
FIG. 3-3 MOUNTING	3-3
FIG. 4-1 POSITION OF MODEL NO. LABEL	4-2
FIG. 4-2 LEGEND OF MODEL NO. LABEL	4-2
FIG. 4-3 OUTSIDE DRAWINGS OF HEC006	4-3
FIG. 4-4 OUTSIDE DRAWINGS OF HEC012	4-4
FIG. 4-5 CONSTRUCTION AND PRINCIPLE OF THERMO MODULE	4-5
FIG. 4-6 RECIRCULATING FLUID AND RADIATING WATER CIRCUIT	4-6
FIG. 4-7 ELECTRICAL DIAGRAM (HEC006)	4-7
FIG. 4-8 ELECTRICAL DIAGRAM (HEC012)	4-8
FIG. 5-1 COMPONENTS OF HEC006	5-1
FIG. 5-2 COMPONENTS OF HEC012	5-2
FIG. 5-3 OPERATION PANEL	5-3
FIG. 5-4 DISPLAY	5-4
FIG. 5-5 RESERVOIR CAP	5-4
FIG. 6-1 COOLING CAPACITY OF HEC006	6-3
FIG. 6-2 HEATING CAPACITY OF HEC006	6-3
FIG. 6-3 PUMP CAPACITY OF HEC006	6-4
FIG. 6-4 PRESSURE LOSS OF HEC006	6-4
FIG. 6-5 COOLING CAPACITY OF HEC012	6-5
FIG. 6-6 HEATING CAPACITY OF HEC012	6-5
FIG. 6-7 PUMP CAPACITY OF HEC012	6-6
FIG. 6-8 PRESSURE LOSS OF HEC012	6-6
FIG. 9-1 ALARM INDICATION IN THE EVENT ERR14 ARISES	9-2
FIG. 9-2 ALARM INDICATION IN THE EVENT ERR14 ARISES DURING PB RANGE SETTING INPUT	9-2
FIG. 9-3 ALARM INDICATION IN THE EVENT TEMP. UPPER AND LOWER LIMIT ARISES	9-2
FIG. 10-1 MOISTURE AIR DIAGRAM	10-3

Table List

	Page No.
TABLE 2-1 DIVISION OF DANGER, WARNING, CAUTION, AND NOTE -----	2-2
TABLE 2-2 MEANING OF A SYMBOLS -----	2-2
TABLE 2-3 SAFETY INTERLOCK LIST (PART 1) -----	2-6
TABLE 2-4 SAFETY INTERLOCK LIST (PART 2) -----	2-6
TABLE 3-1 QUALITY STANDARD FOR WATER (TAP WATER) -----	3-4
TABLE 5-1 FUNCTION OF COMPONENTS -----	5-3
TABLE 6-1 SPECIFICATIONS OF HEC006 -----	6-1
TABLE 6-2 SPECIFICATIONS OF HEC012 -----	6-2
TABLE 8-1 AVAILABLE MODE IN LEVEL 1 -----	8-3
TABLE 8-2 AVAILABLE MODE IN LEVEL 2 -----	8-4
TABLE 8-3 AVAILABLE MODE IN LEVEL 3 -----	8-5
TABLE 9-1 ALARM INFORMATION -----	9-1
TABLE 9-2 RESET OF ALARM -----	9-3
TABLE 9-3 ALARM CODE LIST -----	9-3
TABLE 9-4 TROUBLESHOOTING -----	9-5
TABLE 10-1 SIGNAL AND STYLE OF CONNECTORS -----	10-1
TABLE 10-2 POWER SUPPLY CABLE -----	10-2

Abbreviations

Abbreviation (The order of ABC)	Meaning
AC	Alternating Current
AT	Auto Tuning
DC	Direct Current
EPDM	Ethylene Propylene Diene Monomer
ERR	Error
IEC	International Electrotechnical Commission
LCD	Liquid Crystal Display
PE (Electricity)	Protective Earth
PE (Material)	Polyethylene
PID	Proportional,Integral,Differentiate
PPS	Polyphenylene Sulfide
PV	Process Value
RET	Return
RXD	Received Data
SEL	Select
SER (No.)	Serial (No.)
SG	Signal Ground
SUS	Special Use Stainless steel
SV	Setting Value
Temp.	Temperature
TXD	Transmitted Data
WRN	Warning

GALDEN and Fluorinert are a trade mark of Solvay Solexis Inc. and 3M respectively.

1 Introduction

The definition and construction of operation manual are described below.

1.1 Scope and general description of use

The operation manual applies to operation and installation method of SMC-brand Thermo-con. It aims easier understanding of operational and Installation information of the Thermo-con. Before any operation and Installation of this unit, be sure to read this operation manual carefully and understand the contents well.

Read this operation manual with taking a look at the unit to facilitate your understanding.

1.2 Operation by external communication

It complies with communication standard RS-232C or RS-485 and can have a cable with length up to 15m or 500m.

The content which can be communicated is as follows.

- 1) Setting and reading of target temperature
- 2) Reading of the value detected by temperature sensor
- 3) Reading of warning status
- 4) Setting and reading of off-set value

For operation by communication, it is necessary to order "Communication Specifications".

1.3 Contents of operation manual

1) Chap. 1 Introduction

The definition and use of operation manual are described.

2) Chap. 2 Safety Instructions

Safety instruction, caution note, danger and warning, warning label and caution label and safety interlock used in this unit are described.

3) Chap.3 Caution on Installation

The precautions for setting up and mounting this unit are described.

4) Chap. 4 Unit Overview

Describes the outlook of this unit and operation overview.

5) Chap. 5 Names and Functions of Components

The description and function of the parts in this unit are mentioned.

6) Chap. 6 Specifications

The specifications of this unit are described.

7) Chap. 7 Preparation for Operation

The precautions for operation of this unit are described by each part.

8) Chap. 8 Operation

The method for operation of this unit is explained.

9) Chap. 9 Alarm

The alarms, which arise in this unit, are explained.

10) Chap. 10 Appendix

The signal of connectors and the method for calculating dew points are described.

2 Safety Instructions

2.1 Before using the Thermo-con

This chapter is dedicated for your safety during your relation with the unit.

The Thermo-con is operated under high voltage.

Therefore, not only those who operate the unit, but those who are in charge of service work related to the unit and who work nearby the unit should read carefully and thoroughly understand descriptions related to safety in this manual before starting the work.

2.1.1 Safety training

This manual is not a general manual for safety and hygiene education that safety and hygiene tutors are supposed to conduct.

Anyone working with or near this unit are requested to be fully trained in aspect of recognition of the danger inherent to the unit and the safety countermeasures.

A manager is responsible for strict compliance to the safety standard in whole system, but individual person in charge of operation and maintenance should take responsibility for that accompanying the daily work and should care for the safety of its working location and environment.

Operators and maintenance responsible should secure the safety of workshops and their environment before work.

The work training concerning the unit should take place after the sufficient tutorage on safety. The training must not be carried without consideration to safety.

2.1.2 Identification of “Danger”, “Warning”, “Caution” and “Note”

The notifications given in this operation manual aims to assure safe and correct operation to prevent injury of operators and also to prevent damage of product. The notifications are grouped into four categories, “Danger”, “Warning”, “Caution”, and “Note”, which indicate the magnitude of hazard and damage and also the degree of emergency. Both notifications contain critical matter on safety, so they shall be carefully observed.

DANGER, WARNING, CAUTION and NOTE signs are in order according to seriousness (DANGER> WARNING> CAUTION> NOTE).

Table2-1 Division of DANGER, WARNING, CAUTION, and NOTE







 <p>DANGER</p>	<p>These paragraphs document hazards that would cause serious or even fatal injuries to workers if you handle improperly or fail to obey items necessary to avoid hazards during operations.</p>
 <p>WARNING</p>	<p>These paragraphs document hazards that might cause serious injuries to workers if you do not carry out appropriate procedure or fail to obey warnings during operations.</p>
 <p>CAUTION</p>	<p>These paragraphs document hazards that might cause serious injuries to workers or might damage the unit, installed devices and products it produce if you do not carry out appropriate procedure or fail to obey caution during operations.</p>
<p>NOTE</p>	<p>These paragraphs document performance of the unit that is recommended to be known, mistakes that likely to happen, or anything that might damage products themselves if not obeyed or corrected during operations.</p>

Table2-2 Meaning of symbols

Symbol	Meaning
	<p>Attention, consult accompanying documents</p>
	<p>Caution, risk of electric shock</p>
	<p>Caution, handling of heavy object may affect human body. It should be handled by two or more workers.</p>

2.2 “Warning” label and “Caution” label

This unit contains is provided with “Warning” label and “Caution” label to keep its operator safe. Check the contents and position of these labels before starting the work.

⚠WARNING

Read contents of alert warning and caution labels carefully and keep them in mind.

Do not peel off or rub alert warning and caution labels.

Confirm locations of alert warning and caution labels.

2.2.1 The position of attaching “Warning” label and “Caution” label

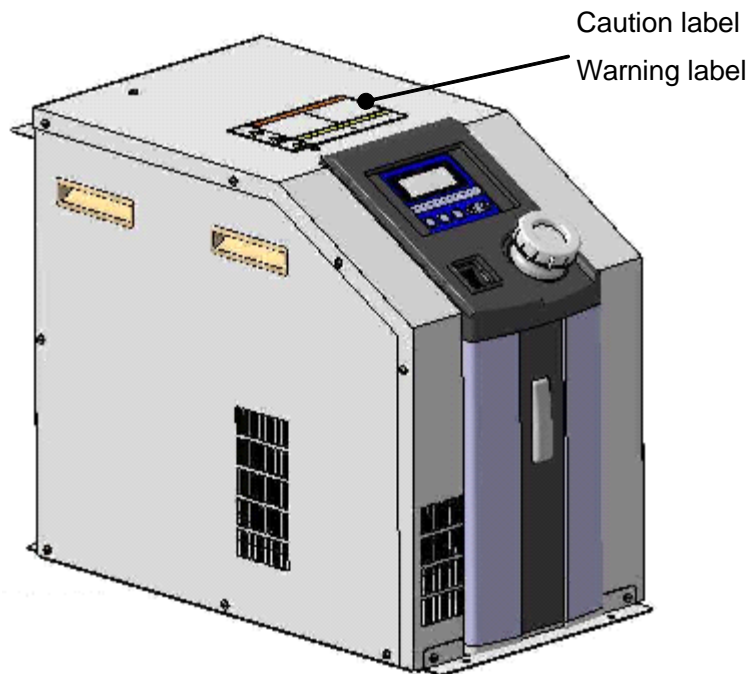

Fig. 2-1 The position of attaching “Warning” label and “Caution” label



Fig. 2-2 Detail of “Warning” label and “Caution” label

2.3 Precautions for running

2.3.1 For safety

▲WARNING

The unit shall be handled by only specialists. Transportation, installation and maintenance including dangerous works shall be done by persons who have full knowledge and experience on the unit and the system. Cover panels of this unit shall be opened only by qualified service technicians or qualified personnel.

▲WARNING

Do not disassemble or retrofit this product.

▲WARNING

Recirculating fluid should be handled after checking protection devices and first-aid actions on the Material Safety Data Sheet (MSDS) of the using recirculating fluid.
To handle fluorinated fluid, it is necessary to wear protection devices such as safety glasses, gloves, working clothes or rubber aprons.

▲WARNING

Other Precautions If an abnormal matter, such as abnormal noise or smoke, or water leakage appeared, act as follows.

- Shut down power.
 - Stop water feed and supply
 - Call us for repair.
-

▲CAUTION

Please do not use the device which generates the electromagnetic radiation such as cellular phones beside the unit. There is a possibility that the unit mis-operates.

2.3.2 Safety Interlock

This is the function to protect personal, to restrict operation, which may cause damage to this unit or facility around, and to remove dangers related with safety and sanitation.

This unit has several interlock functions, which activates when danger operation or condition occurs to stop operation and make it safe.

▲ DANGER

During operation or maintenance of this unit, do not disable interlock function of each device. Otherwise it becomes improper and may cause unexpected personnel injury and damage this unit.

▲ DANGER

Turning the power switch ON/OFF

When you turn on/off the power, observe its procedure. Mistaking it may cause unexpected action and danger.

When you maintain, clean or act against trouble, turn off source power.

Re-supply of the power after having a trouble should be done after checking the cause and taking countermeasures and confirming safety.

▲ CAUTION

When the power supply is restarted after turned off once, keep time interval at least 3sec. The restart of supply within that interval may break the unit.

Table2-3 Safety interlock list (Part 1)

No.	Description	Part	Cause
1	Overheat in Heat Exchanger	Thermostat	Detects abnormal heat in heat exchanger.
2	Switching power supply failure	Internal circuit	Detects abnormal current/voltage or heat or fanlock.
3	Low recirculating fluid level	Level sensor	Detects lowering of recirculating fluid level in reservoir.
4	Detection of breakage of temp. sensor	Controller internal circuit	Detects breakage and short circuit of temp. sensor and cables.
5	Excessive temp. increase	Controller internal circuit	Detects temp. input value not less than 70 °C.
6	Excessive temp. decrease	Controller internal circuit	Detects temp. input value not more than 0 °C.
7	Abnormal output (Overload)	Controller internal circuit	Works when temp. change is smaller than over load detection temp.(selected between 0.1 to 9.9 °C) even if 100% output continues during overload detection time (selected between 0 to 99min.) When 0 is set, the alarm doesn't arise.
8	Pump failure	Thermal overload relay	Detects the pump stop by the overload. (HEC012 only)

Table2-4 Safety interlock list (Part 2)

No.	Description	Condition of unit	Indication	How to reset
1	Overheat in Heat Exchanger	Shuts off power supply to the Heat exchanger, Pump.	Error indication on display. (ERR14)	Restart power supply
2	Switching power supply failure	Shuts off power supply to the Heat exchanger, Pump.	Error indication on display. (ERR11)	Restart power supply
3	Low recirculating fluid level	Shuts off power supply to the Heat exchanger, Pump.	Error indication on display. (ERR20)	Restart power supply
4	Detection of breakage of temp. sensor	Shuts off power supply to the Heat exchanger, Pump.	Error indication on display. (ERR17)	Restart power supply
5	Excessive temp. increase	Shuts off power supply to the Heat exchanger, Pump.	Error indication on display. (ERR12)	Restart power supply
6	Excessive temp. decrease	Shuts off power supply to the Heat exchanger, Pump.	Error indication on display (ERR13)	Restart power supply
7	Abnormal output (Overload)	The unit continues controlling.	Error indication on display (ERR15)	Restart power supply
8	Breakage of external temp. sensor	The unit continues controlling by normal control mode.	Error indication on display (ERR18)	Restart power supply
9	Pump failure	Shuts off power supply to the Heat exchanger, Pump.	Error indication on display. (ERR16)	Restart power supply

3 Caution on Installation

▲WARNING

Pay special attention to keep safety of human body during installation and transportation of the unit.

▲ CAUTION

This product is heavy. It should be handled by two or more workers at the time of installation and transfer.

▲ CAUTION

Only the trained person with knowledge and experience can perform the possibly dangerous work associated with installation, transportation and maintenance.

3.1 Environment

The Thermo-con shall be installed on the following environments.

- 1) The installations without exposure to water, oil or any chemical spills, or environment.
- 2) The installations, which allows the Thermo-con to become stable horizontally.
- 3) The installations, which doesn't interfere the suction and discharge port, required for refrigerant via fan. Do not install the unit in an enclosed container.
- 4) The installations without exposure to corrosive or flammable gas. (The unit is not explosion proof.)
- 5) The installations with ambient temp. range of 10 to 35°C and humidity range of 35 to 80%. No dew condensation is allowed on the unit. The detail of dew condensation is shown on "10.3 Calculation of Dew Point".
- 6) The installations without effect from noise source (such as discharging equipment, large relay and thyristor).
- 7) The installations with enough space between power supply cable or communication cable of the Thermo-con and power line of other equipments.
- 8) The installations without strong electrical or magnetic emission.
- 9) The installations, which allows power supply, ground to be made properly.
- 10) The installations free from the material such as silicone, which may generate harmful gas.
- 11) Do not use or keep in outdoor, the place with the direct sunshine strikes and the radiation heats. That causes the breakdown.

▲ CAUTION

This product can be used only in environments with a pollution degree of 1 or 2.

3.2 Installation

If the air inlet of Thermo-con and the outlet opening is not enough, the performance and product life might be degraded due to a decline of air flow. Install Thermo-con following condition. At the same time, when ambient temperature is in excess of 35°C, ventilate and exhaust air to prevent the ambient temperature from rising.

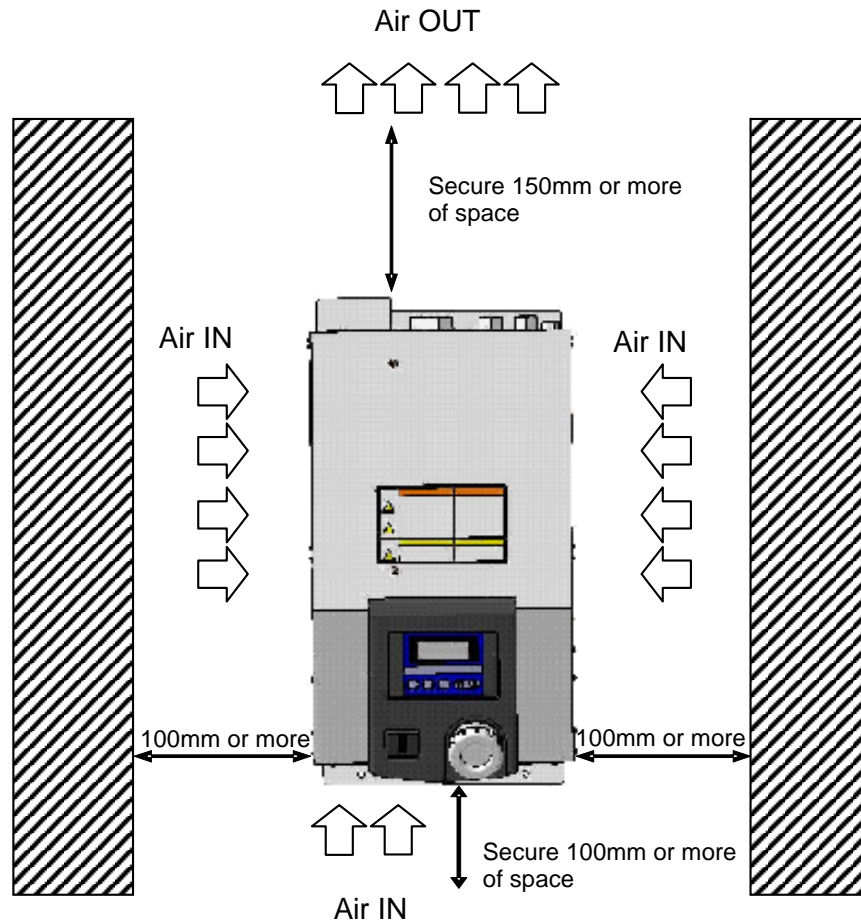

Fig. 3-1 Installation environment

The leakage from a thermo-con may damage peripheral equipment. Install a drain pan under the Thermo-con to store the leaked liquid. Furthermore, mount devices like a leak sensor on the installed drain pan to detect leakage so that it can alert operators around the area.

3.3 Mounting

Thermo-con is preferably mounted as follows.

- 1) A fixing foot is prepared for the thermo-con (accessory). Mount it on the thermo-con body before use.
 Remove the 2pcs of screws on the front and back of the thermo-con respectively, and mount the attached foot.
 Tighten those screws with the torque of 1.5Nm when installing it on the thermo-con body.

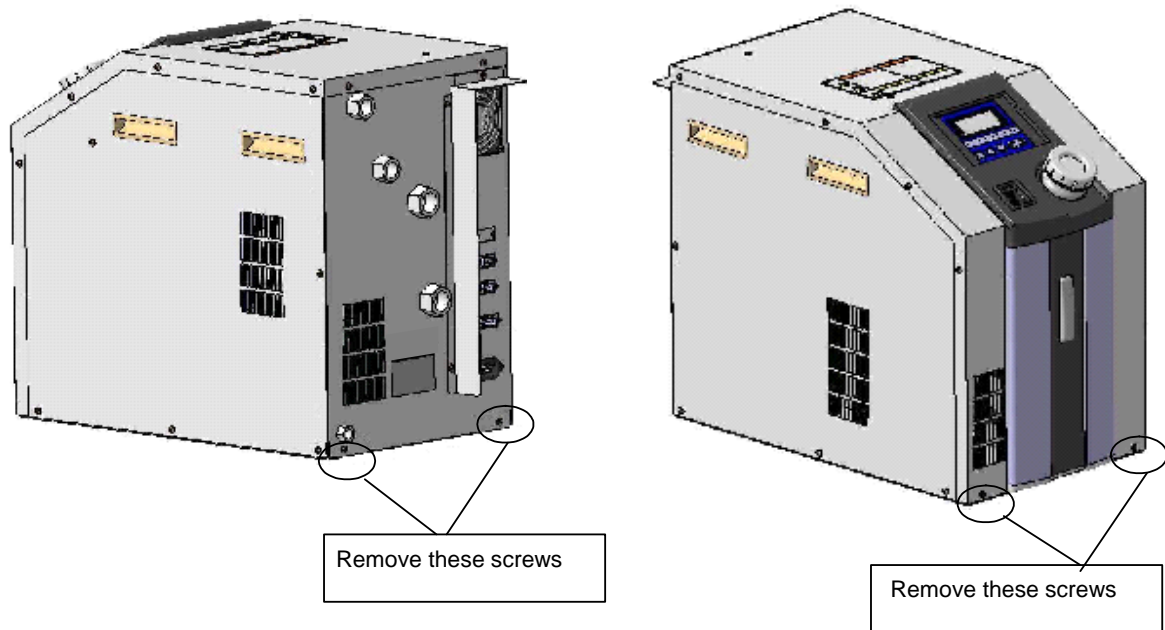

Fig. 3-2 Foot mounting screws

- 2) Then tighten M5 screws (bolts) or equivalent into 4 holes sized to 7mm on the parts marked with arrow for mounting.

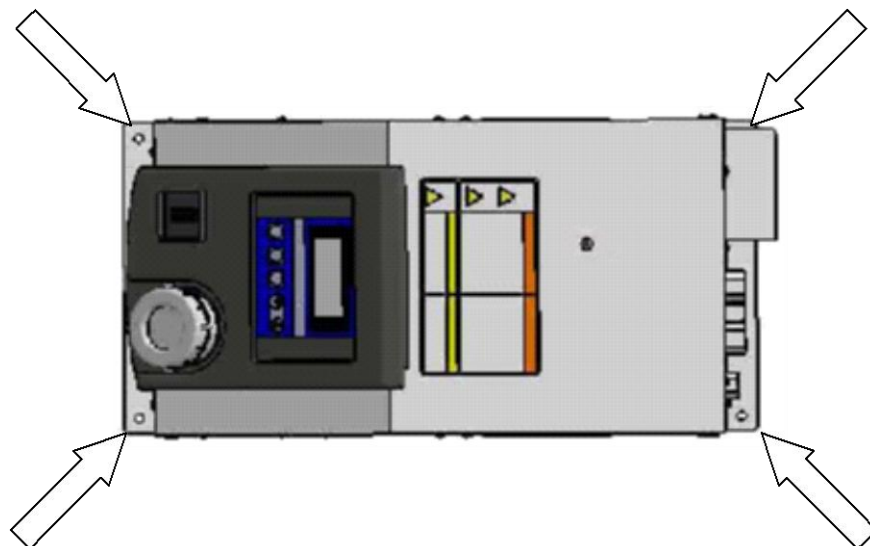

Fig3-3 Mounting

▲ CAUTION
Tighten the screws (bolts) for mounting by given torque.

3.4 Piping

- 1) Increase the flow rate of the recirculating fluid to maintain the temperature stability. Therefore, shorten the distance with heat load, and set it up so that the length of piping may shorten. The tube for piping should be as thicker as possible.
- 2) Reduce the use of elbow fitting or tube bends as this increase the resistance to flow and as such causes a flow reduction.
- 3) Install an open reservoir on the way of piping causes the overflow.
- 4) The built-in tank may cause liquid leakage if the tank is broken by negative pressure generated in the tank led by unbalance pressure in piping due to evaporation of thermostat recirculating fluid.
If there is no need to be used in an air-tight circuit, remove the packing at the lid of the tank to use it as an open tank.

▲ CAUTION

Do not mistake IN for OUT of recirculating fluid radiating water. If a check valve etc. is mounted inside the piping, the mistake might prevent flow and cause an alarm.

3.5 Quality of Radiating Water

▲ CAUTION

Use water satisfies the quality standards shown below for radiating water. If other liquids are used, the product could break and leak fluid, resulting in electrical shock or earth leakage.

Table 3-1 Quality standard for fresh water (tap water)

	Item	Standard value
Quality item	pH (25°C)	6.5 to 8.2
	Electric conductivity (25°C) (μS/cm)	100 to 800
	Chloride ion (mgCl-/L)	200 or less
	Sulphate ion (mgSO ₄ ²⁻ /L)	200 or less
	Acid consumption (pH4.8) (mgCaCO ₃ /L)	100 or less
	Total hardness (mgCaCO ₃ /L)	200 or less
	Calcium hardness (mgCaCO ₃ /L)	150 or less
	Ion silica (mgSiO ₂ /L)	50 or less
	Iron (mgFe/L)	1.0 or less
	Copper (mgCu/L)	0.3 or less
	Sulphide ion (mgS ²⁻ /L)	None detected
	Ammonium ion (mgNH ₄ ⁺ /L)	1.0 or less
	Residual chlorine (mgCl/L)	0.3 or less
	Free carbon (mgCO ₂ /L)	4.0 or less
Filtration (μm)	5 or less	

4 Unit overview

4.1 Method of displaying model

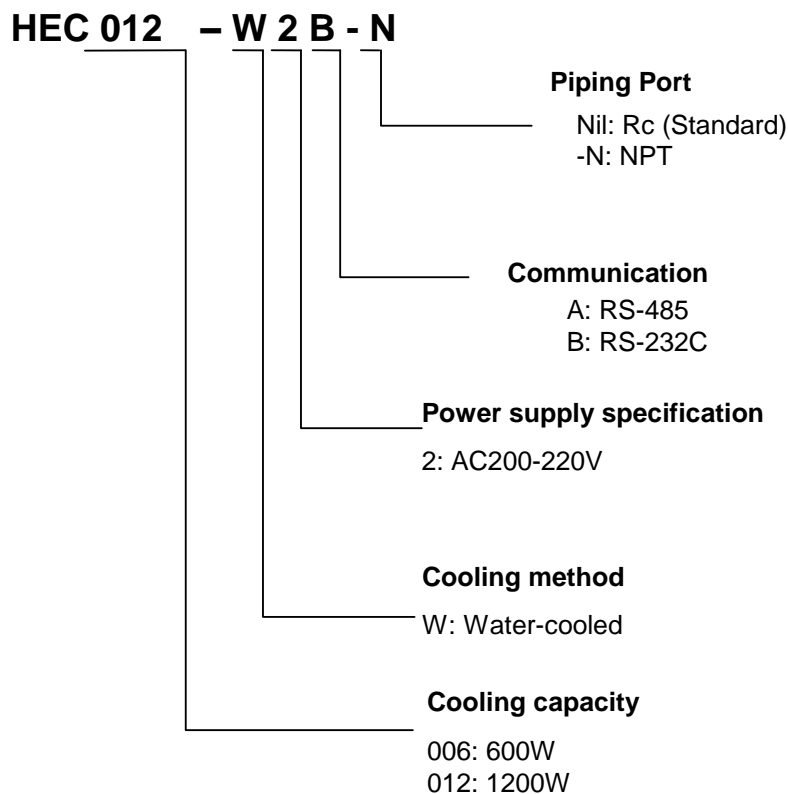

4.2 Manufacturing years method of display

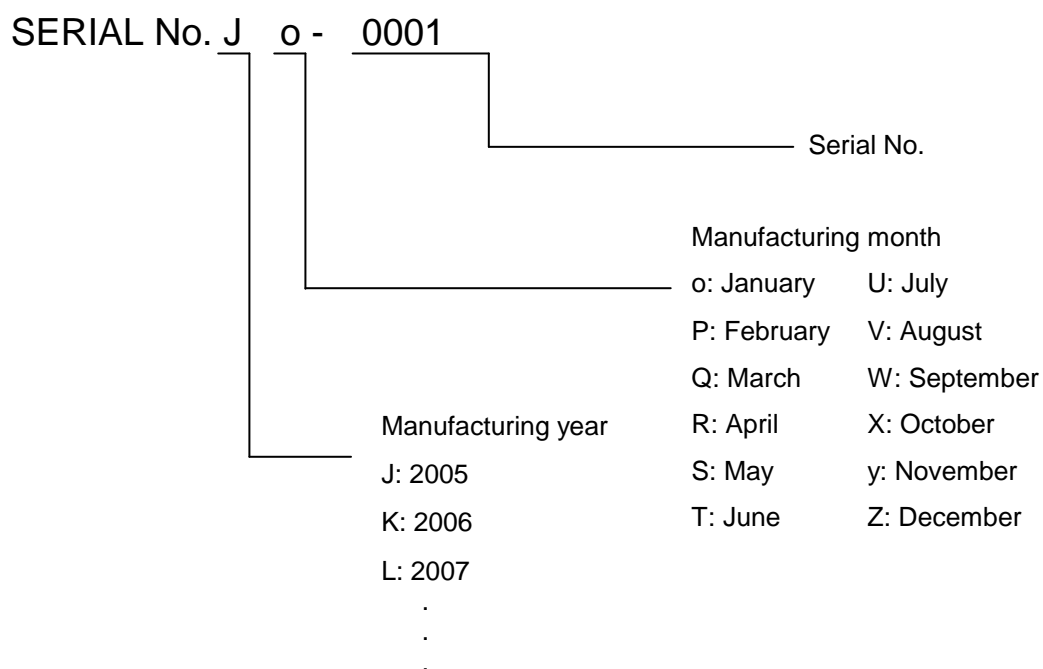

4.3 Model No. label

Model No. label is attached to the unit and indicated as shown below.

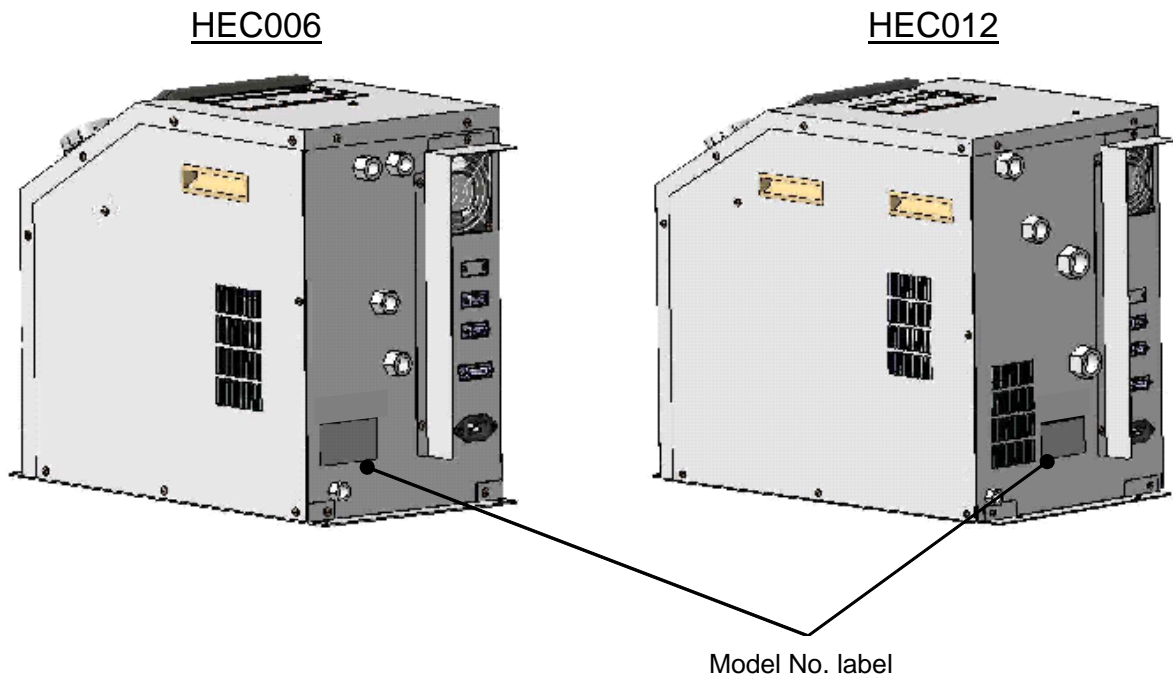

Fig.4-1 Position of Model No. label

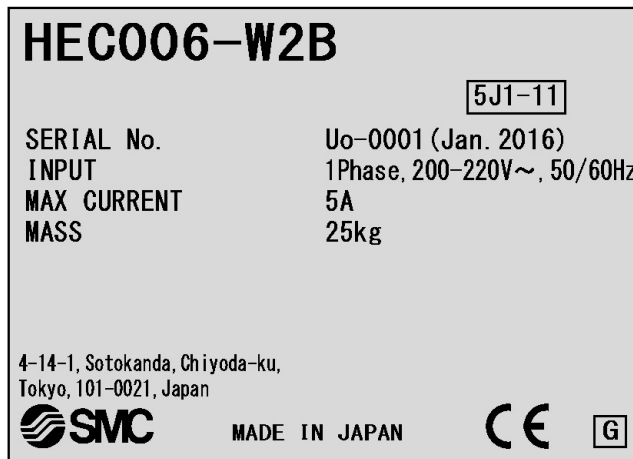
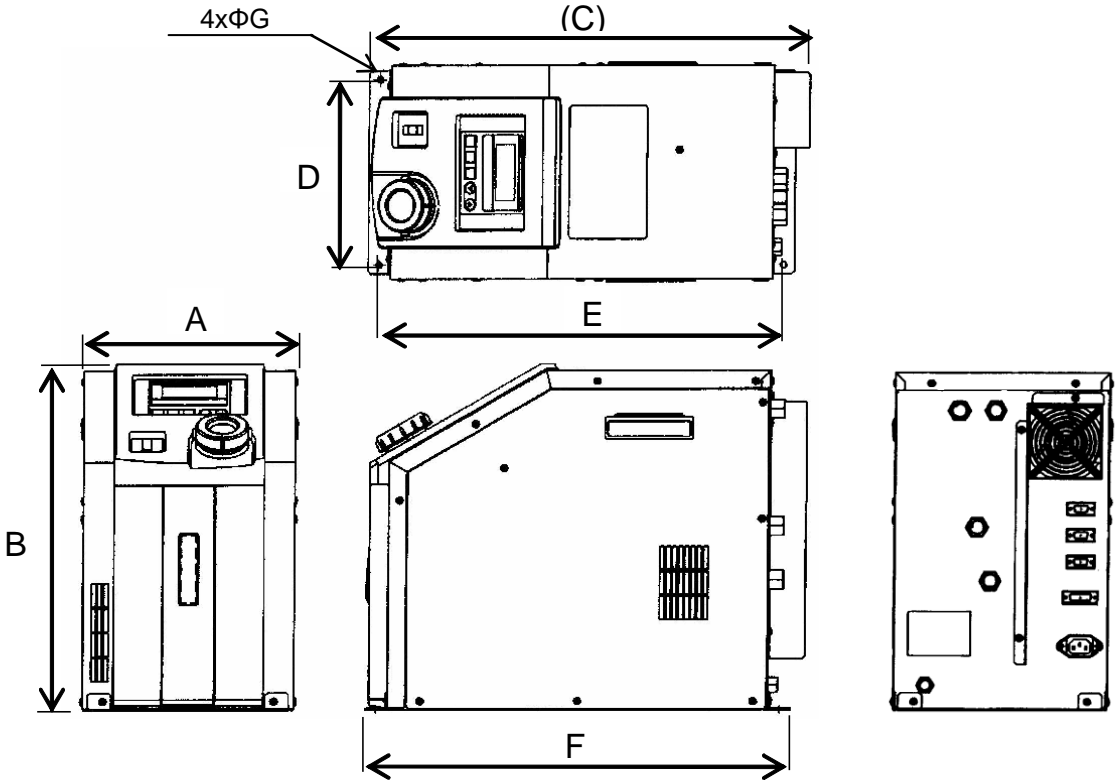

Fig.4-2 Legend of Model No. label

4.4 Appearance

4.4.1 HEC006



	A	B	C	D	E	F	G
HEC006	240	390	497	214	458	482	7

Unit: mm

Fig.4-3 Outside drawings of HEC006

4.4.2 HEC012

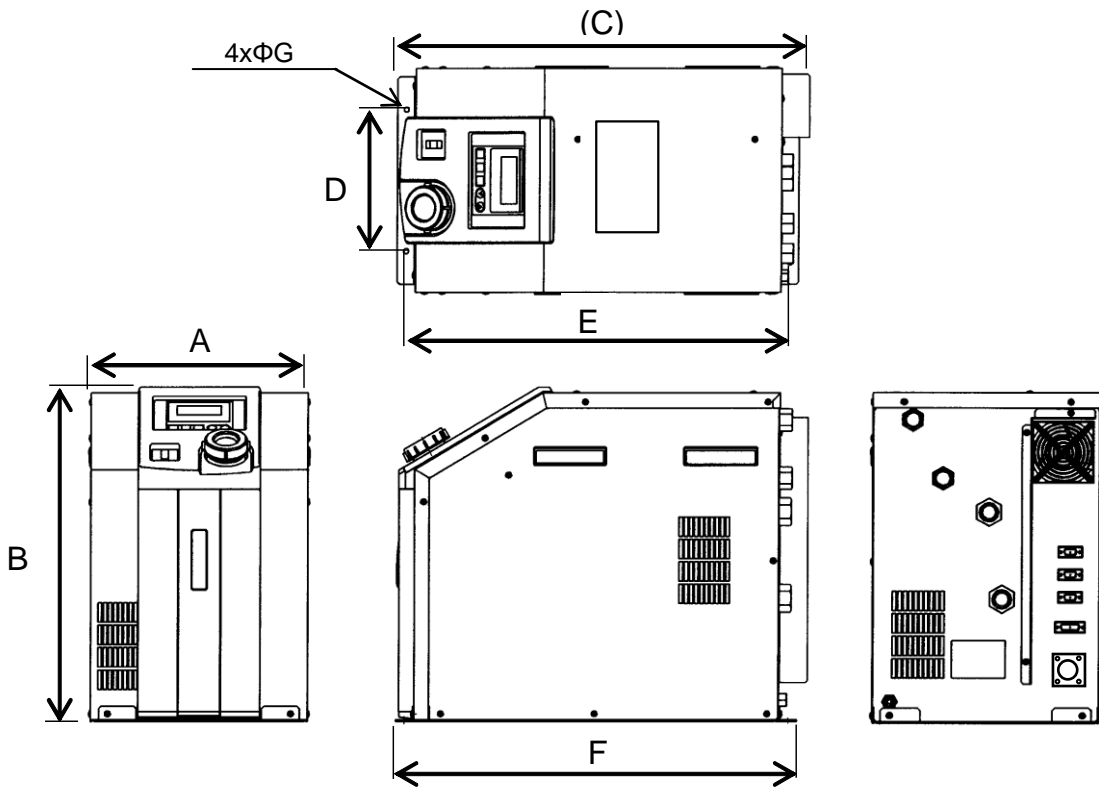

	A	B	C	D	E	F	G
HEC012	300	448	565	190	526	550	7

Unit: mm

Fig.4-4 Outside drawings of HEC012

4.5 Operating Principles

The unit is operated as explained below.

4.5.1 Construction and Principle of Thermo Module

This unit controls the temperature of constant temperature recirculating fluid with a thermo-module (thermoelectric thermal element).

A thermo module (electronic cooling and heating element) is a unit consisting of multiple semiconductor elements. It can perform cooling and heating freely with direct current, be placed in line for electric purposes and be placed in parallel for thermal purposes.

When two different conductors or semiconductors are connected and direct current is applied to them, suction or the generation of heat other than Joule heat is seen at the connected part; this is called the Peltier effect. If P-type and N-type semiconductors are connected with a metal, as shown in the figure below, and current is applied, the suction of heat is seen at the connected part. The other connected part will have a high temperature and will generate heat. This effect is reversible; suction and the generation of heat occurs in the opposite direction when the current direction is reversed. Therefore, if the heat at the-high temperature side is handled efficiently, a continuous heat pumping from low temperature side to low temperature side can be realized. With this principle, the N-type semiconductor has an electron stream flowing in the opposite direction to the current and the P- type semiconductor has a Hall stream flowing in the same direction as the current. These electron and Hall streams move heat.

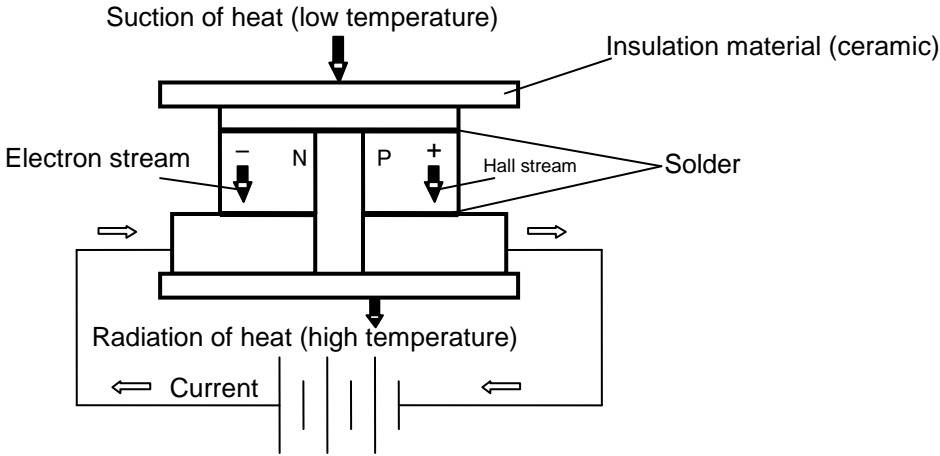

Fig. 4-5 Construction and principle of thermo module

4. 5. 2 Construction of temperature controlling device

A thermo-module is installed in a heat exchanger.

Radiating water flows on one side of the thermo module, and recirculating fluid flows on the other side of the thermo-module.

DC output transmitted from a switching power supply is connected to the thermo module, and a controller controls the DC output from the switching power supply based on the signal sent from the temperature sensor that is mounted on the outlet of the heat exchanger, achieving an accurate control of the constant temperature recirculating fluid.

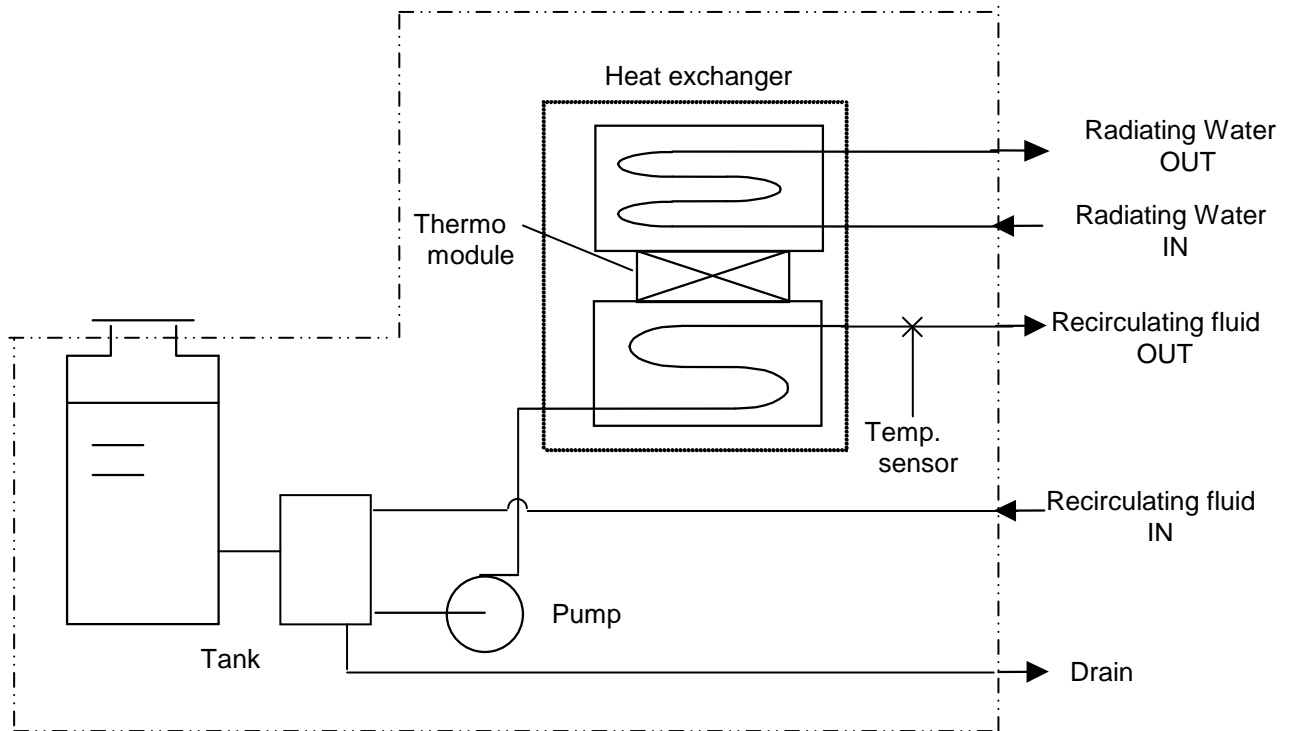

Fig. 4-6 Recirculating fluid and Radiating water circuit

4.5.3 Electrical diagram

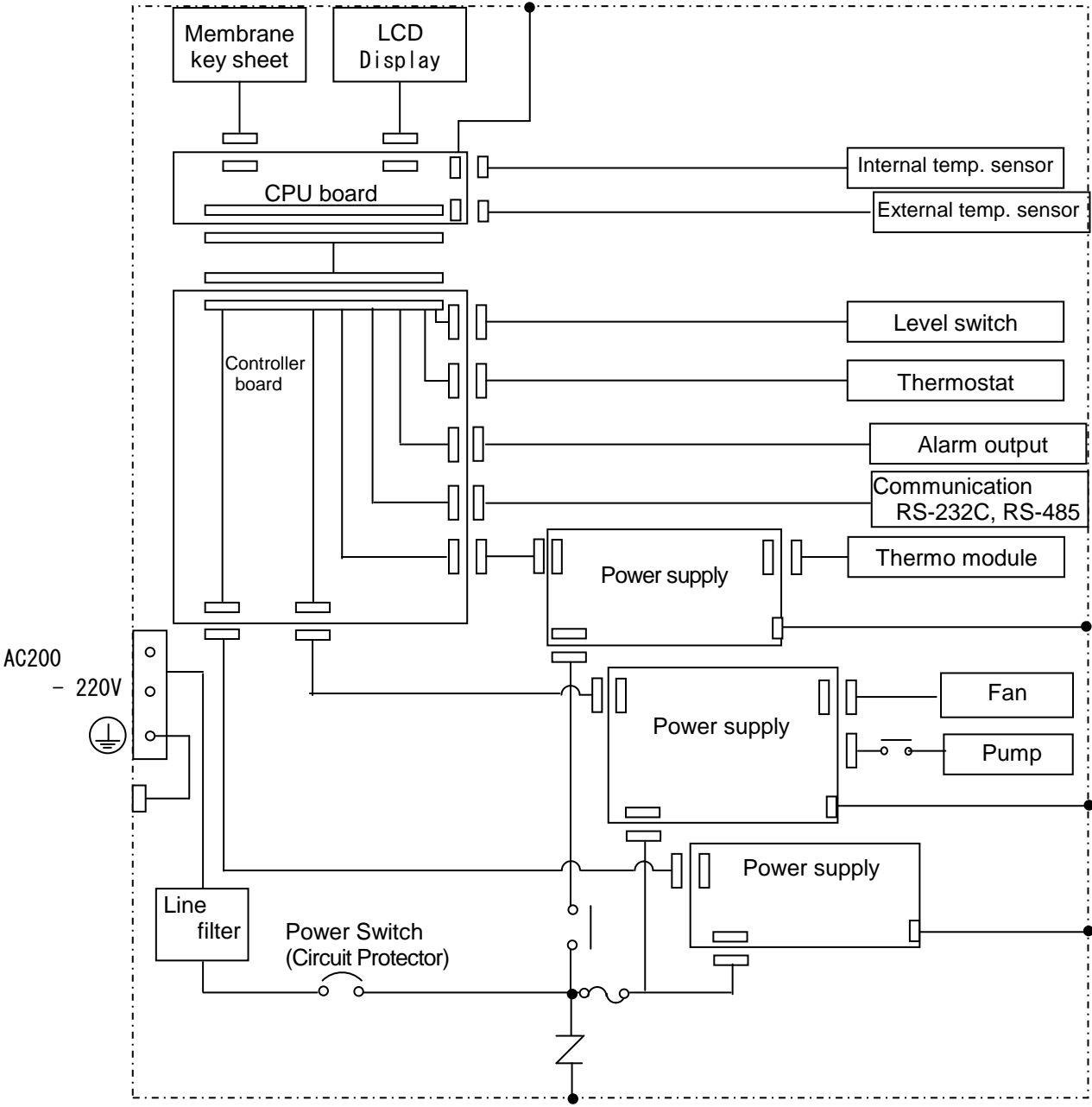

Fig.4-7 Electrical diagram (HEC006)

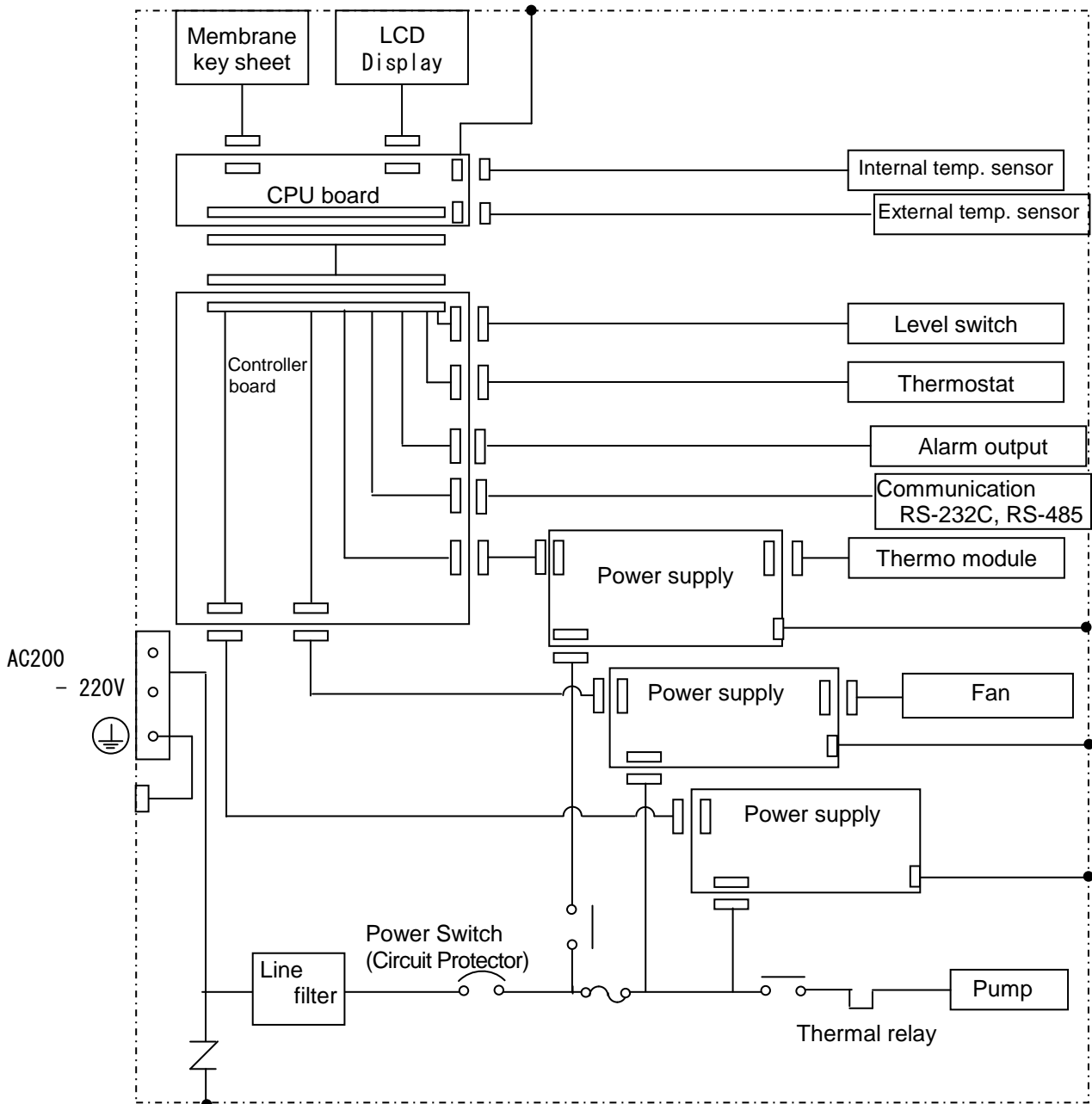

Fig.4-8 Electrical diagram (HEC012)

4.6 Functions

4.6.1 Auto tuning

This is a function to set value necessary for control such as PID (proportional band, integral time, derivative time and ratio of cooling/ heating gain) automatically.

4.6.2 Offset function

This is a function to control temperature sliding it by offset value from set point temperature. The range of offset is -9.99 to 9.99 °C. When the recirculating fluid is carried to a target object, certain deviation is made between temperature before the object and setting temperature of Thermo-con due to influence by ambient temperature of piping inside. At that case, if deviation is input as offset value, temperature of recirculating fluid just before the object can conform with setting value.

Internal sensor value for alarm does not include the offset value.

4.6.3 Learning control function

This is a function to let Thermo-con sample the temperature of recirculating fluid flowing before temperature controlled object by dedicated temperature sensor (external sensor) and make the temperature off-set automatically to its set value with a sampling interval. The dedicated temperature sensor needs to be prepared separately by the customer.

4.6.4 External tune control function

This is a function to make the temperature of recirculating fluid consistent to the external (ambient) temperature all the time. This function is to let Thermo-con sample the temperature wherever preferred a temperature sensor is mounted and make the temperature of the fluid consistent automatically with the temperature detected by the sensor. The dedicated temperature sensor needs to be prepared separately by the customer.

4.6.5 Temperature sensor fine control function

This is a function to finely control measurement temperature of control sensor within the range of -9.99 to 9.99 °C apart from offset function. Control sensor can be corrected by inputting difference (calibration value) between temperature of standard and that of control sensor.

Internal sensor value for alarm includes the fine control value.

Internal sensor value for alarm = Internal sensor value – Fine control value

4.6.6 Setting value memory function (Function that backs up with EEPROM)

This is a function that all setting value manually input is backed up with nonvolatile memory, EEPROM. Even if power is turned off, the setting condition just before turning off power is reproduced at re-start. Resetting is not necessary.

4.6.7 Upper/ Lower Temperature Limit Alarm Function

This is a function that alarm operates when control temperature is out of allowable upper range and allowable lower range. When alarm operates, WRN is indicated on LCD. If control temperature returns to within allowable upper/ lower range, this alarm is automatically canceled. Allowable upper/ lower range of temperature can be set at the range of 0.1 to 10 °C independently.

4.7 Auto tuning function

Although a PID factor is set at the time of shipment, if controlled temp. fluctuates constantly, perform auto tuning. Controller calculates optimum control PID and set automatically. Although it depends on the operation conditions, it may take time until the auto tuning will be completed.

- 1) Select "2" in control operation choices
- 2) Pressing [AT] key to light "AT" indicator and start auto tuning.
- 3) Pressing [AT] key stops auto tuning. ("AT" indicator turns off)
- 4) "AT" indicator turns off when auto tuning completes. If not completed after 20min. [ERR19] (AT abnormal) occurs.
- 5) If auto tuning is no successful, reset to default value (refer table 8-2), or input the optimum value.

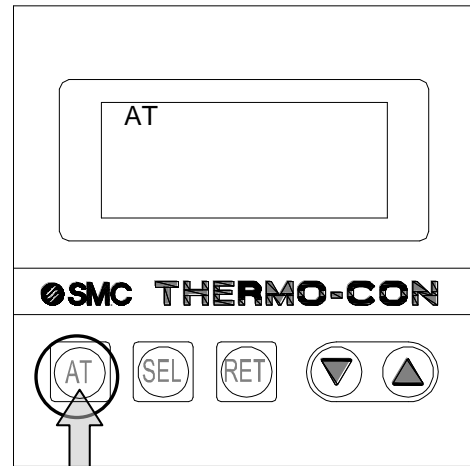
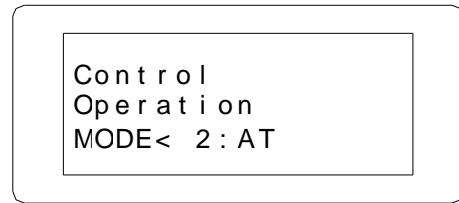

5 Names and Functions of Components

5.1 HEC006

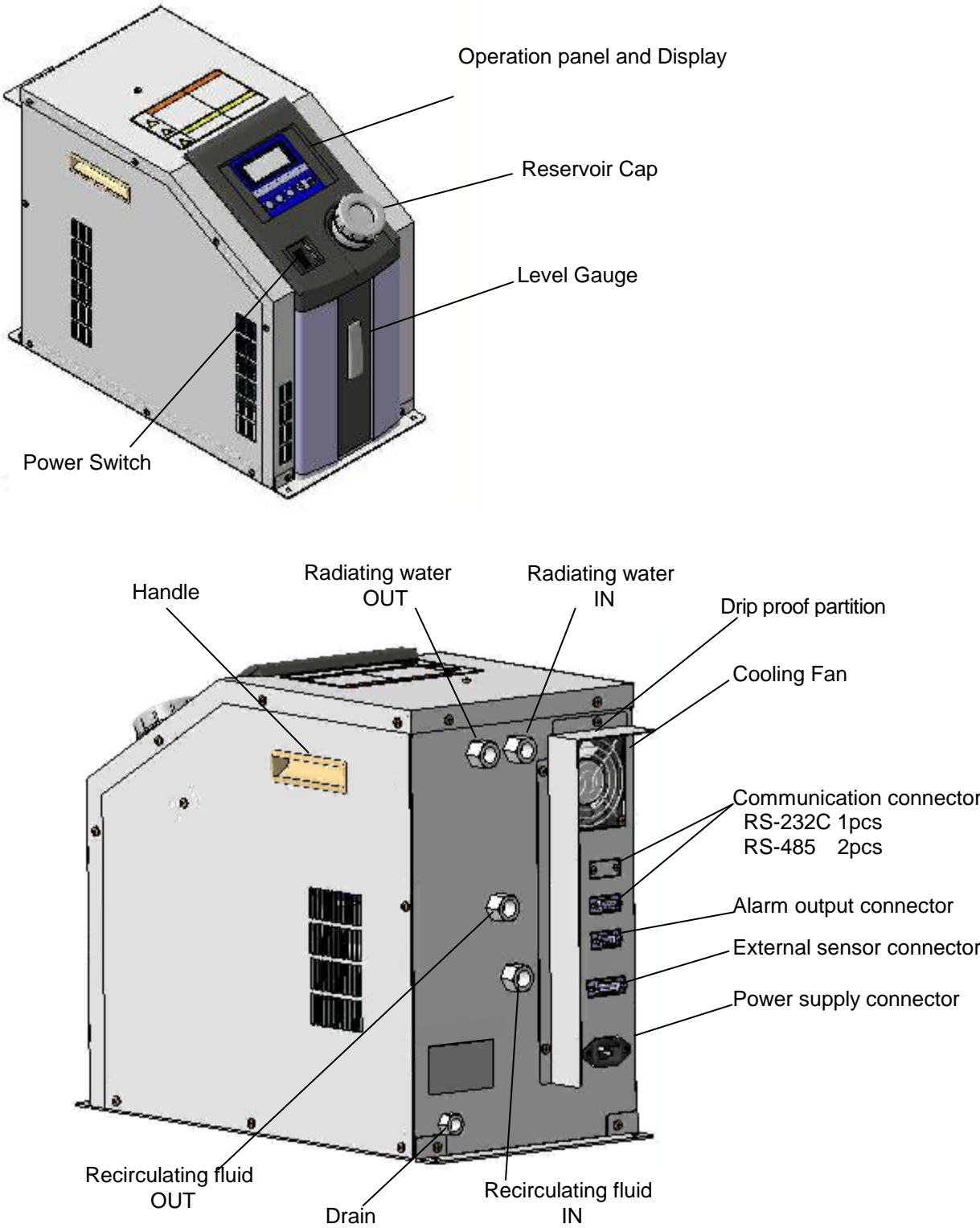

Fig.5-1 Components of HEC006

5.2 HEC012

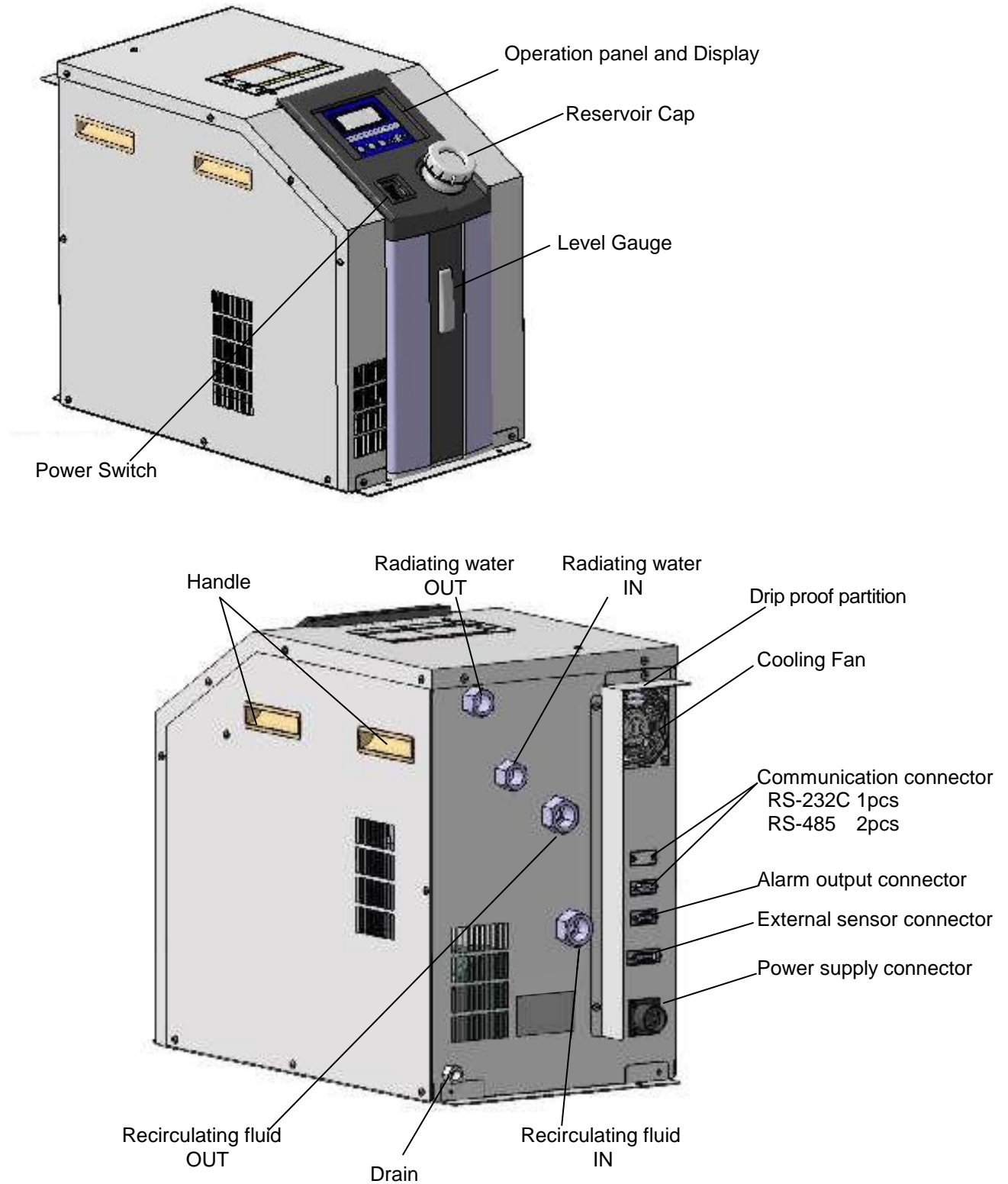

Fig. 5-2 Components of HEC012

Table 5-1 Function of Components

Description	Function
Operation panel and display	Various displays are shown and settings are input.
Power Switch (circuit protector)	Turns the power supply of the product on and off.
Level gauge	It displays liquid level of the installed tank.
Reservoir cap	This is a screwed type cap. Remove it when supplying the fluid
Radiating water IN	Radiating water inlet port. Port Size HEC006----Rc3/8 HEC012----Rc1/2
Radiating water OUT	Radiating water outlet port. It is the same size as the inlet port.
Recirculating fluid IN	Recirculating fluid inlet port. Port Size HEC006----Rc3/8 HEC012----Rc3/4
Recirculating fluid OUT	Recirculating fluid outlet port. It is the same size as the inlet port.
Drain	This is an exhaust port of the tank, with Rc1/4 of port size.
Cooling fan	Fan for cooling the internal electric components of the controller. Air is sucked in from the controller side and discharged through the back via this fan.
Power supply connector (AC)	Connector for the single phase AC (AC200 to 220V) power supply. A power supply cable is connected here.
External sensor connector (EXT.SENSOR)	To use learning control function, external sensor is connected.
Alarm output connector (ALARM)	Connector for the upper/lower temperature limit alarm and output cut-off alarm. A relay contact is open or close when these alarms are output.
Communication connector (RS-232C) or (RS-485)	Connector for communication with RS-485 or RS-232C. There are two connectors in RS-485 and one connector in RS-232C.
Drip proof partition	This is a cover to prevent the radiating water and recirculating fluid leaking from the connected part of the fitting from splashing over the connector and fan. It can be removed.

5.3 Operation panel

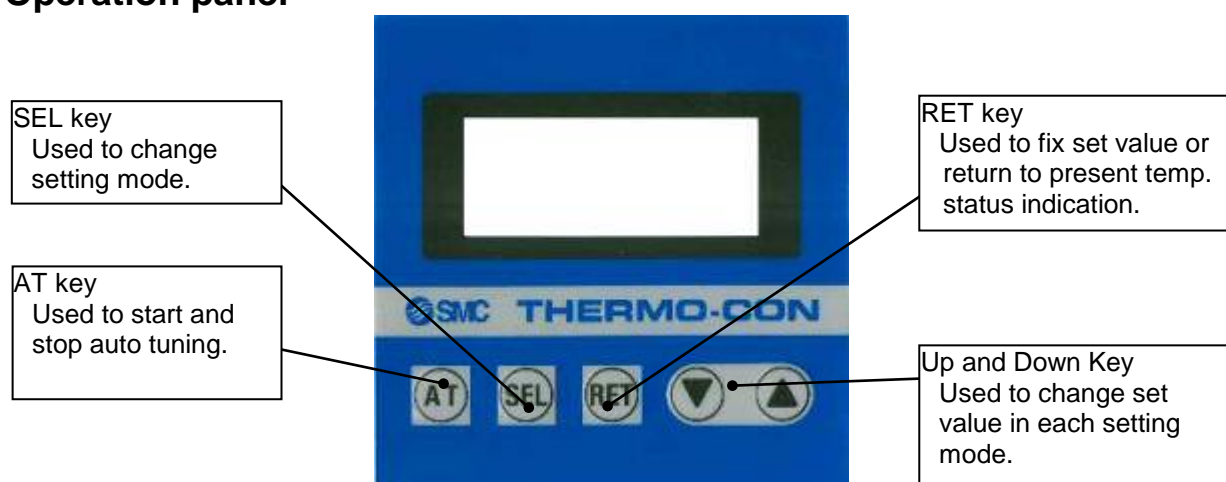

Fig.5-3 Operation panel

5. 4 Display

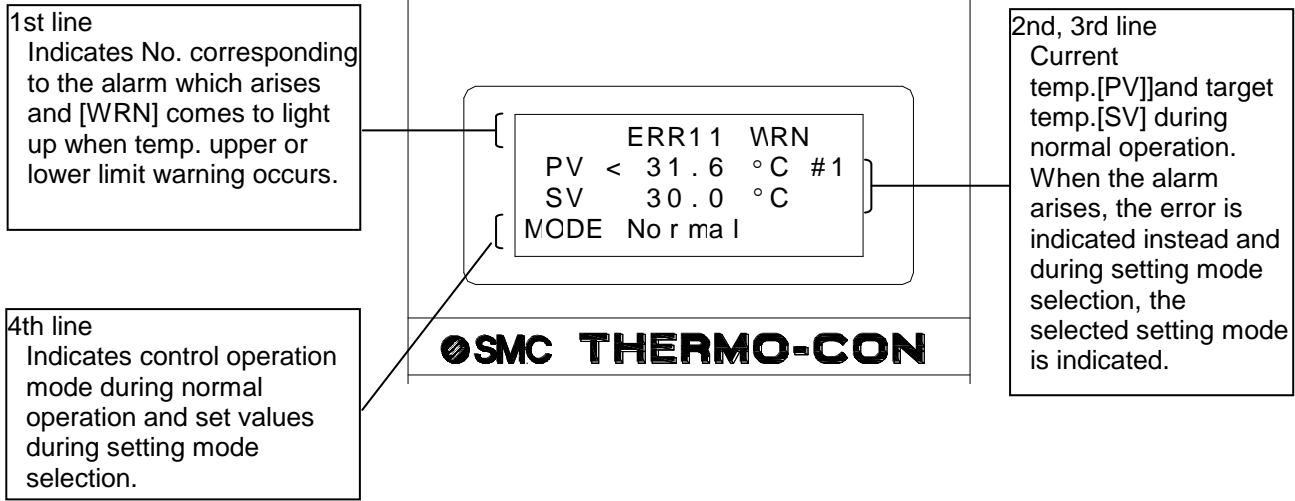

Fig.5-4Display

5. 5 Reservoir Cap

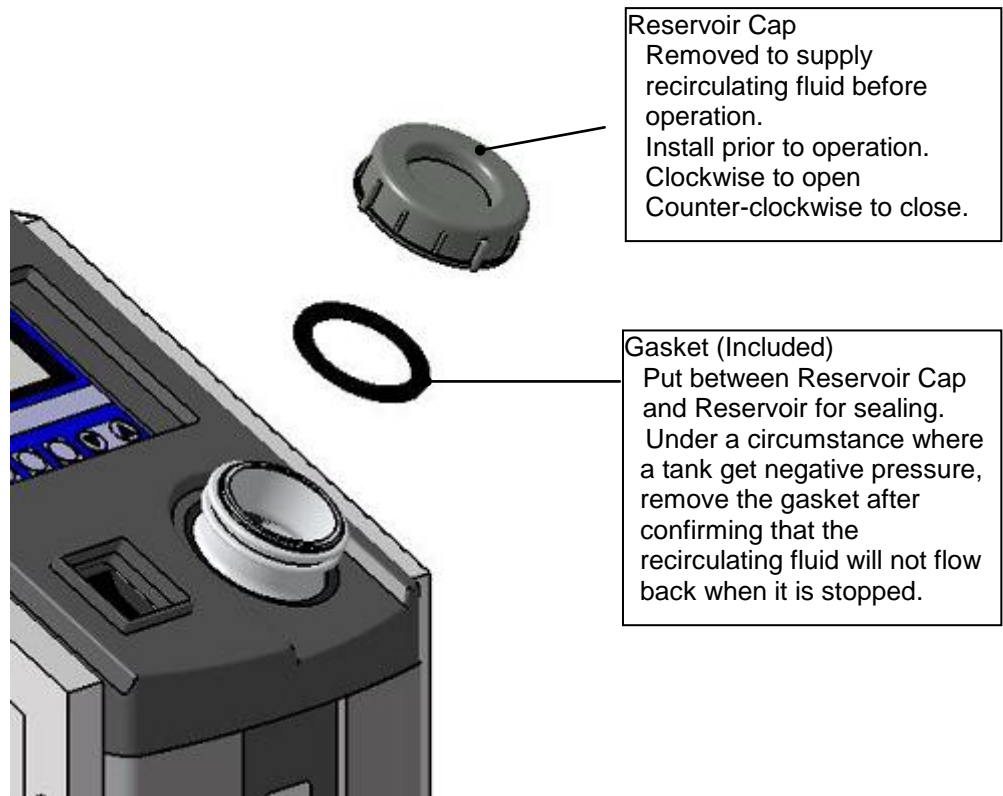

Fig.5-5 Reservoir Cap

6 Specifications

6.1 Specification table

Table6-1 Specifications of HEC006

Item	Spec.	
Model	HEC006-W2A	HEC006-W2B
Communication	RS-485	RS-232C
Operation temp. range	10.0 to 60.0 °C (No dew condensation)	
Indication temp. range	-9.9 to 80.0 °C	
Ambient environment	Temp. :10 to 35 °C Humidity : 35 to 80%RH Environment : No corrosive gas, solvent such as thinner and flammable gas	
Storage environment	Temp. :-40 to 70 °C (No dew condensation and avoid freezing inside by draining water completely) Humidity : 5 to 95%RH Environment : No corrosive gas, solvent such as thinner and flammable gas	
Accuracy related to temp.	Indication accuracy: +/- 0.2 °C. Stability: +/- 0.01 to 0.03 °C (recirculating fluid OUT is directly connected with IN) (It differs depending on ambient conditions.)	
Cooling capacity	Approx.600W(water), 400W(Fluorinert FC-77) Conditions: set temp. 25°C, ambient temp. 25°C, radiating water temp. 20°C, radiating water flow rate 8 L/min	
Heating capacity	Approx.900W(water), 600W(Fluorinert FC-77) Conditions: set temp. 25°C, ambient temp. 25°C, radiating water temp. 20°C, radiating water flow rate 8 L/min	
Recirculating fluid	Recirculating fluid : Water, Fluorine solvent(GALDEN HT-135 Fluorinert FC-77, FC-3283) Reservoir capacity : Approx.3L Pump: Max. pressure (shut off pressure) : 0.09MPa(Water), 0.14MPa(FC-77)	
Radiating water (Note)	Flow rate: 8 to 15L/min Temperature: 10 to 35 °C (No dew condensation) Max. operating pressure: 1MPa	
Piping port size	Recirculating fluid IN/OUT : 3/8 Radiating water IN/OUT : 3/8 Recirculating fluid drain : 1/4 (with a plug)	
Wetted materials	Radiating water side:SUS303, SUS304 Recirculating fluid side: SUS303, SUS304, EPDM, Ceramic, PPS glass 30%, Carbon, Polyethylene, Polyurethane	
Power supply voltage	Single phase AC200 to 220V, 50/60Hz	
Current consumption	MAX 5A	
Max. sound pressure	62 dB	
Inrush current	50A or less	
Over current protection	10A circuit protector	
Insulation resistance	50MΩ or more (DC500V, with surge absorber removed)	
Main functions	Auto tuning, Off set, Temperature sensor fine control, Temp. upper and lower limit alarm, Output shut off alarm, Serial communication	
Input operation and indications	Membrane key sheet LCD display panel (with back light)	
Temp. sensor	Resistance thermometer sensor (Pt100Ω, 3-wire, class A, 2mA) (both internal sensor and external sensor)	
Painting color	Urban white	
Mass (at dry)	Approx.25kg (with feet)	

Note) If radiating water is poured excluding the range of the specification, the noise and the vibration are generated. Moreover, radiating water might become a high temperature.

Table6-2 Specifications of HEC012

Item	Spec.	
Model	HEC012-W2A	HEC012-W2B
Communication	RS-485	RS-232C
Operation temp. range	10.0 to 60.0 °C (No dew condensation)	
Indication temp. range	-9.9 to 80.0 °C	
Ambient environment	Temp. :10 to 35 °C Humidity : 35 to 80%RH Environment : No corrosive gas, solvent such as thinner and flammable gas	
Storage environment	Temp. :-40 to 70 °C (No dew condensation and avoid freezing inside by draining water completely) Humidity : 5 to 95%RH Environment : No corrosive gas, solvent such as thinner and flammable gas	
Accuracy related to temp.	Indication accuracy: +/- 0.2 °C. Stability: +/- 0.01 to 0.03 °C (recirculating fluid OUT is directly connected with IN) (It differs depending on ambient conditions.)	
Cooling capacity	Approx.1200W(water), 800W(Fluorinert FC-77) Conditions: set temp. 25°C, ambient temp. 25°C, radiating water temp. 20°C, radiating water flow rate 10 L/min	
Heating capacity	Approx.2200W(water), 1500W(Fluorinert FC-77) Conditions: set temp. 25°C, ambient temp. 25°C, radiating water temp. 20°C, radiating water flow rate 10 L/min	
Recirculating fluid	Recirculating fluid : Water, Fluorine solvent(GALDEN HT-135 Fluorinert FC-77, FC-3283) Reservoir capacity : Approx.5L Pump: Max. pressure (shut off pressure) : 0.16MPa(Water 60Hz), 0.28MPa(FC-77 60Hz)	
Radiating water (Note)	Flow rate: 10 to 15L/min Temperature: 10 to 35 °C (No dew condensation) Max. operating pressure: 1MPa	
Piping port size	Recirculating fluid IN/OUT : 3/4 Radiating water IN/OUT : 1/2 Recirculating fluid drain : 1/4 (with a plug)	
Wetted materials	Radiating water side:SUS303, SUS304 Recirculating fluid side: SUS303, SUS304, EPDM, Ceramic, PPS glass 30%, SiC, Polyethylene, Polyurethane	
Power supply voltage	Single phase AC200 to 220V, 50/60Hz	
Current consumption	MAX 10A	
Max. sound pressure	64dB	
Inrush current	50A or less	
Over current protection	15A circuit protector	
Insulation resistance	50MΩ or more (DC500V, with surge absorber removed)	
Main functions	Auto tuning, Off set, Temperature sensor fine control, Temp. upper and lower limit alarm, Output shut off alarm, Serial communication	
Input operation and indications	Membrane key sheet LCD display panel (with back light)	
Temp. sensor	Resistance thermometer sensor (Pt100Ω, 3-wire, class A, 2mA) (both internal sensor and external sensor)	
Painting color	Urban white	
Mass (at dry)	Approx.40kg (with feet)	

Note) If radiating water is poured excluding the range of the specification, the noise and the vibration are generated. Moreover, radiating water might become a high temperature.

6.2 Performance chart

Value on performance chart is not guaranteed value but representative value. The value used for consideration should not be the very limit for the safety.

6.2.1 Performance of HEC006

1) Cooling capacity

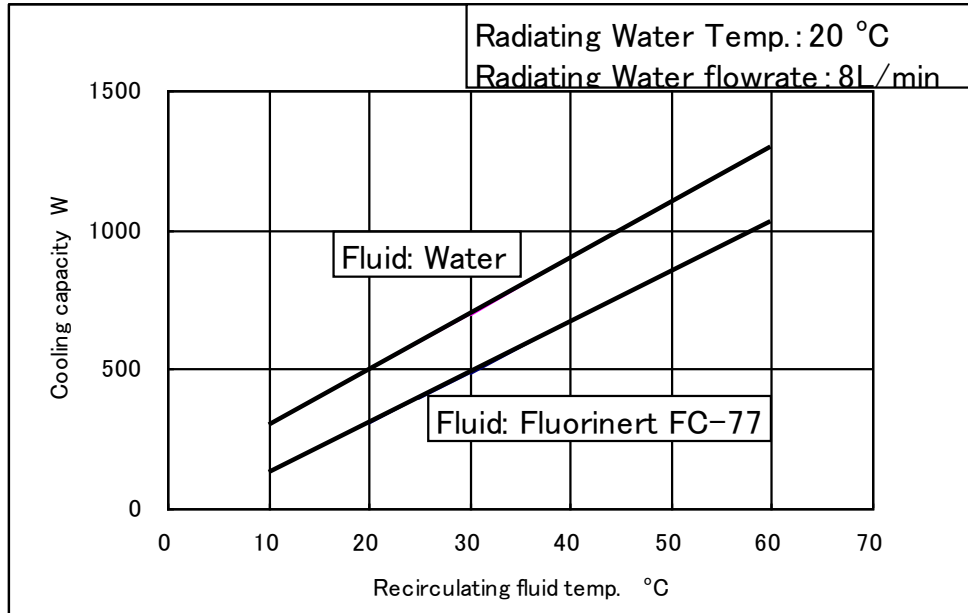

Fig. 6-1 Cooling capacity of HEC006

2) Heating capacity

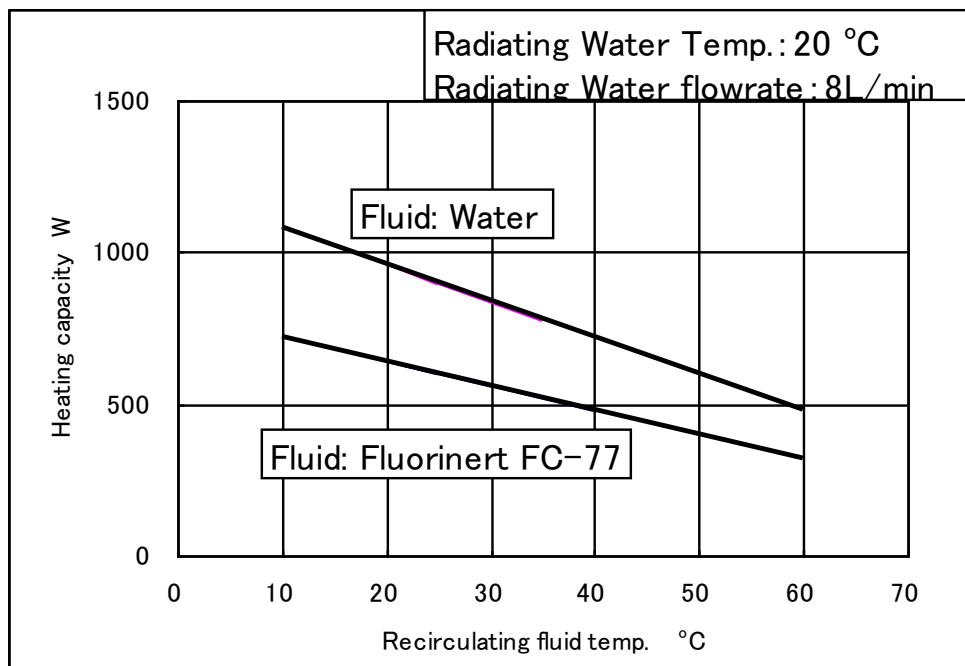

Fig. 6-2 Heating capacity of HEC006

3) Pump capacity

The pressure on Y axis stands for discharge pressure of recirculating fluid from Thermo-con.

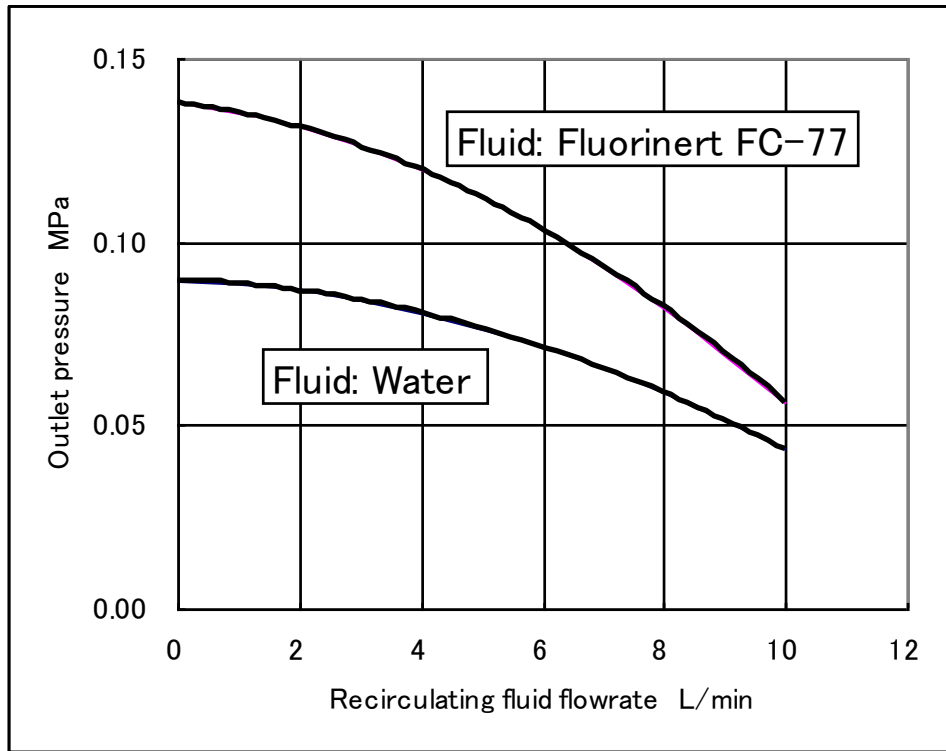

Fig. 6-3 Pump capacity of HEC006

4) Pressure loss of radiating water

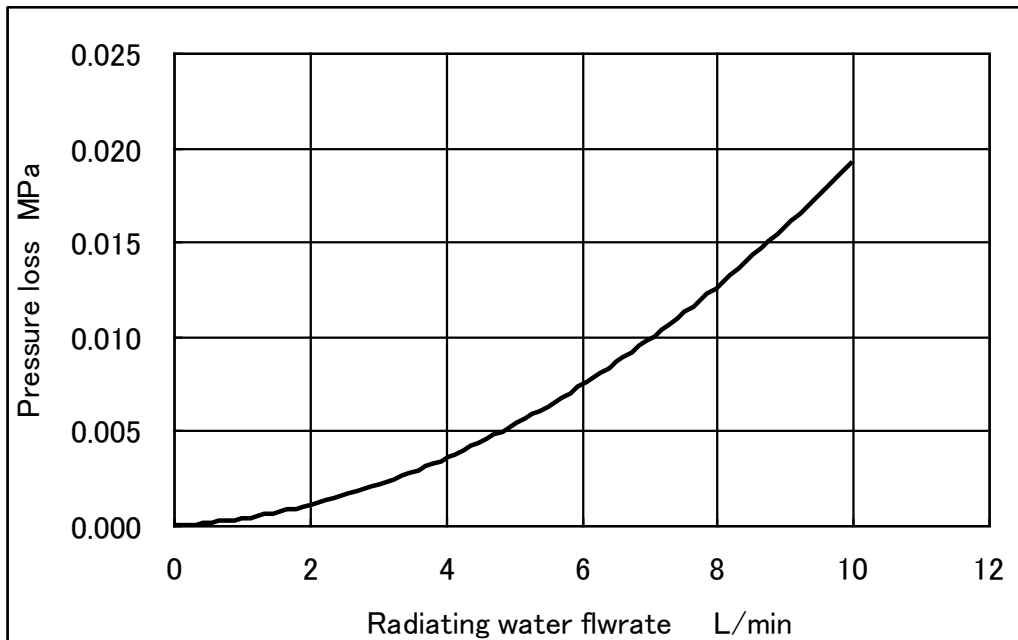

Fig. 6-4 Pressure loss of HEC006

6.2.2 Performance of HEC012

1) Cooling capacity

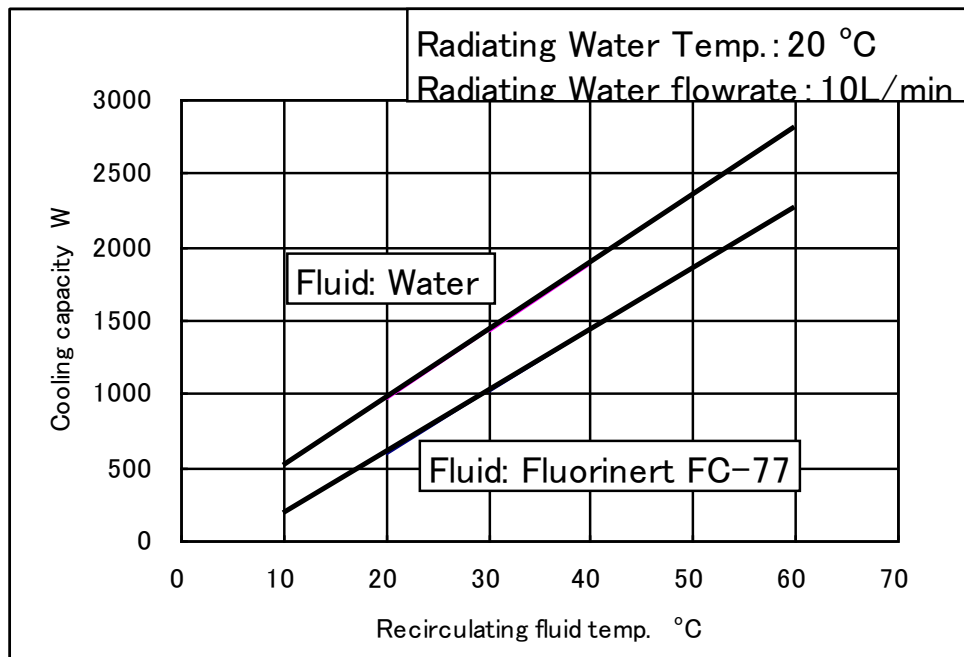

Fig. 6-5 Cooling capacity of HEC012

2) Heating capacity

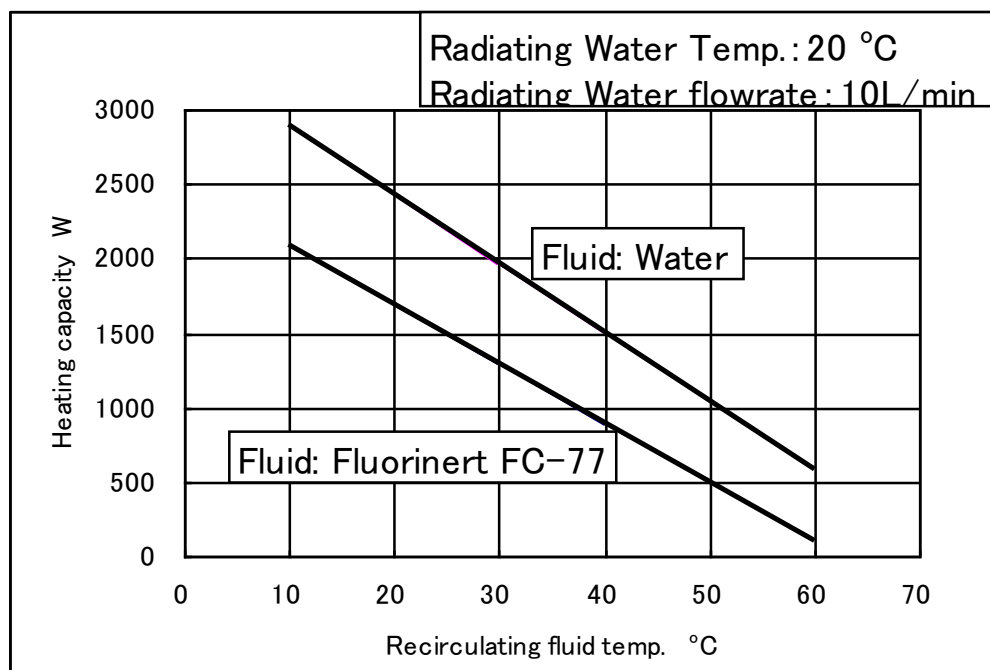

Fig. 6-6 Heating capacity of HEC012

3) Pump capacity

The pressure on Y axis stands for discharge pressure of recirculating fluid from Thermo-con.

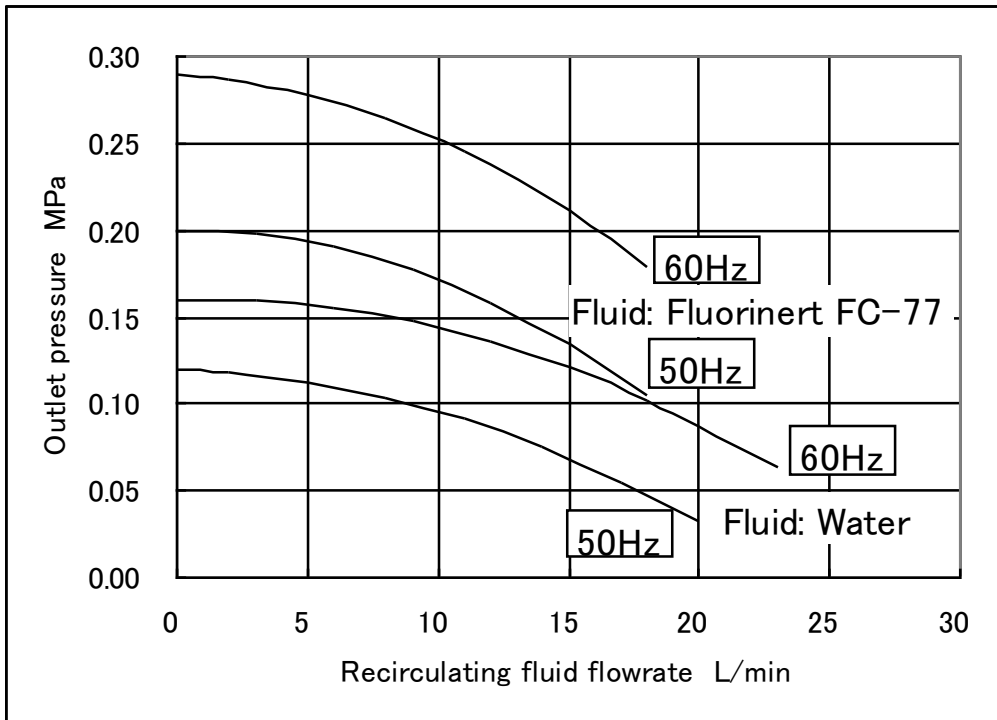

Fig. 6-7 Pump capacity of HEC012

4) Pressure loss of radiating water

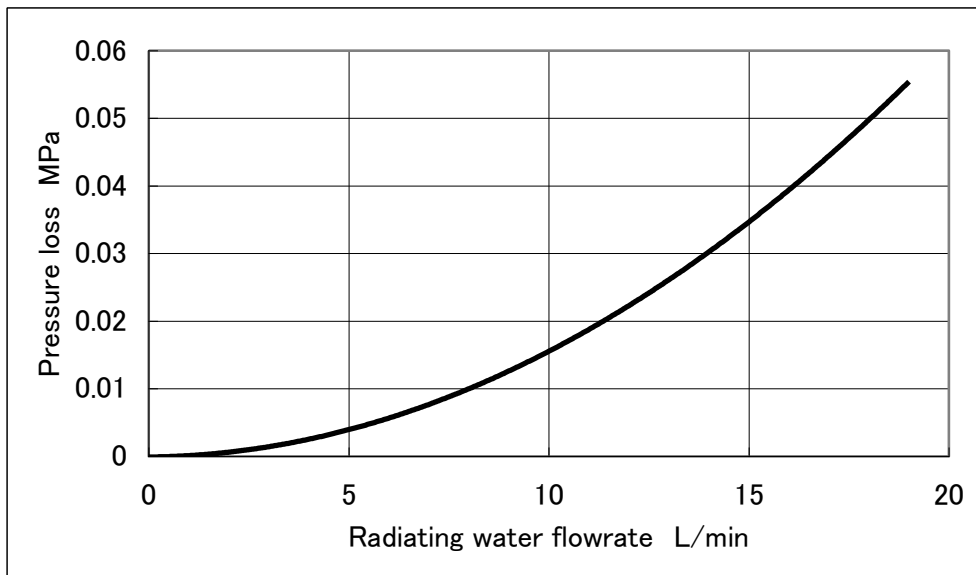

Fig. 6-8 Pressure loss of HEC012

7 Preparation for Operation

7.1 Piping

7.1.1 Preparation for radiating water

The piping for radiating water is connected as below.

- 1) Connect fittings to the ports marked [Radiating water IN] and [Radiating water OUT] at the rear side of the equipment. (the same fittings are used for IN and OUT)

Port size HEC006---3/8
 HEC012---1/2

- 2) When connecting a fitting to the port, hold the mounting part of the fitting with a wrench to protect the fitting mounting part of the product from directly receiving the force created by the mounting work.

Tightening torque: HEC006--- 22 to 24Nm
 HEC012---28 to 30 Nm

- 3) Apply the following amount of cooling water.

HEC006— 8 to 15L/min
 And HEC012— 10 to 15L/min

When the flow rate of the radiating water is not enough, cooling capacity will decline. Meanwhile, when the flow rate is extremely small, alarm (Err14) may occur and the temperature of the radiating water might be extremely high. If a resin tubing is used for piping under these circumstances, the tubing might get softened and exploded. Therefore, be sure to cool the radiating water over time and flow the radiating water with a proper flow rate.

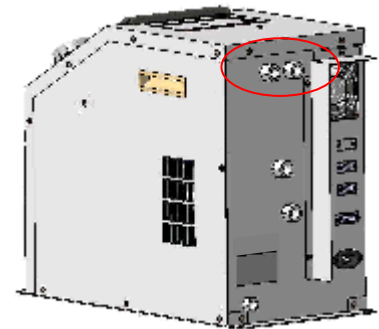

HEC006

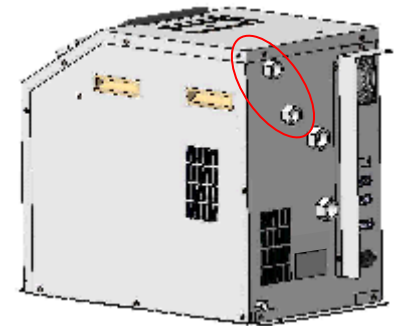

HEC012

▲ CAUTION

Use fresh water such as tap water for the radiating water. If radiating water is circulated, control the quality of the radiating water to prevent corrosion of the wetted material. For quality standards for the radiating water, refer to “3.5 Quality of Radiating Water.

▲ CAUTION

**Keep the radiating water temperature between 10 and 35°C. (No dew condensation)
 Note that the cooling and heating capacity is changed depending on radiating water temperature. Also, if lower-temperature radiating water is supplied, dew may condense in the product and the equipment could be damaged. Keep the temperature above the atmospheric pressure dew point. To obtain the dew point, refer to “10.3 Calculation of Dew Point Temperature (from a psychrometric chart).**

▲ CAUTION

The maximum operating pressure is 1.0MPa. Keep the pressure as low as possible to prevent water hammer.

7. 1. 2 Preparation for recirculating fluid

The piping for recirculating fluid is connected as below.

- 1) Connect fittings to the ports marked [Recirculating fluid IN] and [Recirculating fluid OUT] and [Drain] at the rear side of the equipment. (the same fittings are used for IN and OUT)

Port size HEC006---3/8
 HEC012---3/4
 Drain---1/4

- 2) When connecting a fitting to the port, hold the mounting part of the fitting with a wrench to protect the fitting mounting part of the product from directly receiving the force created by the mounting work.

Tightening torque: HEC006--- 22 to 24 Nm
 HEC012--- 28 to 30 Nm
 Drain ---12 to 14 Nm

- 3) A plug is mounted on DRAIN for recirculating fluid. When the piping for drain is connected, remove this plug beforehand.
 Be sure to arrange the piping on the drain to exhaust the constant temperature recirculating fluid in the unit at the maintenance.

Width across flat of plug: 6mm

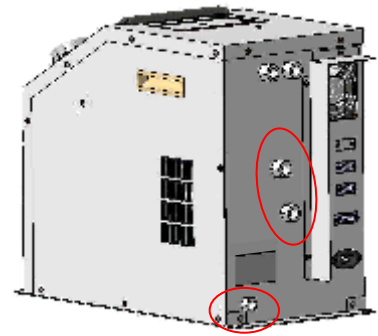

HEC006

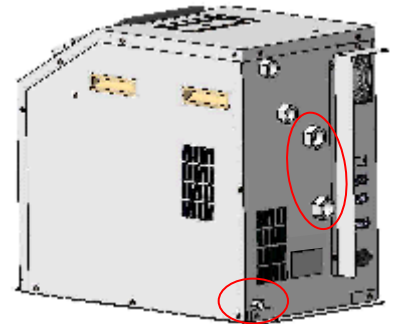

HEC012

⚠ CAUTION

Fluid other than water and Fluorine solvent (GALDEN HT-135, Fluorinert FC-77) is not to be used as recirculating fluid. Using such a fluid (high specific gravity or high viscosity) might lead to fluid leakage and damage of the pump.

⚠ CAUTION

If a tank released to atmosphere is mounted outside, minimize the piping resistance at RETURN of recirculating fluid. If the piping resistance is high, causing the built-in reservoir of Thermo-con can have negative pressure resulting in deformation and crack. The built-in reservoir of Thermo-con is made of plastic and must not be subject to negative pressure larger than -0.02MPa.

⚠ CAUTION

Once the plug is removed from the drain port, the leakage from it is not guaranteed. Therefore, seal it with PTFE seal tape etc. and ensure there is no leakage from it before operation.

⚠ CAUTION

When fluorinated fluid is used as recirculating fluid, static electricity occurred by the flow friction may damage or malfunction the unit. To eliminate the static electricity, use metal for the piping material, while taking measures including grounding earth if necessary.

7.2 Wiring

7.2.1 Power supply

The power supply shall be connected with attached power supply cable. Confirm the power supply at factory has enough capacity and the voltage is within specified value beforehand (with reference to electrical specifications of the power supply). This unit is provided with the power supply cable. The power supply cable shall be connected properly in accordance with Chapter 10 "Power Supply Cable".

Electric specifications of the power supply

HEC006 AC200-220V, 50/60Hz 5A Single phase 2-wire type + GND (PE) line
--

HEC012 AC200-220V, 50/60Hz 10A Single phase 2-wire type + GND (PE) line

▲ CAUTION

Do not bend, pull or bind the power supply cable with a strong force. It may damage the power supply cord or potentially cause electric shock or fire..

7.2.2 Circuit Breaker

The model HEC006 Thermo-Con must be installed downstream of a Circuit Breaker (UL 489 Listed and IEC 60947-2 Approved) rated 10A or less. The model HEC012 Thermo-Con must be installed downstream of a Circuit Breaker (UL 489 Listed and IEC 60947-2 Approved) rated 15A or less.

7.2.3 Grounding

Be sure to provide protective ground, which must be class D for Japan (ground resistance of 100ohm or less). PE line of the power supply cable is available for grounding. Do not hold the ground in common with the ones for equipment which generates strong electromagnetic noise or high frequency.

▲ CAUTION

If the highly insulating fluid like fluorinated fluid is used as constant temperature recirculating fluid, static electricity will occur due to the flow friction. As customer units might be charged with the electricity, the equipment connected to the temperature control equipment should be grounded to eliminate the electricity.

7.2.4 Avoidance of Parallel Wiring

Avoid connecting a signal line such as for communications or external sensor or alarm in the same route as or in parallel to a power line or high voltage line.

7.2.5 Connection of Various Connectors and Power Supply Cable

- 1) Ensure that the power source and the power supply of the product is turned off before connecting the various connector and power supply cable.
- 2) When an external temperature sensor is connected, connect the sensor with a shield cable. Use a platinum resistant temperature sensor (Pt100ohm, 3-wiring type, class A, 2mA)
- 3) Connect the host to this unit with a twisted pair shield cable when applying communication function.
- 4) For alarm output, connect it with a twisted pair cable.

7.3 Supply of recirculating fluid

The recirculating fluid is supplied as described below.

1. Confirm the power switch is turned off.
2. Take off the reservoir cap of the Thermo-con.
3. Supply recirculating fluid for the reservoir. The inlet of the reservoir is not so large and spillage of recirculating fluid needs to be cared. Stop the supply once until the level of fluid reaches "H" level.
4. Turn on the power switch to fill the piping with the fluid.
5. When the piping is filled with the recirculating fluid, the level of the reservoir lowers and low recirculating fluid alarm (ERR20) arises accordingly. Then, turn off the power supply once again.
6. Repeat the step from 4 to 6 until ERR20 alarm doesn't come out. Then, put back the cap on the reservoir and tighten it securely.
7. Keep the fluid level between H and L of the level indicator.

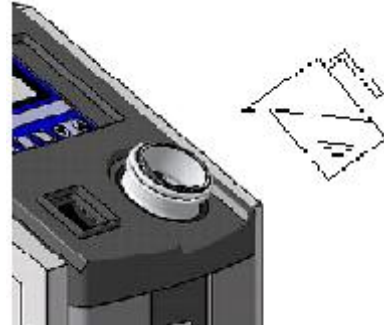

⚠ DANGER

Never touch the switch with wetted hand to avoid electrical shock.

⚠ WARNING

Recirculating fluid should be handled after checking protection devices and first-aid actions on the Material Safety Data Sheet (MSDS) of the using recirculating fluid.

⚠ CAUTION

Take enough care not to spill the feed water over the case when supplying water to the reservoir. When it is spilt by mistake, wipe it off immediately and supply the power after it dries. If this procedure is neglected, it may cause breakdown of the equipment.

⚠ CAUTION

If the fluid with low conductivity such as Fluorine solvent is used as recirculating fluid, it causes static electricity due to friction and damages the temperature sensor and other electric components of this unit. Take a measure to minimize static electricity from recirculating fluid.

⚠ CAUTION

If the power switch is turned on without recirculating fluid, the pump is damaged.

⚠ CAUTION

The recirculating fluid should be divided into containers with 4.5kg or less for the supply or feed the fluid using a pump without holding the containers with hands.

7.4 Check·Repair

The following checks shall be performed before operation.

7.4.1 Daily check

- 1) Indication of display panel: Check temperature condition and confirm whether or not the alarm occurs.
- 2) Check the recirculating fluid is not contaminated. Once the fluid is contaminated, it may degrade the performance or shorten the life time. When water is used, it's recommended that anti-alga agent should be used or replace the recirculating fluid about once a month as alga or bacteria deteriorates the recirculating fluid.
- 3) Confirm there is no leakage of recirculating fluid or no bending or crush of the piping of recirculating fluid.
- 4) Confirm there is no abnormal sound or smell or abnormal heating of the case.

▲ CAUTION

Operation of the pump with the plenty of air left in the piping for prolonged period may cause the pump to break. Exhaust the air enough from the piping before starting operation of the pump.

▲ CAUTION

Do not perform operation under the condition which lowers the flow rate significantly, such as closing the valve. Other wise, the temperature might be beyond control.

▲ CAUTION

The product is damaged when driving for a long term with the temperature staggered periodically after reaching the target temperature. Please set the PID value again by using auto-tuning function (see section4.7).

▲ CAUTION

The level of a tank should be checked once a day to keep the level within the appropriate range (H to L). The level may go down due to the evaporation of the recirculating fluid. When the level goes down “L” level, it may degrade the performance or damage the installed pump. Operate the unit with a proper level of fluid.

▲ CAUTION

The tank has negative pressure if sound like sucking air can be heard when the lid is loosened during operation. If the operation is continued, the tank may be broken. If the tank has negative pressure, remove the packing at the lid of the tank, and make it an open tank. Before removing the packing, confirm that fluid will not overflow such that thermostat recirculating fluid flows back.

▲ CAUTION

The volume of fluorinate fluid varies depending on the temperature. When the volume of the recirculating fluid expands (contracts) due to the temperature rise or decrease, inside of the tank will be pressurized (depressurized), leading to a deformation of the tank or leakage. When the set temperature is largely changed (for several tens of degree) while the fluorinated fluid is used, loosen the tank lid in the middle of the change to return the pressure in the tank to the atmospheric pressure..

7. 4. 2 Check after seismic vibration and impact

- 1) Piping: Confirm there is no defect including disconnection in piping.
- 2) Electrical wiring: Confirm there is disconnection of the connector from the cable.
- 3) Mounting condition: If the Thermo-con is mounted for operation, confirm the Thermo-con is mounted securely.
- 4) Recirculating fluid: Confirm there is no leakage.
- 5) Others: Confirm there is no abnormal sound or smell or abnormal heating of the case.

7. 4. 3 Repair and maintenance

The repair and maintenance services of this unit are performed only at our factory. The service requiring a trip regardless of inside and outside of Japan is not provided. When returning the product for repair or maintenance service, discharge all the fluid inside the Thermo-con in order to avoid fluid leakage during transportation, and seal it.

Additionally, it is recommended to prepare spare units to minimize downtime due to those repair and maintenance services.

▲ WARNING

Drain the fluid from Thermo-con when it is returned for the repair and maintenance service. If the fluid is left, an accident and damage can result during transportation.

8 Operation

This chapter describes the detailed information on how to operate.

8.1 Start of operation

8.1.1 Confirmation before operation

- 1) Confirm that the recirculating fluid has reached a L level
- 2) Supply radiating water.
- 3) Confirm that there is no incorrect wiring of the connected cables and turn on the power supply of the unit.
- 4) When power is turned on, software version is indicated on display panel for approx. 1 sec. (Ex. : 1.0)

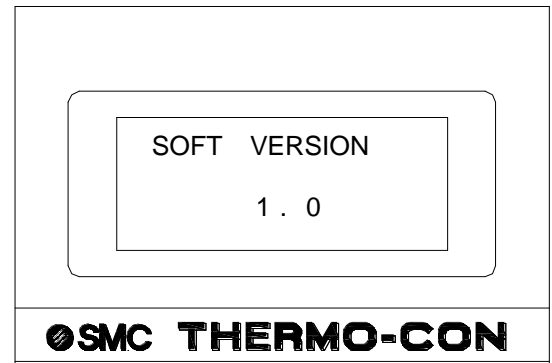

8.1.2 Setting of values

When the product has been found to start operating normally set the values such as temperature.(see section 8.3). Once the value is set, it will remain set even if the power supply is turned off.

▲ CAUTION

Be sure to operate the operation and display panel by finger. Using tools such as a screwdriver, pen, or pencil may damage the panel.

8.1.3 Cautions for Operation Control

- 1) Wait at least 30 min. the after power supply is turned on before operating to allow the product to warm up.
- 2) If an alarm occurs during operation, refer to section 9 for the remedy

▲WARNING

Do not operate the unit with remaining the outer panel open or removed. Contact with inside of the unit may cause injury or electric shock.

▲ CAUTION

The level of a tank should be checked once a day to keep the level within the appropriate range (H to L). The level may go down due to the evaporation of the recirculating fluid. When the level goes down "L" level, it may degrade the performance or damage the installed pump. Operate the unit with a proper level of fluid.

▲ CAUTION

If lower-temperature radiating water is supplied, dew may condense in the product and the equipment could be damaged. Keep the temperature above the atmospheric pressure dew point.

▲ CAUTION

Please do not use the device which generates the electromagnetic radiation such as cellular phones beside the unit. There is a possibility that the unit miss-operate.

8.2 How to operate

1. The different 3 levels are available depending on the content, which needs to be set.

Level 1 : Used normally and setting of target temp. and offset are included.(Refer to 8.3.)

Level 2 : Used at maintenance and initial setting and the setting of control PID is included.(Refer to 8.4.)

Level 3 : Used rarely for the purpose other than initial setting and communication setting is included. (Refer to 8.5)

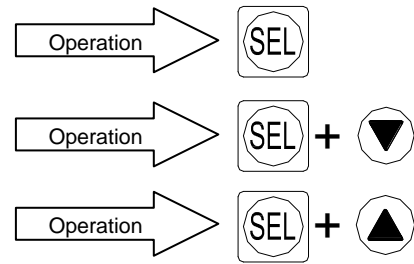

2. [SEL] key

Used to show the item, which needs to be changed in selected mode level.

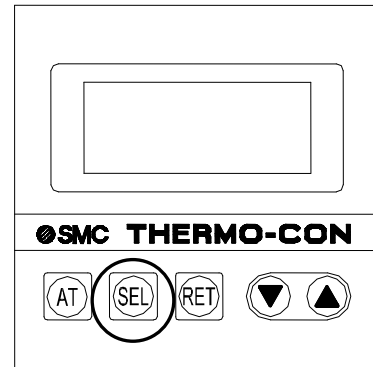

3. [▽△] key (up/down key)

Used to change the value of the item shown by [SEL] key.

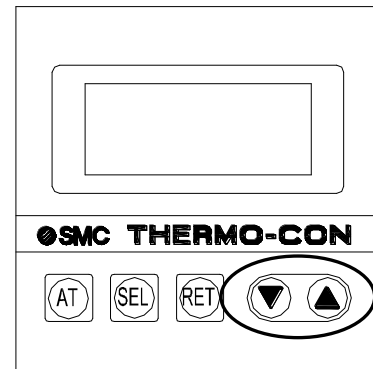

4. [RET] key

Used to fix the value changed by [▽△]key. Press once again to return to current temp. indication.

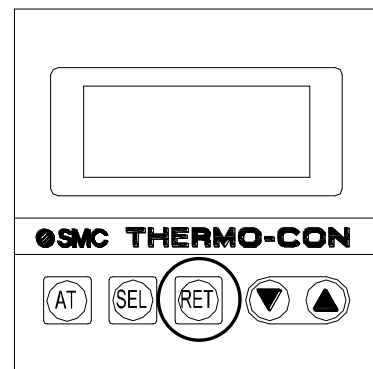

5. [AT] key

Used to start auto tuning in auto tuning mode (control operation mode : 2). When pressed during auto tuning, the auto tuning is suspended. (→ Refer to 5.3)

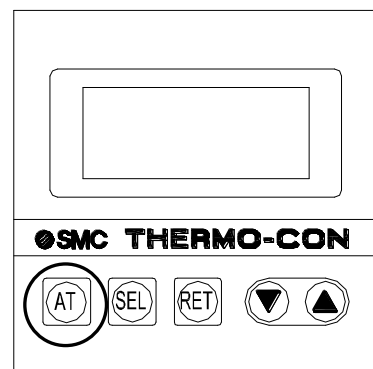

8.3 Setting Mode, Level 1

The method to enter to and return from setting mode Level 1 and which mode can be set in the level are explained below.

8.3.1 How to enter and return

Press [SEL] key while power is turned on. Then, the indication on [MODE] is changed depending on the number of press and the data in the indicated mode can be set. To return to current temperature indication, press [RET] key twice.

NOTE

When no input is done within 1 minute regardless of setting mode, the current temperature indication is returned automatically.

8.3.2 Available mode in Level 1

The mode which can be set in setting mode Level 1 is as shown on Table 8-1. The mode available in Level 1 is supposed to be used normally including target temp. and offset.

⚠ CAUTION

The inputted data is written in EEPROM and memorized after the power supply is turned off. The writing can be done up to 1 million times.

Table8-1 Available mode in Level 1

No.	Modes	Setting contents	Setting range (Min. increment)	Default
1	Target Temp. (No indication on display)	Sets target temp. for control.	10.0 to 60.0 °C (0.1 °C)	25.0
2	Control Operation	Selects control operation mode among them below 0 : Pump stop(No control) 1 : Normal(normal control operation) 2 : AT(auto tuning) 3: Learn (learning control) 4: External (external tune control)	0,1,2,3,4	1
3	External Sensor Sampling Cycle	Sets sampling cycle for learning control or external tune control. (Not indicated during normal control.)	10 to 999sec (1sec)	180
4	Offset Value	Enables control to temp. displaced from the actual temp. by modifying temp. measured by temp. sensor.	-9.99 to 9.99 °C (0.01 °C)	0.00
5	Allowable Upper Temp. Range	Sets upper limit of temp. range which causes the warning to arise.	0.1 to 10.0 °C (0.1 °C)	1.5
6	Allowable Lower Temp. Range	Sets lower limit of temp. range which causes the warning to arise.	0.1 to 10.0 °C (0.1 °C)	1.5
7	High Temp. Cutoff	Sets upper limit of temp. which the internal temp. sensor detects and judges the unit should be shut off.	11.0 to 70.0 °C (0.1 °C)	70.0
8	Low Temp. Cutoff	Sets lower limit of temp. which the internal temp. sensor detects and judges the unit should be shut off.	0.0 to 59.0 °C (0.1 °C)	0.0

* How to return default value: Turn on the power supply with pressing [SEL] and [RET] keys,. At this time, the settings of Level 2 and Level 3 are also reset.

8.4 Setting mode, Level 2

The method to enter to and return from setting mode Level 2 and which mode can be set in the level are explained below.

8.4.1 How to enter and return

Press [SEL] and [▽] keys at the same time while power is turned on. Then, the indication on [MODE] is changed depending on the number of press and the data in the indicated mode can be set. To return to current temp. indication, press [RET] key twice.

NOTE

When no input is done within 1 minute regardless of setting mode, the current temperature indication is returned automatically.

8.4.2 Available mode in Level 2

The mode, which can be set in setting mode Level 2, is as shown on Table 8-2. The mode available in Level 2 is supposed to be used normally for initial setting and maintenance and control PID is included.

NOTE

The inputted data is written in EEPROM and memorized after the power supply is turned off. The writing can be done up to 1 million times.

Table8-2 Available mode in Level 2

No.	Modes	Setting contents	Setting range (Min. increment)	Default
1	Fine Control of Internal Sensor	Sets the fine adjusting value to calibrate the internal temp. sensor.	-9.99 to 9.99 °C (0.01 °C)	0.00
2	Fine Control of External Sensor	Sets the fine adjusting value to calibrate the external temp. sensor available optionally.	-9.99 to 9.99 °C (0.01 °C)	0.00
3	PB Range	Sets PB (Proportional Band) range used for PID control.	0.3 to 9.9 °C (0.1 °C)	0.6 (3.0)
4	ARW Range	Sets integral operation range of PID control. ARW: Anti Reset Windup	0.3 to 9.9 °C (0.1 °C)	1.0 (3.3)
5	I Constant	Sets integral time used for PID control.	1 to 999sec (1sec)	150 (80)
6	D Constant	Sets differential time used for PID control. When 0 is set, differential operation is not made.	0.0 to 99.9sec (0.1sec)	0.0
7	Heating/Cooling Ratio	Sets output ratio of cooling to heating to compensate difference of gain between them.	10 to 999% (1%)	200
8	Overload Judging Temp. Range	Sets the temp. range for judgment of overload (accompanying abnormal output alarm ERR15).	0.1 to 9.9 °C (0.1 °C)	0.2
9	Overload Judging Time	Sets time for judgment of overload (accompanying abnormal output alarm ERR15). When 0 is set, the alarm doesn't arise.	0 to 99min (1min)	10
10	Output Ratio	Shows output ratio of thermo module by 1%. The prefix symbol "-" stands for cooling and no prefix stands for heating.	-100 to 100% (1%)	-
11	Upper/Lower Temp. Alarm Sequence	Determines whether or not temp. upper/lower limit alarm is output when power is turned on. On : Output Off : Not output	On,Off	Off

* How to return default value: Turn on the power supply with pressing [SEL] and [RET] keys. At this time, the settings of Level 1 and Level 3 are also reset.

* The default value indicated in () is inputted at the time of shipment from factory.

8.5 Setting mode, Level 3

The method to enter to and return from setting mode Level 3 and which mode can be set in the level are explained below.

8.5.1 How to enter and return

Press [SEL] and [Δ] keys at the same time while power is turned on. Then, the indication on [MODE] is changed depending on the number of press and the data in the indicated mode can be set. To return to current temp. indication, press [RET] key twice.

NOTE

When no input is done within 1 minute regardless of setting mode, the current temperature indication is returned automatically.

8.5.2 Available mode in Level 3

The mode, which can be set in setting mode Level 3, is as shown on Table 8-3. The mode available in Level 3 is supposed not to be used normally for the purpose other than initial setting and the setting related to communication is included.

NOTE

The inputted data is written in EEPROM and memorized after the power supply is turned off. The writing can be done up to 1 million times.

Table8-3 Available mode in Level 3

No.	Modes	Setting contents	Setting range (Min. increment)	Default
1	Unit Number	Sets the unit No. used. This is applicable only when multiple Thermo-con is used.	0 to F (Hex decimal)	0
2	Baud Rate	Sets baud rate for communication.	600,1200,2400,4800 9600,19200b/s	1200
3	Parity Bit	Sets parity bit for communication. Without : No parity Odd : Odd Even : Even	Without, Odd, Even	Without
4	Data Length	Sets data length for communication.	7Bits, 8Bits	8
5	Stop Bit	Sets stop bit for communication.	1Bit, 2Bits	1

* How to return default value: Turn on the power supply with pressing [SEL] and [RET] keys. At this time, the settings of Level 1 and Level 2 are also reset.

8. 6 Detail of setting mode level

The each setting mode level is explained below in detail.

8. 6. 1 Setting mode, Level 1

1. Indication of current temperature

Indication range: -9.9 to 80.0 °C

Min. increment: 0.1 °C

Indicated content: #1 Temperature detected by internal temp. sensor

#2 Temperature detected by external temp. sensor

(When the external sensor is not connected, "HHH" would be indicated.)

#1 and #2 change when [△] or [▽] is pressed.

```
P V < 23.0°C # 1
S V    25.0°C
MODE
```

```
P V < 23.0°C # 2
S V    25.0°C
MODE
```

2. Target temperature (no indication on display)

Setting range : 10.0 to 60.0 °C

Min. increment : 0.1 °C

Indicated content : [SV] : Target temp.(Ex. : 25.0 °C)

Function : Sets target temperature

```
P V    23.0°C # 1
S V < 25.0°C
MODE
```

3. Control Operation

Setting range : 0,1,2,3,4

Indicated content : Number and description of control operation mode.(Ex. : 1:Normal)

Function : Selects control operation mode among them below

- 0 : Stop of control (Pump Stop)
- 1 : Normal (normal control operation)
- 2 : AT (auto tuning)
- 3 : Learning control (Learn)
- 4 : External tune control (External)

```
Control
Operation
MODE < 1: Normal
```

When a learning control and an external tuning control are selected, measurement temperature (#2) of an external temperature sensor is displayed.

When an external tuning control is selected, the target temperature is changed at any time. When the control mode changes from external tune mode to normal mode, the target temperature returns to the previous value.

<How to perform auto tuning>

- 1) Select "2" in control operation.
- 2) Press [AT] key to light up "AT" indicator. The auto tuning starts.
- 3) To stop auto tuning, press [AT] key again. ("AT" indicator goes off.)
- 4) When auto tuning is finished, "AT" indicator goes off. If the auto tuning is not finished over 20min, [ERR19] (AT error) arises.
- 5) If the auto tuning fails, return to the set value at the time of shipment from factory (refer to Table 8-2) or input optimum value.

4. External sensor sampling cycle setting mode

Setting range: 10 to 999sec

Min. increment: 1sec

Indicated content: External sensor sampling cycle (Ex.: 180sec)

Function: Sets sampling cycle of external sensor for learning control or external tune control.

```
External Sensor
Sampling Cycle
MODE < 180 sec
```

5. Offset Value

Setting range : -9.99 to 9.99 °C

Min. increment : 0.01 °C

Indicated content : Offset value(Ex. : -0.15 °C)

Function : This is a function to control temperature sliding it by offset value from set point temperature.

For example, if -0.15 °C is set in this item, the actual temp. should be regarded to be lower than the indicated one by 0.15 °C.

```
Offset Value
MODE< -0.15 °C
```

6. Allowable Upper Temp. Range

Setting range : 0.1 to 10.0 °C

Min. increment : 0.1 °C

Indicated content : Temp. from target to upper limit
(Ex.: 1.5 °C)

Function : Sets upper limit of temp. where the warning arises. The difference between target temp. and upper limit temp. should be input. Therefore, if the target temp. is 23.0 °C and 1.5 °C is set in this item, the warning [WRN] arises when temp. exceeds 24.5 °C.

```
Allowable Upper
Temp. Range
MODE< 1.5 °C
```

7. Allowable Lower Temp. Range

Setting range : 0.1 to 10.0 °C

Min. increment : 0.1 °C

Indicated content : Temp. from target to lower limit
(Ex. : 1.5 °C)

Function : Sets lower limit of temp. where the warning arises. The difference between target temp. and lower limit temp. should be input. Therefore, if the target temp. is 23.0 °C and 1.5 °C is set in this item, the warning [WRN] arises when temp. lowers 21.5 °C.

```
Allowable Lower
Temp. Range
MODE< 1.5 °C
```

8. High Temp. Cutoff

Setting range : 11.0 to 70.0 °C

Min. increment : 0.1 °C

Indicated content : High temp. cutoff by internal temp. sensor (Ex. : 70.0 °C).

Function : Sets upper limit of temp. which the internal temp. sensor detects and judges the unit should be shut off. When the temp. set in this item is reached, the alarm [ERR12] arises.

```
High Temp.
Cutoff
MODE< 70.0 °C
```

9. Low Temp. Cutoff

Setting range : 0.0 to 59.0 °C

Min. increment : 0.1 °C

Indicated content : Low temp. cutoff by internal temp. sensor (Ex. : 0.0 °C)

Function : Sets lower limit of temp. which the internal temp. sensor detects and judges the unit should be shut off. When the temp. set in this item is reached, the alarm [ERR13] arises.

```
Low Temp. Cutoff
MODE< 0.0 °C
```

8. 6. 2 Setting mode, Level 2

1. Fine Control of Internal Sensor

Setting range : -9.99 to 9.99 °C

Min. increment : 0.01 °C

Indicated content : Fine adjusting value for internal temp. sensor (Ex. : -0.07 °C)

Function : Sets the fine adjusting value to calibrate the internal temp. sensor. If -0.07 °C is set in this item, the reading of temp. sensor is higher by 0.07 °C and actually, the temp. is controlled to lower one by 0.07 °C.

```
Fine Control of
Internal Sensor
MODE< -0.07 °C
```

2. Fine Control of External Sensor

Setting range : -9.99 to 9.99 °C

Min. increment : 0.01 °C

Indicated content : Fine adjustment value for external temp. sensor(Ex. : 0.05 °C)

Function : Sets the fine adjusting value to calibrate the external temp. sensor if it is mounted optionally. If 0.05 °C is set in this item, the reading of temp. sensor is lower by 0.05 °C and actually, the temp. is controlled to higher one by 0.05 °C.

```
Fine Control of
External Sensor
MODE< 0.05 °C
```

3. PB Range

Setting range : 0.3 to 9.9 °C

Min. increment : 0.1 °C

Indicated content : PB range(Ex. : 2.0 °C)

Function : Sets PB (Proportional Band) range used for PID control.

```
PB Range
MODE< 2.0 °C
```

4. ARW Range

Setting range : 0.3 to 9.9 °C

Min. increment : 0.1 °C

Indicated content : ARW range (Ex.: 2.2 °C)

Function : Sets integral operation range of PID control. If this value is set less than PB range, the set temperature can't be achieved. Therefore set it above PB range.

```
ARW Range
MODE< 2.2 °C
```

ARW: Anti Reset Windup

5. I Constant

Setting range : 1 to 999sec

Min. increment : 1sec

Indicated content : I constant(Ex. : 50sec)

Function : Sets integral time used for PID control.

```
I Constant
MODE< 50 sec
```

6. D Constant

Setting range : 0.0 to 99.9sec

Min. increment : 0.1sec

Indicated content : D constant(Ex. : 0.0sec)

Function : Sets differential time used for PID control.

When 0 is set, this function becomes invalid.

```
D Constant
MODE< 0.0 sec
```

7. Heating/Cooling Ratio

Setting range : 10 to 999%

Min. increment : 1%

Indicated content : Heating/cooling gain ratio(Ex. : 200%)

Function: Sets output ratio of cooling to heating to compensate difference of gain between them.

```
Heating / Cooling
Ratio
MODE< 200 %
```

8. Overload Judging Temp. Range

Setting range : 0.1 to 9.9 °C

Min. increment : 0.1 °C

Indicated content : Overload judging temp. range
(Ex. : 0.2 °C)

Function : Sets the temp. range for judgment of overload (accompanying abnormal output alarm ERR15).

```
Overload Judging
Temp. Range
MODE< 0.2 °C
```

9.Overload Judging Time

Setting range : 0 to 99min

Min. increment : 1min

Indicated content : Overload judging time(Ex. : 10min)

Function : Sets time for judgment of overload (accompanying abnormal output alarm ERR15). When 0 is set, the alarm doesn't arise.

```
Overload Judging
Time
MODE< 10 min
```

10. Output indication mode [Output Ratio]

Setting range : -100 to 100%

Min. increment : 1%

Indicated content: Thermo module output ratio (Ex.: -73%)

Function: Indicates Thermo module output ratio with increment of 1%. "+" is not indicated but "+" means heating and "-" means cooling.

```
Output Ratio
MODE< - 73 %
```

11.Upper/Lower Temp. Alarm Sequence

Setting range : On,Off

Indicated content : Use of temp. upper/lower limit alarm sequence(Ex. : Off)

Function : Determines whether or not temp. upper/lower limit alarm is output when power is turned on.

On : Output

Off : Not output (Alarm for high and low temperature limit is not detected until the temperature reaches the target temperature after the power is supplied.)

```
Upper / Lower Temp.
Alarm Sequence
MODE< Off
```

8. 6. 3 Setting mode, Level 3

1. Unit Number

Setting range : 0 to F (Hex decimal)

Indicated content : Unit number (Ex. : 0)

Function : Sets unit number used. This item is applicable only when multiple units are used.

```
Unit Number
MODE< 0
```

2. Baud Rate

Setting range : 600, 1200, 2400, 4800, 9600, 19200b/s

Indicated content : Baud rate (Ex. : 1200b/s)

Function : Sets baud rate for communication.

```
Baud Rate
MODE< 1200 b / s
```

3. Parity Bit

Setting range : Without (no parity), Odd, Even

Indicated content : Parity bit (Ex. : Without)

Function : Sets parity bit for communication.

```
Parity Bit
MODE< Without
```

4. Data Length

Setting range : 7Bits, 8Bits

Indicated content : Data length(Ex. : 8Bits)

Function : Sets data length for communication.

```
Data Length
MODE< 8 Bits
```

5. Stop Bit

Setting range : 1Bit,2Bits

Indicated content : Stop bit(Ex. : 1Bit)

Function : Sets stop bit for communication.

```
Stop Bit
MODE< 1 Bit
```

9 Alarm

The unit has various alarms explained below.

9.1 How to Identify Alarm

The alarm is identified as shown on the following table.

Table9-1 Alarm information

No.	Condition	After Alarm Occurrence	Indication example
1	Power supply on	After indication of software version, the error No.[ERR**] starts blinking and then the contents of the error comes out. As [MODE], "Shut Off" is indicated. (“Continuity” is indicated instead for ERR15 and ERR18 because the operation is continued.)	Fig.9-1
2	Normal operation	The value of PV and SV disappear and instead, the error No. [ERR**] starts blinking and the content of the error comes out. As [MODE], "Shut Off" is indicated. (“Continuity” is indicated instead for ERR15 and ERR18 because the operation is continued.)	
3	Set value input	Even during input of each setting, the error No. [ERR**] starts blinking on the upper side. After input (pressing [RET]key to set), the content of the error comes out(like Fig.9-1).	Fig.9-2
4	Temp. upper/lower limit alarm occurrence	The value of PV and SV and the indication of [MODE] remained [WRN] lights up. After the error is reset, the indication of [WRN] disappears.	Fig.9-3

9.2 Alarm indication

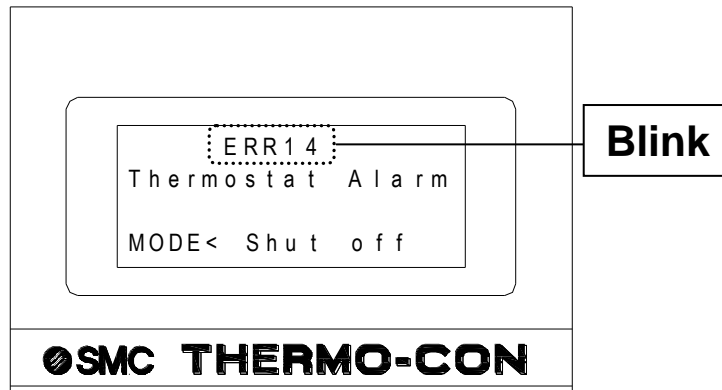

Fig.9-1 Alarm indication in the event ERR14 arises

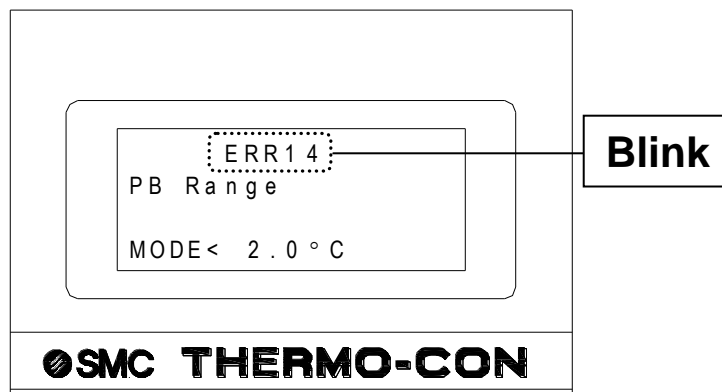

Fig.9-2 Alarm indication in the event ERR14 arises during PB range setting input

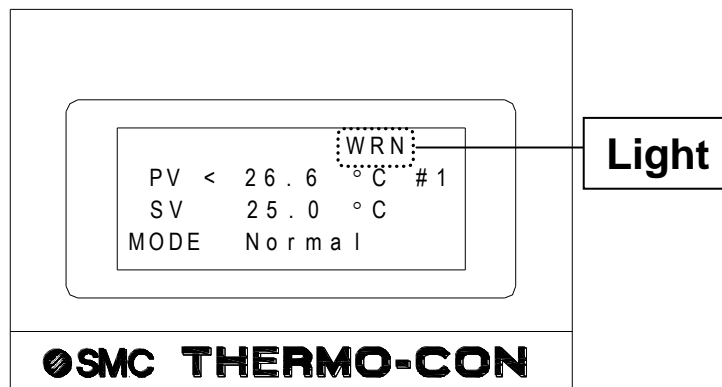

Fig.9-3 Alarm indication in the event temp. upper and lower limit arises

9.3 How to reset alarm

The alarm can be reset in the following manner.

Table9-2 Reset of alarm

No.	Alarm code	Description	Manner of reset
1	ERR00	CPU hung-up	Restart the power supply.
2	ERR01	CPU check error	In the case the alarm can't be reset by above manner, repair is required.
3	ERR03	Backup data error	Initialization of EEPROM or stop and restart of power supply In the case the alarm can't be reset by above manner, repair is required.
	ERR04	EEPROM wiring error	
4	Others		Removal of possible cause and restart of power supply. In the case the alarm can't be reset by above manner, repair is required.

9.4 Alarm code list

The alarm has individual code sent from controller as listed below.

Table9-3 Alarm code list

Code	Description	Contents
WRN	Temp. upper/lower limit	Condition : Fluid temp. is out of limit range. After alarm occurrence : The unit continues controlling and recovers normal condition at any time. Indication : [WRN] indicator lamp lights up.(Fig9-3)
ERR00	CPU hung-up	Condition : CPU hung-up due to noise etc. After alarm occurrence : The unit and communication stop. Indication : [Hung-up of CPU]
ERR01	CPU check failure	Condition : The content of CPU can't be read correctly when the power supply is turned on. After alarm occurrence : The unit and communication stop. Indication : [CPU Check Failure]
ERR03	Back-up data error	Condition : The content of back-up data can't be read correctly when power is turned on. After alarm occurrence : The unit and communication stop. Indication : [Back-up Data Error]
ERR04	EEPROM writing error	Condition : EEPROM doesn't allow writing of the data. After alarm occurrence : The unit and communication stop. Indication : [EEPROM Writing Error]

Note1) When [WRN: Temp. upper/lower limit alarm] occurs, alarm is output to alarm output connector (Temperature alarm) by relay contact.

Note2) When [ERR00-ERR20] occurs, alarm is output to alarm output connector (Output cutoff alarm) by relay contact.

*Refer to [10-1 Signal of connector]

Code	Description	Contents
ERR11	DC power supply failure	Condition : Switching power supply has a problem (The fan stops and temperature is excessively high.) or Thermo-module is short circuited. After alarm occurrence : The unit (temp. control, pump) stop. Indication : [DC Power Voltage Failure]
ERR12	High temp. cutoff.	Condition : Fluid temp. becomes higher than high temp. cutoff setting. Default : 70.0 °C After alarm occurrence : The unit (temp. control, pump) stop. Indication : [Internal Sensor Value is High]
ERR13	Low temp. cutoff.	Condition : Fluid temp. becomes lower than low temp. cutoff setting. Default : 0.0 °C After alarm occurrence : The unit (temp. control, pump) stop. Indication : [Internal Sensor Value is Low]
ERR14	Thermostat Alarm	Condition : Alerts when the thermostat is operated due to breakdown of fan or pump, etc. Thermostat working temp. : 60+/-5 °C (at radiating water side) 90+/-5 °C (at recirculating fluid side) After alarm occurrence : The unit (temp. control, pump) stop. Indication : [Thermostat Alarm]
ERR15	Abnormal output	Condition : Temperature change is less than overload judging temp. range even by 100% output for overload judging time period due to application of unacceptable heat load or broken of Thermo-module. Default : 0.2 °C 10min After alarm occurrence : The unit continues controlling except that output failure alarm arises. Indication : [Output Failure Alarm]
ERR16	Pump failure (only HEC012)	Condition : .The pump stop by the overload. After alarm occurrence : The unit (temp. control, pump) stop. Indication : [Flow Alarm]
ERR17	Breakage of internal temp. sensor	Condition : The internal temp. sensor is broken or disconnected. After alarm occurrence : The unit (temp. control, pump) stop. Indication : [Cutoff/Short of Internal Sensor]
ERR18	Disconnection of external temp. sensor	Condition: The external temp. sensor is disconnected or not mounted. (This condition is detected only in learning control or external tune control.) After alarm occurrence : The unit continues controlling at normal control. Indication : [Cutoff/Short of External Sensor]
ERR19	Abnormal auto tuning	Condition : The auto tuning could not finish within 20min. After alarm occurrence : The unit (temp. control, pump) stop. Indication : [AT Failure]
ERR20	Low liquid level	Condition : The level of recirculating fluid in the reservoir lowers. After alarm occurrence : The unit (temp. control, pump) stop. Indication : [Low Liquid Level Alarm]

Internal sensor value for alarm is the value that fine control value is decreased from internal sensor value and offset value is not included.

Internal sensor value from alarm = [Internal sensor value] - [Internal sensor fine control value]

9.5 Troubleshooting

Coping method when the alarm alerts is explained as follows.

Table9-4 Troubleshooting

Code	Reason for alarm setting	Cause
ERR00	(1) High level noise entered the power line, ground line, or temp. sensor line.	(1) Move the Thermo-con to an environment with little noise, turn ON the power supply. If there is no alarm, it causes from noise. Please consult with us.
ERR01	(1) High level noise entered the power line, ground line, or temp. sensor line.	(1) Move the Thermo-con to an environment with little noise, turn ON the power supply. If there is no alarm, it causes from noise. Please consult with us.
ERR03	(1) The EEPROM data was destroyed by high level noise.	(1) Move the Thermo-con to an environment with little noise, turn ON the power supply. If there is no alarm, it causes from noise. Please consult with us.
ERR04	(1) Controller EEPROM data has been broken due to high level noise. (2) Writing frequency to EEPROM exceeds product guarantee value (1,000,000 times).	(1)(2)Request the repair if the alarm can't be reset.
ERR11	(1) DC output voltage of Thermo-con is decreased. (2) Voltage sag happens.	(1) Check the power voltage 200 to 220VAC (2) If voltage sag lasts over specified value of 50msec, the output of DC power supply lowers and occurrence of alarm results. Supply the power to the extent so that such voltage sag will not happen.
ERR12	(1) Internal temp. sensor value exceeds the high temp. cutoff temperature. (2) Flow rate becomes zero.	(1) Check the set value for high temp. cutoff temperature and confirm the temperature really reaches abnormal value. (2) If flow rate of recirculating fluid becomes zero, the temperature of recirculating fluid can't be detected and might increase. Confirm the flow of recirculating fluid isn't prevented by valve etc.
ERR13	(1) Internal temp. sensor value becomes lower than low temp. cutoff temperature. (2) Flow rate of recirculating fluid becomes zero.	(1) Check the set value for low temp. cutoff temp. and confirm the temperature really reaches abnormal value. (2) If flow rate of recirculating fluid becomes zero, the temperature of recirculating fluid can't be detected and might decrease. Confirm the flow of recirculating fluid isn't prevented by valve etc.

ERR14	<p>(1) Radiating water temp is high or flow rate is not enough.</p> <p>(2) Flow rate becomes zero.</p> <p>(3) The pump breaks.</p>	<p>(1) Decrease radiating water temp. and increase a flow rate.</p> <p>(2)(3) If flow rate of recirculating fluid becomes zero, the temperature of recirculating fluid can't be detected and the temperature of heatexchanger might increase. Confirm the flow of recirculating fluid isn't prevented.</p>
ERR15	<p>(1) Cooling or heating capacity over by loaded.</p> <p>(2) Capacity of recirculating fluid is too large.</p>	<p>(1) If PV temp. changes when the set temp. is raised and down, it causes overload.</p> <p>(2) If the capacity of recirculating fluid is too large, the change of temperature takes much time. In this case, provide setting which can prevent occurrence of alarm. (Refer to 8.6.2.9)</p>
ERR16	<p>The over current flowed to the pump. (HEC012 only)</p>	<p>Check the power voltage 200 to 220VAC</p> <p>Checked the level gauge of the reservoir within the appropriate range (H to L).</p>
ERR17	<p>High level noise entered the temp. sensor line.</p>	<p>Check the temperature unstable occurred by noise. Please consult us if it causes noise.</p>
ERR18	<p>The external temp. sensor is not mounted.</p>	<p>For learning control or external tune control, be sure to mount the external temp. sensor.</p>
ERR19	<p>Capacity of recirculating fluid is too large.</p>	<p>Adjust PID value (proportional band, ARW value, integral time and derivative time) of setting mode Level 2 by hand.</p>
ERR20	<p>(1) Fluid amount of reservoir is not enough.</p> <p>(2) Fluid is leaking.</p>	<p>(1) Supply fluid.</p> <p>(2) Check the connected part for external piping of Thermo-con.</p>
<p>Temperature rises and falls +/-1 to 2 °C gradually about the set point temperature.</p>	<p>(1) Flow rate of recirculating fluid is a little.</p> <p>(2) PID parameters are wrong value.</p>	<p>(1) Keep the flow rate 3L/min or more.</p> <p>(2) If the temperature can't be stable at default value, perform auto tuning.</p>

10 Appendix

The signal and shape of each connector and the method to calculate dew point are explained below.

10.1 Signal and style of connectors

The signal and style of each connector attached to the Thermo-con are as shown on the table below.

Table10-1 Signal and style of connectors

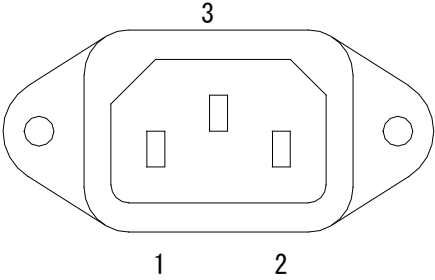
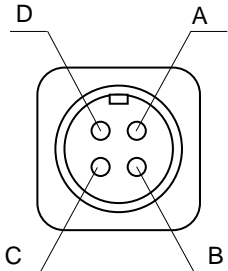
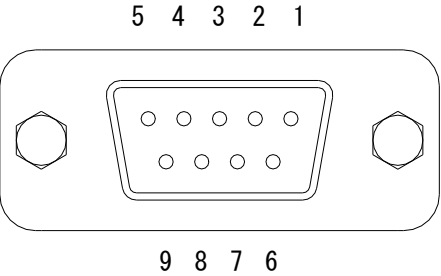
Description	No.	Signal		Style and Part No.
Power supply connector (HEC006)	1	AC200-220V		
	2	AC200-220V		
	3	PE		
Power supply connector (HEC012)	A	AC200-220V		
	B	AC200-220V		
	C	Unused		
	D	PE		
Communication connector		RS-232C	RS-485	 <p>D-sub 9 pin (socket type) Fixed screw: M2.6</p>
	1	Unused	BUS +	
	2	RXD (RD)	BUS -	
	3	TXD (SD)	Unused	
	4	Unused	Unused	
	5	SG	SG	
	6-9	Unused	Unused	

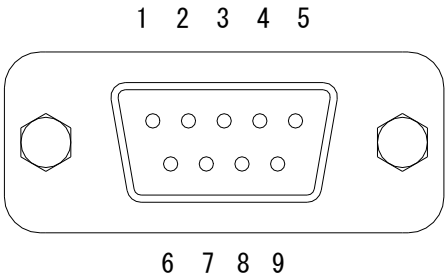
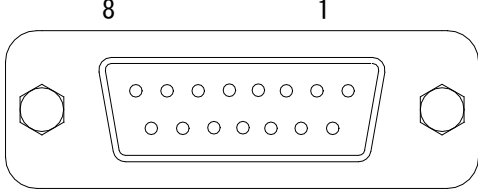
Description	No.	Signal	Style and Part No.
Alarm Output connector	1	Output Cutoff Alarm a contact (OPEN During Alarm)	 <p>D-sub 9 pin (Pin type) Fixed screw: M2.6</p>
	2	Output Cutoff Alarm Common	
	3	Output Cutoff Alarm b contact (CLOSE During Alarm)	
	6	Temperature Alarm a contact (OPEN During Alarm)	
	7	Temperature Alarm Common	
	8	Temperature Alarm b contact (CLOSE During Alarm)	
External temperature sensor connector	3	Resistance Bulb Terminal A	 <p>D-sub 15 pin (Socket type) Fixed screw: M2.6</p>
	4	Resistance Bulb Terminal B	
	5	Resistance Bulb Terminal B	
	15	FG	

10.2 Power Supply Cable

Table 10-2 Power Supply Cable

Description	Specifications	
	HEC006	HEC012
Connector	Rating Voltage: 250V Rating Current: 10A	Rating Voltage: 250V Rating Current: 23A
Cable	Rating Voltage: 300V AWG14 Color: Black AC200 to 220V Green/Yellow PE	Rating Voltage: 300V AWG14 Color: Black AC200 to 220V Green/Yellow PE

⚠ CAUTION

Do not use attached power supply cable for any purposes other than connection to this unit.

10.3 Calculation of dew point (from psychrometric chart)

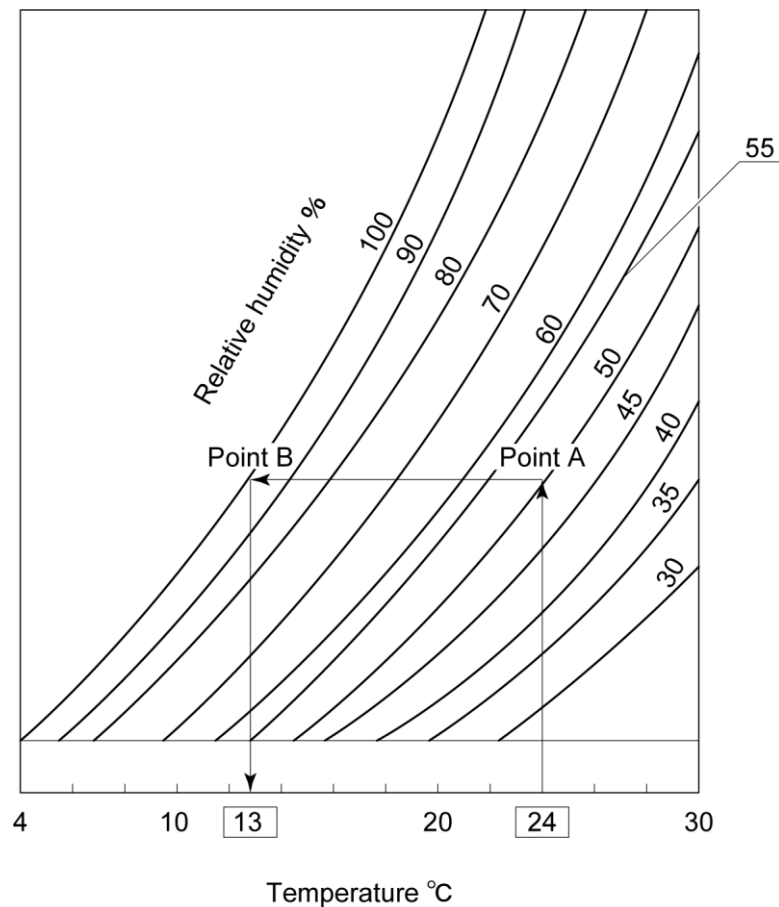

Fig.10-1 Moisture air diagram

- 1) Measure ambient temperature and humidity.
- 2) Plot ambient temperature to the temperature of horizontal axis (Ex. 24 °C), and then draw perpendicular line.
- 3) Obtain intersection (A) of the curve, which is almost equal to ambient temperature (Ex. 50%) and the perpendicular of 2).
- 4) Draw a line from (A) in parallel to temperature axis, and obtain the intersection (B) of that line and the curve of relative humidity 100%.
- 5) Draw perpendicular line from the intersection (B). (13 °C in this case.)

*Therefore, moisture in the air starts to condensate when the air temperature becomes lower than this temperature.

Revision history

SMC Corporation

4-14-1, Sotokanda, Chiyoda-ku, Tokyo 101-0021 JAPAN

Tel: + 81 3 5207 8249 Fax: +81 3 5298 5362

URL <http://www.smcworld.com>

Note: Specifications are subject to change without prior notice and any obligation on the part of the manufacturer.
© 2016 SMC Corporation All Rights Reserved