



Operation Manual

Installation · Operation

Original Instructions

Thermo chiller

HRSH090 Series

HRSH090-A ❌-20-❌

HRSH090-A ❌-40-❌ (€

HRSH090-W ❌-20-❌

HRSH090-W ❌-40-❌ (€

HRSH090-A ❌-20-❌-S (€

HRSH090-W ❌-20-❌-S (€

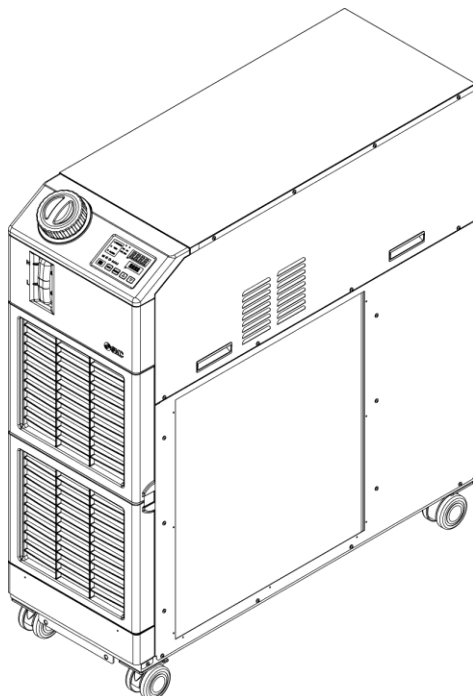

Keep this manual available whenever necessary

To the users

Thank you for purchasing SMC's Thermo chiller (hereinafter referred to as the "product").

For safety and long life of the product, be sure to read this operation manual (hereinafter referred to as the "manual") and clearly understand the contents.

- Be sure to read and follow all instructions noted with "Warning" or "Caution" in this manual.
- This manual is intended to explain the installation and operation of the product. Only people who understand the basic operation of the product through this manual or who perform installation and operation of or have basic knowledge about industrial machines are allowed to work on the product.
- This manual and other documents attached to the product do not constitute a contract, and will not affect any existing agreements or commitments.
- It is strictly prohibited to copy this manual entirely or partially for the use by a third party without prior permission from SMC.

Note: This manual is subject to possible change without prior notice.

Contents

Chapter 1	Safety Instructions	1-1
1.1	Before using the product.....	1-1
1.2	Reading the Manual	1-1
1.3	Hazards	1-2
1.3.1	Level of hazards	1-2
1.3.2	Definition of “Serious injury” and “Minor injury”	1-2
1.4	Product Label	1-3
1.5	Safety Measures	1-4
1.5.1	Safety Instructions for Use	1-4
1.5.2	Personal Protective Equipment.....	1-4
1.6	Emergency Measures.....	1-5
1.7	Waste disposal	1-5
1.7.1	Disposal of refrigerant and compressor oil.....	1-5
1.7.2	Disposal of product.....	1-5
1.8	Material Safety Data Sheet (MSDS)	1-6
Chapter 2	Name and Function of Parts	2-1
2.1	Model number of product	2-1
2.2	Name and Function of Parts	2-2
2.2.1	HRS090-A*-20/40-*(In case of air cooled type).....	2-2
2.2.2	HRS090-W*-20/40-*(In case of water cooled type)	2-3
2.3	Function of Parts.....	2-4
2.4	Operation display panel.....	2-5
Chapter 3	Transport and Setting Up.....	3-1
3.1	Transport.....	3-1
3.1.1	Moving by forklift	3-2
3.1.2	Moving by casters	3-3
3.2	Installation	3-4
3.2.1	Environment	3-4
3.2.2	Location.....	3-6
3.2.3	Installation and Maintenance Space	3-7
3.3	Installation	3-8
3.3.1	Installation	3-8
3.3.2	Electrical wiring	3-11
3.3.3	Preparation and wiring of power supply cable	3-12
3.3.4	Contact input/output communicatin wiring	3-17
3.3.5	Wiring of Run/stop signal input·Remote signal input.....	3-17
3.3.6	Wiring of external switch signal input	3-20
3.3.7	Wiring of operation signal output and alarm signal output	3-23

3.3.8	RS-485 Communication wiring	3-24
3.3.9	RS-232C Communication wiring	3-25
3.4	Piping.....	3-26
3.5	Fill of circulating fluid.....	3-29
3.6	Option J Piping of [Automatic fluid filling]	3-31
Chapter 4	Starting the Product.....	4-1
4.1	Before Starting	4-1
4.2	Preparation for Start	4-2
4.2.1	Power supply	4-2
4.2.2	Setting of circulating fluid temperature	4-3
4.2.3	Setting of pump operation mode	4-3
4.3	Preparation of circulating fluid	4-4
4.4	Starting and Stopping.....	4-7
4.4.1	Starting the product	4-7
4.4.2	Stopping the product.....	4-8
4.5	Check items after starting	4-9
4.6	Adjustment of Circulating Fluid flow rate	4-9
Chapter 5	Display and setting of various functions	5-1
5.1	List of function.....	5-1
5.2	Function.....	5-2
5.2.1	Key operations.....	5-2
5.2.2	List of parameters.....	5-4
5.3	Main screen	5-7
5.3.1	Main screen	5-7
5.3.2	Display on the main screen	5-7
5.4	Alarm display menu	5-8
5.4.1	Alarm display menu	5-8
5.4.2	Content of display of alarm display menu.....	5-8
5.5	Inspection monitor menu	5-9
5.5.1	Inspection monitor menu	5-9
5.5.2	Checking of the Inspection monitor menu	5-9
5.6	Key-lock.....	5-14
5.6.1	Key-lock	5-14
5.6.2	Key-lock setting / checking	5-15
5.7	Run timer, stop timer function	5-16
5.7.1	Run timer and stop timer function.....	5-16
5.7.2	Setting and checking of Run timer and stop timer function	5-18
5.8	Ready completion (TEMP READY) signal	5-20
5.8.1	Ready completion (TEMP READY) signal.....	5-20
5.8.2	Ready completion (TEMP READY) signal setting / checking.....	5-21

5.9	Offset function.....	5-23
5.9.1	Offset function	5-23
5.9.2	Offset function setting and checking	5-25
5.10	Function to recover from power failure	5-27
5.10.1	Function to recover from power failure.....	5-27
5.10.2	Function to recover from power failure setting and checking.....	5-28
5.11	Anti-freezing function	5-29
5.11.1	Anti-freezing function.....	5-29
5.11.2	Anti-freezing function setting and checking.....	5-30
5.12	Key click sound setting	5-31
5.12.1	Key click sound setting.....	5-31
5.12.2	Key click sound setting and checking	5-31
5.13	Temperature unit switching.....	5-32
5.13.1	Temperature unit switching.....	5-32
5.13.2	Temperature unit switching setting and checking.....	5-32
5.14	Pressure unit switching	5-33
5.14.1	Pressure unit switching	5-33
5.14.2	Pressure unit switching setting and checking	5-33
5.15	Data reset function.....	5-34
5.15.1	Data reset function	5-34
5.15.2	Method of resetting data reset function.....	5-34
5.16	Accumulated time reset function	5-35
5.16.1	Accumulated time reset function	5-35
5.16.2	Method of resetting accumulated time reset function	5-35
5.17	Pump operation mode function.....	5-39
5.17.1	Pump operation mode	5-39
5.17.2	How to check the pump operation mode and value setting	5-39
5.18	Warming up function.....	5-42
5.18.1	Warming up function.....	5-42
5.18.2	Warming up function setting and checking	5-43
5.19	Alarm buzzer sound setting.....	5-45
5.19.1	Alarm buzzer sound setting.....	5-45
5.19.2	Alarm buzzer sound setting and checking.....	5-45
5.20	Alarm customizing function	5-46
5.20.1	Alarm customizing function	5-46
5.20.2	Alarm customize function setting and checking	5-50
5.20.3	Setting of temperature alarm monitoring method and alarm generation timing.....	5-62
5.21	Communication function	5-69
5.21.1	Communication function.....	5-69
5.21.2	Communication function setting and checking.....	5-69

Chapter 6	Option	6-1
6.1	Option M [DI water (Pure water) piping]	6-1
6.1.1	Option M [DI water (Pure water) piping]	6-1
6.2	Option J [Automatic fluid filling]	6-2
6.2.1	Option J [Automatic fluid filling]	6-2
Chapter 7	Alarm indication and trouble shooting	7-1
7.1	Alarm Display	7-1
7.2	Alarm buzzer stop	7-3
7.3	Troubleshooting	7-4
7.3.1	Alarm contents, causes and remedies	7-4
7.3.2	How to release the fan breaker trip	7-8
7.3.3	How to release the pump thermal trip	7-10
7.4	Other Errors	7-12
Chapter 8	Control, Inspection and Cleaning	8-1
8.1	Control of Circulating Fluid, facility water Quality	8-1
8.2	Inspection and Cleaning	8-2
8.2.1	Daily check	8-2
8.2.2	Monthly check	8-3
8.2.3	Inspection every 3 months	8-4
8.2.4	Inspection every 6 months	8-5
8.2.5	Inspection for winter season	8-6
8.3	Consumables	8-6
8.4	Stop for a Long Time	8-7
8.4.1	Drain of the circulating fluid	8-7
8.4.2	Drain of the facility water	8-9
Chapter 9	Documents	9-1
9.1	Specifications	9-1
9.1.1	HRSH090-A*-20-*	9-1
9.1.2	HRSH090-A*-40-*	9-2
9.1.3	HRSH090-W*-20-*	9-3
9.1.4	HRSH090-W*-40-*	9-4
9.1.5	Refrigerant with GWP reference	9-5
9.1.6	Communication specification	9-6
9.2	Outline dimensions	9-7
9.2.1	HRSH090-A*-20/40-*	9-7
9.2.2	HRSH090-W*-20/40-*	9-8
9.3	Flow diagram	9-9
9.3.1	HRSH090-A*-20/40-*	9-9
9.3.2	HRSH090-W*-20/40-*	9-9
9.4	Cooling capacity	9-10

9.4.1	HRSH090-A*-20-*	9-10
9.4.2	HRSH090-A*-40-*	9-10
9.4.3	HRSH090-W*-20-*, HRSH090-W*-40-*	9-11
Pump capacity		9-12
9.4.4	HRSH090-A*-20/40-*, HRSH090-W*-20/40-*	9-12
9.5	Types of hazard labels	9-13
9.5.1	Locations of Hazard Labels	9-14
9.6	Compliance standard	9-15
9.7	Sample DoC	9-16
9.8	Daily Check Sheet	9-17
Chapter 10	Product Warranty	10-1

Chapter 1 Safety Instructions



Before using the product be sure to read and understand all the important actions highlighted in this manual.

1.1 Before using the product

- This chapter is intended to specifically describe the safety related issues for handling the product. Read this before handling the product.
- The product is a cooling device using circulating fluid. SMC does not take any responsibility for any problems that may arise from using the product for other purposes.
- This product is not designed for a clean room. It generates dust from the internal components such as pump and fan motor.
- The product is operated at high voltage and contains components which become hot and rotate. If a component needs to be replaced or repaired, contact a specialized vendor for parts and service.
- All personnel who work with or around the product should read and understand the safety related information in this manual carefully before starting work.
- The safety manager is responsible for strictly observing safety standards, but responsibility in respect to safety standards during daily work resides with each individual operator and maintenance personnel.
- Do not use the materials that rust or corrode for the circulating fluid and facility water circuits. Using the materials that tend to rust or corrode may cause clogs or/and leakages of the circulating fluid and facility water circuits. In case of using these kind of materials, consider and carry out some prevention against the rusting or corrosion by the customer side.
- This manual must be kept available to operators whenever necessary.

1.2 Reading the Manual

This manual contains symbols to help identify important actions when installing, operating or maintaining the product.



This sign indicates actions that must be followed.



This sign indicates prohibited actions.

1.3 Hazards

1.3.1 Level of hazards

The instructions given in this manual aim to assure the safe and correct operation of the product, and to prevent injury of operators or damage to the product. These instructions are grouped into three categories, Danger, Warning and Caution, which indicate the level of hazard, damage and also the degree of emergency. All safety critical information should be carefully observed at all times.

“DANGER”, “WARNING” and “CAUTION” signs are in order according to severity (DANGER> WARNING> CAUTION).

DANGER

“DANGER”: Hazard that **WILL** cause serious personal injury or death during operation.

WARNING

“WARNING”: Hazard that **MAY** cause serious personal injury or death during operation.

CAUTION

“CAUTION”: Hazard that **MAY** cause minor personal injury.

CAUTION

“CAUTION without exclamation symbol”: Hazard that **MAY** cause damage or failure of the product, facility, devices, ect.

1.3.2 Definition of “Serious injury” and “Minor injury”

■ “Serious injury”

This term describes injuries that result in after effects including loss of eyesight, burns, electrical shock, fracture, poisoning, etc. and requires long-term treatment or hospitalization.

■ “Minor injury”

This term describes injuries that do not need long-term treatment or hospitalization. (Others excluded from serious injury.)

1.4 Product Label

Information about the product, such as Serial No. and Model No. can be found on the model label. This information is needed when contacting an SMC sales distributor.

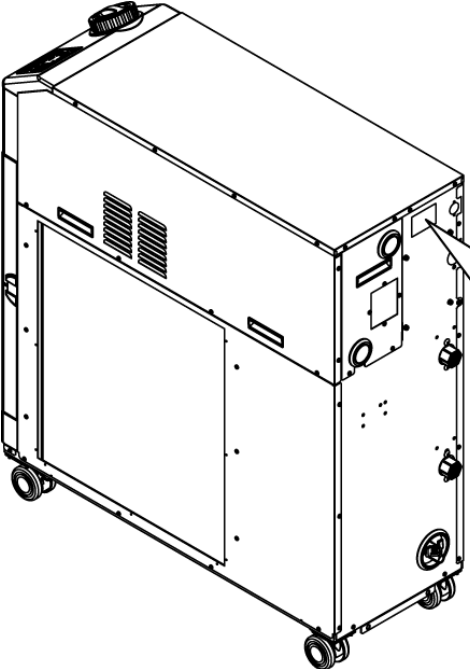

Model number	→	HRSH090-A-20
Serial number	→	THERMO CHILLER SERIAL No. To001 (JAN. 2015)
Kind and amount of refrigerant	→	POWER SUPPLY 3~200/200~230V 50/60Hz 15A CAPACITY (A1C) 10kA REFRIGERANT R410A (HFC) 1.32kg WEIGHT 130 kg (Net Weight) MANUAL HRX-OM-R026, HRX-OM-R026

4-14-1, Sotokanda, Chiyoda-ku,
Tokyo 101-0021, JAPAN
 MADE IN JAPAN 6

* (An example of "HRSH090-A-20" model.)
"3~" stands for "3 inter phase".
(IEC 60417-5032-1)

* In case of option S, the bellow label put near the product label. CE mark is printed in the product label.



How to see the serial number **R y 001** (November 2013)

R			y			001
Year	Symbol	Remarks	Month	Symbol	Remarks	Serial no.
2013	R	Repeated	1	O	Repeated from	---
2014	S	from	2	P	O to Z in alphabetical	
2015	T	A to Z in	3	Q	order, with O for	
↓	↓	alphabetical	↓	↓	January and Z for	
		order			December	

Fig. 1-1 Position of product label

1.5 Safety Measures

1.5.1 Safety Instructions for Use

⚠ WARNING	
	Follow the instructions below when using the product. Failure to follow the instructions may cause an accident and injury.

- Read and understand this manual carefully before using the product.
- Before starting maintenance of the product, be sure to lock out and tag out the breaker of the user's power supply.
- If operating the product during maintenance, be sure to inform all workers nearby.
- Use only the correct tools and procedure when installing or maintaining the product.
- Use personal protective equipment where specified ("1.5.2 Personal Protective Equipment")
- Check all parts and screws are fitted correctly and securely after maintenance.
- Avoid working in a drunken or sick condition, which might cause an accident.
- Do not remove the panels except for the cases permitted in this manual.
- Do not remove the panels during operation.

1.5.2 Personal Protective Equipment

This manual specifies personal protective equipment for each work.

■ Transport, Installing and Uninstalling

⚠ CAUTION	
	Always use safety shoes, gloves and head protection when transporting, installing or uninstalling the product.

■ Handling of circulating fluid

⚠ CAUTION	
	Always use safety shoes, gloves, mask, apron and eye protection when handling the circulating fluid.

■ Operation

⚠ CAUTION	
	Always use safety shoes and gloves when operating the product.

1.6 Emergency Measures

When emergency conditions such as natural disaster, fire and earthquake, or injury occurs, shut off the breaker of the user's power supply that supplies the power to the product.

WARNING



Even when the power supply switch is turned off, some of the internal circuits are still energized, unless the user's power supply is shut off. Be sure to shut off the breaker of the user's power supply.

1.7 Waste disposal

1.7.1 Disposal of refrigerant and compressor oil

The product uses hydro fluorocarbon type refrigerant (HFC) and compressor oil. Comply with the laws and regulations in each country for the disposal of refrigerant and compressor oil. The type and quantity of refrigerant is described on the 1.4 Product Label.

If these fluids need to be recovered, read and understand the instructions below carefully. If there is any unclear point, contact an SMC's sales distributor.

WARNING



- Only maintenance personnel or qualified people are allowed to open the cover panels of the product.
- Do not mix the compressor oil with domestic waste for disposal. Also, the disposal of the waste must only be conducted by specific facilities that are permitted for that purpose.

WARNING



- Comply with the laws and regulations in each country for the disposal of refrigerant and compressor oil.
- The release of refrigerant in to the atmosphere is banned by law. Recover it with specific equipment and dispose of it correctly.
- Only people who have sufficient knowledge and experience about the product and its accessories are allowed to recover the refrigerant and compressor oil.

1.7.2 Disposal of product

The disposal of the product must be handled by a specialized industrial waste disposal agency in accordance with local laws and regulations.

1.8 Material Safety Data Sheet (MSDS)

If the material safety data sheets of chemicals used in this product are needed, contact an SMC's sales distributor.

Any chemicals used by the user must be accompanied by an MSDS.

Chapter 2 Name and Function of Parts

2.1 Model number of product

The product can be ordered with the model number configured as shown below.

The product needs to be handled in different ways depending on the part number. Refer to “1.4 Product Label” and check the part number of the product.

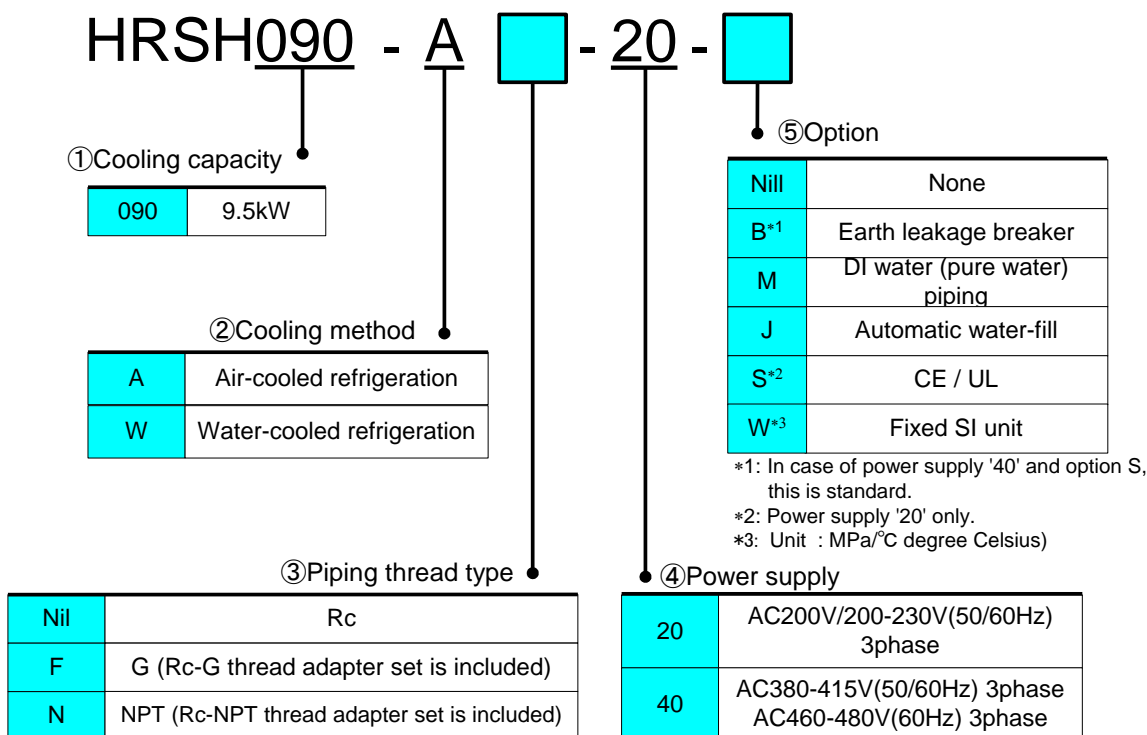

Fig. 2-1 Model number of product

2.2 Name and Function of Parts

2.2.1 HRSH090-A*-20/40-*(In case of air cooled type)

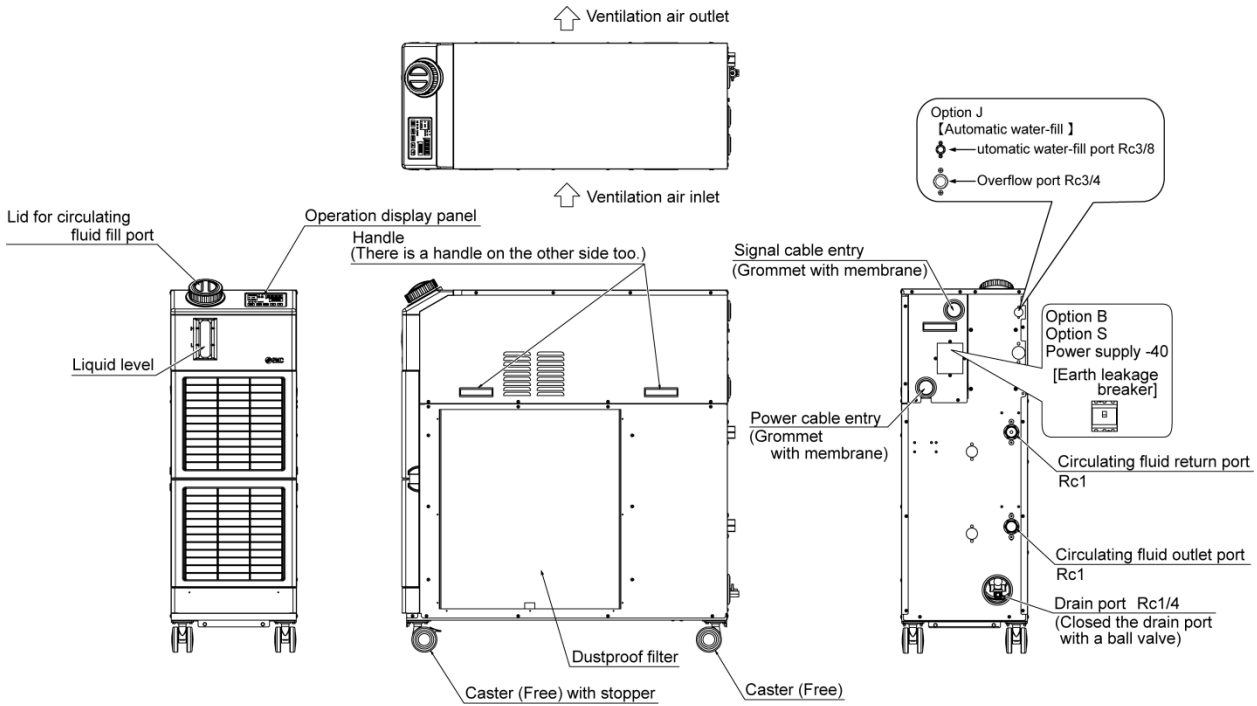





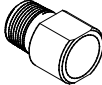

Fig. 2-2 Names of each part

Table 2-1 Accessory list

1	Alarm cord list label	2pcs. (English 1pc./Japanese 1pc.)	
2	Operation manual	2pcs. (English 1pc./Japanese 1pc.)	
3	Y strainer (40meshes) 25A	1pc.	
4	Barrel nipple 25A	1pc.	
5	Anchor brackets ※The anchor bolts are not attached	2pc.	
6	For HRSH090-AF-*-* G thread adapter set (HRS-EP019)	1set	
	For HRSH090-AN-*-* NPT thread adapter set (HRS-EP018)	1set	
	For HRSH090-AF-*-*J G thread adapter set (HRS-EP021)	1set	
	For HRSH090-AN-*-*J NPT thread adapter set (HRS-EP020)	1set	

2.2.2 HRSH090-W*-20/40-*(In case of water cooled type)

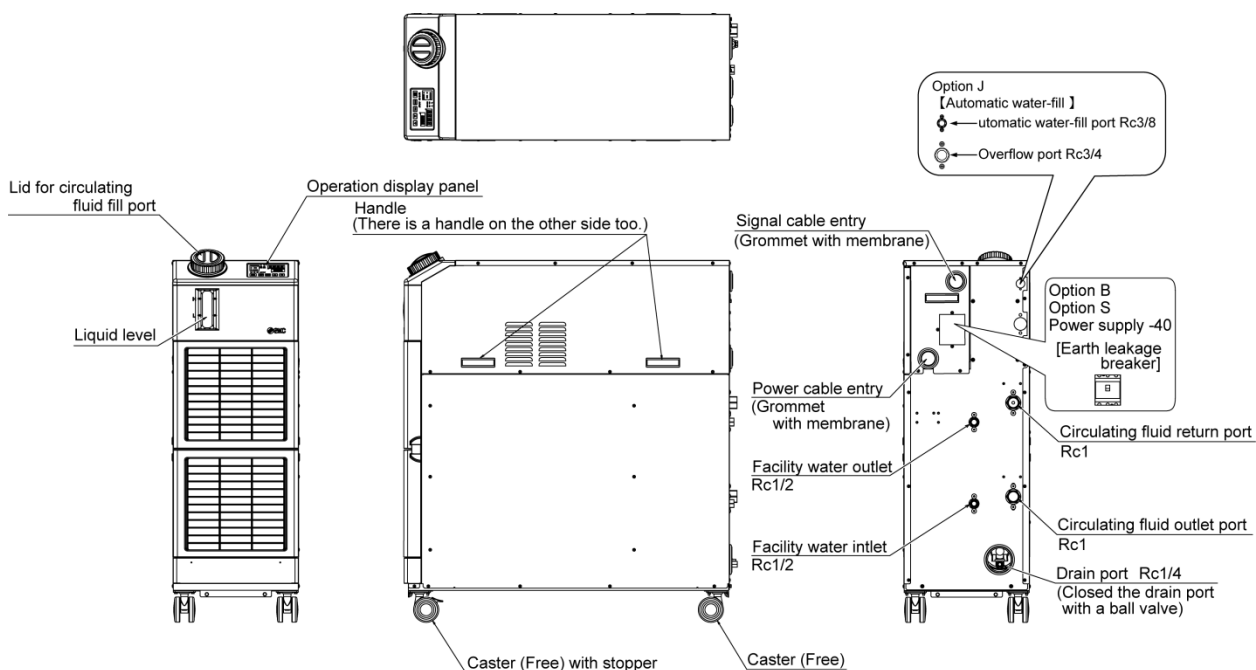



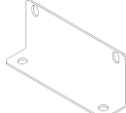
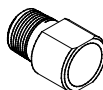

Fig. 2-3 Names of each part

Table 2-2 Accessory list

1	Alarm cord list label	2pcs. (English 1pc./Japanese 1pc.)	
2	Operation manual	2pcs. (English 1pc./Japanese 1pc.)	
3	Y strainer (40meshes) 25A	1pc.	
4	Barrel nipple 25A	1pc.	
5	Anchor brackets ※The anchor bolts are not attached	2pc.	
6	For HRSH090-WF-*** G thread adapter set (HRS-EP023)	1set	
	For HRSH090-WN-*** NPT thread adapter set (HRS-EP022)	1set	
	For HRSH090-WF-**-J G thread adapter set (HRS-EP025)	1set	
	For HRSH090-WN-**-J NPT thread adapter set (HRS-EP024)	1set	

2.3 Function of Parts

The function of parts is as follows.

Table 2-3 Function of parts

Name	Function
Operation display panel	Runs and stops the product and performs settings such as the circulating fluid temperature. For details, refer to "2.4 Operation display panel".
Fluid level gauge	Indicates the circulating fluid level of the tank. For details, refer to "3.5 Fill of circulating fluid".
Model label	Shows the product information such as model number and serial number. For details, refer to "1.4 Product Label".
Circulating fluid outlet port	The circulating fluid flows out from the outlet port.
Circulating fluid return port	The circulating fluid returns to the return port.
Tank drain port	This drain port to drain the circulating fluid out of the tank.
Automatic fluid fill port	Piping to the automatic fluid filling port enables easy supply of the circulating fluid through the ball tap in the reservoir. The supply pressure should be within the range of 0.2 to 0.5MPa.
Overflow port	Be sure to connect piping from this port to sump pit to discharge the excess circulating fluid that caused by fluid level rising.
Dust-proof filter	Inserted to prevent that the dust and contamination are clung on the air cooled condensers directly. For details, refer to "8.2.2 Monthly check".
Power cable entry	Insert the power cable to the power cable entry and connect it to the power terminal. For details, refer to "3.3.2 Electrical wiring" and "3.3.3 Preparation and wiring of power supply cable".
Power terminal	
Signal cable entry	Insert the signal cable to the signal cable entry and connect it to the signal connectors. For details, refer to "3.3.4 Contact input/output communication wiring", "3.3.6 Wiring of Run/stop signal input·Remote signal input", "3.3.8 Wiring of external switch signal input", "3.3.9 Wiring of operation signal output and alarm signal output", "3.3.8 RS-485 Communication wiring", "3.3.9 RS-232C Communication wiring or the Operation manual Communication function.
Signal connectors	
Earth leakage breaker (When option B [Earth leakage breaker] is selected.)	Shuts off the power supply to the internal equipment of product. (Parts energized remained in the product) Refer to "3.3.2 Electrical wiring" for the earth leakage breaker.
Facility water inlet port	Supply facility water to inlet port.
Facility water outlet port	Facility water out from outlet port and return to customer's facility water system.
Automatic water-fill port (When automatic fluid filling [Option J] is selected.)	Piping to the automatic fluid filling port enables easy supply of the circulating fluid through the built-in solenoid valve. The supply pressure should be in a range of 0.2 to 0.5MPa.
Overflow port (When automatic fluid filling [Option J] is selected.)	This is necessary when automatic fluid filling function. Discharge excess circulating fluid when the fluid level in the tank rises.

2.4 Operation display panel

The operation panel on the front of the product controls the basic operation of the product.

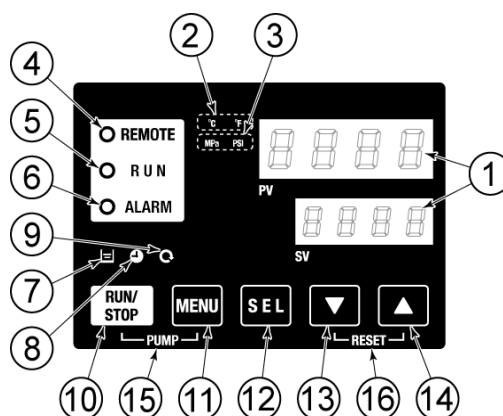

Fig. 2-4 Operation display panel

Table 2-4 Operation display panel

No	Description	Function		Reference page
①	Digital display (7 segment, 4 digits)	PV	Displays the temperature and pressure of the circulating fluid and alarm codes.	5.3
		SV	Displays the set temperature of the circulating fluid and the set values of other menus.	
②	[°C °F] lamp	Displays the unit of display temperature (°C or °F).		5.13
③	[MPa PSI] lamp	Displays the unit of display pressure (MPa or PSI).		5.14
④	[REMOTE] lamp	Lights up during remote operation by communication.		5.21
⑤	[RUN] lamp	<ul style="list-style-type: none"> • Lights up when the product is started and in operation. Goes off when the product is stopped. • Blinks during stand-by for stop (Interval 0.5 seconds). • Blinks during independent operation of the pump (Interval 0.3 seconds). • Blinks during anti-freezing function (At standby: Interval 2 seconds, At operation: Interval 0.3 seconds). • Blinks during warming up function (At standby: lit on for 0.5 seconds and off for 3 seconds, At operation: interval 0.3 seconds.) 		4.4
⑥	[ALARM] lamp	Flashes with buzzer when alarm occurs (Interval 0.3 seconds).		5.4
⑦	[] lamp	Lights up when the fluid level lowers.		4.3
⑧	[] lamp	Lights up while the run timer or stop timer function is working.		5.7
⑨	[] lamp	Lights up when the product is in automatic operation.		5.10
⑩	[RUN/STOP] key	Makes the product start or stop.		4.4
⑪	[MENU] key	Shifts the main menu (display screen of temperature) the other menu (entry of set values and monitor screen).		5.2
⑫	[SEL] key	Changes the item in menu and enters the set value.		
⑬	[▼] key	Decreases the set value.		-
⑭	[▲] key	Increases the set value.		
⑮	[PUMP] key	When the [MENU] and [RUN/STOP] keys are held down simultaneously, the pump starts running independently.		4.3
⑯	[RESET] key	Press the [▼] and [▲] keys simultaneously. This will stop the alarm buzzer and reset the [ALARM] lamp.		7.3
		Keep the [▼] and [▲] keys pressed down simultaneously for 3 seconds to reset AL46 and AL48. (After resetting AL48, WAIT (H R I E) will be displayed and the product cannot run for 40 seconds. Restart 40 seconds later after resetting.)		

Chapter 3 Transport and Setting Up

⚠ WARNING



- Only persons who have sufficient knowledge and experience about the product and system are allowed to transport and set up the product.
- Especially pay attention to personal safety.

3.1 Transport

The product is heavy and has potential danger at transport. Also, to prevent damage and breakage of the product, be sure to follow these instructions for transport.

⚠ WARNING



- When moving the product by a forklift, insert the fork into the right positions referring to 3.1.1 Moving by forklift.
- Moving by forklift should be done by persons who have the licenses.

CAUTION



Never lay the product on its side.
The compressor oil will leak in to the refrigerant piping, which may cause early failure of the compressor.

CAUTION



- Drain the residual fluid from the piping as much as possible to prevent any spillage.

CAUTION



- When the product is carried by using a forklift, make sure that the fork does not damage the cover panel, piping port, or caster.
- Do not manipulate the fork in the range outside the label at the bottom of the side surface of the product.

3.1.1 Moving by forklift

⚠ **WARNING**



- The product are heavy object. (Refer to Table 3-1 Weight of the product)
- Moving by forklift should be done by persons who have the licenses.

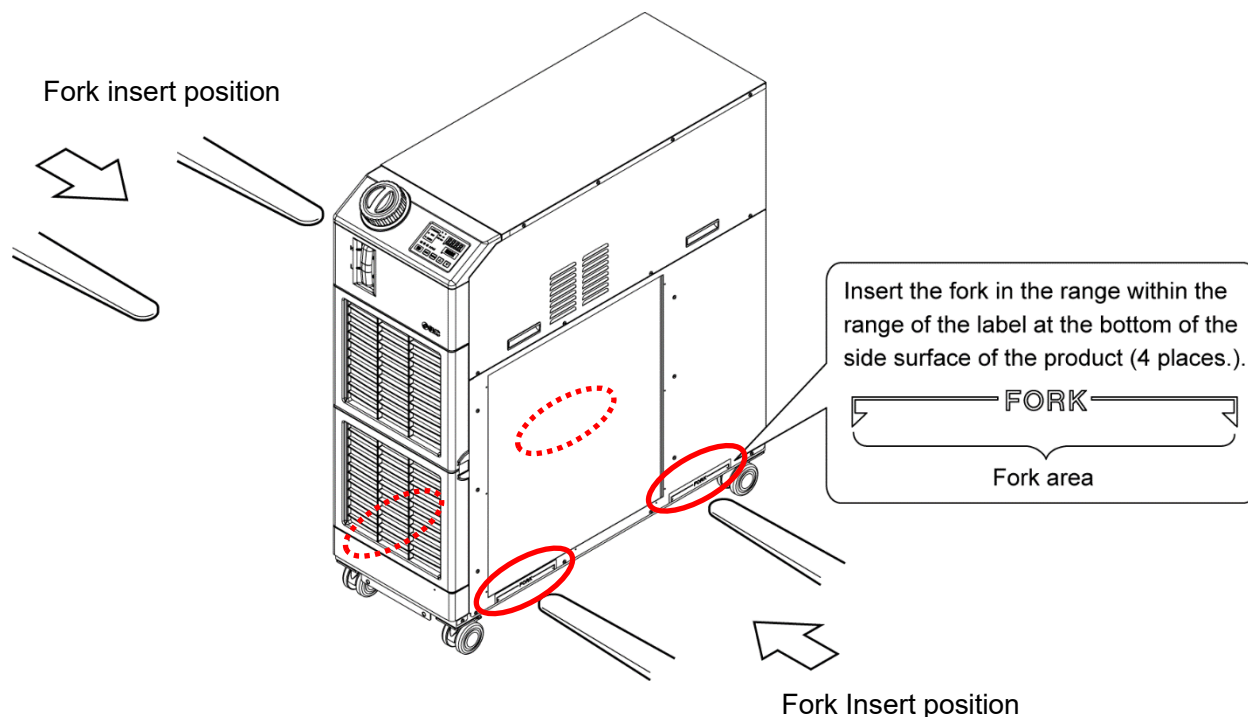



Fig 3-1 Fork insert and slinging position)

Table 3-1 Weight of the product

Model	Weight kg
HRSH090-A*-**	Approx. 130
HRSH090-W*-**	Approx. 121

3.1.2 Moving by casters

⚠ WARNING



- The product are heavy object. (Refer to Table 3-1 Weight of the product).
- Moving the product by casters should be done by 2 persons or more.

CAUTION



- Release the lock lever of the front casters and push the corner of the product. Do not grip the piping or the handles of the panel. The piping or panel may be damaged.
- Do not hold the product by the cap to move it. This will apply excess force to the piping of internal parts which may lead to malfunctions such as fluid leakage.
- Remove the anchor bolt fixtures.

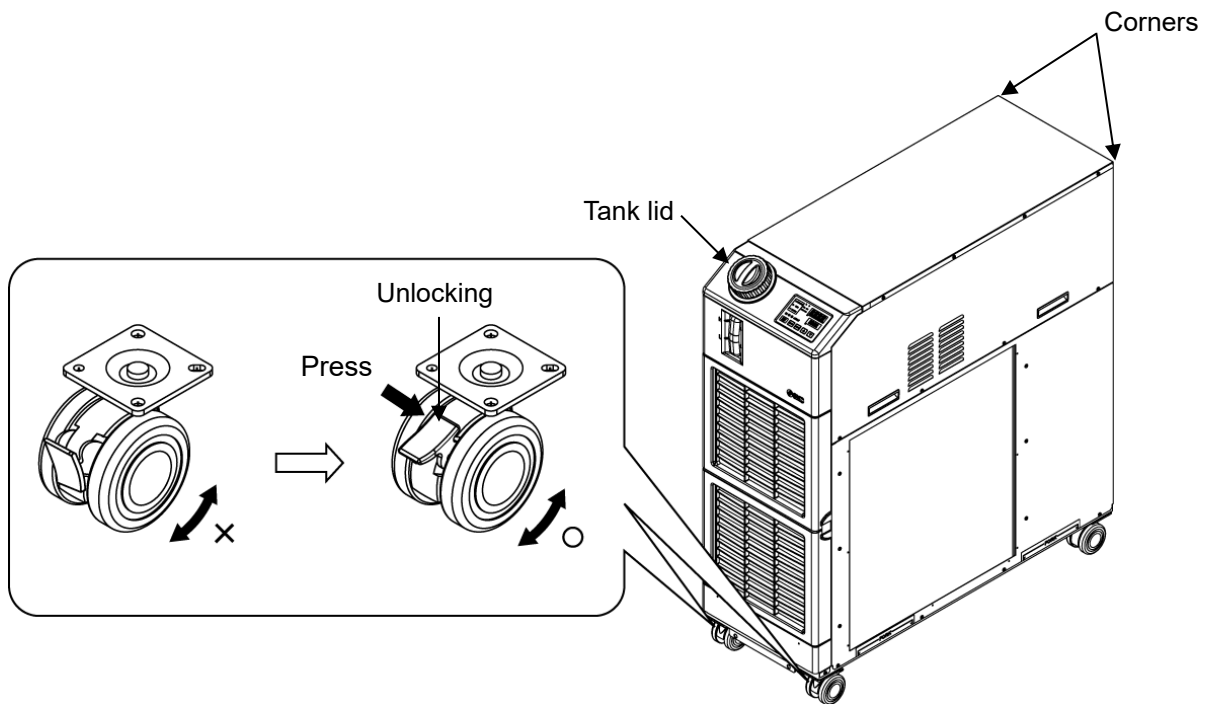



Fig. 3-2 Transportation using casters

3.2 Installation

⚠ WARNING



- Do not set up the product in places possibly exposed to leakage of flammable gas. Should any flammable gas stay around the product, the product may cause a fire.
- Do not use the product outdoors. If the product subjected to rain or water splash it may cause electrical shock, fire or failure.

⚠ CAUTION



- Keep the product horizontal to a rigid and flat floor which can resist the weight of the product, and take measures to prevent the product from tipping over. Improper installation may cause water leakage, tipping, damage of the product or injure the operator.
- Keep the ambient temperature of the product between 5 to 45°C. Operation out of this ambient temperature range may cause a malfunction of the product.
- The installer/end user is responsible for carrying out a acoustic noise risk assessment on the equipment after installation and taking appropriate measures as required.

3.2.1 Environment

The product must not be operated, installed, stored or transported in the following conditions. Potential malfunction or damage to the product may occur if these instructions are disregarded.

The product does not conform to any clean room specifications. The pump and ventilating fan inside the product generate particles.

- In a location that is exposed to water, water vapor, steam, salt water or oil.
- Location that is exposed to dust or powder material.
- Location that is exposed to corrosive gas, organic solvent, chemical solution, or flammable gas (the product is not explosion-proof)
- Location where the ambient temperature is out of the following range:
 In transportation and In storage 0 to 50°C
 (Should not be water or circulating fluid circuit in the product)
 In operation 5 to 45°C (Use 15% ethylene glycol aqueous solution if operating in a place where the circulating fluid temp. or ambient temperature is lower than 10 °C.)
- Location where condensation forms on the inside electrical parts.
- Location that is exposed to direct sunlight or heat radiation.
- Location that is near heat sources and poor in ventilation.
- Location that is subjected to abrupt changes in temperature.
- Location that is subjected to strong electromagnetic noise (intense electric field, intense magnetic field, or surges).
- Location that is subjected to static electricity, or conditions where static electricity can discharge to the product.
- Location that is subjected to strong high frequencies raditation (microwaves).
- Location that is subjected to potential lightning strrike.

- Location at altitude of 3000m or higher (except during product storage and transport).

*Because of lower air density, the heat radiation efficiencies of the devices in the product will be lower in the location at altitude of 1000m or higher. Therefore, the maximum ambient temperature to use and the cooling capacity will lower according to the descriptions in the table below. Please select the thermo chiller considering the descriptions.

1. Max. ambient temp.: Use the product in lower ambient temperature than the described value at each altitude.
2. Cooling capacity coefficient: The product's cooling capacity will lower to one that multiplied by the described value at each altitude.

Altitude [m]	1. Max. ambient temp. [°C]	2. Cooling capacity coefficient
Less than 1000m	45	1.00
Less than 1500m	42	0.85
Less than 2000m	38	0.80
Less than 2500m	35	0.75
Less than 3000m	32	0.70

- Bevelled place.
- Location where the product is affected by strong vibrations or impacts.
- Condition that applies external force or weight causing the product to be damaged.
- Location without adequate space for maintenance as required.
- Location that is outside.

3.2.2 Location

CAUTION

- Do not install in a location which can be subjected to any of the conditions in 3.2.1 Environment.

CAUTION

The air cooled product radiates heat from the air vent of the cooling fan. If the product is operated with insufficient air ventilation the internal temperature can exceed 45°C*, which can cause an affect the performance and life of the product. To prevent this ensure that suitable ventilation is available (see below).

■ **Installation of multiple products**

Keep sufficient space between products so that the air vented from one product will not be taken in by other products.

■ **Installation at indoor site**

1. In case of facility having a large installation area (that can vent the air naturally)
Make an air outlet on a wall at a high level and air inlet on a wall at a low level, to allow for adequate airflow.
2. In case of facility having a small installation area (that can not vent the air naturally)
Make a forced air exhaust vent on a wall at a high level and an air inlet on a wall at a low level.
3. Using duct to exhaust the air
In case the indoor site cannot accept the exhausted air from the product or/and is air conditioned, ventilate by installing a duct on the outlet ventilation of the product. Do not fasten the duct on the outlet ventilation of the product directly. Have the space at least the dust's diameter apart. Use a fan for the duct that considered the ventilation resistance of the duct.

Table 3-2 Amount of radiation and required ventilation

Model	Heat radiation kW	Required ventilation amount m ³ /min	
		Differential temp. of 3 °C between inside and outside of installation area	Differential temp. of 6 °C between inside and outside of installation area
HRSH090-A***-	Approx.18	305	155

CAUTION

The water cooled product radiates heat to the facility water. It is necessary to supply the facility water. Please prepare the facility water system that satisfies the heat radiation and the facility water specifications below.

■ **Required facility water system**

Table 3-3 Heat radiation

Model	Heat radiation kW	Facility water specifications
HRSH090-W*-20/40-*	Approx. 20	Refer to [9.1 Specifications].

3.2.3 Installation and Maintenance Space

It is recommended to keep the space around the product shown in Fig. 3-3.

⚠ CAUTION

! Have an enough space for the ventilation for the product. Otherwise it may cause a lack of cooling capacity or/and stoppage of the product. Have an enough space for maintenance.

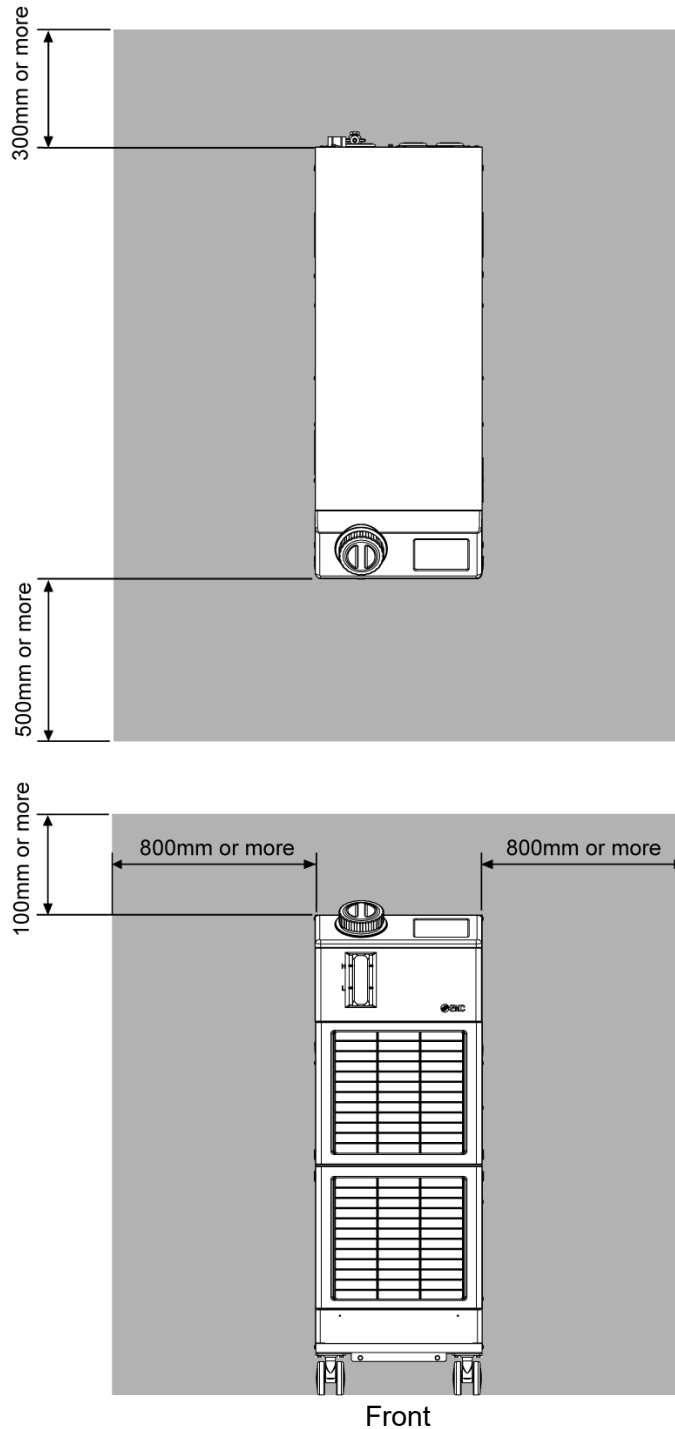

Fig. 3-3 Installation space

3.3 Installation

3.3.1 Installation

⚠ CAUTION



Install the product on the horizontal floor. Prepare the M10 anchor bolts that are appropriate to the material of the floor that the product will be installed. Drive the anchor bolts at least at two places of the left and right side of the product each (totally four places). Refer to the “8.2 Outline dimensions” for the dimensions for the position of the anchor bolts.

■ How to mount the product

1. Move the product to the installation area.
2. After moving, lock the front casters again.

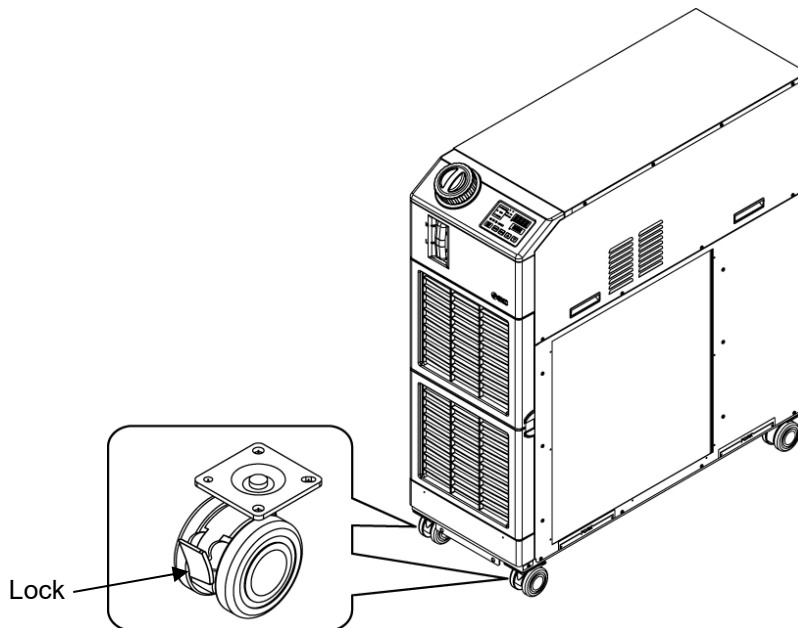

Fig. 3-4 Installation procedures

■ Fixture

Use the fixtures and holding screws (for holding the product) fixed to the wooden box at the bottom of the product to fix the product to the floor using anchor bolts.

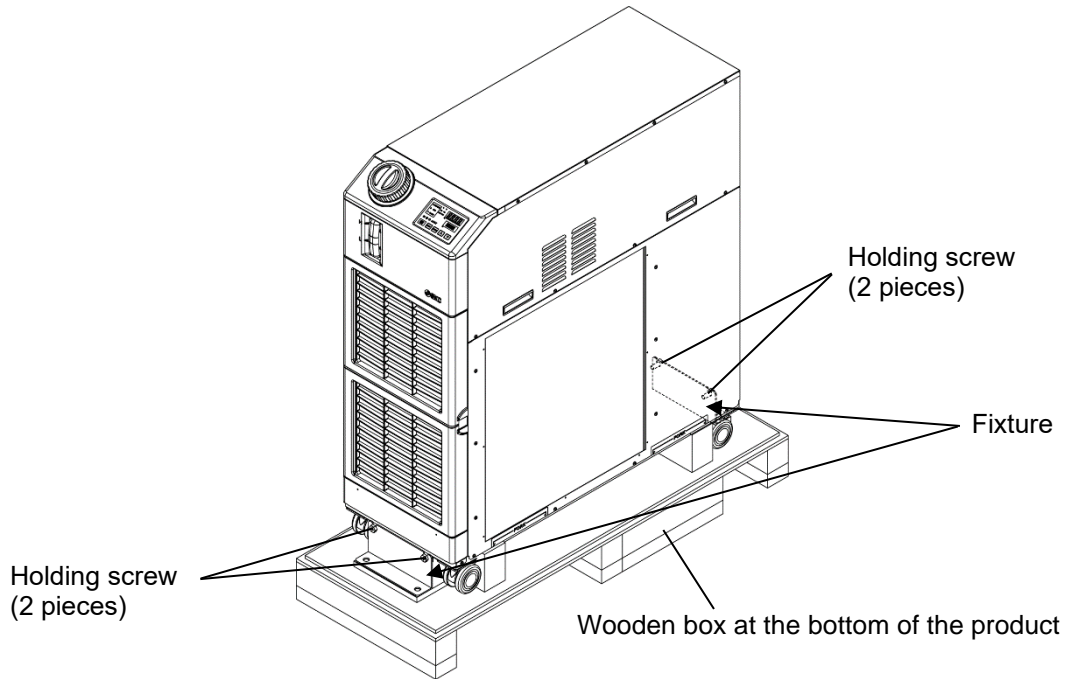

Fig. 3-5 Fixtures and holding screws

1. Install anchor bolts on the levelled floor with dimensions below.

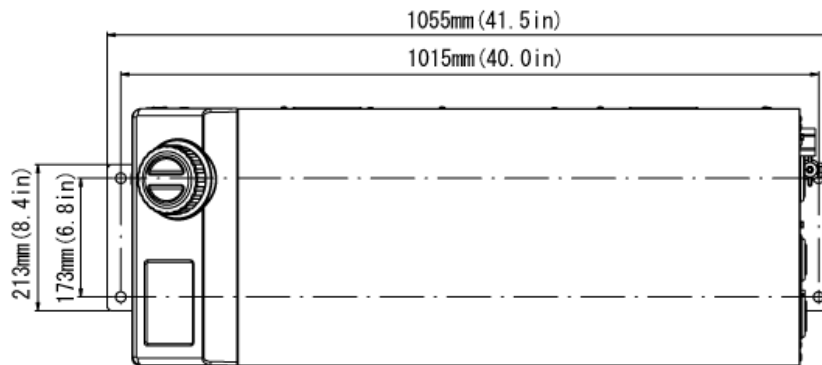

Fig. 3-6 Installation of anchor bolts

2. Set the fixture from the top of the anchor bolts.

- 3.** Set hexagon screws to the anchor bolts and screw the holding screws into the product to settle the product to the floor. Fixture is mounted to the front and the rear surface of the product. (2 places)

[Tips]

SMC Foundations bolt set [IDF-AB500] (SUS M10x50mm) is applicable.

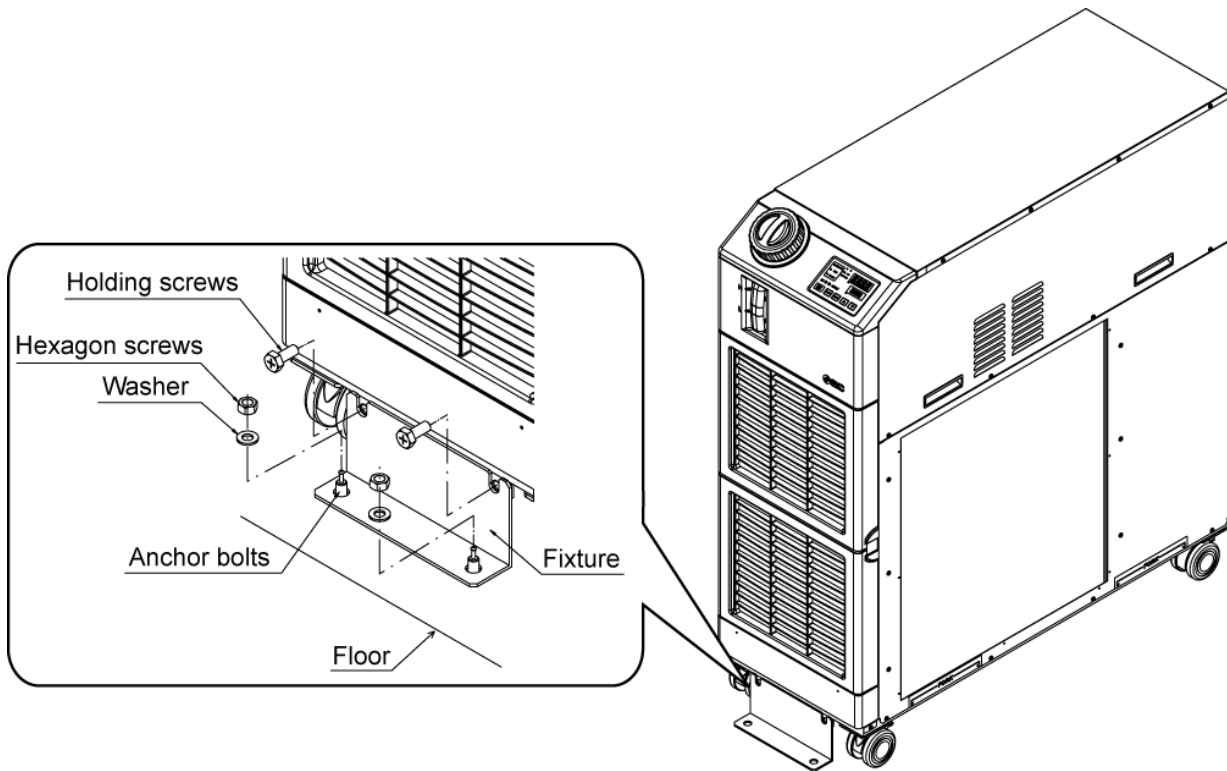

Fig. 3-7 Settlement to the floor

3.3.2 Electrical wiring

⚠ WARNING



- Do not modify the internal electrical wiring of the product. Incorrect wiring may cause electrical shock or fire. Also, modifying the internal wiring will void the product's warranty.
- Do not connect the ground to water line, gas pipe or lightning conductor.

⚠ WARNING



- Only qualified persons are allowed to wire the product.
- Be sure to shut off the user's power supply. Wiring with the product energized is strictly prohibited.
- The wiring must be conducted using cables complying with "Table 3-4" firmly and secured to the product to prevent the external force of cables being applied to the terminals. Incomplete wiring or improper securing of wiring may cause electrical shock, excessive heat and fire.
- Ensure a stable power supply with no voltage surges.
- Ensure that an Earth Leakage Breaker is used in the power supply of the product. See "Table 3-4".
- Use a power supply suitable for the specifications of the product. Be sure to connect the ground connection.
- Ensure that a lock out facility is available on the power supply.
- Each product must have its own separate Earth Leakage Breaker. Otherwise there can be a risk of electric shock or fire.
- Ensure that no harmonics are superimposed at power supply. (Do not use inverter etc.)
- Supply a steady power supply which is not affected by surges or distortion. In particular, if the voltage rate of increase (dv/dt) at zero crossing exceeds $40V/200\mu\text{sec}$, it may cause malfunction.

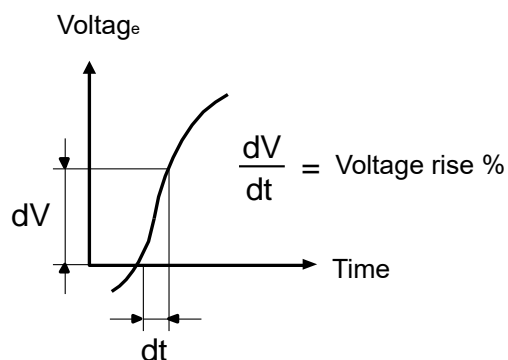

■ Power supply cable and Earth Leakage Breaker

Prepare the power supply shown in the following table. For the connection between the product and power supply, use the power supply cable and earth leakage breaker shown below.

Table 3-4 Power supply cable and Earth Leakage Breaker(Recommended)

Model	Power supply voltage	Terminal block screw diameter	Recommended crimp terminal	Cable qty. x size*2	Earth leakage breaker *1	
					Rated current [A]	Sensitivity of leak current [mA]
HRSH090-A*-20-* HRSH090-W*-20-*	AC200/ 200-230V 50/60Hz 3phase	M5	R5.5-5	4 cores x AWG10 (4 cores x 5.5mm ²) *including ground	30	30
HRSH090-A*-40-* HRSH090-W*-40-*	AC380-415V 50/60Hz 3phase AC460-480V 60Hz 3phase		R5.5-5 (Power supply) R14-5 (Grounding cable)	3 x 5.5 mm ² (3 x AWG10) (Power supply) 1 x 14 mm ² (1 x AWG6) (Grounding cable)	20	

*1: A specified earth leakage breaker is installed for option B [Earth leakage breaker] or option S [CE/UL] of each model.

If the product is not option B [Earth leakage breaker] or option S [CE/UL], please prepare an earth leakage breaker by the customer side.

A specified earth leakage breaker is installed for HRSH090- *-40-*.

*2: Please select the proper size of cable according to an actual condition.

3.3.3 Preparation and wiring of power supply cable

⚠ WARNING

- The electrical facilities should be installed and wired in accordance with local laws and regulations of each country and by a person who has knowledge and experience.
- Check the power supply. Operation with voltages, capacities and frequencies other than the specified values can cause fire and electrical shock.
- Wire with an applicable cable size and terminal. Forcibly mounting with an unsuitable size cable may result in heat generation or fire.

⚠ WARNING



Be sure to lock out and tag out the breaker of the facility power supply (customer power supply facility) before wiring.

⚠ WARNING



Be sure to connect the power supply cable from the product side first, and then connect the breaker of the facility power supply (the user's machine power supply).

⚠ CAUTION



- When the panel is removed or mouted, be sure to wear protective shoes and gloves to prevent injury with the edge of the panel.

■ In case of option B, option S and HRSH090- **-40-*

CAUTION

A breaker that has the operating characteristic below is installed. Please use a breaker that has the same or longer operating time as/than this for the customer side (primary side). If it is a shorter operating time, there is a possibility of accidental breaker trip due to the internal motors' inrush currents of this product.

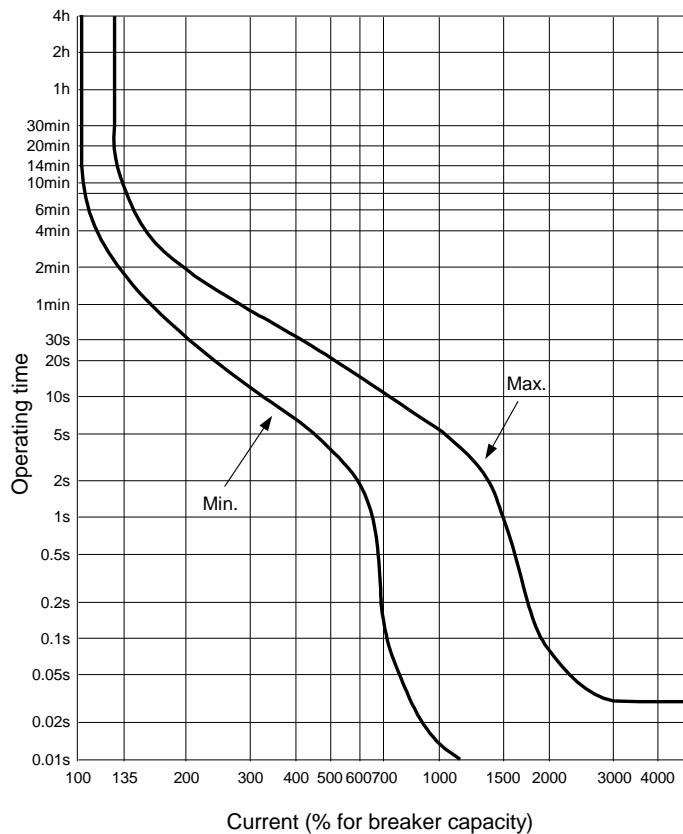

Breaker's operating characteristic

■ Preparation for operation

1. Remove 4 screws to remove the power supply terminal cover on the back of the product.

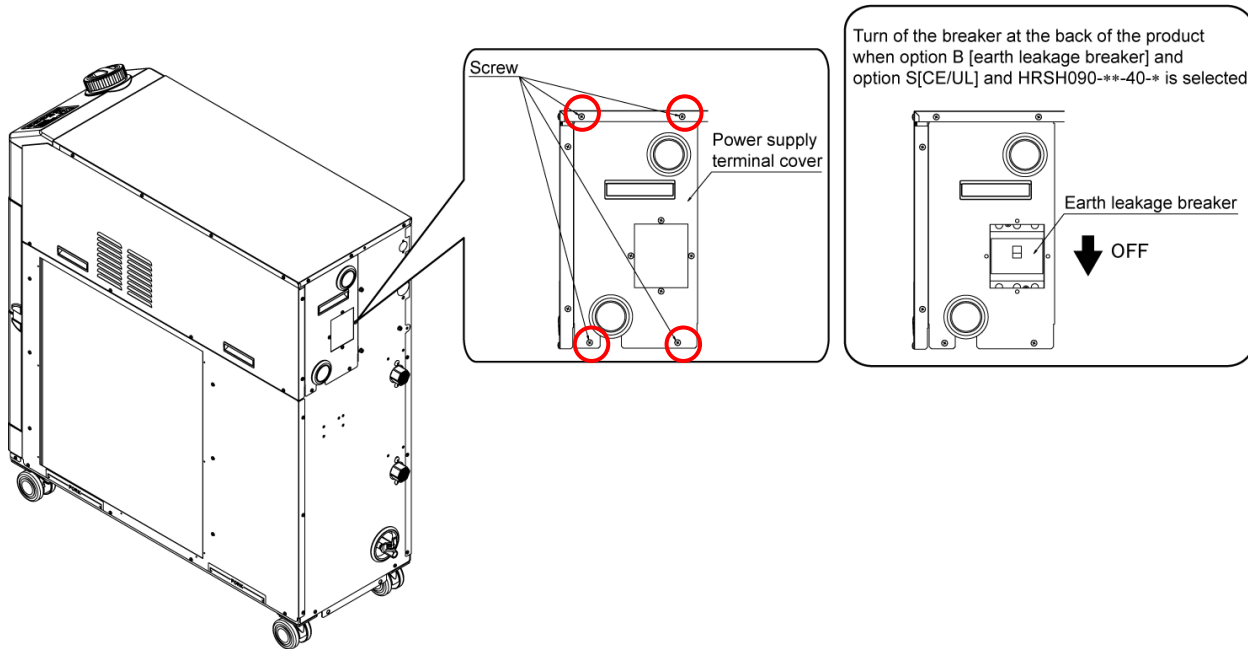

Fig. 3-8 Removal of power supply terminal cover

2. Hold the pull of the power supply terminal cover. Pull the bottom of the cover forward and remove it moving the cover downwards.

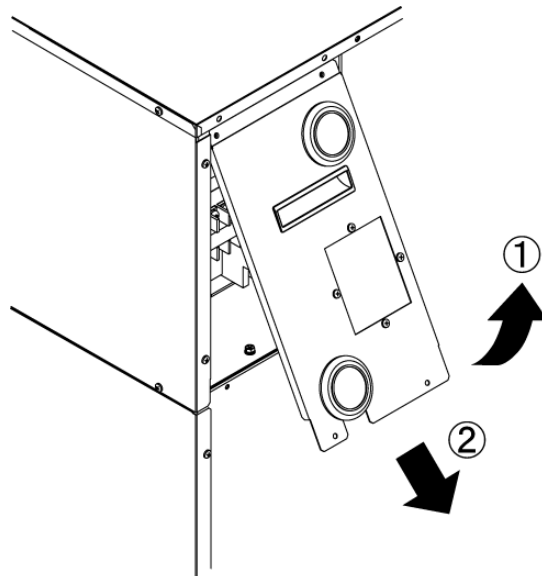

Fig. 3-9 Removal of power supply terminal cover

3. Insert the power supply cable and ground cable to the power supply cable entry of the power supply terminal cover (grommet with film).

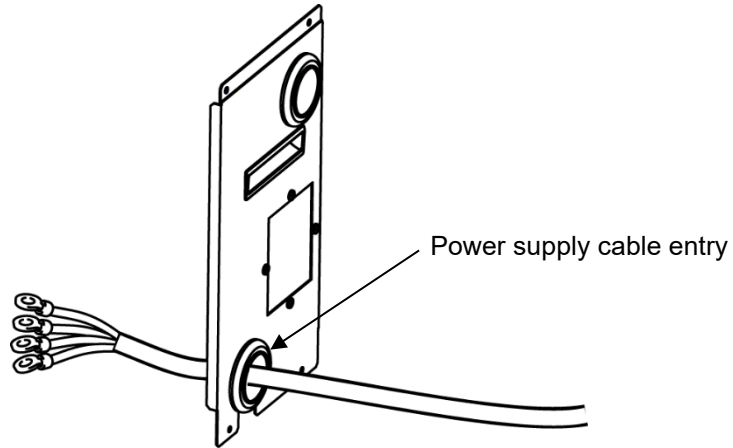

Fig. 3-10 Cable entry

4. Connect the power supply and the ground cable as shown in the figure below.

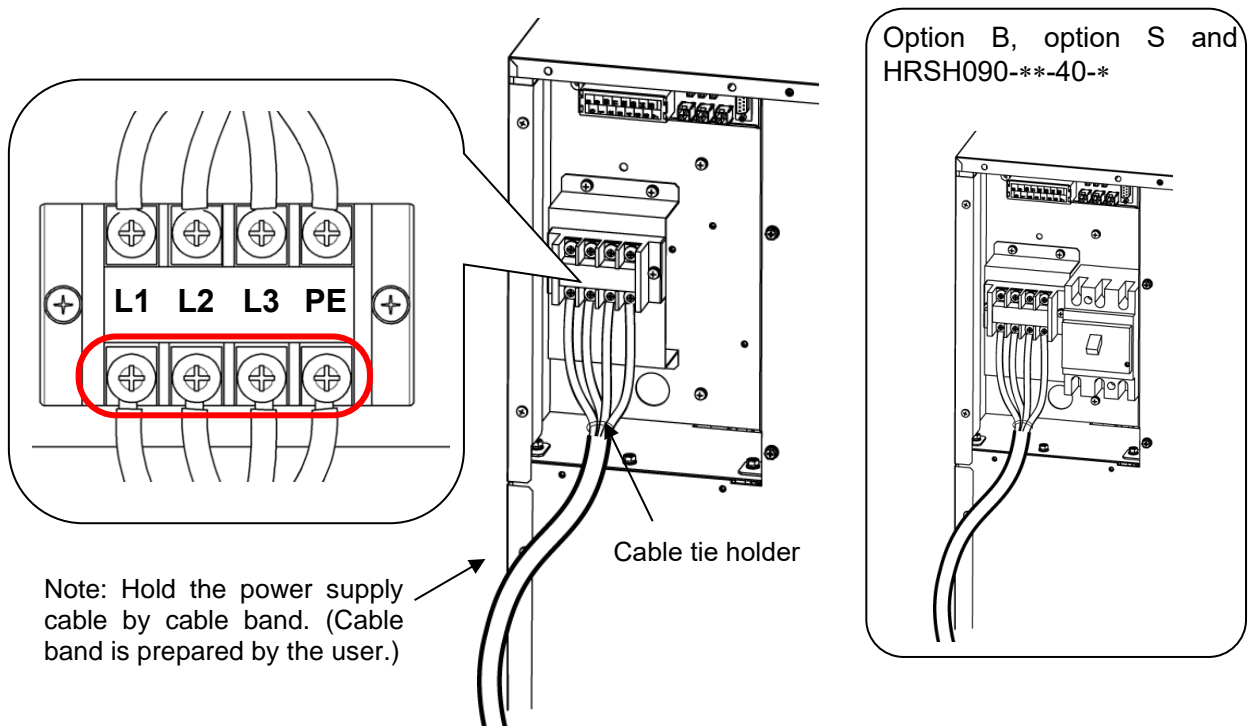

Fig. 3-11 Wiring of power supply cable

- 5.** Mount the power supply terminal cover using 4 screws.

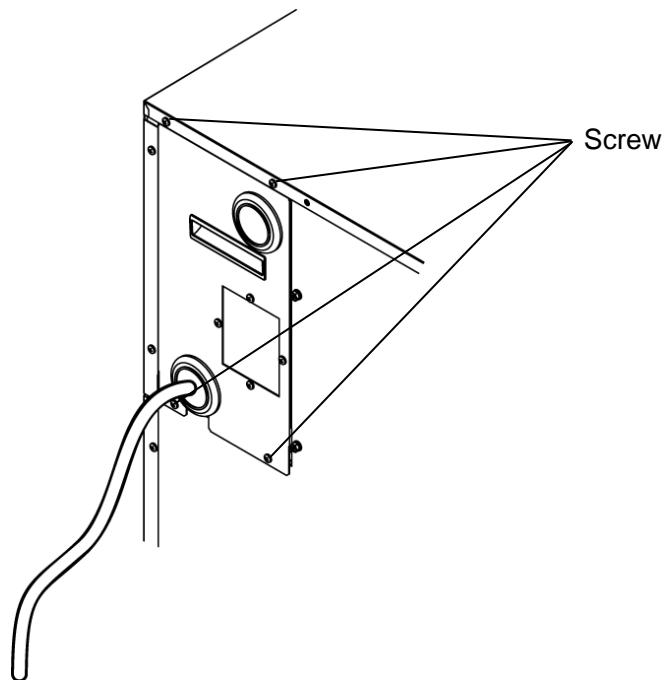

Fig. 3-12 Mounting of power supply terminal cover

3.3.4 Contact input/output communication wiring

⚠ WARNING



Be sure to lock out and tag out the breaker of the facility power supply (customer power supply facility) before wiring.

CAUTION

The capacity of the output contact of the product is limited. If the capacity is not large enough, install a relay, etc. (to allow for larger capacity). At the same time, ensure the input current of the relay is small enough in relation to the contact capacity of the product.

The product has contact input/output communication that has the functions that described below. Wire referring to each function's chapter. (For the details of the functions, refer to the operation manual communication function.)

- Run/stop input·Remote signal input (Refer to 3.3.5 Wiring of Run/stop input·Remote signal input.)
- External switch signal input (Refer to 3.3.6 Wiring of external switch signal input.)
- Output of contact output signal (Refer to 3.3.7 Wiring of contact output signal.)

Use the signal cable described below for wiring of each function.

■ Signal cable

Use the cable and terminals as follows below for wiring of each function.

Table 3-5 Signal cable

Terminal specification		Cable specification
Terminal block screw diameter	Crimp terminal	
M3	1.25Y-3	0.75 mm ² (AWG18) Shielded cable

3.3.5 Wiring of Run/stop signal input·Remote signal input

Run/stop signal input·Remote signal input enable the product to be run and stopped or switched DIO REMOTE and DIO LOCAL remotely by applying a contact signal input. This chapter explains examples of wiring.

Select DIO mode as the communication mode to activate the Run/stop signal input·remote signal input after wiring referring to the operation manual communications function.

[Tips]

This product has two input signals. These can be customized depending on the customer's application.

Table 3-6 Power supply, contact specifications

Name	Terminal NO.	Specification	
Power supply output	5, 6, 7 (DC 24V)	DC 24V ±10% 500mA MAX*1	
	13,14, 15 (24V COM)		
Contact input signal 1	3 (Contact input signal 1)	-Run/stop signal input	Switch the input on the operation display panel. Refer to the operation manual communication function.
	11 (Common of contact output signal 1)	-External switch signal input*2	
Contact input signal 2	4 (Contact input signal 2)	-Run/stop signal input	
	12 (Common of contact output signal 2)	-Remote signal input -External switch signal input*2	

*1: To use the power of the device, the total load current must be 500mA or less.
 If the load is 500mA or more, the internal fuse will be cut to protect the product and the alarm [AL21 DC line fuse cut] will be generated. Refer to Chapter 6 for handling of alarms.
 *2: Refer to 3.3.6 Wiring of external switch signal input.

- 1.** Prepare the switch (source voltage: 24V, contact capacity: 35mA or more, min. load current: 5mA), and cable (Table 3-5 Signal cable).

2. Connect the signal cable and switch to the terminal as follows. (This wiring is an example.)

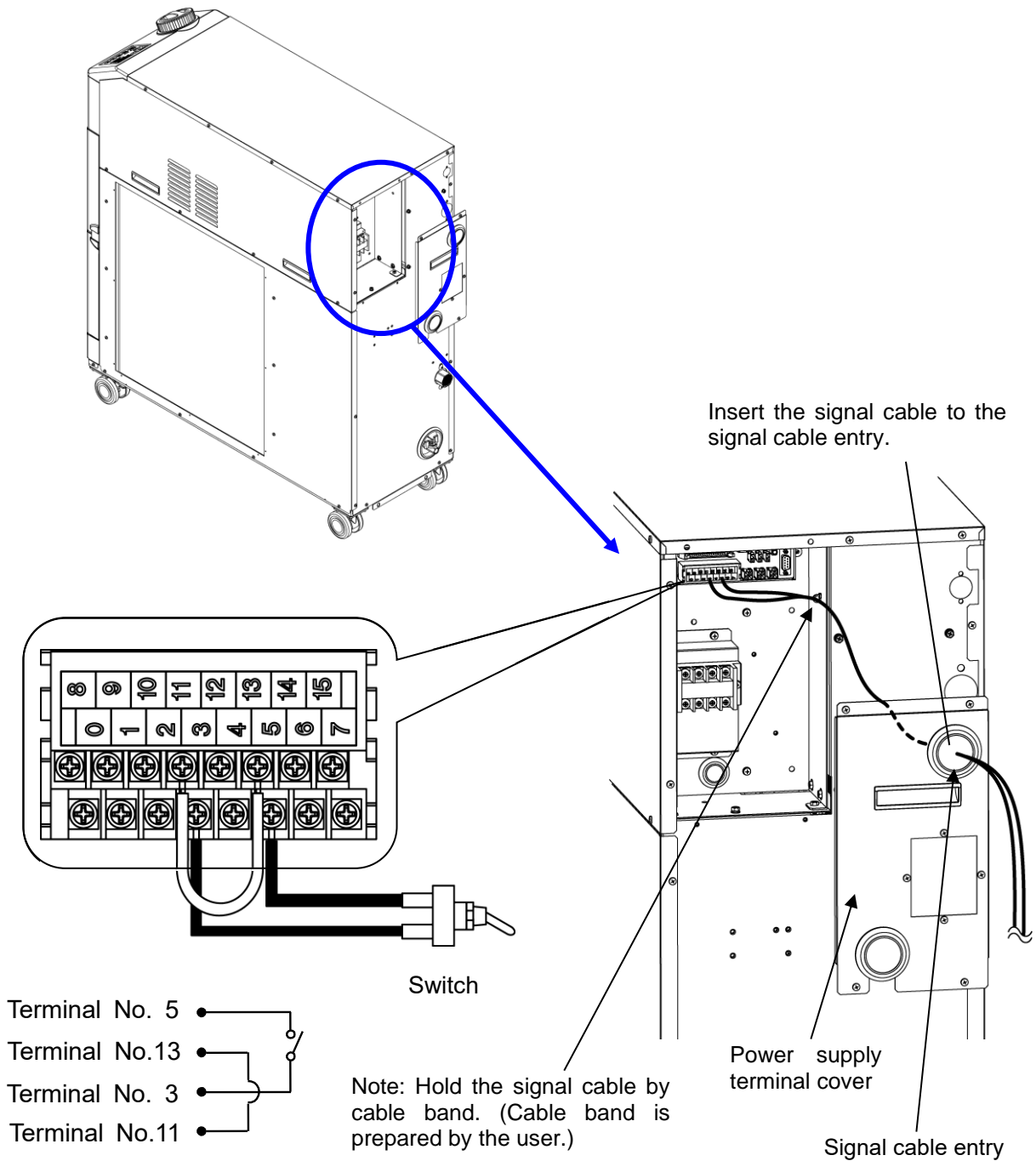

Fig. 3-13 Wiring of Run/stop signal input·Remote signal input (Example)

3.3.6 Wiring of external switch signal input

This product can be monitored by sampling the signal of the external switch prepared by the customer.

Table 3-7 Power supply, contact specifications

Name	Terminal NO.	Specification
Power supply output	5, 6, 7 (DC 24V)	DC 24V ±10% 500mA MAX*1
	13,14, 15 (24V COM)	
Contact input signal 1	3 (Contact input signal 1)	NPN open collector output PNP open collector output (Refer to the operation manual communication function.)
	11 (Common of contact output signal 1)	
Contact input signal 2	4 (Contact input signal 2)	
	12 (Common of contact output signal 2)	

*1: To use the power of the device, the total load current must be 500mA or less.
If the load is 500mA or more, the internal fuse will be cut to protect the product and the alarm [AL21 DC line fuse cut] will be generated. Refer to Chapter 6 for handling of alarms.

One external switch can be connected to contact input signal 1 and one to contact input signal 2. (Two in total) The external switch cannot be connected to the contact input signal 1 depending on the communication mode. Table 3-9 External switches used in examples .

Table 3-8 Sets external switch

Communication mode *1	Contact input signal 1	Contact input signal 2
Local mode	○	○
SERIAL mode	○	○
	○	○
	x	○
DIO mode	x	○

○ : Applicable
x : Not Applicable

*1: Refer to the Communications Operation Manual for more details of each mode.
Local mode: Mode allowing the product to be operated by the operation panel. (Default setting)
SERIAL mode: Mode allowing the product to be operated by serial communication.
DIO mode: Mode allowing the product to be operated by the contact input/output communication.

■ Example of connection

As an example of connection of an external switch, the connecting method is shown below using the SMC flow switch (NPN, PNP).
This chapter illustrates examples of wiring

⚠ WARNING

Be sure to shut off the breaker of the facility power supply (the user's machine power supply) before wiring.

Table 3-9 External switches used in examples

Name	Manufacturer	Part NO.	Out put type	Current consumption
Flow switch	SMC	PF3W711□-□□-A□(-M)	NPN open collector output	50mA or less
		PF3W711□-□□-B□(-M)	PNP open collector output	50mA or less

1. Prepare the flow switch described in the table purchasing separately.
2. Depending on the external switch output type, wire the switch to the terminals for contact input signal as shown below. (This is an example of wiring. Refer to the operation manual communication function for the detail.)

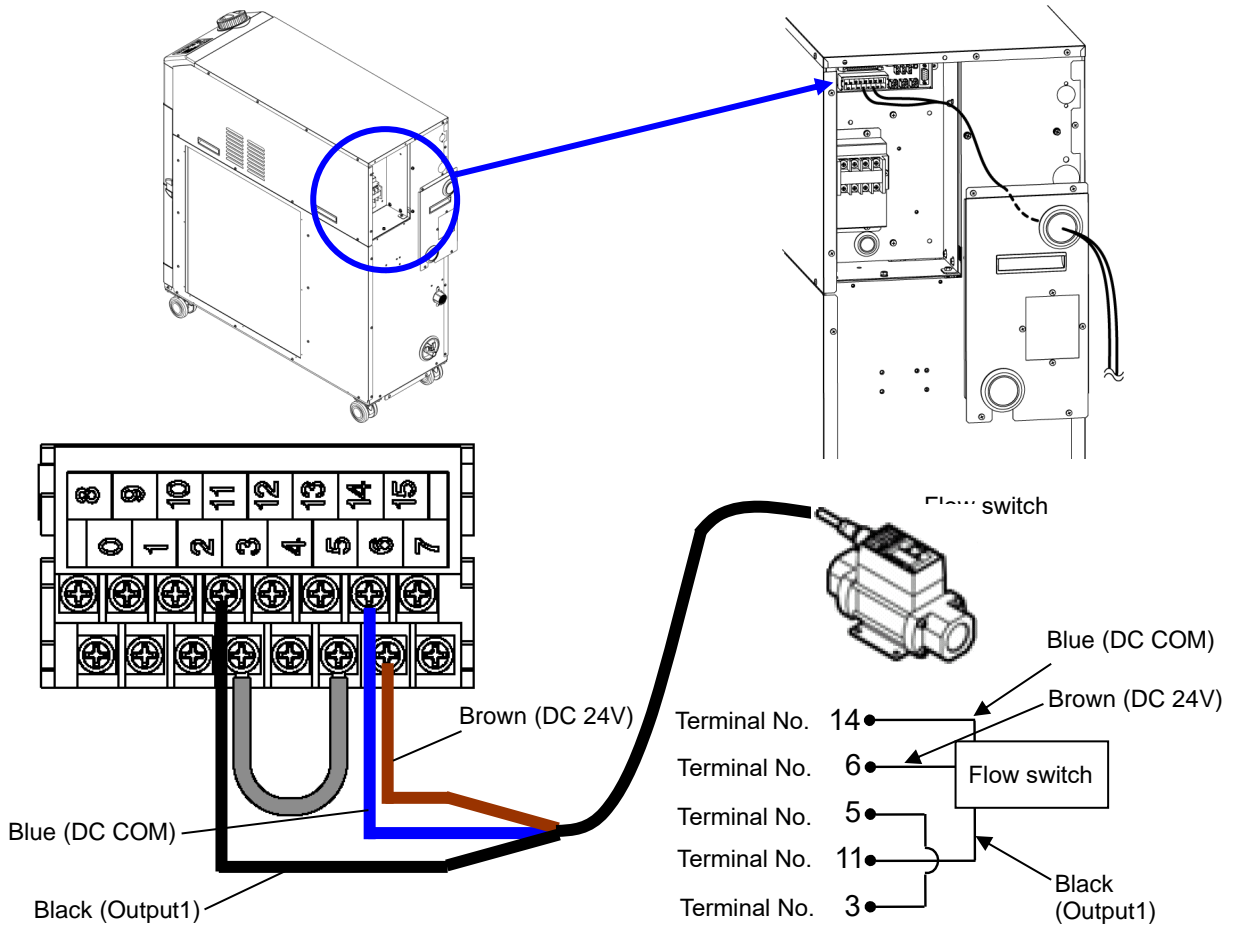

Fig. 3-14 Wiring of the external switch (NPN open collector output) (example)

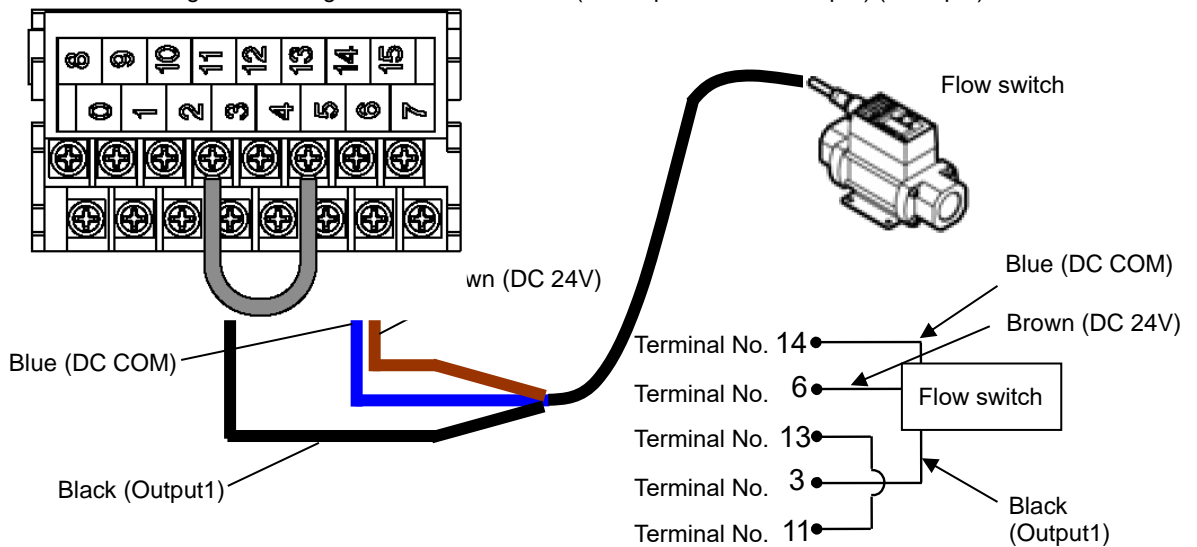

Fig. 3-15 Wiring of the external switch (PNP open collector output) (example)

■ Setting items

Table 3-10 shows the setting items of the external switch. For details, refer to 5.21 Communication function.

Table 3-10 Setting list of the external switch

Display	Item	Initial value (Default setting)	Example*	Reference page	Category
[Co.01]	Communication mode	LOC	LOC	5.21	Communication setting menu
[Co.15]	Contact input signal 1	RUN	SW_A		
[Co.16]	Contact input signal 1 type	ALT	ALT		
[Co.17]	Contact input signal 1 delay timer (time delay) of reading	0	0		
[Co.18]	Contact input signal 1 OFF detection timer	0	2		
[Co.19]	Contact input signal 2	OFF	OFF		
[Co.20]	Contact input signal 2 type	ALT	-		
[Co.21]	Contact input signal 2 delay timer (time delay) of reading	0	-		
[Co.22]	Contact input signal 2 OFF detection timer	0	-		

* Example: Connect flow switch A to contact input signal 1 in local mode.

3.3.7 Wiring of operation signal output and alarm signal output

The operation signal output and alarm signal output are the outputs generated by a contact signal to show the status of the product.

WARNING



Be sure to lock out and tag out the breaker of the facility power supply (customer power supply facility) before wiring.

The specifications of the contact for each signal output are as follows.

Table 3-11 Signal output contact spec. at the time of shipment

Contact output	Signal explanation (Default setting)	Operation	
Contact output signal 1 (Terminal no.0,8)	Operation status signal output	A	At run: Contact closed At stop: Contact open With power supply shut off: Contact open
Contact output signal 2 (Terminal no.1,9)	Remote status signal output	A	At remote: Contact closed At non remote: Contact open With power supply shut off: Contact open
Contact output signal 3 (Terminal no.2,10)	Alarm status signal output	B	At generation: Contact open Not generated: Contact closed With power supply shut off: Contact open

[Tips]

This product has three output signals which can be customized depending on the customer's application

Signals below can be output. Refer to the Communications Operation Manual for more details.

- Ready completion (TEMP READY) signal output
- Operation stop alarm signal output
- Operation continuation alarm signal output
- Selected alarm status signal output
- Operation start timer setting status signal output
- Operation stop timer setting status signal output
- Recovery from power failure setting status signal output
- Anti-freezing setting status signal output
- Contact input signal1, 2 pass through signal output
- Warming up function setting status output

3.3.8 RS-485 Communication wiring

Serial communication RS-485, operation start/stop, setting and reading of circulating fluid temperature, and reading of alarm condition can be done by remote control.

Refer to the Communications Operation Manual for more details.

■ Wiring of interface communication cable

⚠ WARNING

Be sure to lock out and tag out the breaker of the facility power supply (customer power supply facility) before wiring.

● Connecting to PC

RS-485 cannot be directly connected to a normal PC. Use a RS-232C/RS485 converter which is available on the market.

Be sure to follow the wiring procedure below for connecting multiple thermo-chillers.

● Configuration of connection

One host computer : One thermo-chiller, or one host computer : N thermo-chillers.
(Max. 31 thermo-chillers can be connected.)

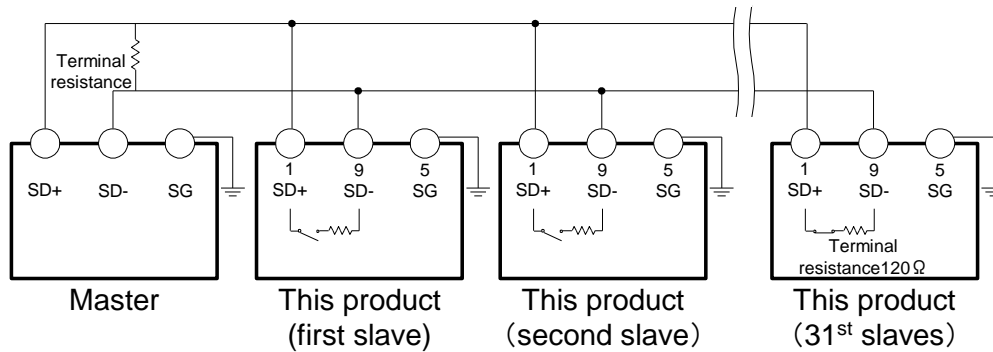

Do not connect any wire to other PIN numbers.

Fig. 3-16 Connection of RS-485

[Tips]

Both ends of the communication connection (the end nodes) need to be connected to the host computer.

With or without the termination resistor (120Ω) of this product can be set by the operation display panel. Refer to "5.21 Communication function".

3.3.9 RS-232C Communication wiring

Serial communication RS-232C, operation start/stop, setting and reading of circulating fluid temperature, and reading of alarm condition can be done by remote control.

Refer to the Communications Operation Manual for more details.

■ Wiring of communication cable

⚠ WARNING



Be sure to lock out and tag out the breaker of the facility power supply (customer power supply facility) before wiring.

Be sure to wire as shown in the figure below.

- Configuration
1 master : 1 thermo-chiller

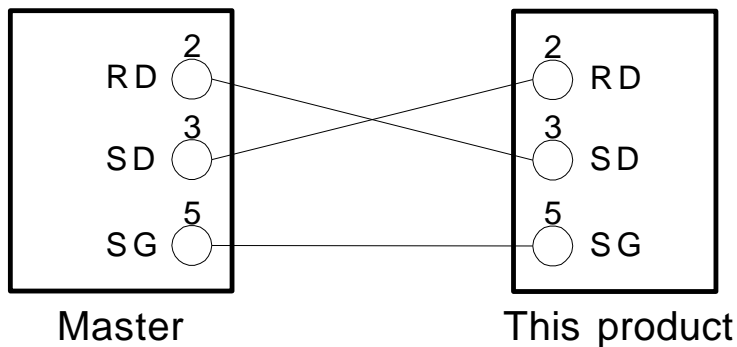

Do not connect any wire to other PIN numbers.

Fig. 3-17 Connection of RS-232C

3.4 Piping

⚠ CAUTION



- Connect piping firmly. Incorrect piping might cause leakage of supplied or drained leakage and wet surrounding area and facility.
- Pay attention not to allow dust and foreign materials to enter into water circuit etc. during connection of piping.
- During piping work, residual liquid may drip from the circulating fluid circuit or facility water circuit. Prepare a drain pan near the pipe connection so that the residual liquid can be received.
- Hold the piping port firmly with specific wrench when tightening.
- The piping should be selected with due consideration of pressure and temperature. Otherwise the piping can burst in service.
- Use non-corrosive material for fluid contact parts of circulating fluid and/or facility water. Also, the use of corrosive materials such as aluminum or iron for fluid contact parts, such as piping, may not only lead to clogging or leakage in the circulating fluid and facility water circuits but also refrigerant leakage and other unexpected problems. Provide protection against corrosion when you use the product.
- Do not generate a rapid change of pressure by water hammer etc. The product and external piping might be damaged.
- Facility water temperature of the facility water outlet port might

■ Piping port size

Table 3-12 Piping port size

Name	Port size ^{□1}	Recommended tightening torque	Recommended piping specification
Circulating fluid supply	Rc1	36 to 38N·m	1.0MPa and more
Circulating fluid return	Rc1	36 to 38N·m	1.0MPa and more
Drain port	Rc1/4	8 to 12N·m	-
Facility water inlet *1	Rc1/2	28 to 30N·m	1.0MPa and more. (Supply puressure : 0.3 to 0.5MPa)
Facility water outlet *1	Rc1/2	28 to 30N·m	
Automatic water-fill port *2	Rc3/8	22 to 24N·m	1.0MPa more (Automatic water-fill pressure 0.2 to 0.5MPa)
Overflow port *2	Rc3/4	28 to 30N·m	Inside diameter 19mm more of piping

*1 : Water cooled type only.

*2 : For Option J [Automatic fluid filling]

[Tips]

<In case of HRSH***-AN-**-*, HRSH***-WN-**-*>

A set of thread adapters that converts the connections from Rc to NPT is enclosed as an accessory. Be sure to use this for NPT piping.

<In case of HRSH***-AF-**-*, HRSH***-WF-**-*>

A set of thread adapters that converts the connections from Rc to G is enclosed as an accessory. Be sure to use this for G piping.

■ **How to connect piping**

Tighten the piping to each connection as follows below.

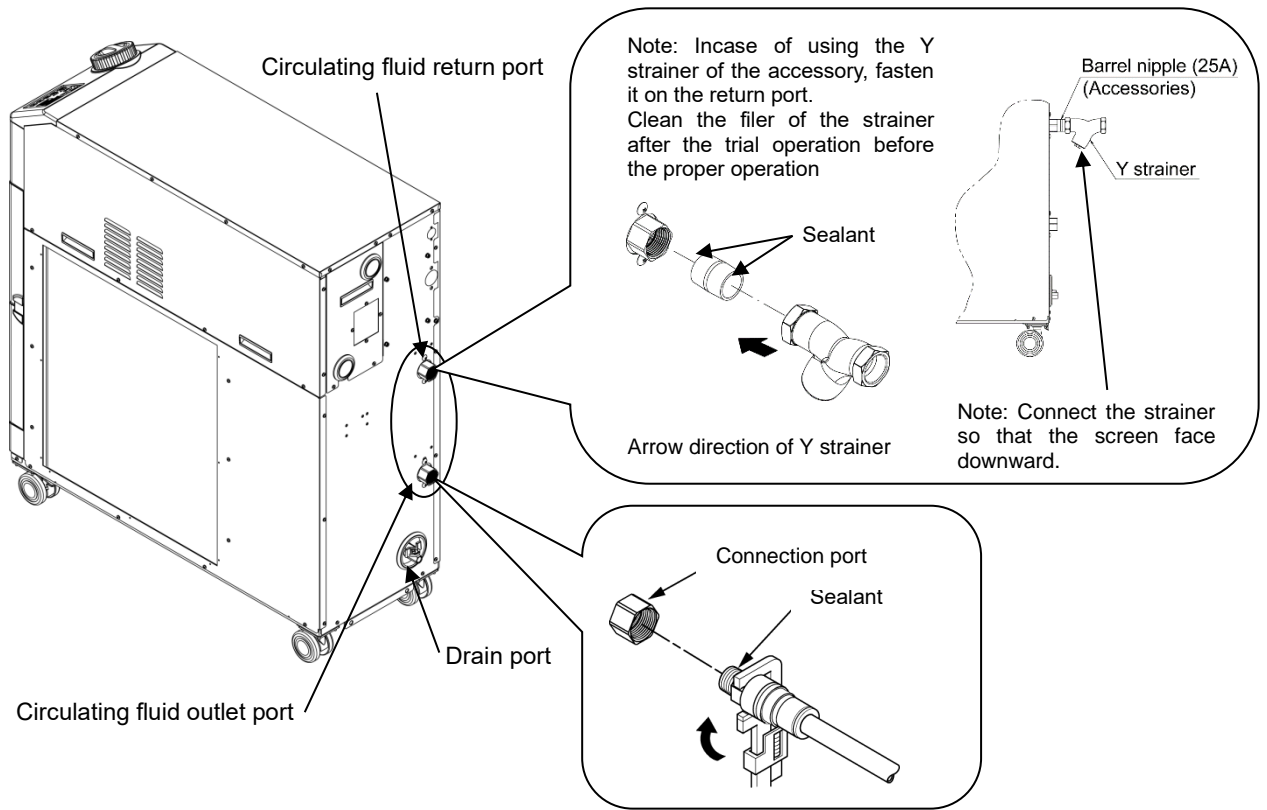

Fig. 3-18 Tightening of piping

■ **How to connect to the drain port**

When piping the drain port, hold the ball valve of the drain port with a wrench not to rotate it.

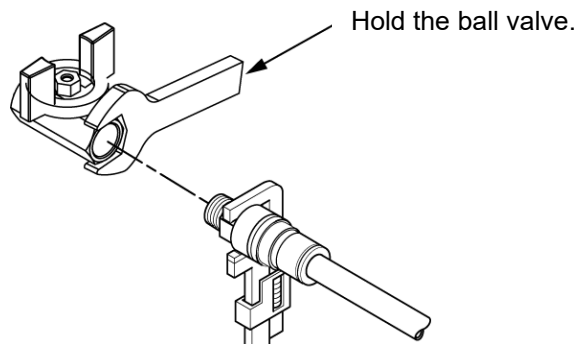

Fig. 3-19 Connection to the drain

⚠ CAUTION

! Without holding the ball valve of the drain port with a wrench, the ball valve may rotate and it may cause a fluid leakage and malfunction of the product. Be sure to hold the ball valve of the drain port.

■ Recommended piping circuit

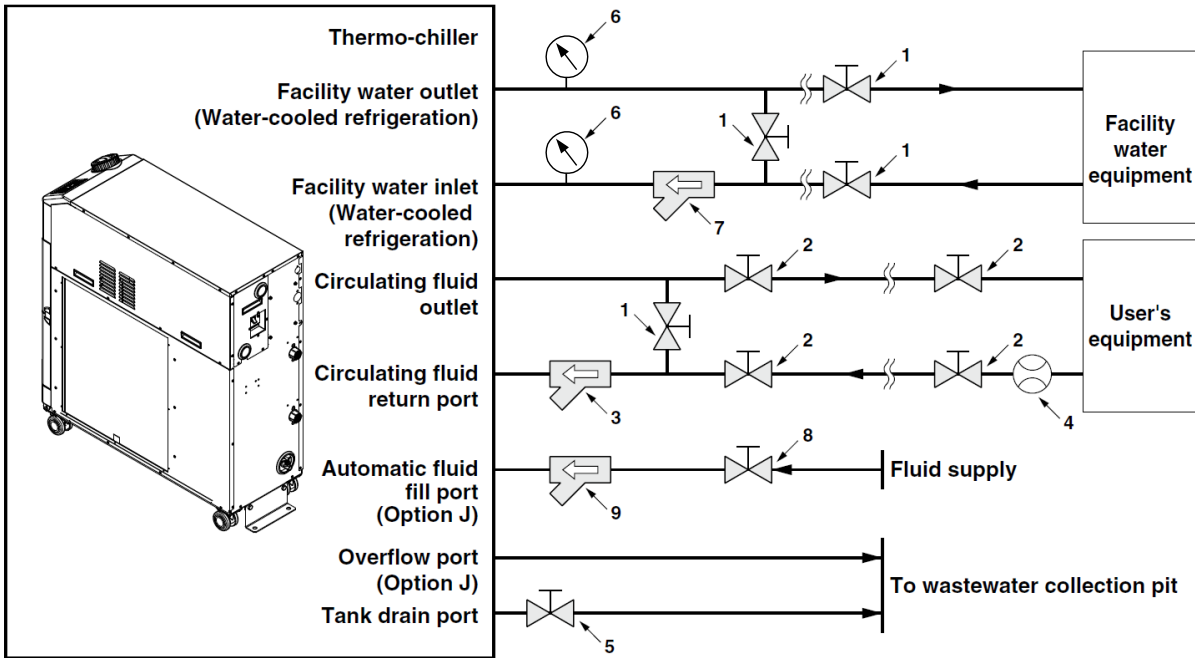

Fig. 3-20 Recommended piping circuit

No.	Description	Size	Recommended part no.	Note
1	Valve	Rc1/2	-	To prevent liquid spillage from the customer's piping or overflow from the tank during maintenance work.
2	Valve	Rc1	-	
3	Y-strainer	Rc1 #40	Accessory	Install either the strainer or filter. If foreign objects with a size of 20 μm or more are likely to enter, install the particle filter.
	Filter	Rc1 20μm	HRS-PF005 ^(Note)	
4	Flow meter	-	-	Prepare a flow meter with an appropriate flow range.
5	Valve (Part of thermo-chiller)	Rc1/4	-	-
6	Pressure gauge	0 to 1.0MPa	-	-
7	Y-strainer	Rc1/2 #40	-	Install either the strainer or filter. If foreign objects with a size of 20 μm or more are likely to enter, install the particle filter.
	Filter	Rc1/2 20μm	-	
8	Valve	Rc3/8	-	-
9	Y-strainer	Rc3/8 #40	-	Install either the strainer or filter. If foreign objects with a size of 20 μm or more are likely to enter, install the particle filter.
	Filter	Rc3/8 20μm	FQ1011N-10-T020-B-X61 ^(Note)	

Note) The filter shown above cannot be directly connected to the thermo-chiller. Install it in the user's piping system.

3.5 Fill of circulating fluid

Turn the tank lid anticlockwise to open. Supply the circulating fluid up to the "H" mark on the fluid level indicator. Use tap water which satisfies the water quality standard shown in Table 8-1, or a 15% aqueous solution of ethylene glycol.

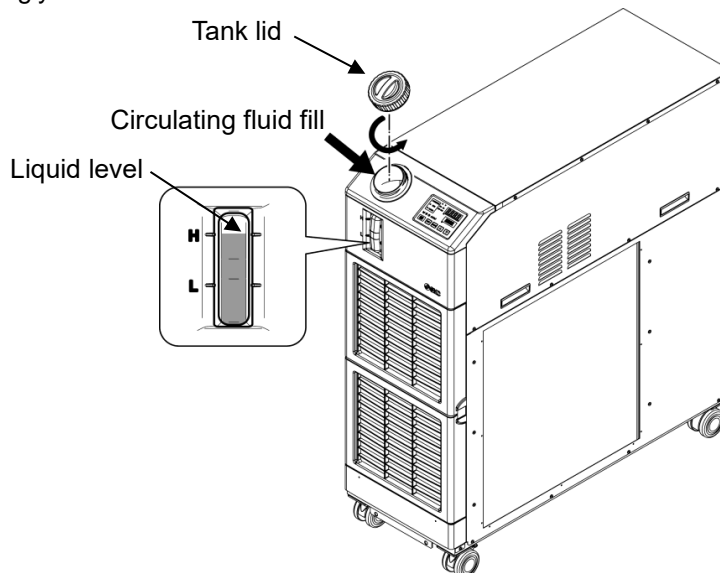

Fig. 3-21 Circulating fluid fill

(Tips)

Supply the circulating fluid to the tank directly with option J [automatic fluid filling] when the tank is empty. Supply the circulating fluid to the empty tank by only automatic fluid filling, it causes the alarm "AL01; Low level in tank".

CAUTION



- If tap water is used, refer to 8.1 Control of Circulating Fluid, facility water Quality.
- If 15% ethylene glycol aqueous solution is used, dilute pure ethylene glycol with water. Additives such as antiseptics cannot be used.
- If deionized water is used, the conductivity should be $1\mu\text{S}/\text{cm}$ and higher (Electrical resistivity: $1\text{M}\Omega\cdot\text{cm}$ and lower).
- Check the drain port is closed by the valve to prevent the supplied circulating fluid from draining out.
- Supply the circulating fluid up to the "H" mark on the tank. Operation will stop when the fluid level falls lower than "L".

CAUTION



- When the circulating fluid temperature is lower than 10 deg. C, use 15% aqueous solution of ethylene glycol. Otherwise it may cause icing of the fluid.

■ 15% aqueous solution of ethylene glycol

When a 15% aqueous solution of ethylene glycol is used, prepare the ethylene glycol aqueous solution separately.

To control the density of the ethylene glycol aqueous solution, a densitometer is available separately from SMC.

Item	No	Remarks
Ethylene glycol aqueous solution 60%	HRZ-BR001	Please dilute to 15% with tap water and use it.
Densitometer	HRZ-BR002	—

3.6 Option J Piping of [Automatic fluid filling]

Automatic fluid filling port and over flow port need to be connected when optional [automatic fluid filling] is selected.

■ Piping to automatic fluid filling port

Connect the piping to supply the circulating fluid. Automatic fluid filling is performed by using the solenoid valve which is built in the thermo-chiller.

■ Piping to the overflow port

This is necessary when automatic fluid filling function is used. Discharge excess circulating fluid when the fluid level in the tank rises due to the failure of the solenoid valve etc.

Piping name	Port size	Piping specifications
Automatic water-fill inlet	Rc3/8	Supply pressure : 0.2 to 0.5MPa Supply temperature : 5 to 40°C
Overflow outlet	Rc3/4	Piping should be within 19mm of I.D. and 5m of length. Riser piping (trapping area) should be avoided.

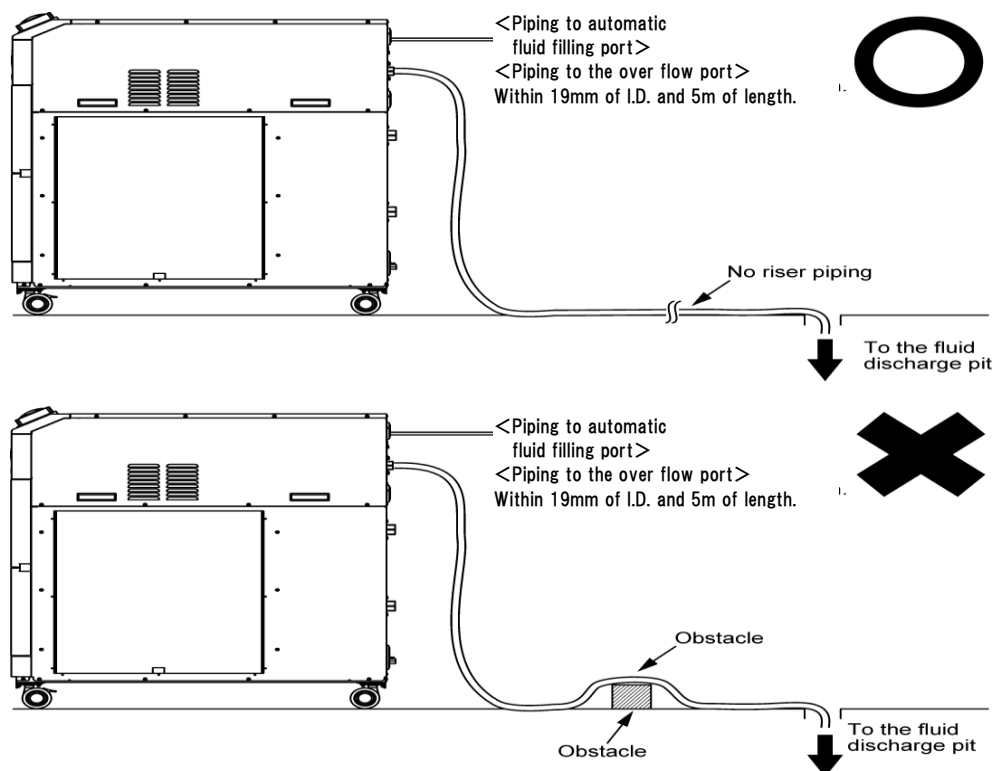

Fig. 3-22 Piping to automatic fluid filling port and overflow port

■ Supplying fluid from the automatic fluid filling port

Fluid filling starts if the power supply is turned ON when the fluid level of the circulating fluid is "L" of the level indicator or lower (4.2 Preparation for Start). Fluid supply stops when the fluid level reaches the proper level. If the fluid level does not reach the proper level in a certain time after starting supplying fluid, it causes the alarm "AL01; Low level in tank". Fluid supply continues while the alarm is generated. Fluid supply stops after the fluid level reaching proper level. Alarm continues after fluid supply is completed. Release the alarm referring Chapter 6.

Chapter 4 Starting the Product

CAUTION



Only people who have sufficient knowledge and experience about the product and its accessories are allowed to start and stop the product.

4.1 Before Starting

- Check the following items before starting the product.

■ Installation conditions

- Check the product is installed horizontally.
- Check that there are no heavy objects on the product, and the external piping is not applying excessive force to the product.

■ Connection of cables

- Check the power, ground and communications (optional) cables are correctly connected.

■ Circulating fluid

- Check proper connection of piping at inlet and outlet.

■ Fluid level gauge

- Ensure that the fluid level is on “H”.

■ Facility water piping (For water cooled type)

- Check proper connection of piping at the facility water inlet and outlet.
- Check that the facility water source is in operation.
- Check that the facility water circuit is not shut off by valves.

CAUTION



- Supply facility water within the specified “Table 8-1” and “9.1 Specifications”.

[Tips]

In case of water cooled type, it has water regulation valve in facility water circuit. Facility water might not flow if this product stopping.

4.2 Preparation for Start

4.2.1 Power supply

Turn on the breaker of the customer's power supply.

When the product is switched on, the operation panel displays the following conditions.

- The initial screen (HELLO screen) is displayed for 8 seconds on the operation display panel. Then, the display changes to the main screen which displays the circulating fluid discharge temperature.
- The set value of circulating fluid temperature is displayed as SV on the panel.
- The present value of circulating fluid temperature is displayed as PV on the panel.

■ For the option B, option S and HRSH090-**-40-*

Turn on the breaker switch on the back of the product.

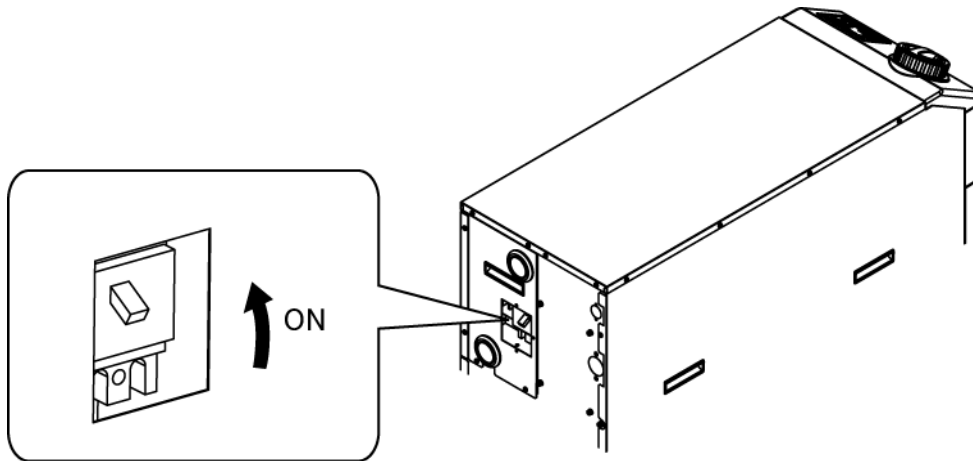

Fig. 4-1 Power supply

4.2.2 Setting of circulating fluid temperature

Press the [▼] and [▲] buttons on the operational panel to change the SV to required value.

When the temperature of the circulating fluid is set by the communication, refer to "Communication" in the supplementary operation manual.

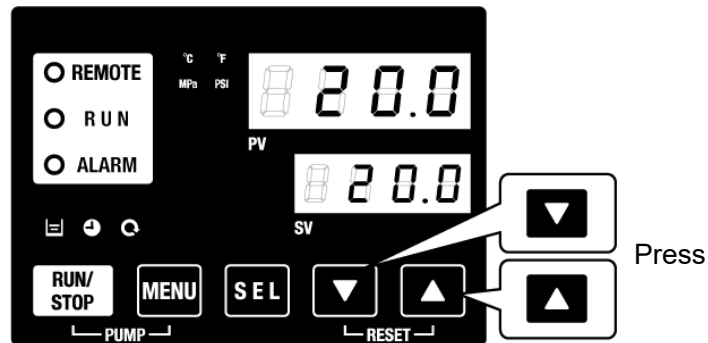

Fig. 4-2 Setting of circulating fluid temperature

4.2.3 Setting of pump operation mode

The initial setting of the pump operation mode is pressure controlled mode and the pressure setting is 0.5MPa. Regarding the pump operation mode, refer to "5.17Pump operation mode function".

4.3 Preparation of circulating fluid

When the circulating fluid tank is filled the user’s machine and piping remains empty. In that condition, the circulating fluid flows out to the user’s machine and piping and the tank level decreases and may require a refill. In that case, refill the circulating fluid in the following procedure.

1. Press the [PUMP] key on the operation display panel (press the [RUN/STOP] key and [MENU] key simultaneously).

The pump operates independently while the [PUMP] key is pressed. The [RUN] lamp (green) flashes while the pump is operating independently, and the circulating fluid in the tank is supplied to the customer’s device and piping. This can be done to check for leakage, and to discharge air from the piping. If the fluid level in the tank reaches the lower limit, a buzzer will sound, and alarm no. “AL01 (tank fluid level is low)” is displayed on the digital display PV. The [ALARM] lamp (red) flashes, the [] lamp turns on. In this case, release the alarm referring clause 2.

CAUTION

If leakage occurs, stop manual operation of the pump and fix the leak.

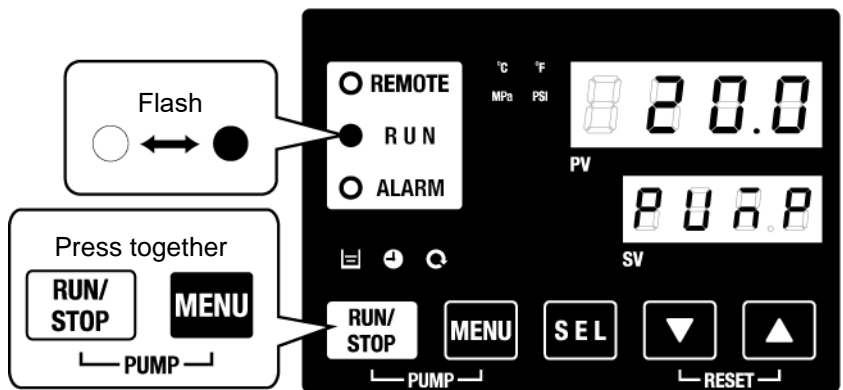

Fig. 4-3 Manual operation of the pump

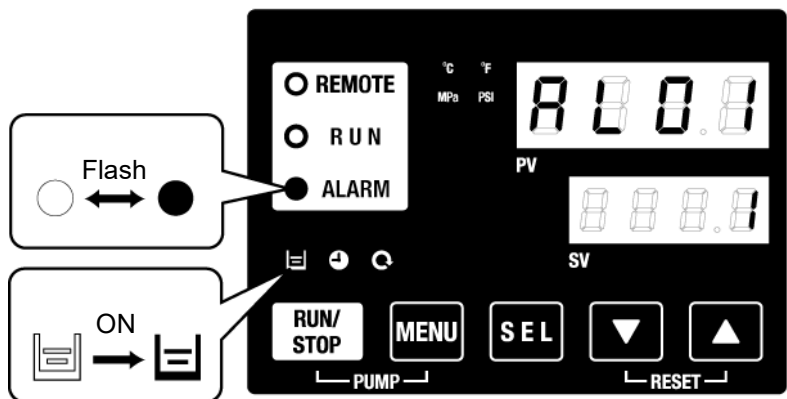

Fig. 4-4 Low tank level alarm

2. Press the [RESET] key ([▼] and [▲] keys simultaneously) to stop the alarm buzzer.

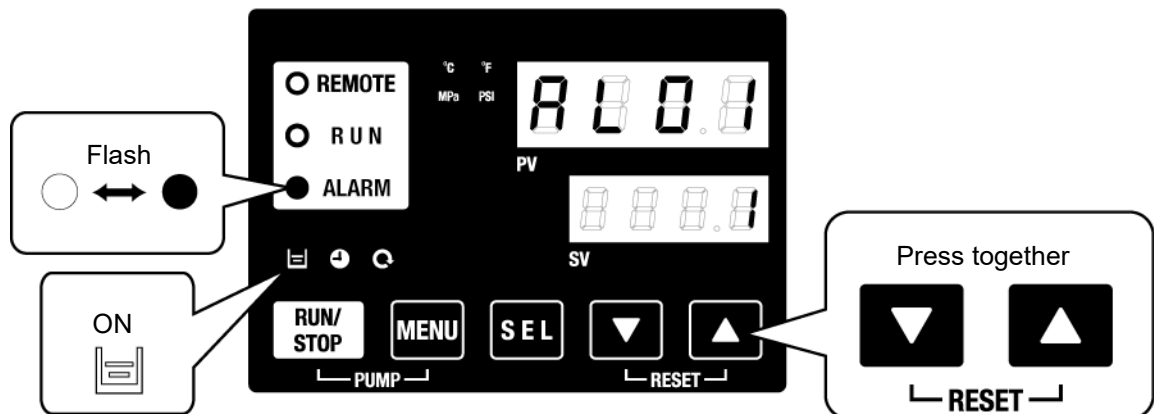

Fig. 4-5 Alarm receipt

CAUTION

Be sure to reset the alarm on the operation display panel of the alarm. Alarm reset is not accepted from any screen except the alarm display menu. Refer to 5.2.1 Key operations.

3. Open the tank lid and supply the circulating fluid up to the "H" mark on the tank.

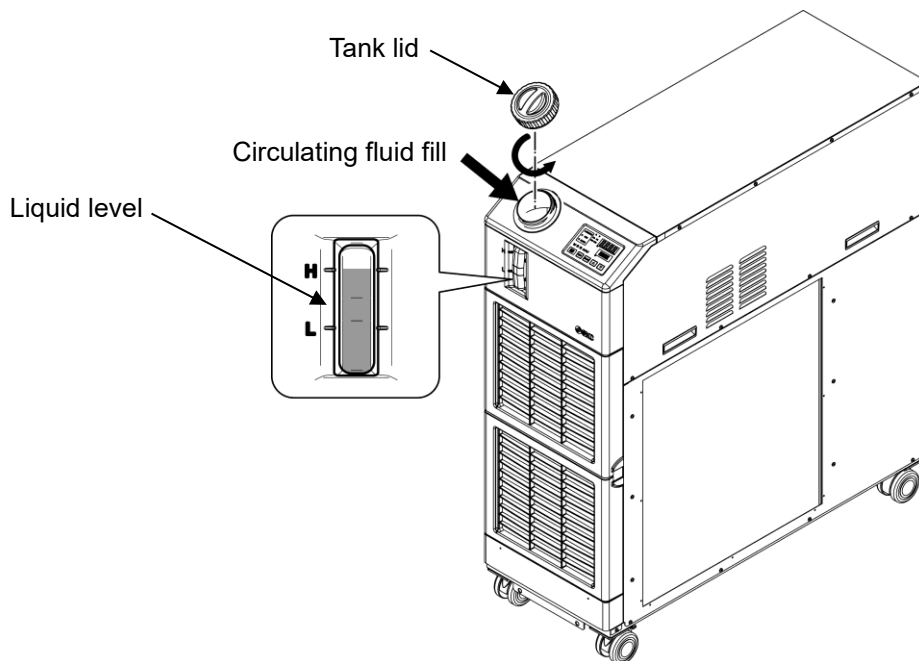

Fig. 4-6 Filling of Circulating Fluid

CAUTION



- Check the drain port is plugged or closed by the valve to prevent the supplied circulating fluid from draining out.
- When the fluid level falls lower than "L", the alarm will be generated.

- 4.** Press the [RESET] key ([▼] and [▲] keys simultaneously) to reset the alarm.

The alarm (tank fluid level is low) is reset, and the [ALARM] lamp and [≡] lamp are turned off. The display returns to the initial screen of the main menu: “Circulating fluid temp. / Circulating fluid set temp.” Press the [PUMP] key (press [RUN/STOP] key and [MENU] key simultaneously) to start independent operation of the pump.

CAUTION

Be sure to reset the alarm on the operation display panel of the alarm. Alarm reset is not accepted from any screen except the alarm display menu. Refer to 5.2.1 Key operations.

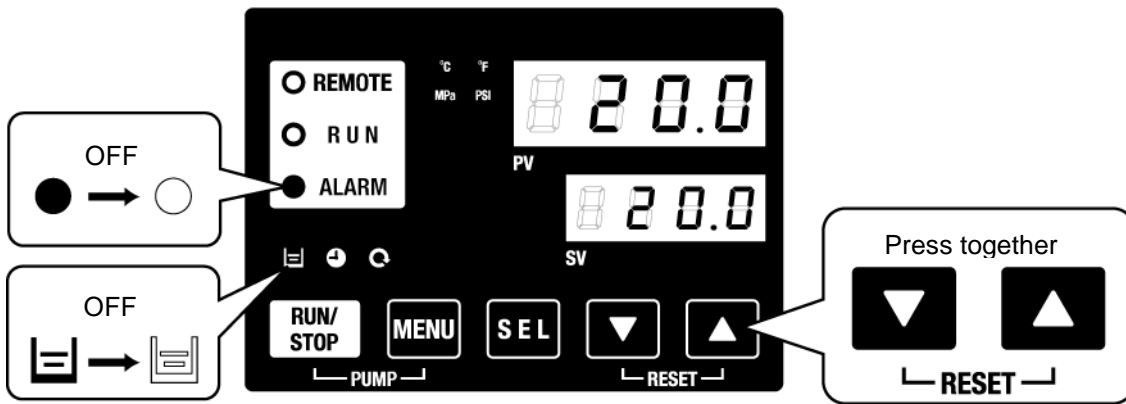

Fig. 4-7 Alarm release

- 5.** Repeat steps 1 to 4 to supply the circulating fluid to the customer’s equipment and piping. The tank level must be “H” on the tank liquid level indicator.

4.4 Starting and Stopping

4.4.1 Starting the product

CAUTION



Allow at least five minutes before restarting the product.

Before starting, check the items specified in “4.1 Before Starting”

If any alarm lamp remains on, refer to Chapter 7 Alarm indication and trouble shooting”

1. Press the [RUN/STOP] key on the operation panel.

The [RUN] lamp lights up (in green) and the product starts running. The circulating discharge temperature (PV) is controlled to the set temperature (SV).

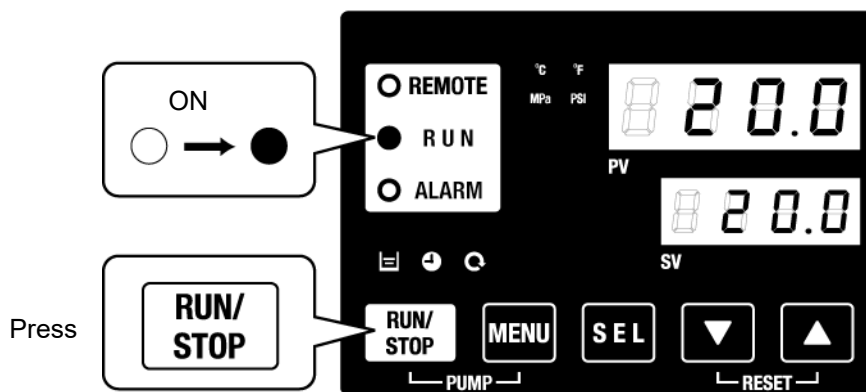

Fig. 4-8 Starting the product

CAUTION

When an alarm occurs, refer to “Chapter 7 Alarm indication and trouble shooting”.

4.4.2 Stopping the product

1. Press the [RUN/STOP] button on the operation panel.

The [RUN] lamp on the operation panel flashes green at 1 second intervals, and continues operation to prepare to stop. After approx. 20 seconds, the [RUN] lamp goes off and the product stops.

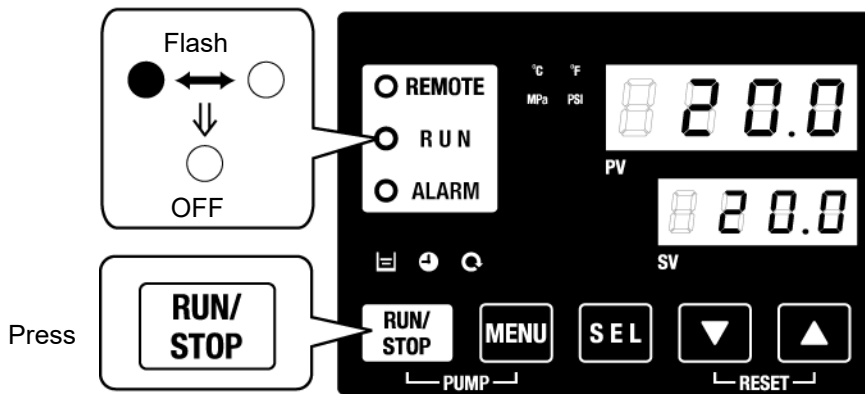

Fig. 4-9 Stopping the product

2. Shut off the breaker of the customer's power supply.

CAUTION



Except in case of emergency, do not turn off the breaker until the product has stopped completely. Otherwise it may cause a failure.

4.5 Check items after starting

Check the following items after starting the product.

 WARNING	
	When an Alarm is seen, press the [STOP] button and then turn off the breaker to stop the product, and turn off the breaker of the user's power supply to isolate the product.

- There is no leakage from piping.
- There is no drain of circulating fluid from the drain port.
- The circulating fluid pressure is within the specified range.
- The tank level is within the specified range.

4.6 Adjustment of Circulating Fluid flow rate

■ Circulating fluid flow rate adjustment

If the flow rate is lower than the minimum operating flow rate, the performances may not be able to achieve the specified ones and the compressor may not start running.

Adjust the hand valve installed by the customer side referring to Fig. 3-20 Recommended piping circuit to make the desired pressure or/and flow rate.

[Tips]

Regarding the minimum operation flow rate, refer to "9.1 Specifications".

CAUTION	
	If the valve locates in circulating piping, do not fully close the valve (0L/min). The pump may be damaged.

Chapter 5 Display and setting of various functions

⚠ WARNING



Read and understand this manual carefully before changing the settings.

5.1 List of function

The product can have the displays and settings shown in Table 5-1.

Table 5-1 List of function

NO	Function	Outline	Reference page
1	Main display	Displays the current temperature of the circulating fluid, discharge pressure of the circulating fluid change the circulating fluid temperature.	5.3
2	Alarm display menu	Indicates alarm number when an alarm occurs.	5.4
3	Inspection monitor menu	Product temperature, pressure and accumulated operating time can be checked as daily inspection. Use these for daily inspection.	5.5
4	Key-lock	Keys can be locked so that set values cannot be changed by operator error.	5.6
5	Timer for operation start /stop	Timer is used to set the operation start/stop.	5.7
6	Signal for the completion of preparation	A signal is output when the circulating fluid temperature reaches the set temperature, when using contact input/output and serial communication.	5.8
7	Offset function	Use this function when there is a temperature offset between the discharge temperature of the thermo-chiller and the customer's device.	5.9
8	Reset after power failure	Start operation automatically after the power supply is turned on.	5.10
9	Key click sound setting	Operation panel key sound can be set on/off.	5.12
10	Changing temp. unit	Temperature unit can be changed. Centigrade(°C) ↔ Fahrenheit(°F)	5.13
11	Changing pressure unit	Pressure unit can be changed. MPa ↔ PSI	5.14
12	Data reset	Functions can be reset to the default settings (settings when shipped from the factory).	5.15
13	Accumulation time reset	Reset function when the pump, the fan or the compressor is replaced. Reset the accumulated time here.	5.16
14	Pump operation mode set	The fluid supply mode of the pump can be changed Pressure control mode ↔ Frequency set mode	5.17
15	Anti-freezing function	Circulating fluid is protected from freezing during winter or night. Set beforehand if there is a risk of freezing.	5.11
16	Warming up function	When circulating fluid temperature rising time at starting needs shortening during winter or night, set beforehand.	5.18
17	Setting of alarm buzzer	Alarm sound can be set to on/off.	5.19
18	Alarm customizing	Operation during alarm condition and threshold values can be changed depending on the alarm type.	5.20
19	Communication	This function is used for contact input/output or serial communication.	5.21

5.2 Function

5.2.1 Key operations

“Fig. 5-1 Key operation (1/2)” and “Key operation (2/2)” shows the operation of keys of the thermo-chiller.

By pressing the “SEL” key for 2 seconds, the PV display blinks and function of “SEL” key, display change becomes opposite turn.

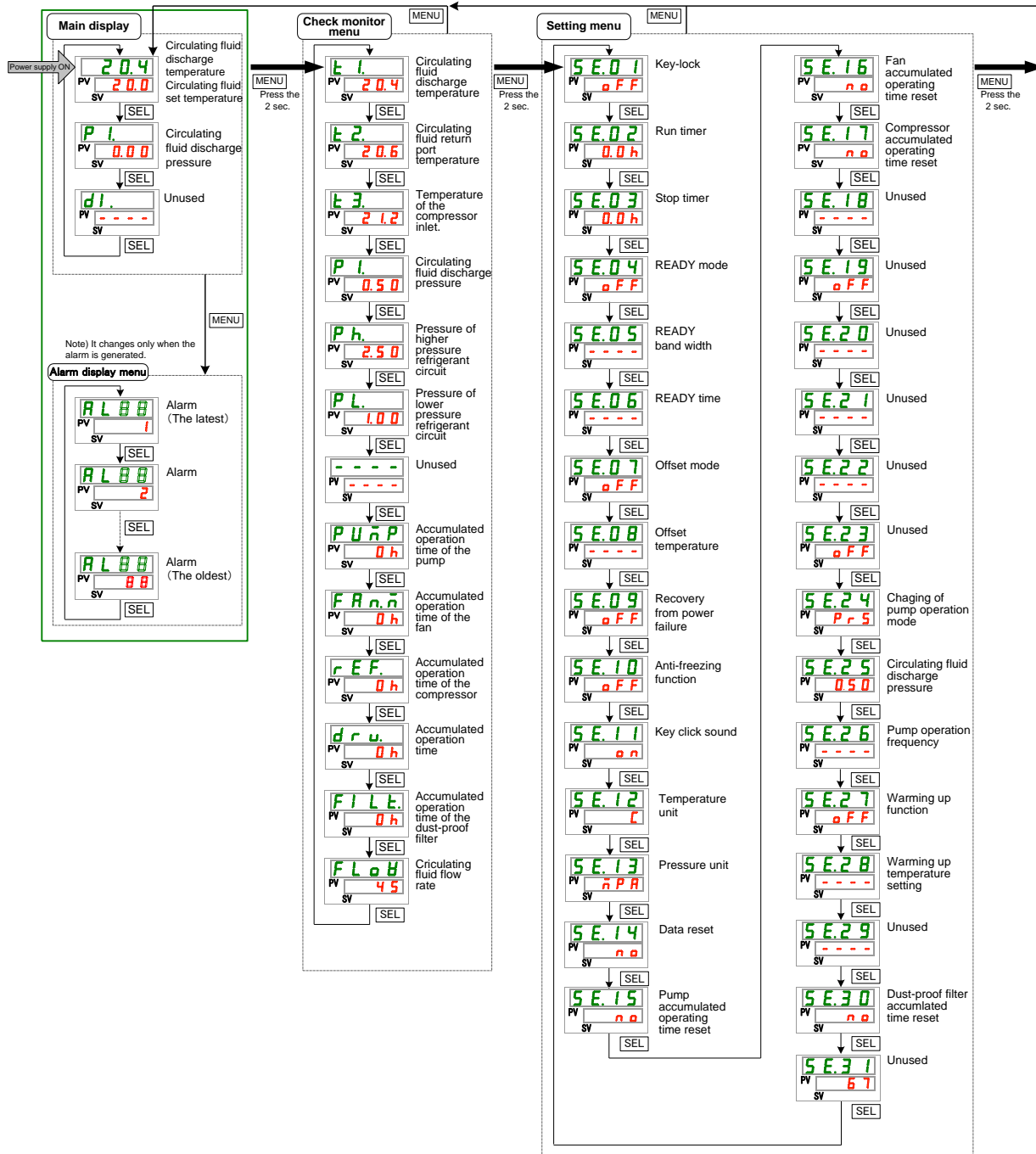

Fig. 5-1 Key operation (1/2)

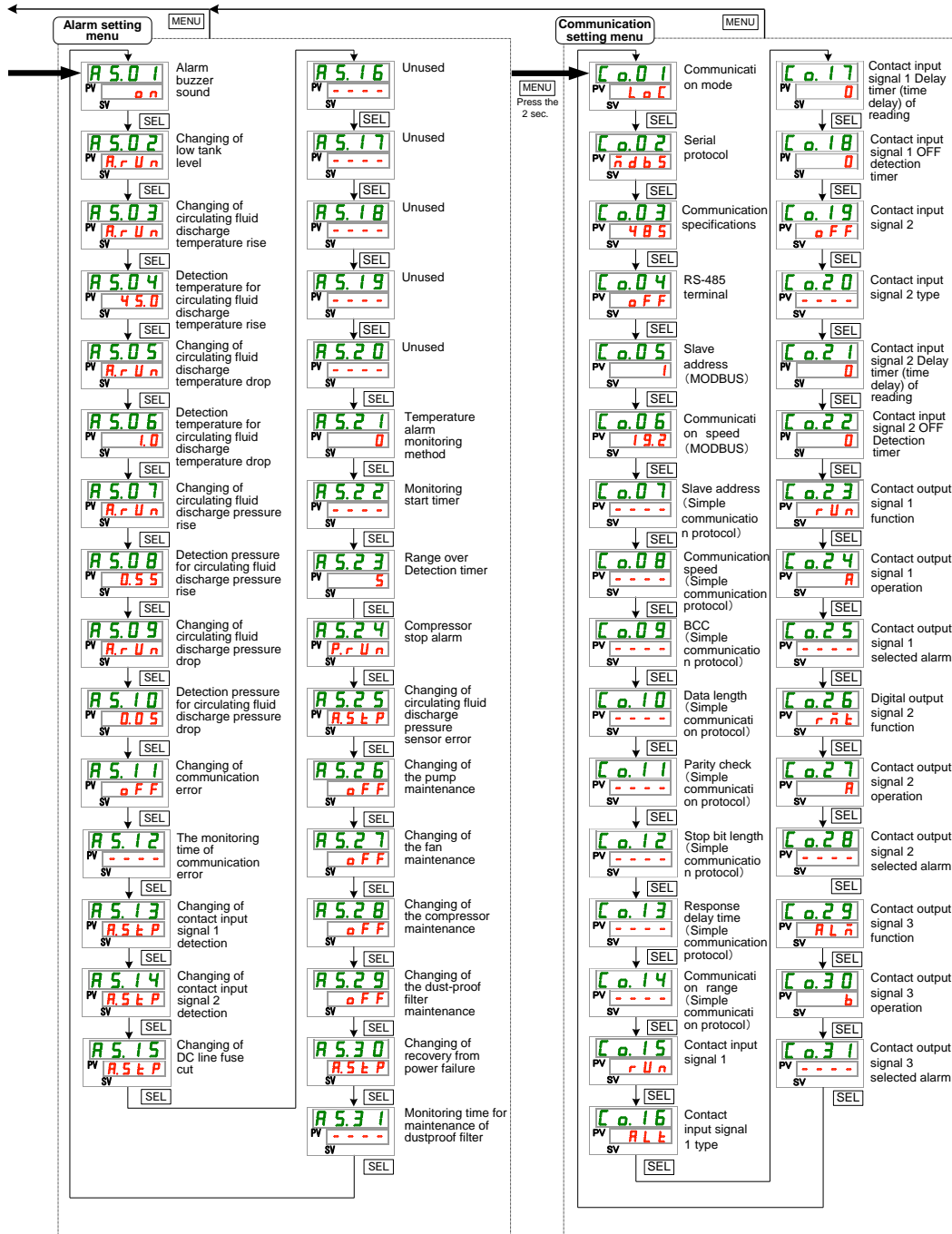

Fig. 5-2 Key operation (2/2)

5.2.2 List of parameters

Table 5.2-1“List of parameter (1/3)” and Table 5.2-3“List of parameter (3/3)” show the parameters of the thermo-chiller.

Table 5.2-1 List of parameter (1/3)

Display	Content	Default setting*1	Reference page	Category
Temperature P I. - - - -	Circulating fluid temperature(TEMP PV)		5.3	Main display
	Circulating fluid set temperature(TEMP SV)	20 °C (68°F)		
	Circulating fluid discharge pressure			
	Unused			
AL x x	Alarm No.		5.4	Alarm display menu
t 1. t 2. t 3. P I. P h. P L. - - - - P U n P F A n n r E F. d r u. F I L E. F L o H	Circulating fluid discharge temperature Circulating fluid return port temperature Temperature of the compressor inlet. Circulating fluid discharge pressure Pressure of higher pressure refrigerant circuit Pressure of lower pressure refrigerant circuit Unused Accumulated operation time of the pump Accumulated operation time of the fan Accumulated operation time of the compressor Accumulated operation time Accumulated operation time of the dust-proof filter Circulating fluid flow rate		5.5	Check monitor menu
SE.01 SE.02 SE.03 SE.04 SE.05 SE.06 SE.07 SE.08 SE.09 SE.10 SE.11 SE.12 SE.13 SE.14 SE.15 SE.16 SE.17 SE.18 SE.19 SE.20 SE.21 SE.22 SE.23	Key-lock Run timer Stop timer READY mode READY band width READY time Offset mode Offset temperature Recover from power failure Anti-freezing function Key click sound Temperature unit Pressure unit Data reset Pump accumulated operating time reset Fan accumulated operating time reset Compressor accumulated operating time reset Unused Unused Unused Unused Unused	OFF 0.0H 0.0H OFF ---- (0 °C (0 °F))*2 ---- (10) *2 OFF ---- (0 °C (0 °F))*3 OFF OFF ON C MPa NO NO NO NO ---- ---- ---- ---- ----	5.6 5.7 5.8 5.9 5.10 5.11 5.12 5.13 5.14 5.15 5.16 5.16 5.16 5.16 5.16 5.16 5.16 5.16 5.16 5.16 5.16 5.16	Setting menu

*1: Values in ° F are displayed when SE12 is F.
 *2: The default setting when SE04 is ON.
 *3: The default setting when SE07 is MD1, 2 or 3.

Table 5.2-2 List of parameter (2/3)

Display	Content	Default setting*4	Reference page	Category
SE24	Changing of pump operation mode	PRS	5.17	Setting menu
SE25	Circulating fluid discharge pressure	0.50MPa (72PSI) (----)*5		
SE26	Pump operation frequency	---- (40)*5		
SE27	Warming up function	OFF	5.18	
SE28	Warming up temperature setting	---- (20.0 °C (68.0 ° F))*6		
SE29	Unused	----		
SE30	Dust-proof filter accumulated time reset	NO	5.16	
SE31	Unused	(67)		
AS01	Alarm buzzer sound	ON	5.19	Alarm setting menu
AS02	Changing of low tank level	A.RUN	5.20	
AS03	Changing of circulating fluid discharge temperature rise	A.RUN		
AS04	Detection temperature for circulating fluid discharge temperature rise	45.0 °C (113.0 ° F) (----)*7		
AS05	Changing of circulating fluid discharge temperature drop	A.RUN		
AS06	Detection temperature for circulating fluid discharge temperature drop	1.0 °C (33.8 ° F) (----)*7		
AS07	Changing of circulating fluid discharge pressure rise	A.STP		
AS08	Detection pressure for circulating fluid discharge pressure rise	0.55MPa (80PSI) (----)*7		
AS09	Changing of circulating fluid discharge pressure drop	A.STP		
AS10	Detection pressure for circulating fluid discharge pressure drop	0.05MPa (7PSI) (----)*7		
AS11	Changing of communication error	OFF		
AS12	The monitoring time of communication error	---- (30)*7		
AS13	Changing of Contact input signal 1 detection	A.STP		
AS14	Changing of Contact input signal 2 detection	A.STP		
AS15	Changing of DC line fuse cut	A.STP		
AS16	Unused	----		
AS17	Unused	----		
AS18	Unused	----		
AS19	Unused	----		
AS20	Unused	----		
AS21	Temperature alarm monitoring method	0		
AS22	Monitoring start timer	---- (0)*7		
AS23	Range over Detection timer	5		
AS24	Compressor stop alarm	P.RUN		

*4: Values in ° F are displayed when SE12 is F and PSI are displayed when SE13 is PSI.

*5: The default setting when SE24 is FREQ.

*6: The default setting when SE27 is ON.

*7: Regarding the detail of the default setting, refer to "5.20Alarm customizing function".

Table 5.2-3 List of parameter (3/3)

Display	Content	Default setting	Reference page	Category	
A 5.25	Changing of circulating fluid pressure sensor error	A.STP	5.20	Alarm setting menu	
A 5.26	Changing of the pump maintenance	OFF			
A 5.27	Changing of the fan maintenance	OFF			
A 5.28	Changing of the compressor maintenance	OFF			
A 5.29	Changing of the dust-proof filter maintenance	OFF			
A 5.30	Changing of the recovery from power failure	A.STP			
A 5.31	Monitoring time for maintenance of dustproof filter	----			
C 0.01	Communication mode	LOC	5.21	Communication setting menu	
C 0.02	Serial protocol	MDBS			
C 0.03	Communication specifications	485			
C 0.04	RS-485 terminal	OFF			
C 0.05	Mod bus	Slave address			1 (----)*8
		Communication speed			19.2 (----)*8
C 0.06	Simple communication protocol	Slave address			---- (1)*8
		Communication speed			---- (9.6)*8
		BCC			---- (ON)*8
		Data length			---- (8BIT)*8
		Parity check			---- (NON)*8
		Stop bit length			---- (2BIT)*8
		Response delay time			---- (0)*8
		Communication range			---- (RW)*8
C 0.15	Contact input signal 1	RUN			
C 0.16	Contact input signal 1 type	ALT			
C 0.17	Contact input signal 1 delay timer (time delay) of reading	---- (0)*8			
C 0.18	Contact input signal 1 OFF detection timer	---- (0)*8			
C 0.19	Contact input signal 2	OFF			
C 0.20	Contact input signal 2 type	ALT			
C 0.21	Contact input signal 2 delay timer (time delay) of reading	---- (0)*8			
C 0.22	Contact input signal 2 OFF detection timer	---- (0)*8			
C 0.23	Contact output signal 1 function	RUN			
C 0.24	Contact output signal 1 operation	A			
C 0.25	Contact output signal 1 selected alarm	---- (AL.01) *8			
C 0.26	Contact output signal 2 function	RMT			
C 0.27	Contact output signal 2 operation	A			
C 0.28	Contact output signal 2 selected alarm	---- (AL.01) *8			
C 0.29	Contact output signal 3 function	ALM			
C 0.30	Contact output signal 3 operation	B			
C 0.31	Contact output signal 3 selected alarm	---- (AL.01) *8			

*8: Regarding the detail of the default setting, refer to “5.21Communication function”.

5.3 Main screen

5.3.1 Main screen

Displays the current temperature and the set temperature of the circulating fluid. The set temperature can be changed on this screen.

5.3.2 Display on the main screen

The display on the main screen is as follows.

Current discharge temperature of circulating fluid Display

1. Turn ON the power supply.

Current temperature and set temperature are displayed on the digital display.

Alarm display screen (See 5.4) appears when an alarm is generated.

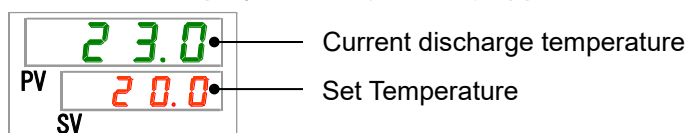

[Tips]

This digital display appears by pressing [MENU] on the display showing each menu items.

Circulating fluid temperature Set

2. Change the set temperature by pressing the [▼][▲] key.

After changing the set temperature, set it by pressing the [SEL] key.

*The set value flashes while it is being changed.

*If [SEL] key is not pressed, the value is reset after 3 sec.

Circulating fluid discharge pressure Display

3. Press the [SEL] key.

The discharge pressure of the circulating fluid is displayed on the digital display.

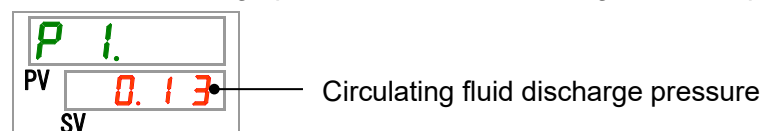

5.4 Alarm display menu

5.4.1 Alarm display menu

The alarm display screen appears when an alarm is generated.

- * The alarm display menu cannot be accessed when no alarm has been generated.
- * Refer to “Chapter 7 Alarm indication and trouble shooting” for the content of alarms.

5.4.2 Content of display of alarm display menu

The alarm display screen appears when an alarm is generated.

When multiple alarms are generated, the latest alarm is displayed on the screen.

Each time the [SEL] key is pressed, the alarms are displayed in order, starting from the latest one.

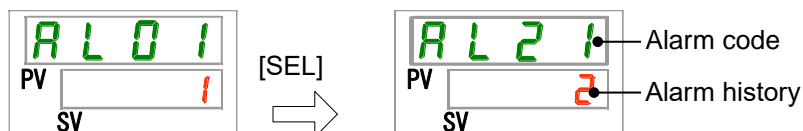

The main screen is displayed when the alarm is reset.



The main screen is displayed when [MENU] key is pressed while an alarm is output.



The alarm display screen is displayed if [MENU] key is pressed again.

5.5 Inspection monitor menu

5.5.1 Inspection monitor menu

As a part of the daily inspection, the temperature, pressure and accumulated operating time can be checked.

Please use this for confirmation of your daily inspection.

5.5.2 Checking of the Inspection monitor menu

The table below explains the check items of the inspection monitor menu.

Table 5.5-1 List of check items of Inspection monitor menu

Display	Item	Content
E 1.	Circulating fluid discharge temperature	Displays the temperature of the circulating fluid discharge. This temperature does not take offset into consideration.
E 2.	Circulating fluid return port temperature	Displays the temperature of the circulating fluid return.
E 3.	Temperature of the inlet of the compressor	Displays the temperature of the inlet of the compressor.
P 1.	Circulating fluid discharge pressure	Displays the circulating fluid discharge pressure at the discharge.
P h.	Pressure of higher pressure refrigerant circuit	Displays the pressure of higher pressure side of the refrigerant circuit.
P L.	Pressure of lower pressure refrigerant circuit	Displays the pressure of lower pressure side of the refrigerant circuit.
- - - -	Unused	-
P U n P	Accumulated operation time of the pump	Displays the accumulated operation time of the pump.
F A n n	Accumulated operation time of the fan	Displays the accumulated operation time of the fan motor. (For air cooled type)
r E F.	Accumulated operation time of the compressor	Displays the accumulated operation time of the compressor.
d r u.	Accumulated operation time	Displays the accumulated operation time.
F I L E.	Accumulated operation time of the dust-proof filter	Displays the accumulated operation time of the dust proof filter.
F L o H	Circulating fluid flow rate	Displays the circulating fluid flow rate. This is not measurement value. Please use for reference.

Check of the circulating fluid discharge temperature

1. Press and hold the [MENU] key for approx. 2 sec.

The temperature of the circulating fluid discharge 「E 1.」 is displayed on the digital display.

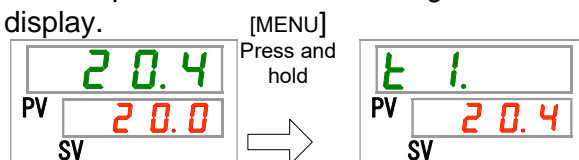

Displays the temperature of the circulating fluid at the discharge from which the fluid is fed to the customer's device. This temperature does not take temperature offset into consideration

Check of the circulating fluid inlet temperature

2. Press the [SEL] key once.

The temperature of the circulating fluid return is displayed on the digital display.

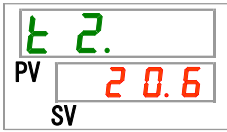

Displays the temperature of the circulating fluid returning from the customer's device.

Check of the temperature of the inlet of the compressor.

3. Press the [SEL] key once.

The temperature of the refrigerant circuit compressor inlet is displayed on the digital display.

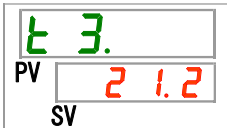

Displays the temperature of the compressor inlet.

Check of the circulating fluid discharge pressure

4. Press the [SEL] key once.

The circulating fluid discharge pressure is displayed on the digital display.

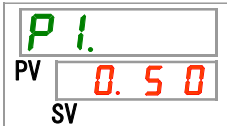

The pressure of the circulating fluid discharge from which the fluid is sent to the customer's device is displayed.

Check of the pressure of the higher pressure side of the refrigerant circuit

5. Press the [SEL] key once.

The pressure of higher pressure refrigerant circuit is displayed on the digital display.

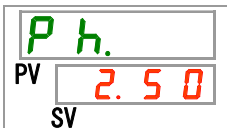

Displays the pressure of the higher pressure side of the refrigerant circuit.

Check of the pressure of the lower pressure side of the refrigerant circuit

6. Press the [SEL] key once.

The pressure of lower pressure refrigerant circuit is displayed on the digital display.

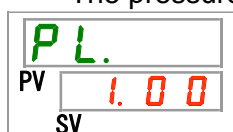

Displays the pressure of the lower pressure side of the refrigerant circuit.

7. Press the [SEL] key once.

"- - - -" is displayed on the digital display.

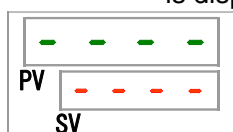

Not used in this product.

Check of the accumulated operation time of the pump

8. Press the [SEL] key once.

The accumulated operation time of the pump is displayed on the digital display.

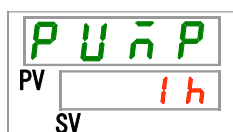

Displays the accumulated operation time of the pump. Refer to the table below for the display.

Table 5.5-2 List of time display

Cumulative time	Indicated value
0h to 999h	<input type="text" value="0h"/> to <input type="text" value="999h"/>
1,000h to 99,999h	<input type="text" value="1hh"/> to <input type="text" value="99hh"/>
100,000h	Return to <input type="text" value="0h"/>

AL28 Pump maintenance alarm is generated when the accumulated operation time of the pump reaches 20,000 hours () or more. For details, refer to Chapter 7 Alarm indication and trouble shooting.

Check of the accumulated operation time of the fan

9. Press the [SEL] key once.

The accumulated operation time of the fan is displayed on the digital display.

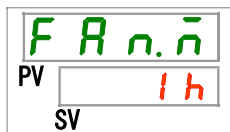

Displays the accumulated operation time of the fan. Refer to Table 5.5-2 for the display.

AL29 Fan maintenance alarm is generated when the accumulated operation time of the fan motor reaches 30,000 hours (**30 h h**) or more. For details, refer to Chapter 7 Alarm indication and trouble shooting.

Check of the accumulated operation time of the compressor

10. Press the [SEL] key once.

The accumulated operation time of the compressor is displayed on the digital display.



Displays the accumulated operation time of the compressor. Refer to Table 5.5-2 for the display.

AL30 Compressor maintenance alarm is generated when the accumulated operation time of the compressor reaches 30,000 hours (**30 h h**) or more. For details, refer to Chapter 7 Alarm indication and trouble shooting.

Check of the accumulated operation time

11. Press the [SEL] key once.

The accumulated operation time is displayed on the digital display.

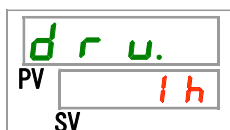

Displays the accumulated operation time. Refer to Table 5.5-2 for the display.

Check of the accumulated operation time

12. Press the [SEL] key once.

The accumulated operation time of the dust-proof filter is displayed on the digital display.



Displays the accumulated operation time of the dust-proof filter. Refer to Table 5.5-2 for the display.

AL40 dust-proof filter maintenance alarm is generated when the accumulated operation time of the dust-proof filter reaches set time or more. For details, refer to Chapter 7 Alarm indication and trouble shooting.

Check of circulating fluid flow rate

13. Press the [SEL] key once.

The circulating fluid flow rate is displayed on the digital display.

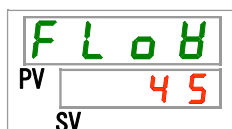

The circulating fluid flow rate of the product as a guide is displayed. Display unit is L/min. This is not measurement value. Please use for reference.

5.6 Key-lock

5.6.1 Key-lock

The keys can be locked to prevent the set values being changed by operator error. Operation can be started/stopped by the "RUN/STOP" key even while key-lock is set.

If you try to change the set value with "▲" and "▼" key while key-lock is set, "LoCk" is displayed for 1 sec. on the screen. The set value cannot be changed. (Refer to the figure below.)

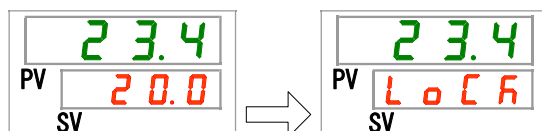

⚠ CAUTION



During key-lock setting, no other setting is available.
Release the key-lock setting for other setting.

5.6.2 Key-lock setting / checking

The table below explains the setting items of the key-lock function and the initial values.

Table 5.6-1 List of key-lock

Display	Item	Contents	Initial value (Default setting)
	Key-lock	Sets key-lock. While key-lock setting is ON, no other setting is available.	OFF

1. Press and hold the [MENU] key for approx. 2 sec.

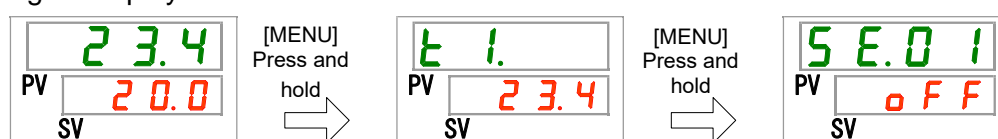

Repeat pressing until the setting display [] for key-lock setting appears on the digital display



Key-lock setting and checking

2. Select "ON" from the table below with [] key or [] key, and confirm with "SEL".

Table 5.6-2 List of set value

Set value	Explanation	Initial value (Default setting)
	Key-lock function OFF	0
	Key-lock function ON	

3. Press the [MENU] key once.

Return to the main screen (screen displaying the circulating fluid temperature).

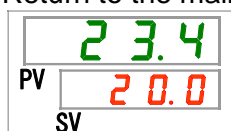

5.7 Run timer, stop timer function

5.7.1 Run timer and stop timer function

This function starts or stops operation automatically when a set time has passed. The time can be set according to the customer's working hours. Set the circulating fluid temperature in advance.

[Run timer] is a function to start operation after a set time. Stop timer] is a function to stop operation after a set time. It is possible to set both [Run timer] and [Stop timer]. The set time of both the [Run timer] and [Stop timer] can be up to 99.5 hours, in 0.5 hour units.

【When communication is used】

If the communication mode is DIO REMOTE, SERIAL mode, this function does not operate. DIO REMOTE, SERIAL mode operation/stop signal has priority.

●Run timer

- Run timer] starts operation after the set time.

If the thermo-chiller is already operating or the pump is operating independently, this function does not operate even if the set time has passed.

Operation can start when the condition is normal and there is no alarm generated.

- The [⊕] lamp lights up when the run timer is set. The [⊖] lamp is turned off when the operation is started by the run timer.

The [⊕] lamp is not turned off if the Stop timer is set.

- The Run timer setting is reset when the main power supply is cut or a power failure occurs. Please reset.

●Stop timer

- The [⊖] lamp lights when the Stop timer is set. The [⊕] lamp is turned off if the operation is stopped by the Stop timer.

The [⊖] lamp is not turned off if the Run timer is set.

- The Stop timer setting is reset when the main power supply is cut or a power failure occurs. Please reset.

Timer setting example

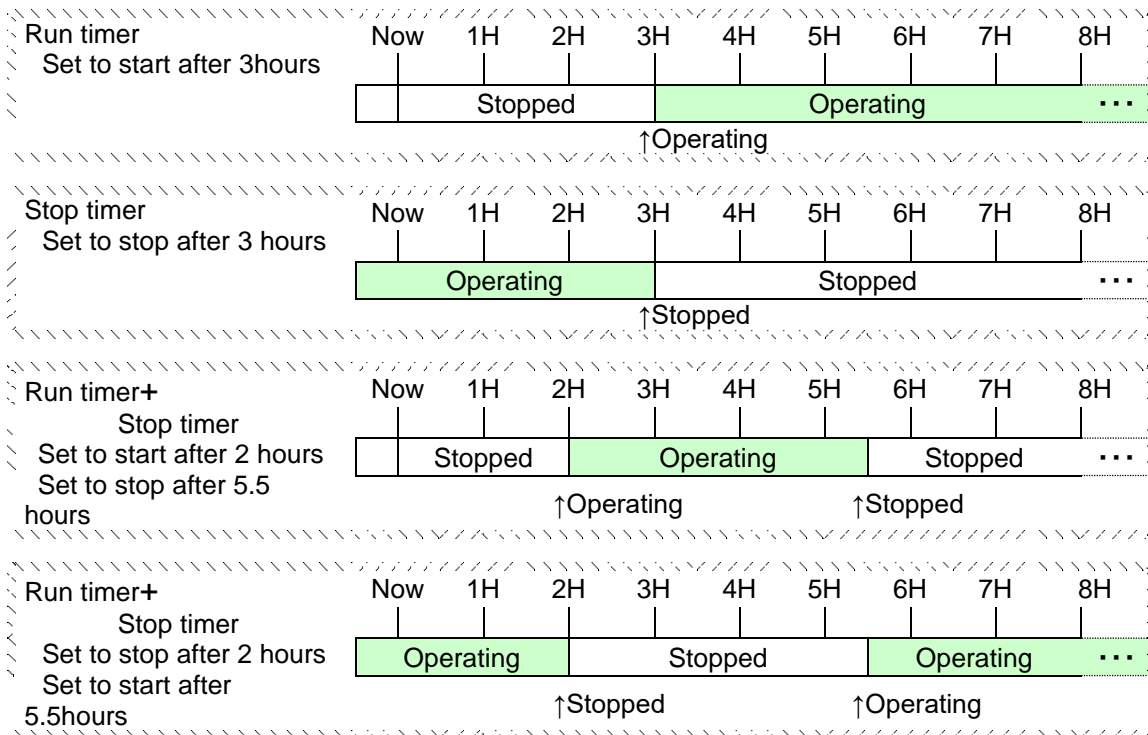

⚠ CAUTION

- **Set while the breaker is ON (while the power is supplied).**
- **The setting is released when operation is started or stopped by the timer. Resetting is necessary to use the timer next time.**
- **Run timer setting is released when the breaker or the customer's power supply facility is cut, or a power failure occurs. Please reset.**

5.7.2 Setting and checking of Run timer and stop timer function

The table below explains the setting items of the run/stop timer and the initial values.

Table 5.7-1 List of set run timer and stop timer

Display	Item	Contents	Initial value (Default setting)
SE.02	Run timer	Sets run timer.	0.0H
SE.03	Stop timer	Sets stop timer.	0.0H

This part explains the setting and checking items of both the run and stop timers. Please refer to the applicable items for the timer you wish to use.

1. Press and hold the [MENU] key for approx. 2 sec.

Repeat pressing the key until the setting screen for key-lock [SE.01] appears on the digital display.

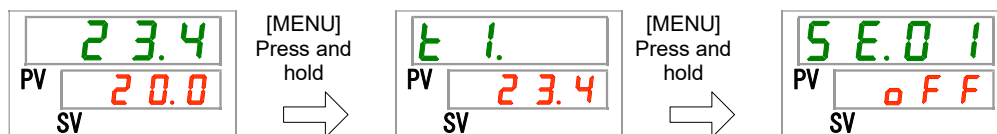

Run timer Setting and checking

2. Press the [SEL] key once.

The set screen of run timer is displayed on the digital display.



3. Set the run timer as the table below with [▲] key or [▼] key, and confirm by pressing "SEL".

Table 5.7-2 List of set value

Set value	Explanation	Initial value (Default setting)
0.0 h	Timer OFF	0
0.5 h to 99.5 h	Operation starts after set time. Setting unit is 0.5 hour	

E.g. Set at 5:30pm the previous day. Operation starts 14 hours later (7:30am the next day).



Stop timer Setting and checking

- 4.** Press the [SEL] key once.

The set screen of stop timer is displayed on the digital display.



- 5.** Set stop timer as the table below with [▲] key or [▼] key, and confirm by pressing "SEL".

Table 5.7-3 List of set value

Set value	Explanation	Initial value (Default setting)
0.0 h	Timer OFF	0
0.5 h to 99.5 h	Operation stops after set time. Setting unit is 0.5 hour	

E.g. Set at 4:30pm. Operation stops 1 hour and 30 minutes later (at 6:00pm).



- 6.** Press the [MENU] key once.

Return to the screen displaying the circulating fluid temperature.

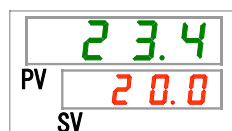

- 7.** Once the run timer is set leave the power supply to the product on. The product will start automatically in the set time.

When the stop timer is set, leave the product running. The product will stop automatically in the set time.

5.8 Ready completion (TEMP READY) signal

5.8.1 Ready completion (TEMP READY) signal

This function sets the band width for the circulating fluid set temperature (upper/lower temperature range) in order to notify the customer by communication that the circulating fluid temperature has reached the band range (upper/lower temperature range). The default setting of this function is "OFF".

[Tips]

This function is available when contact input/output and serial communication is used. Refer to the Communications Operation Manual for more details.

An example is shown below.

Circulating fluid set temperature	: 20 °C
READY band width (upper/lower temperature range)	: ±2 °C
READY time	: 60 sec.

To be ready is completed 60 seconds after the circulating fluid temperature reaches 18°C to 22°C.

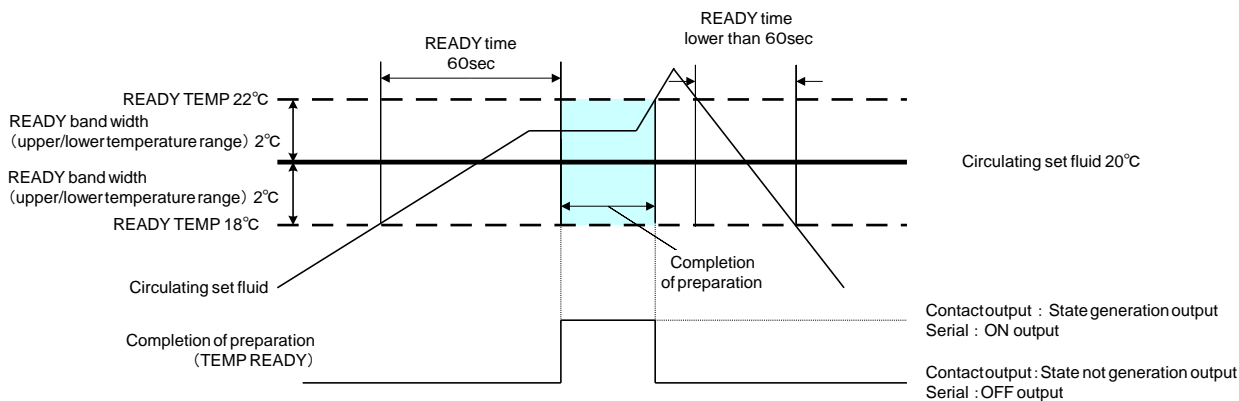

5.8.2 Ready completion (TEMP READY) signal setting / checking

The table below shows the explanation of and initial value of set items of ready completion (TEMP. READY) signal

Table 5.8-1 List of set Signal for completion of preparation (TEMP READY)

Display	Item	Content	Initial value (Default setting)
SE.04	READY mode	Sets ready completion (TEMP READY) signal	OFF
SE.05	READY band width (upper/lower temperature range)	Sets temperature of ready completion (TEMP READY) signal.	----
SE.06	READY time	Sets time of ready completion (TEMP READY) signal	----

1. Press and hold the [MENU] key for approx. 2 sec.

Repeat pressing the key until the setting screen for key-lock [SE.01] appears on the digital display.

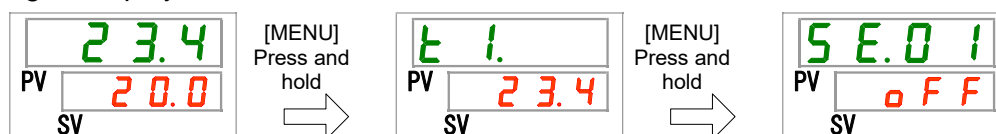

READY mode Setting and checking

2. Press the [SEL] key 3 times.

The set screen of ready mode is displayed on the digital display.

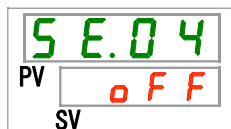

3. Select 「ON」 from the table below with [▲] key or [▼] key, and confirm by pressing “SEL”.

Table 5.8-2 List of set value

Set value	Explanation	Initial (Default setting)
OFF	ready completion (TEMP READY) signal is OFF	O
ON	ready completion (TEMP READY) signal is ON	

READY band width setting and checking

4. Press the [SEL] key once.

The set screen of READY band width (upper/lower temperature range) is displayed on the digital display.



5. Select READY band width (upper/lower temperature range) from the table below with [▲] key or [▼] key, and confirm by pressing “SEL”.

Table 5.8-3 List of set value

Set value	Explanation	Initial (Default setting)
----	Setting and checking are not available when READY mode setting is OFF.	
Centigrade 0.0 to 5.0	Set READY band width (upper/lower temperature range) for the circulating fluid temperature	0.0
Fahrenheit 0.0 to 9.0	Temperature unit is Centigrade : Setting unit is 0.1°C Temperature unit is Fahrenheit : Setting unit is 0.1°F	0.0

READY time Set and checking

6. Press the [SEL] key once.

The set screen of READY time is displayed on the digital display.



7. Set READY time as the table below with [▲] key or [▼] key, and confirm by pressing “SEL”.

Table 5.8-4 List of set value

Set value	Explanation	Initial value (Default setting)
----	Setting and checking are not available when READY mode setting is OFF.	
1 0 to 9 9 9 9	Sets ultimate time. Set unit is 1 sec.	1 0

8. Press the [MENU] key once.

Return to the main screen (screen displaying the circulating fluid temperature).

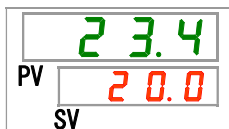

5.9 Offset function

5.9.1 Offset function

This function controls the circulating fluid discharge temperature with offset.

Temperature offset may occur between the thermo-chiller and the customer's device depending on the installation environment. To correct the temperature offset, three types of offset functions are available (MODE1 to 3). The default setting of this function is "OFF".

【When communication is used】

The circulating fluid temperature sent by serial communication is the circulating fluid temperature which is displayed on the thermo-chiller (the circulating fluid temperature after offset).

●Example of temperature offset

The discharge temperature of the circulating fluid is 30°C, but the fluid temperature in the customer's device is 29°C because of heat radiation during sending of the fluid.

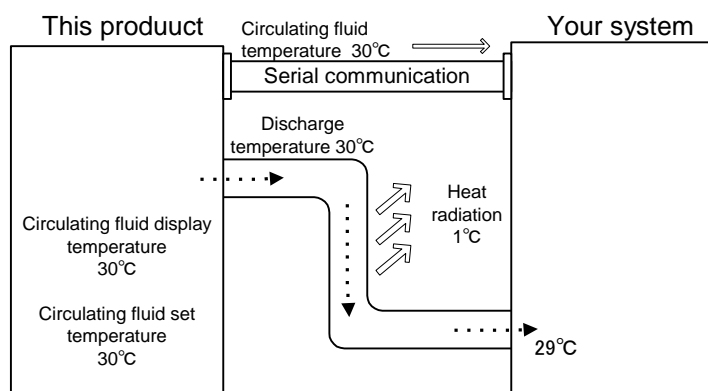

MODE	Explanation
MODE1	Control the temperature so that the discharge temperature of the circulating fluid is circulating fluid set temperature + offset temperature. Circulating fluid temperature indicates the circulating fluid discharge temperature.
MODE2	Control the temperature so that the discharge temperature of the circulating fluid is circulating fluid set temperature. Circulating fluid temperature indicates the circulating fluid discharge temperature + offset temperature.
MODE3	Control the temperature so that the discharge temperature of the circulating fluid is circulating fluid set temperature + offset temperature. Circulating fluid temperature indicates the circulating fluid discharge temperature - offset temperature.
OFF	Control the temperature so that the discharge temperature of the circulating fluid is circulating fluid temperature set value.

■ Example of MODE 1

When the offset temperature is 1°C, the thermo-chiller controls the temperature aiming at 31°C (circulating fluid set temperature + offset temperature.) Even if the discharge temperature is 31°C, the circulating fluid temperature is 30°C at the customer's device because of 1°C of heat radiation during sending of the fluid. Circulating fluid display temperature and communication data is 31°C.

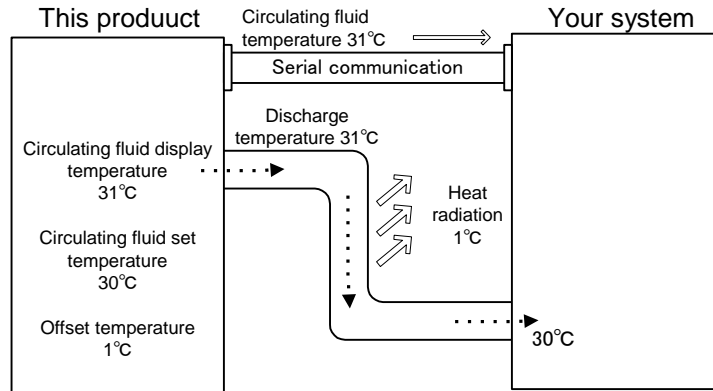

■ Example of MODE 2

When the offset temperature is -1°C, circulating fluid display temperature and the communication data is 29°C (circulating fluid discharge temperature + offset temperature), and matches the circulating fluid temperature of the customer's device.

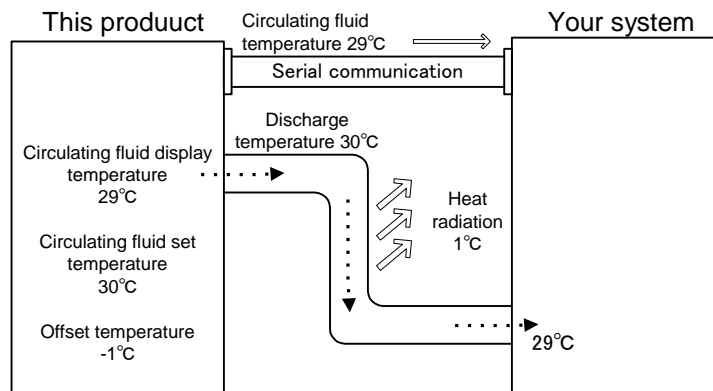

■ Example of MODE 3

When the offset temperature is 1°C, the thermo-chiller controls the temperature aiming at 31°C (circulating fluid set temperature + offset temperature) Even if the discharge temperature is 31°C, the circulating fluid temperature is 30°C at the customer's device because of 1°C of heat radiation during sending of the fluid. The circulating fluid display temperature and the communication data is 30°C (circulating fluid discharge temp. - offset temp.), and matches the circulating fluid temperature of the customer's device.

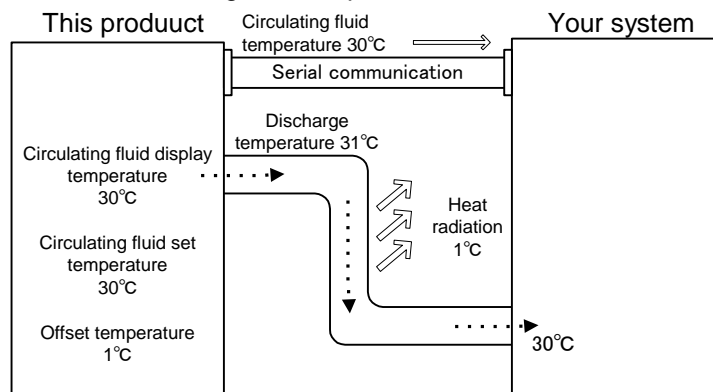

5.9.2 Offset function setting and checking

The table below explains the setting items of the offset function and the initial values.

Table 5.9-1 List of set offset function

Display	Item	Contents	Initial (Default setting)
SE07	Offset mode	Sets offset mode.	OFF
SE08	Offset temperature	Sets offset temperature.	0.0 °C

1. Press and hold the [MENU] key for approx. 2 sec.

Repeat pressing the key until the setting screen for key-lock [SE01] appears on the digital display.

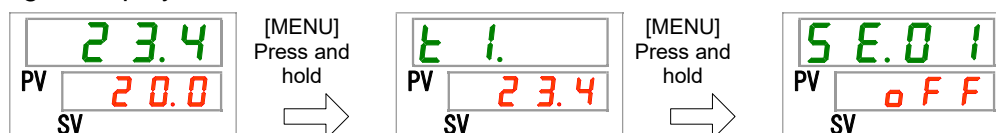

Offset mode Setting and checking

2. Press the [SEL] key 6 times.

The set screen of offset mode is displayed on the digital display.



3. Select offset mode from the table below with [▲] key or [▼] key, and confirm by pressing "SEL".

Table 5.9-2 List of set value

Set value	Explanation	Initial value (Default setting)
0FF	Offset function OFF	0
n d 1	Offset mode 1	
n d 2	Offset mode 2	
n d 3	Offset mode 3	

Offset temperature Setting and checking

4. Press the [SEL] key once.

The set screen of offset temperature is displayed on the digital display.



5. Select offset temperature from the table below with [▲] key or [▼] key, and confirm by pressing "SEL".

Table 5.9-3 List of set value

Set value	Explanation	Initial (Default setting)
----	Setting and checking are not available when offset mode setting is OFF.	
Centigrade - 20.0 to 20.0	Sets offset temperature. Temperature unit is Centigrade : Setting unit is 0.1°C	0.0
Fahrenheit - 36.0 to 36.0	Temperature unit is Fahrenheit : Setting unit is 0.1°F	0.0

CAUTION



- This function controls the offset temperature to the circulating fluid discharge temperature
- Control range of the circulating fluid temperature is 5.0 °C to 40.0 °C (41.0°F to 104.0°F).
- When the circulating fluid temperature is set to 5.0°C (41°F) and the offset temperature to -20.0°C (-36.0°F), the offset temperature is automatically adjusted to 0.0 °C (0.0°F) depending on the offset mode.

6. Press the [MENU] key once.

Return to the main screen (screen displaying the circulating fluid temperature).

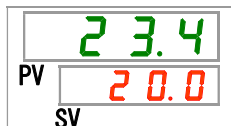

5.10 Function to recover from power failure

5.10.1 Function to recover from power failure

When the power supply is cut due to power failure etc., this function restarts the operation when the power supply recovers, retaining the conditions before the power cut.

【When communication is used】

If the communication mode is DIO REMOTE, SERIAL mode (MODBUS), this function does not start. The signal of start/stop of DIO REMOTE SERIAL mode (MODBUS) has priority.

The [Ⓢ] lamp lights when the power failure recovery is set. The default setting of this function is "OFF".

When the recovery function in case of power failure is OFF, Alarm AL41 "Power stoppage" is not generated.

5.10.2 Function to recover from power failure setting and checking

The table below explains the setting items of the power recovery function and the initial values.

Table 5.10-1 List of set function to recover from power failure

Display	Item	Contents	Initial value (Default setting)
SE.09	Recover from power failure	Sets recover from power failure.	OFF

1. Press and hold the [MENU] key for approx. 2 sec.

Repeat pressing the key until the setting screen for key-lock [SE.01] appears on the digital display.

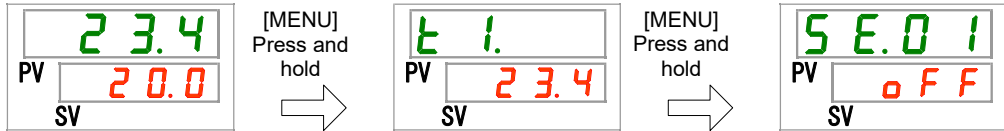

Recover from power failure Setting and checking

2. Press the [SEL] key 8 times.

The set screen of recover from power failure is displayed on the digital display.

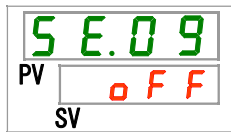

3. Select recover from power failure from the table below with [▲] key or [▼] key, and confirm by pressing "SEL".

Table 5.10-2 List of set value

Set value	Explanation	Initial value (Default setting)
OFF	Function to recover from power failure OFF	0
ON	Function to recover from power failure ON	

4. Press the [MENU] key once.

Return to the main screen (screen displaying the circulating fluid temperature).

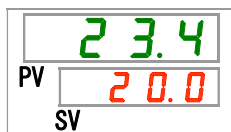

5.11 Anti-freezing function

5.11.1 Anti-freezing function

CAUTION



The power supply should be ON for this function. Otherwise this function cannot start.

To prevent the circulating fluid freezing during winter, this function operates pump automatically to heat the circulating fluid by the pump's heat radiation while the product's operation is stopping. If there is a possibility of the circulating fluid freezing due to changes in the installation and operating environment (season and weather), set this function in advance.

- If the circulating fluid temperature falls below 3°C, the pump will start operating automatically.
- The heat generated by the pump operation will warm up the circulating fluid.
When the circulating fluid temperature reaches 5°C or higher, the pump will stop operating automatically.
- As a result, the circulating fluid maintains a temperature of between 3°C and 5°C, preventing freezing.

When the anti-freezing function is set, [RUN] lamp blinks every 2 sec. during waiting (pump does not operate). The [RUN] lamp blinks every 0.3sec. during the automatic operation of the pump. The default setting of this function is "OFF".

When the warming up function is "ON" (refer to "5.18 Warming up function"), the warming up function will be prioritized higher than the anti-freezing function and anti-freezing function does not start.

CAUTION



- This function can be used only while the power supply is ON and the operation is stopping.
- Fully open the valve or manual bypass valve arranged by the customer so that the circulating fluid can circulate when the pump starts automatic operation.
- In extremely cold weather conditions, the heat generated by the pump as described above may not be enough to prevent freezing.
- During the automatic operation, the pump does not stop even if you press "RUN/STOP" key. To stop the pump, shut off the power or make this function "OFF".

5.11.2 Anti-freezing function setting and checking

The table below explains the setting items of the anti-freezing function and the initial values.

Table 5.11-1 List of set anti-freezing function

Display	Item	Contents	Initial value (Default setting)
SE.10	Anti-freezing function	Sets anti-freezing	OFF

1. Press and hold the [MENU] key for approx. 2 sec.

Repeat pressing the key until the setting screen for key-lock [SE.01] appears on the digital display.

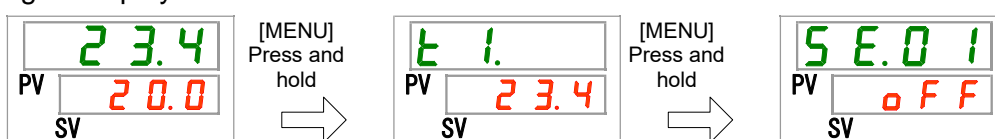

Anti-freezing function Setting and checking

2. Press the [SEL] key 9 times.

The set screen of anti-freezing function is displayed on the digital display.

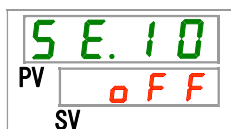

3. Select anti-freezing function from the table below with [▲] key or [▼] key, and confirm by pressing “SEL”.

Table 5.11-2 List of set value

Set value	Explanation	Initial value (Default setting)
OFF	Anti-freezing function OFF	0
ON	Anti-freezing function ON	

4. Press the [MENU] key once.

Return to the main screen (screen displaying the circulating fluid temperature).

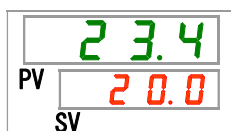

5.12 Key click sound setting

5.12.1 Key click sound setting

Set whether or not a click sound is made when keys on the operation panel are pressed.

The default setting is key sound "on".

5.12.2 Key click sound setting and checking

The table below explains the setting items of the key click sound and the initial values.

Table 5.12-1 List of set key click sound

Display	Item	Contents	Initial value (Default setting)
SE.II	Key click sound	Sets key click sound.	ON

1. Press and hold the [MENU] key for approx. 2 sec.

Repeat pressing the key until the setting screen for key-lock [SE.OI] appears on the digital display.

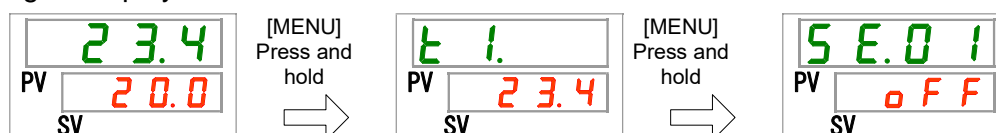

Key click sound Setting and checking

2. Press the [SEL] key 10 times.

The set screen of key click sound is displayed on the digital display.

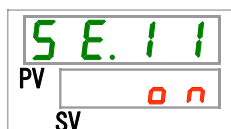

3. Select key click sound from the table below with [▲] key or [▼] key, and confirm by pressing "SEL".

Table 5.12-2 List of set value

Set value	Explanation	Initial value (Default setting)
0FF	No key click sound	
0n	Key click sounds	0

4. Press the [MENU] key once.

Return to the main screen (screen displaying the circulating fluid temperature).

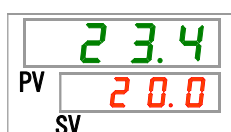

5.13 Temperature unit switching

5.13.1 Temperature unit switching

The temperature unit of the thermo-chiller can be set to centigrade (°C) or Fahrenheit (°F). This setting determines the temperature unit which is displayed/output. The default setting is centigrade (°C).

-This feature is not valid with Option W, the unit is fixed at centigrade (°C).

5.13.2 Temperature unit switching setting and checking

The table below explains the setting items of the temperature unit switching and the initial values.

Table 5.13-1 List of set temperature unit switching

Display	Item	Contents	Initial value (Default setting)
5 E.12	Temperature unit	Sets temperature unit.	°C

1. Press and hold the [MENU] key for approx. 2 sec.

Repeat pressing the key until the setting screen for key-lock [5 E.01] appears on the digital display.

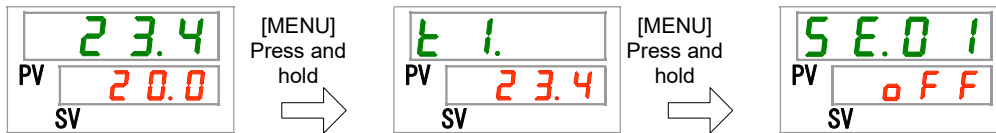

Temperature unit Setting and checking

2. Press the [SEL] key 11 times.

The set screen of temperature unit is displayed on the digital display.

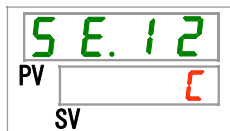

3. Select temperature unit from the table below with [▲] key or [▼] key, and confirm by pressing "SEL".

Table 5.13-2 List of set value

Set value	Explanation	Initial value (Default setting)
E	Sets temperature unit is centigrade (°C).	0
F	Sets temperature unit is fahrenheit (°F)	

4. Press the [MENU] key once.

Return to the main screen (screen displaying the circulating fluid temperature).

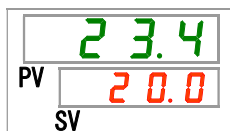

5.14 Pressure unit switching

5.14.1 Pressure unit switching

The pressure unit of the thermo-chiller can be set to MPa or PSI. This setting determines the pressure unit which is displayed/output. The default setting is MPa.

-This feature is not valid with Option W, the unit is fixed at MPa.

5.14.2 Pressure unit switching setting and checking

The table below explains the setting items of the pressure unit switching and the initial values.

Table 5.14-1 List of set Pressure unit switching

Display	Item	Contents	Initial value (Default setting)
5 E. 13	Pressure unit	Sets pressure unit.	MPa

1. Press and hold the [MENU] key for approx. 2 sec.

Repeat pressing the key until the setting screen for key-lock [5 E. 0 1] appears on the digital display.

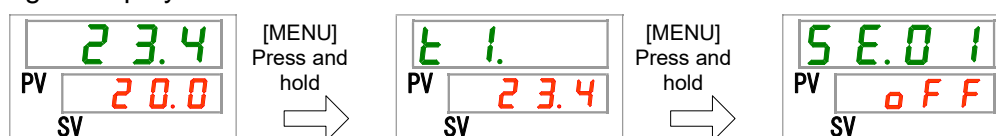

pressure unit Setting and checking

2. Press the [SEL] key 12 times.

The set screen of pressure unit is displayed on the digital display.

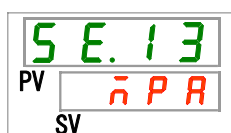

3. Select pressure unit from the table below with [▲] key or [▼] key, and confirm by pressing "SEL".

Table 5.14-2 List of set value

Set value	Explanation	Initial value (Default setting)
n P A	Sets pressure unit is MPa.	0
P S I	Sets pressure unit is PSI.	

4. Press the [MENU] key once.

Return to the main screen (screen displaying the circulating fluid temperature).

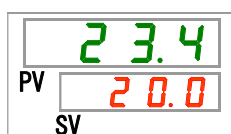

5.15 Data reset function

5.15.1 Data reset function

Values set by customer are reset to default values. Accumulated operating time is not reset.

⚠ CAUTION

**All setting values are reset.
It is recommended to record set data before reset.**

5.15.2 Method of resetting data reset function

The table below explains the setting items of the data reset and the initial values.

Table 5.15-1 List of data reset

Display	Item	Contents	Initial value (Default setting)
SE.14	Data reset	All data is reset. (Accumulated operation time is not reset.)	NO

1. Press and hold the [MENU] key for approx. 2 sec.

Repeat pressing the key until the setting screen for key-lock [SE.01] appears on the digital display.

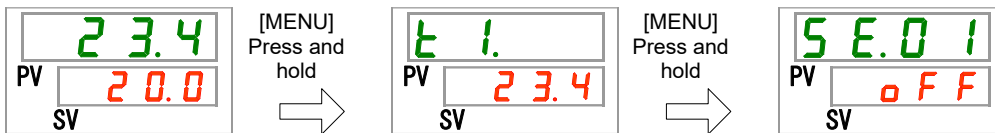

Data reset

2. Press the [SEL] key 13 times.

The set screen of data reset is displayed on the digital display.

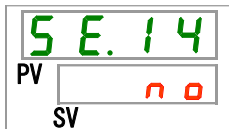

3. Select YES from the table below with [▲] key or [▼] key, and confirm by pressing "SEL". Select YES, then all data returns to default setting. The display returns to the main screen.

Table 5.15-2 List of set value

Set value	Explanation	Initial value (Default setting)
n o	Not reset	0
y e s	All data is reset	

5.16 Accumulated time reset function

5.16.1 Accumulated time reset function

The alarms below are generated to notify the maintenance time.
The product is not stopped for alarm.

- Pump maintenance (AL28): Generated after 20,000h of accumulated operating time
- Fan motor maintenance (AL29) : Generated after 30,000h of accumulated operating time.
- Compressor maintenance (AL30): Generated after 30,000h of accumulated operating time
- Dust-proof filter maintenance (AL40): Generated after set time.

To reset the alarm, reset the accumulated operating time.
Reset the accumulated time after the replacement of parts (call for inspection service).

* Time for Dust-proof filter maintenance (AL40) can be set within 1 to 9999h.
Refer to 5.20.2 Alarm customize function setting and checking for details.

5.16.2 Method of resetting accumulated time reset function

The table below explains the setting items of the accumulated time reset and the initial values.

Table 5.16-1 List of set accumulated time reset function

Display	Item	Content	Initial value (Default setting)
SE.15	Pump accumulated operating time reset	Reset the accumulated operating time of the pump.	NO
SE.16	Fan accumulated operating time reset	Reset the accumulated operating time of the fan.	NO
SE.17	Compressor accumulated operating time reset	Reset the accumulated operating time of the compressor.	NO
SE.30	Dust-proof filter accumulated operating time reset	Reset the accumulated operating time of the dust-proof filter.	NO

Refer to each paragraph for the detail of resetting the accumulated operating time.

Pump accumulated operating time reset

1. Press and hold the [MENU] key for approx. 2 sec.

Repeat pressing the key until the setting screen for key-lock [SE.01] appears on the digital display.

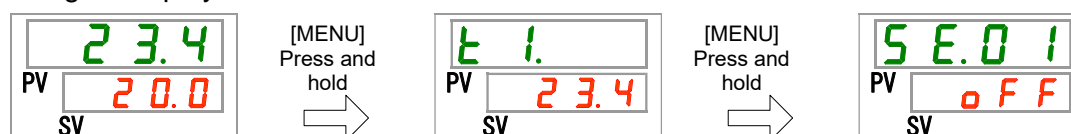

2. Press the [SEL] key 14 times.

The set screen of pump accumulated operating time reset is displayed on the digital display.

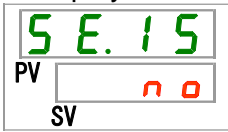

3. Select YES from the table below with [▲] key or [▼] key, and confirm by pressing "SEL". Select YES, then the accumulated operating time of the pump is reset. The display returns to the main menu.

Table 5.16-2 List of set value

Set value	Explanation	Initial value (Default setting)
<input type="checkbox"/> no	Not reset	0
<input checked="" type="checkbox"/> YES	Pump accumulated operating time is reset	

Fan accumulated operating time reset

4. Press and hold the [MENU] key for approx. 2 sec.

Repeat pressing the key until the setting screen for key-lock [SE.01] appears on the digital display.

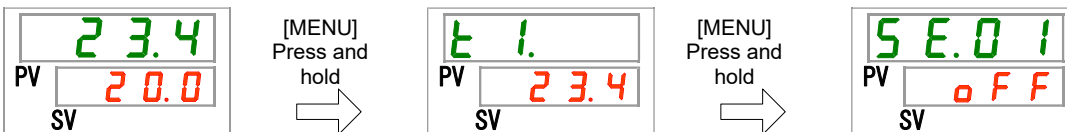

5. Press the [SEL] key 15 times.

The set screen of fan accumulated operating time reset is displayed on the digital display.

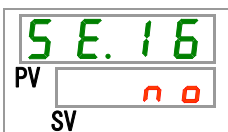

6. Select YES from the table below with [▲] key or [▼] key, and confirm by pressing "SEL". Select YES, then the accumulated operating time of the fan is reset. The display returns to the main menu.

Table 5.16-3 List of set value

Set value	Explanation	Initial value (Default setting)
<input type="checkbox"/> no	Not reset	0
<input checked="" type="checkbox"/> YES	Fan accumulated operating time is reset	

Compressor accumulated operating time reset

7. Press and hold the [MENU] key for approx. 2 sec.

Repeat pressing the key until the setting screen for key-lock [**SE.01**] appears on the digital display.

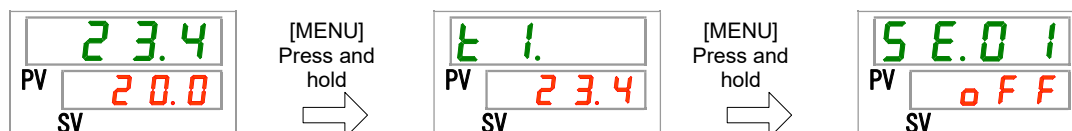
**8.** Press the [SEL] key 16 times.

The set screen of compressor accumulated operating time reset is displayed on the digital display.

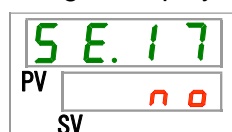

9. Select **YES** from the table below with [▲] key or [▼] key, and confirm by pressing "SEL". Select **YES**, then the accumulated operating time of the compressor is reset. The display returns to the main menu.

Table 5.16-4 List of set value

Set value	Explanation	Initial value (Default setting)
n0	Not reset	0
YES	Compressor accumulated operating time is reset	

Dust-proof filter accumulated operating time reset

10. Press and hold the [MENU] key for approx. 2 sec.

Repeat pressing the key until the setting screen for key-lock [**SE.01**] appears on the digital display.

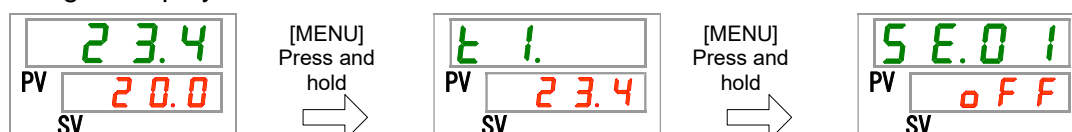
**11.** Press the [SEL] key 29 times.

The set screen of dust-proof filter accumulated operating time reset is displayed on the digital display.



12. Select from the table below with [▲] key or [▼] key, and confirm by pressing "SEL". Select , then the accumulated operating time of the dust-proof filter is reset. The display returns to the main menu.

Table 5.16-5 List of set value

Set value	Explanation	Initial value (Default setting)
<input type="text" value="no"/>	Not reset	0
<input type="text" value="YES"/>	Dust-proof filter accumulated operating time is reset	

5.17 Pump operation mode function

5.17.1 Pump operation mode

The product can be set the pump operation mode as follows below.

● Pressure controlled mode

The pump of the product operates so that the circulating fluid discharge pressure becomes the set pressure automatically.

If the connected piping's resistance is small, there is a possibility that the actual pressure does not rise to the set pressure. In this case, the pressure cannot rise due to the small piping resistance even though the pump discharges the maximum flow. This situation is not malfunction of the product.

If the connected piping's resistance is large, there is a possibility that the actual pressure does not lower to the set pressure. In this case, the pressure cannot lower due to the large piping resistance even though the pump discharges the minimum flow. This situation is not malfunction of the product.

● Frequency set mode

The pump of the product is operated according to the set pump operation frequency.

If the pressure control mode is not necessary, use this mode.

5.17.2 How to check the pump operation mode and value setting

The table below explains the setting items of the accumulated time reset and the initial values.

Table 5.176-1 List of pump operation mode and set values

Display	Item	Content	Initial value (Default setting)
SE.24	Pump operation mode	Set the pump operation mode.	PRS
SE.25	Circulating fluid discharge pressure	Set the circulating fluid discharge pressure for the pressure controlled mode.	0.50
SE.26	Pump operation frequency	Set the pump operation frequency for the frequency set mode.	----

Refer to each paragraph for the detail of pump operation mode and value setting.

Tips

When AL.25(circulating fluid discharge pressure sensor failure) occurs in a pressure control mode, a pump operation mode shifts to a frequency setting mode automatically.

1. Press and hold the [MENU] key for approx. 2 sec.

Repeat pressing the key until the setting screen for key-lock [SE.O I] appears on the digital display.

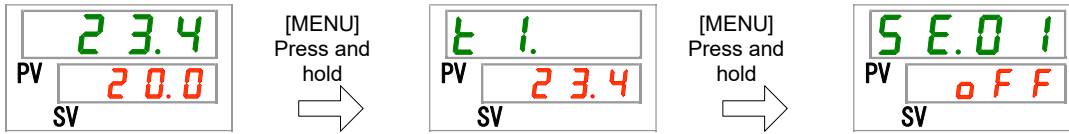

Pump operation mode

2. Press the [SEL] key 23 times.

The set screen of pump operation mode is displayed on the digital display.

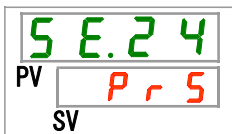

3. Select the pump operation mode from the table below with [▲] key or [▼] key, and confirm by pressing "SEL".

Table 5.17-2 List of set value

Set value	Explanation	Initial value (Default setting)
PrS	Pressure controlled mode	0
FrEE	Frequency set mode	

Circulating fluid discharge pressure

4. Press the [SEL] key once.

The set screen of circulating fluid discharge pressure is displayed on the digital display.



5. Select the circulating fluid discharge pressure from the table below with [▲] key or [▼] key, and confirm by pressing “SEL”.

Table 5.17-3 List of set value

Set value	Explanation	Initial value (Default setting)
----	Setting/checking are not available when the frequency set mode is selected.	
MPa 0.10 to 0.50	Set the circulating fluid discharge pressure. Pressure unit is MPa: Setting unit is 0.01MPa	0.50
PSI 14 to 72	Pressure unit is PSI: Setting unit is 1PSI	72

Pump operation frequency

6. Press the [SEL] key once.

The set screen of pump operation frequency is displayed on the digital display.



7. Select the pump operation frequency from the table below with [▲] key or [▼] key, and confirm by pressing “SEL”.

Table 5.17-4 List of set value

Set value	Explanation	Initial value (Default setting)
----	Setting/checking are not available when the pressure controlled mode is selected..	
40.0 to 60.0	Set the pump operation frequency. Increment: 0.1Hz	40.0

8. Press the [MENU] key once.

Return to the main screen (screen displaying the circulating fluid temperature).



5.18 Warming up function

5.18.1 Warming up function

CAUTION



The power supply should be ON for this function. Otherwise this function cannot start.

During winter or night, this function operates pump automatically to heat the circulating fluid by the pump's heat radiation to keep the circulating fluid temperature around the warming up temperature setting while the product's operation is stopping. If it is necessary to shorten the circulating fluid temperature rising time when starting the operation, set this function in advance.

- The pump operates until the circulating fluid temperature becomes +2°C of the warming up temperature setting.
- When the circulating fluid temperature becomes +2°C of the warming up temperature setting, the pump stops automatically.
- When the circulating fluid temperature becomes -2°C of the warming up temperature setting, the pump operates automatically again.

If the warming up function is set, [RUN] lamp repeats to be lit on for 0.5 sec and off for 3sec. during standing by (When the pump does not operate). The [RUN] lamp blinks every 0.3sec. during the automatic operation of the pump. The default setting of this function is "OFF".

While the warming up function is "ON", the warming up function will be prioritized higher than the anti-freezing function (refer to "5.18 Warming up function") and anti-freezing function does not start.

CAUTION



- This function can be used only while the power supply is ON and the operation is stopping.
- Fully open the valve or manual bypass valve arranged by the customer so that the circulating fluid can circulate when the pump starts automatic operation.
- In extremely cold weather conditions, the heat generated by the pump may not be enough to raise the circulating fluid temperature.
- During the automatic operation, the pump does not stop even if you press "RUN/STOP" key. To stop the pump, shut off the power or make this function "OFF".
- This function cannot prevent the freezing of the auto-fluid fill circuit. Make prevention against the freezing for this by customer.

5.18.2 Warming up function setting and checking

The table below explains the setting items of the warming up function and the initial values.

Table 5.18-1 List of set warming up function

Display	Item	Content	Initial value (Default setting)
SE.27	Warming function up	Sets warming up function	OFF

1. Press and hold the [MENU] key for approx. 2 sec.

Repeat pressing the key until the setting screen for key-lock [SE.01] appears on the digital display.

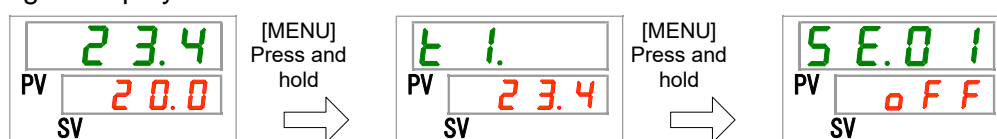

Warming up setting and checking

2. Press the [SEL] key 26 times.

The set screen of warming up is displayed on the digital display.

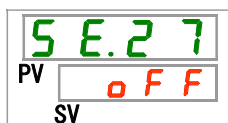

3. Select warming up function from the table below with [▲] key or [▼] key, and confirm by pressing "SEL".

Table 5.18-2 List of set value

Set value	Explanation	Initial value (Default setting)
OFF	Warming up function OFF	0
ON	Warming up function ON	

Warming up temperature setting Setting and checking







4. Press the [SEL] key once.

The set screen of warming up temperature setting is displayed on the digital display.



5. Select the warming up temperature setting from the table below with [▲] key or [▼] key, and confirm by pressing “SEL”.

Table 5.18-3 List of set value

Set value	Explanation	Initial value (Default setting)
----	Setting/checking are not available if the setting of the warming up function is OFF.	
Centigrade  to  Fahrenheit  to 	Sets the warming up set temperature setting. Temperature unit is Centigrade : Setting unit is 0.1°C Temperature unit is Fahrenheit : Setting unit is 0.1°F	 

6. Press the [MENU] key once.

Return to the main screen (screen displaying the circulating fluid temperature).

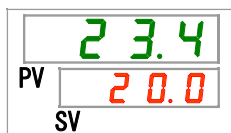

5.19 Alarm buzzer sound setting

5.19.1 Alarm buzzer sound setting

This sets whether a warning sound is made or not when alarm signal is output.

The default setting is buzzer sound ON.

5.19.2 Alarm buzzer sound setting and checking

The table below explains the setting items of the alarm buzzer sound and the initial values.

Table 5.19-1 List of set alarm buzzer sound

Display	Item	Contents	Initial value (Default setting)
	Alarm buzzer sound	Sets alarm buzzer sound.	ON

1. Press and hold the [MENU] key for approx. 2 sec.

Repeat pressing the key until the setting screen for alarm buzzer sound [] appears on the digital display.

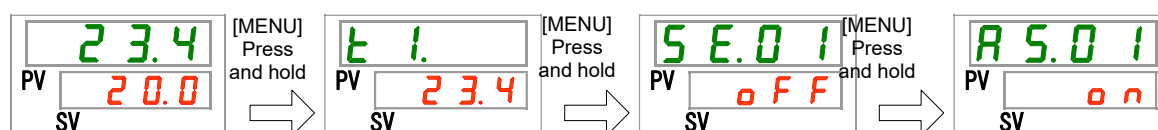

Alarm buzzer sound Setting and checking

2. Select alarm buzzer sound from the table below with [▲] key or [▼] key, and confirm by pressing "SEL".

Table 5.19-2 List of set value

Set value	Explanation	Initial value (Default setting)
	No alarm buzzer sound	
	Alarm buzzer sound	O

3. Press the [MENU] key once.

Return to the main screen (screen displaying the circulating fluid temperature).

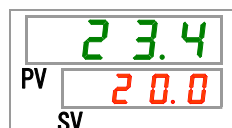

5.20 Alarm customizing function

5.20.1 Alarm customizing function

The operation and the threshold when alarm signal is output can be customized. Customers should set them depending on the applications.

In the table 5.20-1, the contents of the alarm customizing are described.

① Alarm operations (In the table 5.20-1, 2, 3, 4 Alarm initial setting and customizing)

A.STP	: Stops the pump, compressor and fan with the alarm	About the mark of each alarm operation
A.RUN	: Continues running the pump, compressor and fan with the alarm	
P.RUN	: Stops the compressor and fan, and continues running the pump with the alarm *1	
OFF	: Does not generate the alarm.	

○	: Initial setting
●	: Possible to select
-	: Impossible to select

*1: The alarm operations of all the object alarms of the P.RUN cannot be customized individually but collectively.

② Alarm thresholds and others (In the table 5.20-1, 2, 3, 4 Alarm setting and customizing)

The alarm thresholds and other values can be changed from the initial values to new values within the settable range. The parts of - mark cannot be changed.

Table 5.20-1 Alarm setting and customizing (1/4)

Code	Alarm name	① Alarm operations					② Alarm threshold and others*1		
		Display	A.STP	A.RUN	P.RUN	OFF	Display	Default setting	Settable range
AL01	Low level in tank	A5.02	●	○	-	-	-	-	-
AL02	High circulating fluid discharge temp	-	○	-	-	-	-	-	-
AL03	Circulating fluid discharge temp. rise	A5.03	●	○	-	●	Temperature		
							A5.04	45.0°C (113.0°F) (----)*2	5.0 to 55.0°C (41.0 to 131.0°F)
							Monitoring method		
							A5.21	0	0 to 3
							Monitoring start timer		
A5.22	---- (0)*3	0 to 600 minutes							
Range over detection timer									
A5.23	5	5 to 999 seconds							

*1: Values in ° F are displayed when SE12 is F.

*2: The default setting when AS03 is OFF.

*3: The default setting when AS21 is 2 or 3.

Table 5.20-2 Alarm setting and customizing (2/4)

Code	Alarm name	①Alarm operations					②Alarm threshold and others*4			
		Display	A.STP	A.RUN	P.RUN	OFF	Display	Default setting	Settable range	
AL04	Circulating fluid discharge temp. drop	R 5.05	●	○	-	●	R 5.06	Set temperature		
								1.0°C (33.8°F) (----)*5	1.0 to 39.0°C (33.8 to 102.2 ° F)	
								Monitoring method		
								0	0 to 3	
AL04	Circulating fluid discharge temp. drop	R 5.05	●	○	-	●	R 5.21	Monitoring start timer		
								----	(0)*6	0 to 600 minutes
								Range over detection timer		
AL04	Circulating fluid discharge temp. drop	R 5.05	●	○	-	●	R 5.23	5	5 to 999 seconds	
AL05	High circulating return temp.	-	○	-	-	-	-	-		
AL06	High circulating fluid discharge pressure	-	○	-	-	-	-	- *9		
AL07	Abnormal pump operation	-	○	-	-	-	-	- *9		
AL08	Circulating fluid discharge pressure rise	R 5.07	●	○	-	●	R 5.08	Set pressure		
								0.55MPa (80PSI) (----)*7,9	0.05 to 0.60MPa (7 to 87PSI)	
AL09	Circulating fluid discharge pressure drop	R 5.09	●	○	-	●	R 5.10	Set pressure		
								0.05MPa (7PSI) (----)*8,9	0.05 to 0.60MPa (7 to 87PSI)	
AL10	High compressor suction temp.	R 5.24	●	-	○	-	-	-		
AL11	Low compressor suction temp.	R 5.24	●	-	○	-	-	-		
AL12	Low super heat temperature	R 5.24	●	-	○	-	-	-		
AL13	High compressor discharge pressure	R 5.24	●	-	○	-	-	-		
AL15	Refrigerant circuit pressure (high pressure side) drop	R 5.24	●	-	○	-	-	-		
AL16	Refrigerant circuit pressure (low pressure side) rise	R 5.24	●	-	○	-	-	-		

*4: Values in ° F are displayed when SE12 is F, and PSI are displayed when SE13 is PSI.

*5: The default setting when AS05 is OFF.

*6: The default setting when AS21 is 2 or 3.

*7: The default setting when AS07 is OFF.

*8: The default setting when AS09 is OFF.

*9: AL06, AL07, AL08, AL09 are disabled when AS25 is set to A.RUN. (AL06, AL07, AL08, and AL09 will not be generated)

Table 5.20-3 Alarm setting and customizing (3/4)

Code	Alarm name	①Alarm operations					②Alarm threshold and others		
		Display	A.STP	A.RUN	P.RUN	OFF	Display	Default setting	Settable range
AL17	Refrigerant circuit pressure (low pressure side) drop	A 5.24	●	-	○	-	-	-	-
AL18	Compressor running failure	A 5.24	●	-	○	-	-	-	-
AL19	Communication error	A 5.11	●	●	-	○	A 5.12	Monitoring time	
								---- (30)*10	30 to 600 seconds
AL20	Memory error	-	○	-	-	-	-	-	-
AL21	DC line fuse cut	A 5.15	○	●	-	-	-	-	-
AL22	Circulating fluid discharge temp. sensor failure	-	○	-	-	-	-	-	-
AL23	Circulating fluid return temp. sensor failure	-	○	-	-	-	-	-	-
AL24	Compressor suction temp. sensor failure	A 5.24	●	-	○	-	-	-	-
AL25 *9	Circulating fluid discharge pressure sensor failure	A 5.25	○	●	-	-	-	-	Pump operation mode shifts to a frequency setting mode automatically.
AL26	Compressor fluid discharge pressure sensor failure	A 5.24	●	-	○	-	-	-	-
AL27	Compressor suction pressure sensor failure	A 5.24	●	-	○	-	-	-	-
AL28	Pump maintenance	A 5.26	-	●	-	○	-	-	-
AL29	Fan maintenance*11	A 5.27	-	●	-	○	-	-	-
AL30	Compressor maintenance	A 5.28	-	●	-	○	-	-	-
AL31	Contact input 1 signal detection	A 5.13	○	●	-	●	-	-	-
AL32	Contact input 2 signal detection	A 5.14	○	●	-	●	-	-	-

*9: AL06, AL07, AL08, AL09 are disabled when AS25 is set to A.RUN. (AL06, AL07, AL08, and AL09 will not be generated)

*10: The default setting when the setting of the alarm operation for AS11 is A.STP or A.RUN.

*11: This alarm does not occur on the product of water cooled type.

Table 5.20-4 Alarm setting and customizing (4/4)

Code	Alarm name	①Alarm operations					②Alarm threshold and others		
		Display	A.STP	A.RUN	P.RUN	OFF	Display	Default setting	Settable range
AL37	Compressor discharge temp. sensor failure	A 5.2 4	●	-	○	-	-		-
AL38	Compressor discharge temp. rise	A 5.2 4	●	-	○	-	-		-
AL39	Internal unit fan stoppage	-	-	○	-	-	-		-
AL40 *12	Dust-proof filter maintenance	A 5.2 9	-	●	-	○	A 5.3 1	500h	1 to 9999h
AL41	Power stoppage	A 5.3 0	○	-	-	●	-		-
AL42	Compressor waiting	-	-	○	-	-	-		-
AL43 *12	Fan breaker trip	A 5.2 4	●	-	○	-	-		-
AL44 *12	Fan inverter error	A 5.2 4	●	-	○	-	-		-
AL45 *13	Compressor breaker trip	A 5.2 4	●	-	○	-	-		-
AL46	Compressor inverter error	A 5.2 4	●	-	○	-	-		-
AL47 *13	Pump breaker trip	-	○	-	-	-	-		-
AL48	Pump inverter error	-	○	-	-	-	-		-
AL49 *14	Air exhaust fan stoppage	-	-	○	-	-	-		-

*12: This alarm does not occur on the product of water cooled type.

*13: This alarm does not occur on the product of power specification of '-20'. (Except option S.)

*14: This alarm does not occur on the product of air cooled type.

CAUTION



Changing the alarm operation to A.RUN or OFF from A.STP generates alarms without stopping the product. Be sure to remove the cause of the alarm immediately after the alarm occurred. Otherwise it may cause a malfunction of the product.

5.20.2 Alarm customize function setting and checking

The table below explains the setting items of the alarm customize function and the initial values.

Table 5.20-5 List of set alarm customizing function(1/2)

Display	Content	Object alarm		Change content	Default setting*1
		Code	Alarm name		
A 5.02	Changing of low tank level	AL01	Low level in tank	Alarm operation	A.RUN
A 5.03	Changing of circulating fluid discharge temperature rise	AL03	High circulating fluid discharge temp	Alarm operation	A.RUN
A 5.04	Detection temperature for circulating fluid discharge temperature rise			Alarm threshold	45.0°C (113.0°F) (----
A 5.05	Changing of circulating fluid discharge temperature drop	AL04	Circulating fluid discharge temp. drop	Alarm operation	A.RUN
A 5.06	Detection temperature for circulating fluid discharge temperature drop			Alarm threshold	1.0°C (33.8°F) (----
A 5.07	Changing of circulating fluid discharge pressure rise	AL08	Circulating fluid discharge temp. rise	Alarm operation	A.RUN
A 5.08	Detection pressure for circulating fluid pressure rise			Alarm threshold	0.55MPa (80PSI)
A 5.09	Changing of circulating fluid discharge pressure drop	AL09	Circulating fluid discharge pressure drop	Alarm operation	A.RUN
A 5.10	Detection pressure for circulating fluid discharge pressure drop			Alarm threshold	0.05MPa (7PSI) (----
A 5.11	Changing of communication error	AL19	Communication error	Alarm operation	OFF
A 5.12	Monitoring time of communication error			Alarm threshold	---- (30)
A 5.13	Changing of contact input 1 signal detection	AL31	Contact input 1 signal detection	Alarm operation	A.STP
A 5.14	Changing of contact input 2 signal detection	AL32	Contact input 2 signal detection	Alarm threshold	A.STP
A 5.15	Changing of DC line fuse cut	AL21	DC line fuse cut	Alarm operation	A.STP
A 5.21	Temperature alarm monitoring method	AL03	Circulating fluid discharge temp. rise	Selection of monitoring method	0
		AL04	Circulating fluid discharge temp. drop		

*1: Regarding the detail of the default setting, refer to "Table 5.20-1 Alarm setting and customizing (1/4) to (4/4)".

Table 5.20-6 List of set alarm customizing function(2/3)

Display	Content	Object alarm		Change content	Default setting
		Code	Alarm name		
		AL04	Circulating fluid discharge temp. drop		
A 5.2 3	Range over detection timer	AL03	Circulating fluid discharge temp. rise	Alarm does not occur during the set period of time after the temperature goes out of the threshold.	5
		AL04	Circulating fluid discharge temp. drop		
A 5.2 4	Compressor stop alarm	AL10	High compressor suction temp.	Alarm operation	P.RUN
		AL11	Low compressor suction temp.		
		AL12	Low super heat temperature		
		AL13	High compressor discharge pressure		
		AL15	Refrigerant circuit pressure (high pressure side) drop		
		AL16	Refrigerant circuit pressure (low pressure side) rise		
		AL17	Refrigerant circuit pressure (low pressure side) drop		
		AL18	Compressor running failure		
		AL24	Compressor suction temp. sensor failure		
		AL26	Compressor fluid discharge pressure sensor failure		
		AL27	Compressor suction pressure sensor failure		
		AL37	Compressor discharge temp. sensor failure		
		AL38	Compressor discharge temp. rise		
		AL43 *2	Fan breaker trip		
AL44 *2	Fan inverter error				
AL45 *3	Compressor breaker trip				
AL46	Compressor inverter error				

*2: This alarm does not occur on the product of power specification '-20'. (Except option S.)

*3: This alarm does not occur on the product of water cooled type.

Table 5.20-7 List of set alarm customizing function(3/3)

Display	Content	Object alarm		Change content	Initial setting
		Code	Alarm name		
A 5.2 5	Changing of circulating fluid discharge pressure sensor failure	AL25	Circulating fluid discharge pressure sensor failure	Alarm operation	A.STP
A 5.2 6	Changing of pump maintenance	AL28	Pump maintenance	Alarm operation	OFF
A 5.2 7	Changing of fan maintenance	AL29 *3	Fan maintenance	Alarm operation	OFF
A 5.2 8	Changing of compressor maintenance	AL30	Compressor maintenance	Alarm operation	OFF
A 5.2 9	Changing of dust-proof filter maintenance	AL40 *3	Dust-proof filter maintenance	Alarm operation	OFF
A 5.3 0	Changing of power stoppage alarm	AL41	Power stoppage	Alarm operation	A.STP
A 5.3 1	Monitoring time for maintenance of dustproof filter	AL40 *3	Dust-proof filter maintenance	Alarm threshold	500h

*3: This alarm does not occur on the product of water cooled type.

1. Press and hold the [MENU] key for approx. 2 sec.

Repeat pressing the key until the setting screen for alarm buzzer sound [A 5.0 1] appears on the digital display.

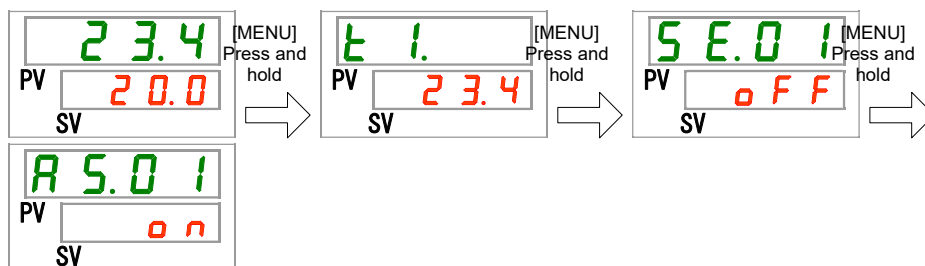

Low tank level Setting and checking

2. Press the [SEL] key once.

The set screen of changing of low tank level is displayed on the digital display.

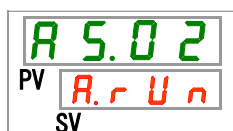

3. Select changing of low tank level from the table below with [▲] key or [▼] key, and confirm by pressing “SEL”.

Table 5.20-8 List of set value

Set value	Explanation	Initial value (Default setting)
A.r U n	Operation continues when this alarm signal is	0

	generated.	
A.S.T.P	Operation is stopped when this alarm signal is generated.	

Changing of circulating fluid discharge temperature rise Setting and checking

4. Press the [SEL] key once.

The set screen of changing of circulating fluid discharge temperature rise is displayed on the digital display.

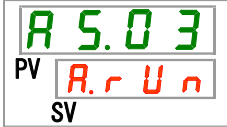

5. Select changing of circulating fluid discharge temperature rise from the table below with [▲] key or [▼] key, and confirm by pressing “SEL”.

Table 5.20-9 List of set value

Set value	Explanation	Initial value (Default setting)
o F F	This alarm signal is not detected.	
R.r U n	Operation continues when this alarm signal is generated.	0
R. S t P	Operation is stopped when this alarm signal is generated.	

Detection temperature for circulating fluid discharge temperature rise Setting and checking

6. Press the [SEL] key once.

The set screen of detection temperature for circulating fluid discharge temperature rise is displayed on the digital display.



7. Select detection temperature for circulating fluid discharge temperature rise from the table below with [▲] key or [▼] key, and confirm by pressing “SEL”.

Table 5.20-10 List of set value

Set value	Explanation	Initial value (Default setting)
- - - -	Setting/checking are not available if the setting of the circulating fluid discharge temperature rise is OFF.	
Centigrade 5.0 to 55.0	Sets detection temp for the circulating fluid discharge temperature rise.	45.0
Fahrenheit 41.0 to 131.0	Temperature unit is Centigrade : Setting unit is 0.1°C Temperature unit is Fahrenheit : Setting unit is 0.1°F	113.0

Changing of circulating fluid discharge temperature drop Setting and checking

8. Press the [SEL] key once.

The set screen of changing of circulating fluid discharge temperature drop is displayed on the digital display.

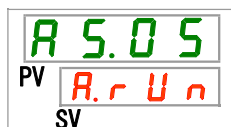

9. Select changing of circulating fluid discharge temperature drop from the table below with [▲] key or [▼] key, and confirm by pressing "SEL".

Table 5.20-11 List of set value

Set value	Explanation	Initial value (Default setting)
<input type="text" value="o F F"/>	This alarm signal is not detected.	
<input type="text" value="R.r U n"/>	Operation continues when this alarm signal is generated.	0
<input type="text" value="R.5 t P"/>	Operation is stopped when this alarm signal is generated.	

Detection temperature for circulating fluid discharge temperature drop Setting and checking

10. Press the [SEL] key once.

The set screen of detection temperature for circulating fluid discharge temperature drop is displayed on the digital display.

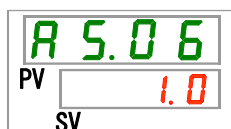

11. Select detection temperature for circulating fluid discharge temperature drop from the table below with [▲] key or [▼] key, and confirm by pressing "SEL".

Table 5.20-12 List of set value

Set value	Explanation	Initial value (Default setting)
<input type="text" value="- - - -"/>	Setting/checking are not available if the setting of the circulating fluid discharge temperature drop is OFF.	
Centigrade <input type="text" value="1.0"/> to <input type="text" value="39.0"/>	Sets detection temp for the circulating fluid discharge temperature drop.	<input type="text" value="1.0"/>
Fahrenheit <input type="text" value="33.8"/> to <input type="text" value="102.2"/>	Temperature unit is Fahrenheit : Setting unit is 0.1°F	<input type="text" value="33.8"/>

Changing of circulating fluid discharge pressure rise Setting and checking

12. Press the [SEL] key once.

The set screen of changing of circulating fluid discharge pressure rise is displayed on the digital display.



13. Select changing of circulating fluid discharge pressure rise from the table below with [▲] key or [▼] key, and confirm by pressing “SEL”.

Table 5.20-13 List of set value

Set value	Explanation	Initial value (Default setting)
o F F	This alarm signal is not detected.	
R.r U n	Operation continues when this alarm signal is generated.	0
R.S t P	Operation is stopped when this alarm signal is generated.	

Detection pressure for circulating fluid discharge pressure rise Setting and checking

14. Press the [SEL] key once.

The set screen of detection temperature for circulating fluid discharge pressure rise is displayed on the digital display.

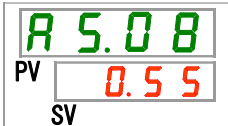

15. Select detection pressure for circulating fluid discharge pressure rise from the table below with [▲] key or [▼] key, and confirm by pressing “SEL”.

Table 5.20-14 List of set value

Set value	Explanation	Initial value (Default setting)
- - - -	Setting/checking are not available if the setting of the circulating fluid discharge pressure rise is OFF.	
MPa 0.0 5 to 0.6 0	Sets detection pressure for the circulating fluid discharge pressure rise. Pressure unit is MPa : Setting unit is 0.01MPa	0.5 5
PSI 7 to 8 7	Pressure unit is PSI : Setting unit is 1PSI	7 9

Changing of circulating fluid discharge pressure drop Setting and checking

16. Press the [SEL] key once.

The set screen of changing of circulating fluid discharge pressure drop is displayed on the digital display.

R 5.09
PV R.5 t P
SV

17. Select changing of circulating fluid discharge pressure drop from the table below with [▲] key or [▼] key, and confirm by pressing "SEL".

Table 5.20-15 List of set value

Set value	Explanation	Initial value (Default setting)
	This alarm signal is not detected.	
	Operation continues when this alarm signal is generated.	
	Operation is stopped when this alarm signal is generated.	0

Detection pressure for circulating fluid discharge pressure drop Setting and checking

18. Press the [SEL] key once.

The set screen of detection temperature for circulating fluid discharge pressure drop is displayed on the digital display.

R 5.10
PV 0.01
SV

19. Select detection temperature for circulating fluid discharge pressure drop from the table below with [▲] key or [▼] key, and confirm by pressing "SEL".

Table 5.20-16 List of set value

Set value	Explanation	Initial value (Default setting)
	Setting/checking are not available if the setting of the circulating fluid discharge pressure drop is OFF.	
MPa to 	Sets detection pressure for the circulating fluid discharge pressure drop.	
PSI to 	Pressure unit is MPa : Setting unit is 0.01MPa Pressure unit is PSI : Setting unit is 1PSI	

Changing of operation when communication error Setting and checking

20. Press the [SEL] key once.

The set screen of changing of operation when communication error is displayed on the digital display.

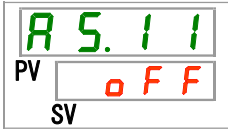

21. Select changing of operation when communication error from the table below with [▲] key or [▼] key, and confirm by pressing “SEL”.

Table 5.20-17 List of set value

Set value	Explanation	Initial value (Default setting)
OFF	This alarm signal is not detected.	0
Run	Operation continues when this alarm signal is generated.	
Set P	Operation is stopped when this alarm signal is generated.	

The monitoring time of communication error Setting and checking

22. Press the [SEL] key once.

The set screen of the monitoring time of communication error is displayed on the digital display.

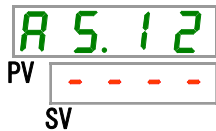

23. Select the monitoring time of communication error from the table below with [▲] key or [▼] key, and confirm by pressing “SEL”.

Table 5.20-18 List of set value

Set value	Explanation	Initial value (Default setting)
----	Setting/checking are not available if the setting of the communication error is OFF.	
30 to 600	Sets communication error. Set unit is 1 sec. unit.	30

Changing of Contact input signal 1 detection Setting and checking

24. Press the [SEL] key once.

The set screen of the changing of contact input signal 1 detection is displayed on the digital display.



- 25.** Select the changing of contact input signal 1 detection from the table below with [▲] key or [▼] key, and confirm by pressing “SEL”.

Table 5.20-19 List of set value

Set value	Explanation	Initial value (Default setting)
OFF	This alarm signal is not detected.	
R. r U n	Operation continues when this alarm signal is generated.	
R. S t P	Operation is stopped when this alarm signal is generated.	0

Changing of Contact input signal 2 detection Setting and checking

- 26.** Press the [SEL] key once.

The set screen of the changing of contact input signal 2 detection is displayed on the digital display.

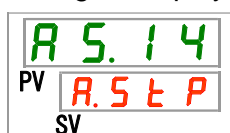

- 27.** Select the changing of contact input signal 2 detection from the table below with [▲] key or [▼] key, and confirm by pressing “SEL”.

Table 5.20-20 List of set value

Set value	Explanation	Initial value (Default setting)
OFF	This alarm signal is not detected.	
R. r U n	Operation continues when this alarm signal is generated.	
R. S t P	Operation is stopped when this alarm signal is generated.	0

Changing of DC line fuse cut Setting and checking

- 28.** Press the [SEL] key once.

The set screen of the changing of DC line fuse cut is displayed on the digital display.

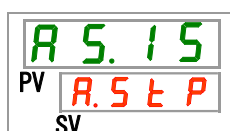

29.Select the changing of DC line fuse cut from the table below with [▲] key or [▼] key, and confirm by pressing “SEL”.

Table 5.20-21 List of set value

Set value	Explanation	Initial value (Default setting)
R. r U n	Operation continues when this alarm signal is generated.	
R. S t P	Operation is stopped when this alarm signal is generated.	0

How to monitor the temperature alarm Setting and Checking

30.Press the [SEL] key once.

Setting screen of the temperature alarm monitoring method is displayed on the digital display.

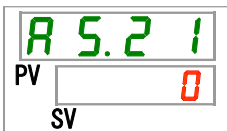

31.Select temperature alarm monitoring method from the table below with [▲] key or [▼] key, and confirm by pressing “SEL”.

Table 5.20-22 List of set value

Set value	Item	Explanation	Initial value (Default setting)
0	Continuous monitoring	Alarm monitoring starts at the same time as operation starts.	0
1	Automatic monitoring	When the circulating fluid temperature is outside of the alarm threshold range at the time of operation start, the alarm will not be generated until the temperature comes inside the alarm threshold range.	
2	Monitoring timer start	Alarm will not be generated until it reaches the time set for the AS.22 "Monitoring start timer" after the operation starts. Alarm monitoring starts when it reaches the set time.	
3	Automatic monitoring + Monitoring timer start	Alarm will not be generated until it reaches the time set for the AS.22 "Monitoring start timer" after the operation starts. Alarm monitoring starts when it reaches the set time. When the circulating fluid temperature enters the alarm threshold range before it reaches the set time, the alarm monitoring will be started at that time.	

* Settings of this function and example of alarm generating timing for 5.15.3 "Setting of temperature alarm monitoring method and generation timing".

Monitoring start timer Setting and Checking

32. Press the [SEL] key once.

Setting screen of the monitoring start timer is displayed on the digital display.

**33.** Select monitoring start timer from the table below with [▲] key or [▼] key, and confirm by pressing "SEL".

Table 5.20-23 List of set value

Set value	Explanation	Initial value (Default setting)
---	Setting and checking are impossible when "0: Continuous monitoring" or "1: Automatic monitoring" is selected for the setting of AS21 "Temperature alarm monitoring method".	0
0 to 600	Sets the time when alarm monitoring starts Setting unit is 1 minute.	

* Settings of this function and example of alarm generating timing for 5.15.3 "Setting of temperature alarm monitoring method and generation timing".

Range over detection timer Setting and Checking

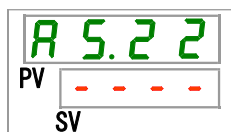
34. Press the [SEL] key once.

Setting screen of the range over detection timer is displayed on the digital display.

**35.** Select the time of the range over detection timer from the table below with [▲] key or [▼] key, and confirm by pressing "SEL".

Table 5.20-24 List of set value

Set value	Explanation	Initial value (Default setting)
5 to 999	Sets time from detecting the alarm to generation of the alarm. Setting unit is 1 second.	5

* Settings of this function and example of alarm generating timing for 5.15.3 "Setting of temperature alarm monitoring method and generation timing".

5.20.3 Setting of temperature alarm monitoring method and alarm generation timing

Examples of temperature alarm monitoring method setting and alarm generation timing are shown below.

■ When "Automatic monitoring" is selected

- [1] Circulating fluid temperature when starting operation: Approximately 20 °C
- [2] Circulating fluid set temperature: 15 °C
- [3] "AS.21: Temperature alarm monitoring method": Select "Automatic monitoring".
("----" (invalid setting) will be shown for "AS.22: Monitoring start timer".)
- [4] "AS.04: Detection temp. for the circulating fluid discharge temp. increase": Set to "16 °C".
- [5] "AS.06: Detection temp. for the circulating fluid discharge temp. drop": Set to "14 °C".
- [6] "AS.23: Range over detection timer "Set to "600 sec".

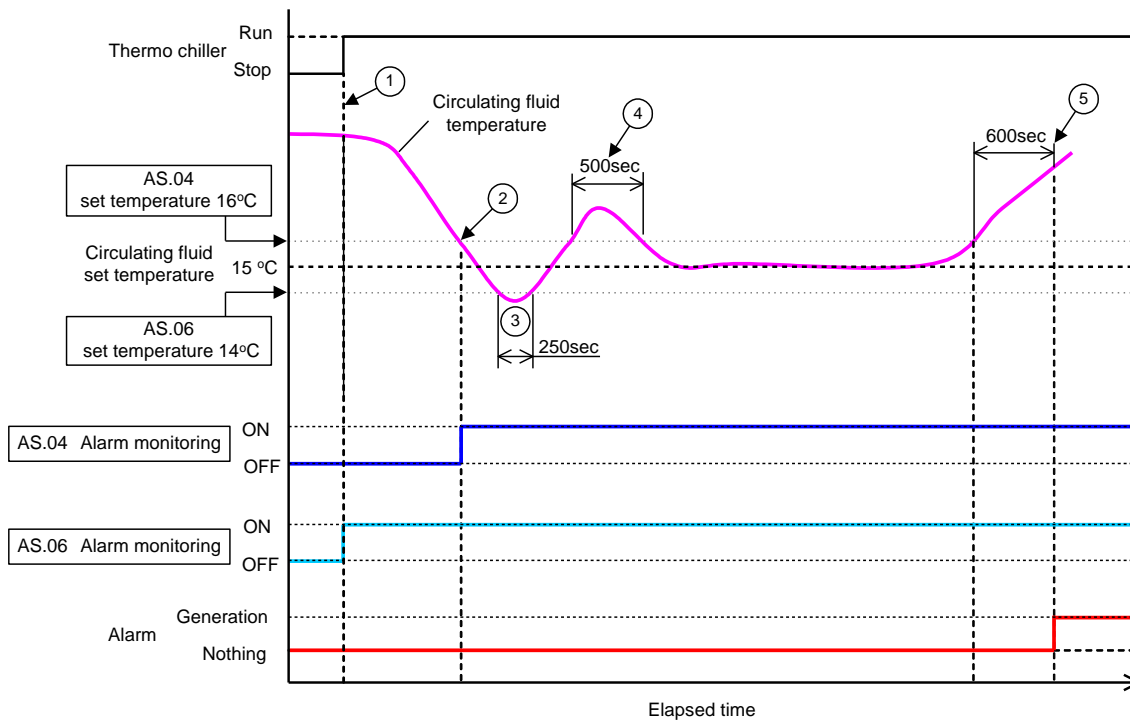

Fig 5-3 Alarm generation timing

■ -Alarm generation timing

- Status (1): Temperature alarm monitoring starts by starting the chiller operation. As the circulating fluid temperature at this time is 20 °C, "AS.06" starts alarm monitoring at the same time as the operation start.
- Status (2): The circulating fluid temperature becomes within the set range of "AS.04", and starts "AS.04" alarm monitoring".
- Status (3): The circulating fluid temperature exceeds the threshold of "AS.06", but the alarm will not be generated as it has returned within the 600 sec range of the "AS.23: Range over detecting timer".
- Status (4): The circulating fluid temperature exceeds the threshold of "AS.04", but the alarm will not be generated as it has returned within the 600 sec range of the "AS.23: Range over detecting timer".
- Status (5): Alarm "AL03: Circulating fluid discharge temp. increase" will be generated after 600 seconds that is set for the "AS.23: Range over detection timer" after the circulating fluid temperature exceeds the threshold of "AS.04".

■ When "Automatic monitoring + Monitoring start timer" is selected

- [1] Circulating fluid temperature when starting operation: Approximately 20 °C
 [2] Circulating fluid set temperature: 15 °C
 [3] "AS.21: Temperature alarm monitoring method": Select "Automatic monitoring + Monitoring start timer".
 [4] "AS.22: Monitoring start timer": Set it to "50 min".
 [5] "AS.04: Detection temp. for the circulating fluid discharge temp. increase": Set to "16 °C".
 [6] "AS.06: Detection temp. for the circulating fluid discharge temp. drop": Set to "14 °C".
 [7] "AS.23: Range over detection timer": Set to "600 sec".

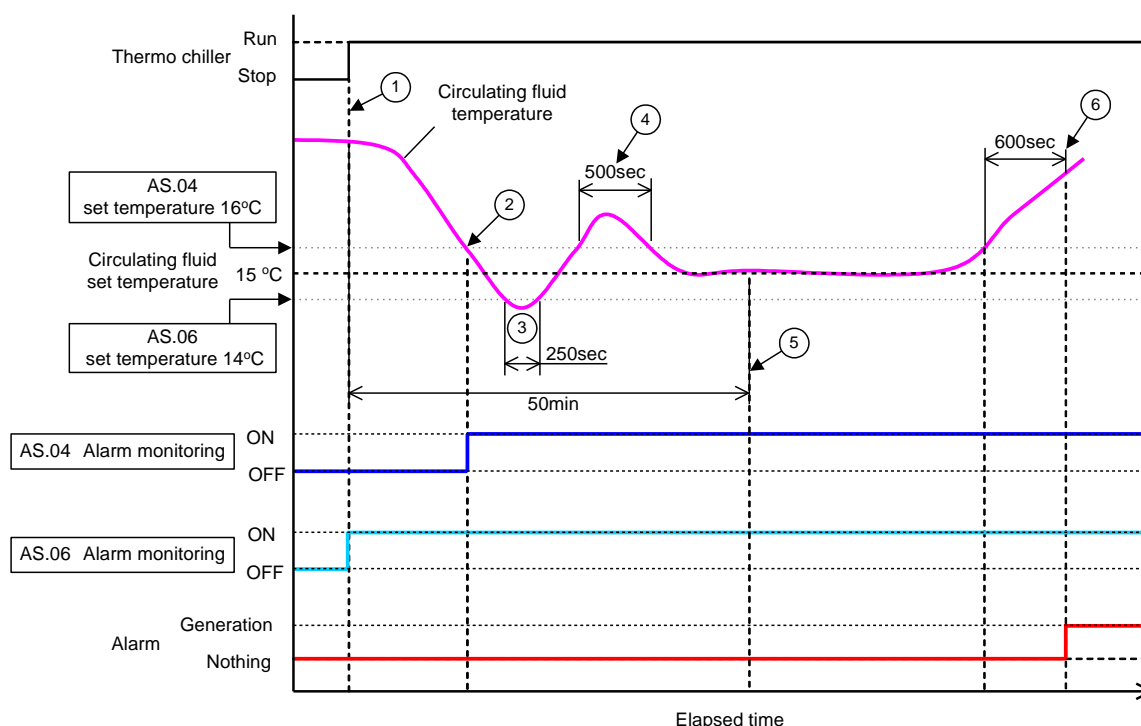

Fig 5-4 Alarm generation timing

■ -Alarm generation timing

- Status (1): Start operation of the chiller. As the circulating fluid temperature is within the set range of "AS.06", "AS.06" alarm monitoring starts.
- Status (2): The circulating fluid temperature becomes within the set range of "AS.04". "AS.04" alarm monitoring starts.
- Status (3): The circulating fluid temperature exceeds the threshold of "AS.06", but the alarm will not be generated as it has returned within the 600 sec range of the "AS.23: Range over detecting timer".
- Status (4): The circulating fluid temperature exceeds the threshold of "AS.04", but the alarm will not be generated as it has returned within the 600 sec range of the "AS.23: Range over detecting timer".
- Status (5): 50 minutes passes after starting operation. Alarm monitoring has started. It shows that the "50 min" setting does not influence the alarm monitoring under these conditions.
- Status (6): Alarm will be generated after 600 seconds that is set for "AS.23: Range over detection timer" after the circulating fluid temperature exceeds the threshold of "AS.04".

Changing of compressor stop alarm Setting and checking

36. Press the [SEL] key once.

Setting screen of the compressor stop alarm is displayed on the digital display.

37. Select the alarm operation for P.RUN from the table 5.20- Object alarm of P.RUN with [▲] key or [▼] key, and confirm by pressing "SEL". The alarm operations of all the object alarms in the table 5.20- will be customized collectively.

Table 5.20-25 Object alarm of P.RUN

Code	Alarm name
AL10	High compressor suction temp.
AL11	Low compressor suction temp.
AL12	Low super heat temperature
AL13	High compressor discharge pressure
AL15	Refrigerant circuit pressure (high pressure side) drop
AL16	Refrigerant circuit pressure (low pressure side) rise
AL17	Refrigerant circuit pressure (low pressure side) drop
AL18	Compressor running failure
AL24	Compressor suction temp. sensor failure
AL26	Compressor fluid discharge pressure sensor failure
AL27	Compressor suction pressure sensor failure
AL37	Compressor discharge temp. sensor failure
AL38	Compressor discharge temp. rise
AL43 *2	Fan inverter breaker trip
AL44 *2	Fan inverter error
AL45 *1	Compressor breaker trip
AL46	Compressor inverter error

*1: Power supply "-20" specification model does not generate this alarm. (Except option S.)

*2: Water-cooled type model does not generate this alarm.

Table 5.20-26 List of set value

Set value	Explanation	Initial value (Default setting)
P.r U n	Compressor and fan are stopped and pump continues running when this alarm signal is generated.	0
A.S t P	Operation is stopped when this alarm signal is generated.	

Changing circulating fluid discharge pressure sensor failure Setting and checking

38. Press the [SEL] key once.

The set screen of the circulating fluid pressure sensor failure is displayed on the digital display.

39. Select the changing of circulating fluid pressure sensor failure from the table below with [▲] key or [▼] key, and confirm by pressing “SEL”.

Table 5.20-27 List of set value

Set value	Explanation	Initial value (Default setting)
A.R.U.N	Operation continues when this alarm signal is generated.	
A.S.T.P	Operation is stopped when this alarm signal is generated.	0

⚠ CAUTION



AL06, AL07, AL08, and AL09 will be disabled when A.RUN is selected. (AL06, AL07, AL08, and AL09 will not be generated). If operation continues with this condition, pump failure cannot be detected. A.STP is recommended.

Changing of pump maintenance Setting and checking

40. Press the [SEL] key once.

The set screen of the changing of pump maintenance is displayed on the digital display.

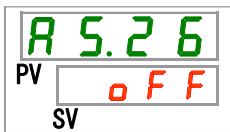

41. Select the changing of pump maintenance from the table below with [▲] key or [▼] key, and confirm by pressing “SEL”.

Table 5.20-28 List of set value

Set value	Explanation	Initial value (Default setting)
o F F	This alarm signal is not detected.	0
A.R.U.N	Operation continues when this alarm signal is generated.	

Changing of Changing of fan maintenance Setting and checking

42. Press the [SEL] key once.

The set screen of the changing of fan maintenance is displayed on the digital display.

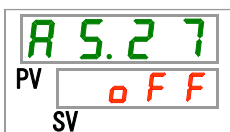

- 43.** Select the changing of fan maintenance from the table below with [▲] key or [▼] key, and confirm by pressing “SEL”.

Table 5.20-29 List of set value

Set value	Explanation	Initial value (Default setting)
<input type="checkbox"/> OFF	This alarm signal is not detected.	0
<input type="checkbox"/> RUN	Operation continues when this alarm signal is generated.	

Changing of compressor maintenance Setting and checking

- 44.** Press the [SEL] key once.

The set screen of the changing of compressor maintenance is displayed on the digital display.

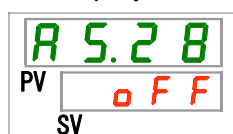

- 45.** Select the changing of compressor maintenance from the table below with [▲] key or [▼] key, and confirm by pressing “SEL”.

Table 5.20-30 List of set value

Set value	Explanation	Initial value (Default setting)
<input type="checkbox"/> OFF	This alarm signal is not detected.	0
<input type="checkbox"/> RUN	Operation continues when this alarm signal is generated.	

Changing of dust-proof filter maintenance Setting and checking

- 46.** Press the [SEL] key once.

The set screen of the changing of dust-proof filter maintenance is displayed on the digital display.

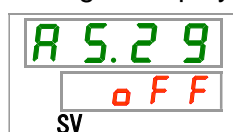

- 47.** Select the changing of dust-proof filter maintenance from the table below with [▲] key or [▼] key, and confirm by pressing “SEL”.

Table 5.20-31 List of set value

Set value	Explanation	Initial value (Default setting)
<input type="checkbox"/> OFF	This alarm signal is not detected.	0
<input type="checkbox"/> RUN	Operation continues when this alarm signal is generated.	

Changing of dust-proof filter maintenance Setting and checking

48. Press the [SEL] key once.

The set screen of the changing of dust-proof filter maintenance is displayed on the digital display.

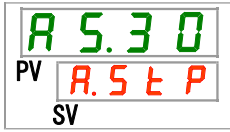

49. Select the changing of dust-proof filter maintenance from the table below with [▲] key or [▼] key, and confirm by pressing “SEL”.

Table 5.20-32 List of set value

Set value	Explanation	Initial value (Default setting)
o F F	This alarm signal is not detected.	0
R.5 t P	Operation continues when this alarm signal is generated.	

Setting and checking of the monitoring time for maintenance of dustproof filter

50. Press the [SEL] key once.

Monitoring time of dustproof filter maintenance is displayed on the digital display.

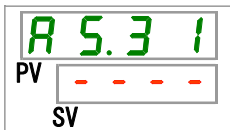

51. Set the monitoring time of the dustproof filter maintenance by [▲] key or [▼] key, and confirm by pressing “SEL”.

Table 5.20-33 List of set value

Set value	Explanation	Initial value (Default setting)
- - - -	In case of AS29(dust-ploof filter maintenance setting and checking) turning off, can not set and check.	
to 9999	Sets time to generate alarm. Setting unit is 1 hour.	500

5.21 Communication function

5.21.1 Communication function

The product can have contact input/output and serial communication. Refer to the Operation Manual for communication for details.

5.21.2 Communication function setting and checking

The table below explains the setting items of the communication function and the initial values.

Table 5.21-1 List of set communication function

Display	Item	Contents	Default setting	
[Co.01]	Communication mode	Sets communication mode.	LOC	
[Co.02]	Serial protocol	Sets serial communication protocol.	MDBS	
[Co.03]	Communication specification	Sets standard of the serial communication.	485	
[Co.04]	RS-485 terminal	Sets of the terminal of RS-485.	OFF	
[Co.05]	Mod bus	Slave address	Sets slave address.	1 (----)*1
[Co.06]		Communication speed	Sets communication speed.	19.2 (----)*1
[Co.07]	Simple communication protocol	Slave address	Sets slave address.	---- (1)*1
[Co.08]		Communication speed	Sets communication speed.	---- (9.6)*1
[Co.09]		BCC	Sets error detection code.	---- (ON)*1
[Co.10]		Data length	Sets data length.	---- (8BIT)*1
[Co.11]		Parity check	Sets parity check.	---- (NON)*1
[Co.12]		Stop bit length	Sets stop bit length	---- (2BIT)*1
[Co.13]		Response delay time	Sets time to delay the response message.	---- (0)*1
[Co.14]	Communication range	Sets communication range.	---- (RW)*1	
[Co.15]	Contact input signal 1	Sets contact input signal 1.	RUN	
[Co.16]	Contact input signal 1 type	Sets input type of contact input signal 1.	ALT	
[Co.17]	Contact input signal 1 Delay timer (time delay) of reading	Sets the delay timer of reading of contact input signal 1.	---- (0)*2	
[Co.18]	Contact input signal 1 OFF detection timer	Sets the contact input signal 1 OFF detection timer	---- (0)*2	
[Co.19]	Contact input signal 2	Sets contact input signal 2.	OFF	
[Co.20]	Contact input signal 2 type	Sets input type of contact input signal 2.	ALT	
[Co.21]	Contact input signal 2 Delay timer (time delay) of reading	Sets the delay timer of reading of contact input signal 2.	---- (0)*3	
[Co.22]	Contact input signal 2 OFF detection timer	Sets the contact input signal 2 OFF detection timer	---- (0)*3	
[Co.23]	Contact output signal 1 function	Sets contact output signal 1.	RUN	
[Co.24]	Contact output signal 1 operation	Sets input type of contact output signal 1.	A	
[Co.25]	Contact output signal 1 selected alarm	Sets alarm which is selected for contact output 1.	---- (AL.01) *4	
[Co.26]	Contact output signal 2 function	Sets output signal function of contact output 2.	RMT	
[Co.27]	Contact output signal 2 operation	Sets output signal operation of contact output 2.	A	
[Co.28]	Contact output signal 2 selected alarm	Sets alarm which is selected for contact output 2.	---- (AL.01) *5	
[Co.29]	Contact output signal 3 function	Sets output signal function of contact output 3.	ALM	
[Co.30]	Contact output signal 3 operation	Sets output signal operation of contact output 3.	B	
[Co.31]	Contact output signal 3 selected alarm	Sets alarm which is selected for contact output 3.	---- (AL.01) *6	

*1: The default setting when CO2 is PRO1 or PRO2.

*2: The default setting when CO15 is SW-A or SW-B.

*3: The default setting when CO19 is SW-A or SW-B.

*4: The default setting when CO23 is A.SEL.

*5: The default setting when CO26 is A.SEL.

*6: The default setting when CO29 is A.SEL.

Communication mode setting and checking

1. Press and hold the [MENU] key for approx. 2 sec.

Repeat pressing the key until the setting screen for communication mode [Co.01] appears on the digital display.

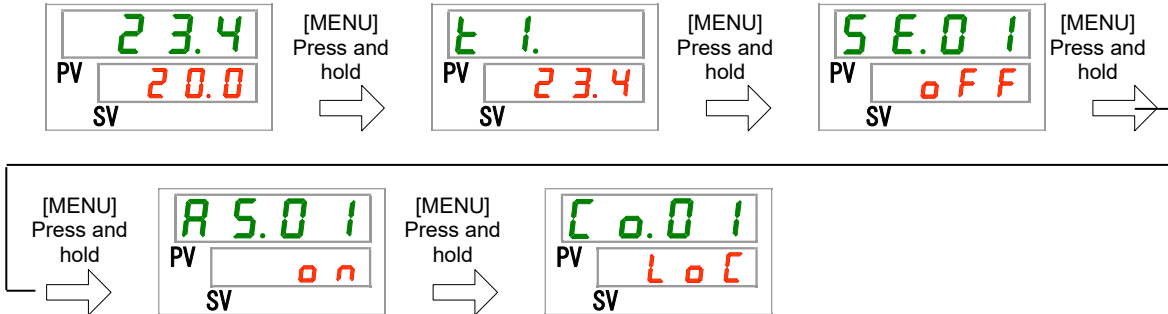

2. Select communication mode from the table below with [▲] key or [▼] key, and confirm by pressing “SEL”.

Table 5.21-2 List of set value

Set value	Explanation	Initial value (Default setting)
LoC	Sets LOCAL mode. (The operation panel operates and sets the thermo-chiller.)	0
dIo	Sets DIO mode.*1 (The operation starts with contact input/output.)	
SEr	Sets SERIAL mode.*2 (Serial communication performs operation/setting.)	

*1: When the setting of the contact input 1 is “External switch signal”, “DIO mode” cannot be set.

*2: If the serial protocol is “Simple communication protocol 2” and the contact input 1 is “external switch signal” or contact input 2 is “remote signal”, “SERIAL mode” cannot be set.

Serial protocol Setting and checking

3. Press the [SEL] key once.

The set screen of serial protocol is displayed on the digital display.

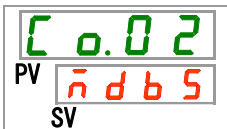

4. Select serial protocol from the table below with [▲] key or [▼] key, and confirm by pressing “SEL”.

Table 5.21-3 List of set value

Set value	Explanation	Initial value (Default setting)
n d b 5	MODBUS protocol	0
P r o 1	Simple communication protocol 1	
P r o 2	Simple communication protocol 2*3	

*3: When the setting of the contact input 2 is “Remote signal”, “Simplified communication protocol 2” cannot be set.

Communication specification Setting and checking

5. Press the [SEL] key once.

The set screen of communication specification is displayed on the digital display.



6. Select communication specification from the table below with [▲] key or [▼] key, and confirm by pressing “SEL”.

Table 5.21-4 List of set value

Set value	Explanation	Initial value (Default setting)
2 3 2 C	RS-232C standard	
4 8 5	RS-485 standard	0

RS-485 terminal Setting and checking

7. Press the [SEL] key once.

The set screen of RS-485 terminal is displayed on the digital display.

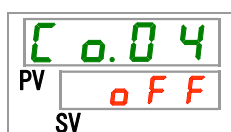

8. Select RS-485 terminal from the table below with [▲] key or [▼] key, and confirm by pressing “SEL”.

Table 5.21-5 List of set value

Set value	Explanation	Initial value (Default setting)
0 F F	Without terminal	0
0 n	With terminal	

Slave addresses(MODBUS) Setting and checking

9. Press the [SEL] key once.

The set screen of slave addresses (MODBUS) is displayed on the digital display.

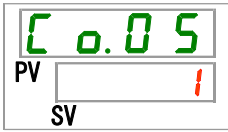

10. Select slave addresses (MODBUS) from the table below with [▲] key or [▼] key, and confirm by pressing “SEL”.

Table 5.21-6 List of set value

Set value	Explanation	Initial value (Default setting)
----	Setting/checking are not available unless the serial protocol setting is MODBUS.	
1 to 99	Sets of slave addresses for MODBUS. Set range is 1 to 99.	1

Communication speed (MODBUS) Setting and checking

11. Press the [SEL] key once.

The set screen of communication speed (MODBUS) is displayed on the digital display.

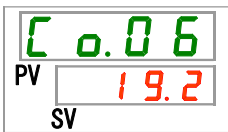

12. Select communication speed (MODBUS) from the table below with [▲] key or [▼] key, and confirm by pressing “SEL”.

Table 5.21-7 List of set value

Set value	Explanation	Initial value (Default setting)
----	Setting/checking are not available unless the serial protocol setting is MODBUS.	
9.6	9600bps	
19.2	19200bps	0

Slave addresses (simple communication protocol) Setting and checking

13. Press the [SEL] key once.

The set screen of slave addresses (simple communication protocol) is displayed on the digital display.



- 14.** Select slave addresses (simple communication protocol) from the table below with [▲] key or [▼] key, and confirm by pressing “SEL”.

Table 5.21-8 List of set value

Set value	Explanation	Initial value (Default setting)
----	Setting/checking are not available unless the serial protocol setting is simple communication protocol.	
1 to 99	Sets of slave addresses for simple communication protocol. Set range is 1 to 99.	1

Communication speed (simple communication protocol) Setting/checking

- 15.** Press the [SEL] key once.

The set screen of communication speed (simple communication protocol) is displayed on the digital display.



- 16.** Select communication speed (serial communication protocol) from the table below with [▲] key or [▼] key, and confirm by pressing “SEL”.

Table 5.21-9 List of set value

Set value	Explanation	Initial value (Default setting)
----	Setting/checking are not available unless the serial protocol setting is simple communication protocol.	
1.2	1200bps	
2.4	2400bps	
4.8	4800bps	
9.6	9600bps	0
19.2	19200bps	

BCC (simple communication protocol) Setting/checking

- 17.** Press the [SEL] key once.

The set screen of BCC (simple communication protocol) is displayed on the digital display.



18.Select BCC (simple communication protocol) from the table below with [▲] key or [▼] key, and confirm by pressing “SEL”.

Table 5.21-10 List of set value

Set value	Explanation	Initial value (Default setting)
----	Setting/checking are not available unless the serial protocol setting is simple communication protocol.	
oFF	Without BCC	
o n	With BCC	0

Data length (simple communication protocol) Setting and checking

19.Press the [SEL] key once.

The set screen of data length (simple communication protocol) is displayed on the digital display.



20.Select data length (simple communication protocol) from the table below with [▲] key or [▼] key, and confirm by pressing “SEL”.

Table 5.21-11 List of set value

Set value	Explanation	Initial value (Default setting)
----	Setting/checking are not available unless the serial protocol setting is simple communication protocol.	
7bit	7 bit	
8bit	8 bit	0

Parity check (simple communication protocol) Setting and checking

21.Press the [SEL] key once.

The set screen of parity check (simple communication protocol) is displayed on the digital display.



- 22.** Select parity check (simple communication protocol) from the table below with [▲] key or [▼] key, and confirm by pressing “SEL”.

Table 5.21-12 List of set value

Set value	Explanation	Initial value (Default setting)
----	Setting/checking are not available unless the serial protocol setting is simple communication protocol.	
n o n	None	0
o d d	Odd number	
E v E n	Even number	

Stop bit (simple communication protocol) Setting and checking

- 23.** Press the [SEL] key once.

The set screen of stop bit (simple communication protocol) is displayed on the digital display.



- 24.** Select stop bit (simple communication protocol) from the table below with [▲] key or [▼] key, and confirm by pressing “SEL”.

Table 5.21-13 List of set value

Set value	Explanation	Initial value (Default setting)
----	Setting/checking are not available unless the serial protocol setting is simple communication protocol.	
1 b i t	1 bit	
2 b i t	2 bit	0

Response delay time (simple communication protocol) Setting and checking

- 25.** Press the [SEL] key once.

The set screen of response delay time (simple communication protocol) is displayed on the digital display.



26.Select response delay time (simple communication protocol) from the table below with [▲] key or [▼] key, and confirm by pressing “SEL”.

Table 5.21-14 List of set value

Set value	Explanation	Initial value (Default setting)
----	Setting/checking are not available unless the serial protocol setting is simple communication protocol.	
0 to 250	Setting of response delay time. Set range is 0 to 250m sec.	0

Communication range (simple communication protocol) Setting and checking

27.Press the [SEL] key once.

The set screen of communication range (simple communication protocol) is displayed on the digital display.

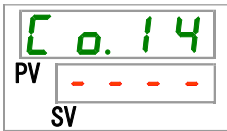

28.Select communication range (simple communication protocol) from the table below with [▲] key or [▼] key, and confirm by pressing “SEL”.

Table 5.21-15 List of set value

Set value	Explanation	Initial value (Default setting)
----	Setting/checking are not available unless the serial protocol setting is simple communication protocol.	
ro	Only reading is available	
rw	Reading and writing are available	0

Contact input signal 1 Setting and checking

29.Press the [SEL] key once.

The set screen of contact input signal 1 is displayed on the digital display.

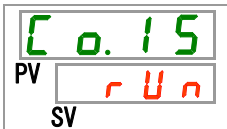

- 30.** Select contact input signal 1 from the table below with [▲] key or [▼] key, and confirm by pressing “SEL”.

Table 5.21-16 List of set value

Set value	Explanation	Initial value (Default setting)
OFF	Without signal input	
run	Start and stop signal input	0
SH_A	External switch signal input(N.O. type) ^{*4,*5}	
SH_b	External switch signal input (N.C. type) ^{*4,*5}	

*4: When the setting of the communication mode is “DIO mode”, “External switch signal” cannot be set.

*5: When the setting of the communication mode is “SEIRAL mode” and the protocol setting is “Simplified communication protocol 2”, “External switch signal” cannot be set.

Contact input signal 1 type Setting and checking

- 31.** Press the [SEL] key once.

The set screen of contact input signal 1 type is displayed on the digital display.



- 32.** Select contact input signal 1 type from the table below with [▲] key or [▼] key, and confirm by pressing “SEL”.

Table 5.21-17 List of set value

Set value	Explanation	Initial value (Default setting)
----	Setting/checking are not available if the setting of contact input signal 1 is OFF.	
ALt	Alternate signal	0
nt	Momentary signal ^{*6}	

*6: Used when the setting of the contact input 1 is “Operation stop signal input”.

Contact input signal 1 delay timer of reading Setting and checking

- 33.** Press the [SEL] key once.

The set screen of the contact input signal 1 delay timer of reading is displayed on the digital display.

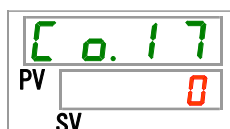

34.Select contact input signal 1 delay timer of reading from the table below with [▲] key or [▼] key, and confirm by pressing “SEL”.

Table 5.21-18 List of set value

Set value	Explanation	Initial value (Default setting)
----	Setting and checking are not available unless contact input signal 1 is external switch signal input (N.O. type or N.C. type).	
0 to 300	Setting of contact input signal 1 delay timer of reading. Set range is 0 to 300 sec.	0

Contact input signal 1 OFF detection timer Setting and checking

35.Press the [SEL] key once.

The set screen of the contact input signal 1 OFF detection timer is displayed on the digital display.



36.Select contact input signal 1 OFF detection timer from the table below with [▲] key or [▼] key, and confirm by pressing “SEL”.

Table 5.21-19 List of set value

Set value	Explanation	Initial value (Default setting)
----	Setting and checking are not available unless contact input signal 1 is external switch signal input (N.O. type or N.C. type).	
0 to 10	Setting of contact input signal 1 OFF detection timer Set range is 0 to 10sec.	0

Contact input signal 2 Setting and checking

37.Press the [SEL] key once.

The set screen of contact input signal 2 is displayed on the digital display.

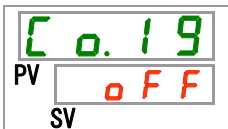

- 38.** Select contact input signal 2 from the table below with [▲] key or [▼] key, and confirm by pressing “SEL”.

Table 5.21-20 List of set value

Set value	Explanation	Initial value (Default setting)
o F F	Without signal input	0
r U n	Run/stop signal input	
S H - A	External switch signal input(N.O. type)	
S H - b	External switch signal input (N.C. type)	
r n t	Remote signal input*7	

*7: When the setting of the serial protocol is “Simplified communication protocol 2”, “Remote signal” cannot be set.

Contact input signal 2 type Setting and checking

- 39.** Press the [SEL] key once.

The set screen of contact input signal 2 type is displayed on the digital display.



- 40.** Select contact input signal 2 type from the table below with [▲] key or [▼] key, and confirm by pressing “SEL”.

Table 5.21-21 List of set value

Set value	Explanation	Initial value (Default setting)
- - - -	Setting/checking are not available if the setting of contact input signal 1 is OFF.	
A L t	Alternate signal	0
r n t	Momentary signal*8	

*8 Can be set when the setting of contact input signal 2 is "Run/Stop signal input" or "Remote signal"

Contact input signal 2 delay timer of reading Setting and checking

- 41.** Press the [SEL] key once.

The set screen of contact input signal 2 delay timer of reading is displayed on the digital display.



42. Select contact input signal 2 delay timer of reading from the table below with [▲] key or [▼] key, and confirm by pressing “SEL”.

Table 5.21-22 List of set value

Set value	Explanation	Initial value (Default setting)
----	Setting and checking are not available unless contact input signal 2 is external switch signal input (N.O. type or N.C. type).	
0 to 300	Setting of contact input signal 2 delay timer of reading. Set range is 0 to 300 sec.	0

Contact input signal 2 OFF detection timer Setting and checking

43. Press the [SEL] key once.

The set screen of contact input signal 2 OFF detection timer is displayed on the digital display.

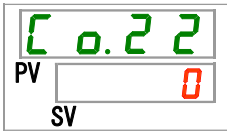

44. Select contact input signal 2 OFF detection timer from the table below with [▲] key or [▼] key, and confirm by pressing “SEL”.

Table 5.21-23 List of set value

Set value	Explanation	Initial value (Default setting)
----	Setting and checking are not available unless contact input signal 2 is external switch signal input (N.O. type or N.C. type).	
0 to 10	Setting of contact input signal 2 OFF detection timer Set range is 0 to 10sec.	0

Contact output signal 1 function Setting and checking

45. Press the [SEL] key once.

The set screen of contact output signal 1 function is displayed on the digital display.

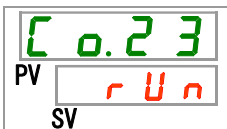

- 46.** Select contact output signal 1 function from the table below with [▲] key or [▼] key, and confirm by pressing “SEL”.

Table 5.21-24 List of set value

Set value	Explanation	Initial value (Default setting)
o F F	Without signal output	
r U n	Operation status signal output	0
r n t	Remote status signal output	
r d y	Ready completion (TEMP READY) signal output	
R S t P	Operation stop alarm signal output	
R r U n	Operation continuation alarm signal output	
A L n	Alarm status signal output	
R S E L	Selected alarm status signal output	
o n t n	Operation start timer setting status signal output	
o F t n	Operation stop timer setting status signal output	
P r S t	Recovery from power failure setting status signal output	
F P	Anti-freezing setting status signal output	
I n P 1	Contact input signal 1 pass through signal output	
I n P 2	Contact input signal 2 pass through signal output	
H R r n	Warming up function setting status output	
R F I L	Signal output during automatic fluid filling	

Contact output signal 1 operation Setting and checking

- 47.** Press the [SEL] key once.

The set screen of contact output signal 1 operation is displayed on the digital display.

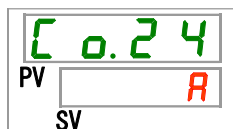

- 48.** Select contact output signal 1 operation from the table below with [▲] key or [▼] key, and confirm by pressing “SEL”.

Table 5.21-25 List of set value

Set value	Explanation	Initial value (Default setting)
A	N.O type	0
b	N.C type	

Contact output signal 1 selected alarm Setting and checking

- 49.** Press the [SEL] key once.

The set screen of contact output signal 1 selected alarm is displayed on the digital display.



50. Select contact output signal 1 selected alarm from the table below with [▲] key or [▼] key, and confirm by pressing “SEL”.

Table 5.21-26 List of set value

Set value	Explanation	Initial value (Default setting)
----	Setting/checking are not available unless the function setting of digital output 1 is selected alarm status signal.	
AL.01 to AL.48	Sets selection alarm. Set range is AL.01 to AL.48.	AL.01

Contact output signal 2 function Setting and checking

51. Press the [SEL] key once.

The set screen of contact output signal 2 functions are displayed on the digital display.

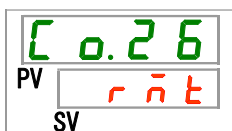

52. Select contact output signal 2 function from the table below with [▲] key or [▼] key, and confirm by pressing “SEL”.

Table 5.21-27 List of set value

Set value	Explanation	Initial value (Default setting)
OFF	Without signal output	
run	Operation status signal output	
rnt	Remote status signal output	0
rdy	Ready completion (TEMP READY) signal output	
AL.SP	Operation stop alarm signal output	
AL.run	Operation continuation alarm signal output	
AL.n	Alarm status signal output	
ALSEL	Selected alarm status signal output	
ontn	Operation start timer setting status signal output	
of.tn	Operation stop timer setting status signal output	
PrSt	Recovery from power failure setting status signal output	
F.P.	Anti-freezing setting status signal output	
INP1	Contact input signal 1 pass through signal output	
INP2	Contact input signal 2 pass through signal output	
WARn	Warming up function setting status output	
R.F.I.L	Signal output during automatic fluid filling	

Contact output signal 2 operation Setting and checking

53. Press the [SEL] key once.

The set screen of contact output signal 2 operation is displayed on the digital display.

**54.** Select contact output signal 2 operation from the table below with [▲] key or [▼] key, and confirm by pressing "SEL".

Table 5.21-28 List of set value

Set value	Explanation	Initial value (Default setting)
A	N.O type	O
b	N.C type	

Digital output signal 2 selected alarm Setting and checking

55. Press the [SEL] key once.

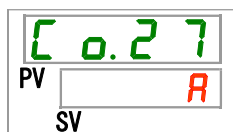
The set screen of contact output signal 2 selected alarm is displayed on the digital display.

**56.** Select contact output signal 2 selected alarm from the table below with [▲] key or [▼] key, and confirm by pressing "SEL".

Table 5.21-29 List of set value

Set value	Explanation	Initial value (Default setting)
----	Setting/checking are not available unless the function setting of digital output 2 is selected alarm status signal.	
AL.01 to AL.48	Sets selected alarm Set range is AL.01 to AL.48.	AL.01

Contact output signal 3 function Setting and checking

57. Press the [SEL] key once.

The set screen of contact output signal 3 function is displayed on the digital display.



58.Select contact output signal 3 function from the table below with [▲] key or [▼] key, and confirm by pressing “SEL”.

Table 5.21-30 List of set value

Set value	Explanation	Initial value (Default setting)
OFF	Without signal output	
run	Operation status signal output	
rn̄t	Remote status signal output	
rdy	Ready completion (TEMP READY) signal output	
ALtP	Operation stop alarm signal output	
ArUn	Operation continuation alarm signal output	
ALn̄	Alarm status signal output	0
ASEL	Selected alarm status signal output	
ontn̄	Operation start timer setting status signal output	
of.tn̄	Operation stop timer setting status signal output	
PrSt	Recovery from power failure setting status signal output	
F.P.	Anti-freezing setting status signal output	
INP1	Contact input signal 1 pass through signal output	
INP2	Contact input signal 2 pass through signal output	
War̄n̄	Warming up function setting status output	
R.FIL	Signal output during automatic fluid filling	

Contact output signal 3 operation Setting and checking

59.Press the [SEL] key once.

The set screen of contact output signal 3 operation is displayed on the digital display.

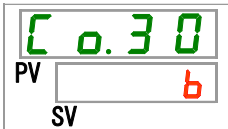

60.Select contact output signal 3 operation from the table below with [▲] key or [▼] key, and confirm by pressing “SEL”.

Table 5.21-31 List of set value

Set value	Explanation	Initial value (Default setting)
A	N.O type	
b	N.C type	0

Contact output signal 3 selected alarm Setting and checking

61.Press the [SEL] key once.

The set screen of contact output signal 3 selected alarm is displayed on the digital display.



- 62.** Select contact output signal 3 selected alarm from the table below with [▲] key or [▼] key, and confirm by pressing “SEL”.

Table 5.21-32 List of set value

Set value	Explanation	Initial value (Default setting)
----	Setting/checking are not available unless the function setting of digital output 3 is selected alarm status signal.	
AL.01 to AL.48	Sets selected alarm Set range is AL.01 to AL.48.	AL.01

- 63.** Press the [MENU] key once.

Return to the main screen (screen displaying the circulating fluid temperature).

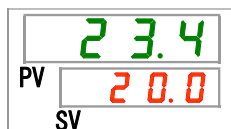

Chapter 6 Option

6.1 Option M [DI water (Pure water) piping]

6.1.1 Option M [DI water (Pure water) piping]

This option is for customers who use DI water (pure water) as circulating fluid.

Circulating materials	fluid	wetted	Stainless (Include heat exchanger brazing), SiC, Carbon, PTFE, PP, PE, POM, FKM, EPDM, PVC (No. copper used)
-----------------------	-------	--------	--

- Serviceable conductivity: 0.22 μ S/cm or more. (Resistivity: 4.5M Ω ·cm or less.)

6.2 Option J [Automatic fluid filling]

6.2.1 Option J [Automatic fluid filling]

This function is available for customers who selected automatic fluid filling.

Refer “3.6 Option J Piping of 【Automatic fluid filling】 ” for the installation of the automatic fluid filling.

Piping to the automatic fluid filling port enables easy supply of the circulating fluid through the level switch in the tank.

Starts supplying the circulating fluid automatically when the circulating fluid amount in the tank is small.

Stops supplying the circulating fluid automatically when the circulating fluid is filled in the tank.

Automatic fluid filling does not start when alarm of table 5-19-1 is generated. Fluid filling stops if the filling is automatic.

Table 6.2-1 Table of alarms automatic fluid filling stops / does not start

Code	Description
AL02	High circulating fluid discharge temp.
AL05	High circulating fluid return temp.
AL06	High circulating fluid discharge pressure
AL07	Abnormal pump operation
AL20	Memory error
AL22	Circulating fluid discharge temp. sensor failure
AL23	Circulating fluid return temp. sensor failure
AL41	Power stoppage
AL47	Pump beaker trip
AL48	Pump inverter error

CAUTION



- This function starts both in stand-by condition (power supply switch is ON) and in operation.
- The freezing of the automatic fluid filling circuit can not be prevented if an anti-freezing function is used. To be arranged by the user.
- Depends on the difference between supplied fluid temperature and set temperature might fluctuate temporarily.

Chapter 7 Alarm indication and trouble shooting

7.1 Alarm Display

When some alarms occur, the product responds with the following conditions.

- The [ALARM] lamp blinks.
- The alarm buzzer sounds.
- The alarm no. is displayed on PV.
- Contact signal of contact input/output communication is output. Refer to the Operation Manual for communication for details.
- Read alarm status with serial communication. Refer to the Operation Manual for communication for details.
- The thermo-chiller has two types of operation depending on the alarm status.

One alarm type will stop operation when an alarm is generated during operation. The other type will not stop operation even when an alarm is generated.

Refer to the "Table 7-1 Alarm code list and Troubleshooting". When the operation is forced to stop, the product cannot restart until the alarm is reset.

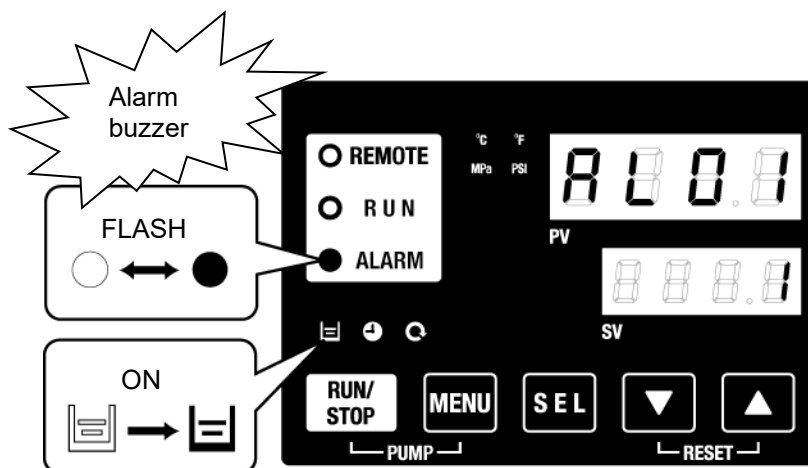

* [] lamp lights only when AL01 Low tank level is generated.

- When multiple alarms are generated, the alarms are displayed one by one by pressing the [SEL] key

Alarm with no.1 on the digital display SV is the latest alarm. The alarm with the highest number is the alarm that was generated first.

[Example of display]

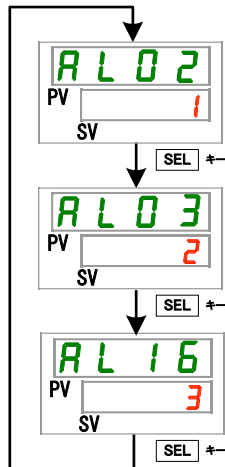

In case that the alarms are generated in the order AL16, AL03, AL02.

The alarm code displayed on the operation panel is AL02. AL03, AL16 are displayed by pressing the [SEL] key.

Digital display SV displays “3” when AL16 is displayed. In this example, AL16’s one is the highest number. This means AL16 is the alarm generated first.

7.2 Alarm buzzer stop

The alarm buzzer sounds to notify when the alarm signal is output. This page explains how to stop the alarm buzzer.

- Ensure that the alarm display screen is displayed. The alarm buzzer can only be stopped on this screen.
- Press [▼] and [▲] keys down simultaneously..
- The alarm buzzer is stopped.

[Tips]

- The alarm buzzer can be set not to make sound. Refer to 5.15". The procedure to stop the alarm buzzer is not necessary when the buzzer is set not to make a sound.
- If this procedure is performed when the cause of the alarm has been eliminated before stopping the alarm buzzer, the alarm will be reset at the same time.

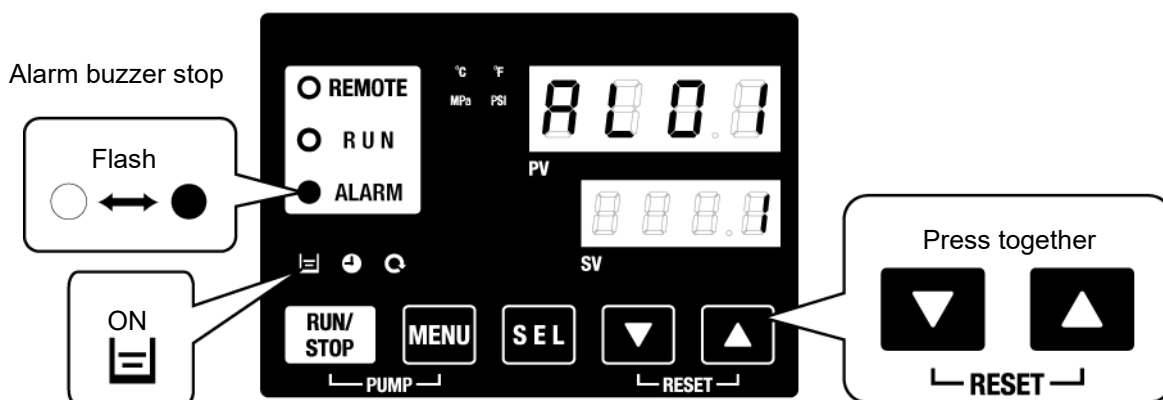

* [ lamp lights only when AL01 Low tank level is generated.

7.3 Troubleshooting

7.3.1 Alarm contents, causes and remedies

The troubleshooting method depends which alarm has been generated. Refer to "Table 7-1 Alarm code list and Troubleshooting".

This page explains how to reset the alarm signal condition after eliminating the cause of the alarm.

- Ensure that the alarm display screen is displayed. Alarm can only be reset on this screen.
- Press [▼] and [▲] keys down simultaneously..
- The alarm is reset.

The [ALARM] lamp goes off.

The operation panel displays the circulating fluid temperature and the circulating fluid set temperature.

The contact signal of the contact input/output communication stops.

(Refer to the Operation Manual for communication for details.)

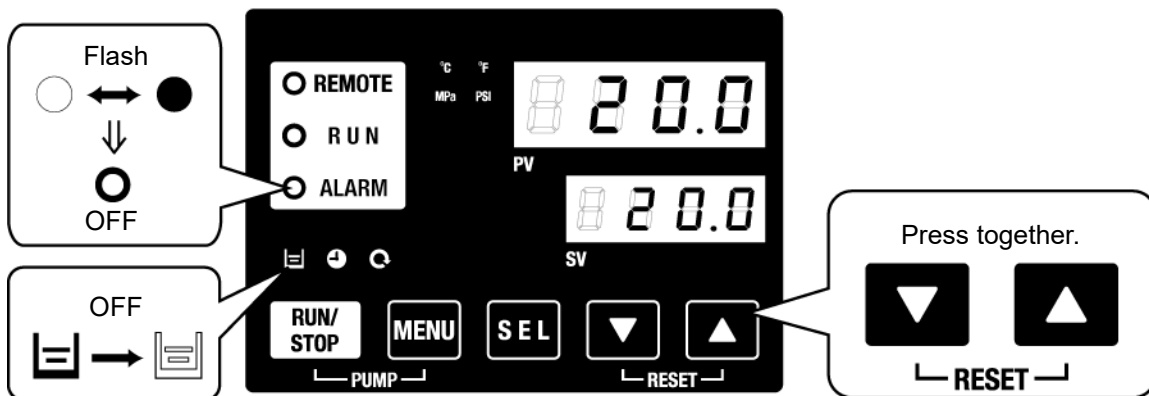

* [ lamp lights only when AL01 Low tank level is generated.

- The alarm operations that are the status of the product when alarms occurs can be changed. Refer to 5.20 Alarm customizing function.

- A.STP : Stops the pump, compressor and fan with the alarm.
- A.RUN : Continues running the pump, compressor and fan with the alarm.
- P.RUN : Stops the compressor and fan, and continues running the pump with the alarm.
- OFF : Does not generate the alarm.

* Stops the fan on the product of air cooled type only.

Table 7-1 Alarm code list and Troubleshooting (1/3)

Code	Alarm name	Alarm operation (default setting)	Cause / Remedy (Press the reset key after eliminating the cause.)
AL01	Low level in tank	A.RUN	The fluid level of the level indicator has fallen. Fill the circulating fluid.
AL02	High circulating fluid discharge temp.	A.STP	·Check that the ambient temperature, facility water specifications and heat load are within the specified ranges. ·Wait until the circulating fluid temperature lowers.
AL03	Circulating fluid discharge temp. rise	A.RUN	
AL04	Circulating fluid discharge temp. drop	A.RUN	Check that the filled circulating fluid temperature is within the specified range.
AL05	High circulating fluid return temp.	A.STP	·Check that the circulating fluid flows. · Check that the heat load is within the specified range.
AL06	High circulating fluid discharge pressure	A.STP	Check that there is no bend, collapse and clog on/in the external piping.
AL07	Abnormal pump operation	A.STP	The pump does not operate. Check that the pump thermal operation switch is operated.
AL08	Circulating fluid discharge pressure rise	A.RUN	Check that there is no bend, collapse and clog on/in the external piping. In case of displaying EEEE on the PI display of the main display and check monitor menu, the pressure sensor of the circulating fluid circuit has a malfunction. Ask the service.
AL09	Circulating fluid discharge pressure drop	A.RUN	Restart and check if the pump runs. In case of displaying EEEE on the PI display of the main display and check monitor menu, the pressure sensor of the circulating fluid circuit has a malfunction. Ask the service.
AL10	High compressor suction temp.	P.RUN	·Check the returned circulating fluid temperature. · Check that the heat load is within the specified range.
AL11	Low compressor suction temp.	P.RUN	·Check that the circulating fluid flows. ·Use 15% ethylene glycol aqueous solution with the set temperature lower than 10 deg. C.
AL12	Low super heat temperature	P.RUN	
AL13	High compressor discharge pressure	P.RUN	Check that the ambient temperature, facility water specifications and heat load are within the specified ranges.
AL15	Refrigerant circuit pressure (high pressure side) drop	P.RUN	Malfunction of the refrigeration circuit occurred. Ask for the service.
AL16	Refrigerant circuit pressure (low pressure side) rise	P.RUN	Check that the ambient temperature, facility water specifications and heat load are within the specified ranges.
AL17	Refrigerant circuit pressure (low pressure side) drop	P.RUN	·Check that the circulating fluid flows higher than the minimum operating flow rate. ·It is possible that refrigerant is leaking. Ask for the service.
AL18	Compressor running failure	P.RUN	Restart and check if the compressor runs after leaving for 10 minutes.

Table 7-2 Alarm code list and Troubleshooting (2/3)

Code	Alarm name	Alarm operation*1 (Default setting)	Cause / Remedy (Press the reset key after eliminating the cause.)
AL19	Communication error	OFF	No request message is sent from the host computer. Send it again.
AL20	Memory error	A.STP	Malfunction of the controller occurred. Ask for the service.
AL21	DC line fuse cut	A.STP	Fuse for the power supply output of the contact input/output connector has blown. · Ask for the service. · Check that there is no incorrect wiring and the current load is within the specified range.
AL22	Circulating fluid discharge temp. sensor failure	A.STP	Malfunction of the temperature sensor occurred. Ask for the service.
AL23	Circulating fluid return temp. sensor failure	A.STP	
AL24	Compressor suction temp. sensor failure	P.RUN	
AL25	Circulating fluid discharge pressure sensor failure	A.STP	Malfunction of the pressure sensor for the circulating fluid circuit occurred. EEEE is displayed on the PI display of the main display and check monitor display. Ask for the service.
AL26	Compressor discharge pressure sensor failure	P.RUN	Malfunction of the pressure sensor for the refrigeration circuit occurred. Ask for the service.
AL27	Compressor suction pressure sensor failure	P.RUN	
AL28	Pump maintenance	OFF	Notices of the periodical maintenances.
AL29*2	Fan maintenance	OFF	Ask for the services of the pump, fan and/or compressor.
AL30	Compressor maintenance	OFF	
AL31	Contact input 1 signal detection	A.STP	Contact input is detected.
AL32	Contact input 2 signal detection	A.STP	
AL37	Compressor discharge temp. sensor failure	P.RUN	Malfunction of the temperature sensor occurred. Ask for the service.
AL38	Compressor discharge temp. rise	P.RUN	Check that the ambient temperature, facility water specifications and heat load are within the specified ranges.
AL39	Internal unit fan stoppage	A.RUN	Malfunction of the internal unit fan occurred. Ask for the service.

*5: Pump maintenance alarm occurs at 20,000hours, but mechanical seal replacement is recommended every 8,000 hours.

Table 7-3 Alarm code list and Troubleshooting (3/3)

Code	Alarm name	Alarm operation*1 (Default setting)	Cause / Remedy (Press the reset key after eliminating the cause.)	
AL40 *2	Dust-proof maintenance filter	OFF	Notice of the periodical maintenance. Clean the dust-proof filter.	Every 500h*3
AL41	Power stoppage	A.STP	The power was shut off during running. Restart after checking the power supply.	
AL42	Compressor waiting	A.RUN	The system is waiting for the compressor to be ready to run. Wait for a while. Will be automatically released after running.	
AL43 *2	Fan breaker trip	P.RUN	Check that there is no power failure such as ground fault, short circuit, voltage fluctuation, abnormal interphase voltage, open phase, surge.	Release the fan breaker trip referring to [6.3.2 How to release the fan breaker trip].
AL44 *2	Fan inverter error	P.RUN		
AL45 *1	Compressor breaker trip	P.RUN		Keep the [▼] and [▲] keys of the operation display panel pressed down simultaneously for 10 seconds to reset. After resetting AL48, WAIT(W A I T) will be displayed and the product cannot run for 40 seconds. Restart 40 seconds later after resetting.
AL46	Compressor inverter error	P.RUN		
AL47 *1	Pump breaker trip	A.STP		
AL48	Pump inverter error	A.STP		
AL49 *4	Air exhaust fan stoppage	A.RUN	Air exhaust fan failure. Ask for service for the air exhaust fan.	

*1: This alarm does not occur on the product of power specification '-20'. (Except option S.)

*2: This alarm does not occur on the product of water cooled type.

*3: Change the setting within the range of 1 to 9999.

*4: This alarm does not occur on the product of air cooled type.

7.3.2 How to release the fan breaker trip

⚠ WARNING

! Be sure to lock out and tag out the breaker of the facility power supply (customer power supply facility) before wiring.

1. Shut of the breaker of the customer's power supply facility.
2. Remove 12 screws to remove the upper panel.

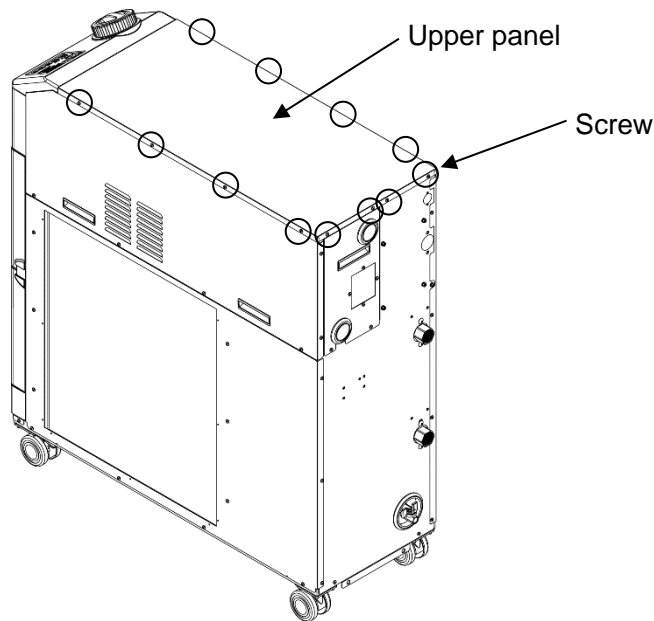

Fig. 7-1 Removal of upper panel

3. Remove 7 screws to remove the panel for electrical unit.

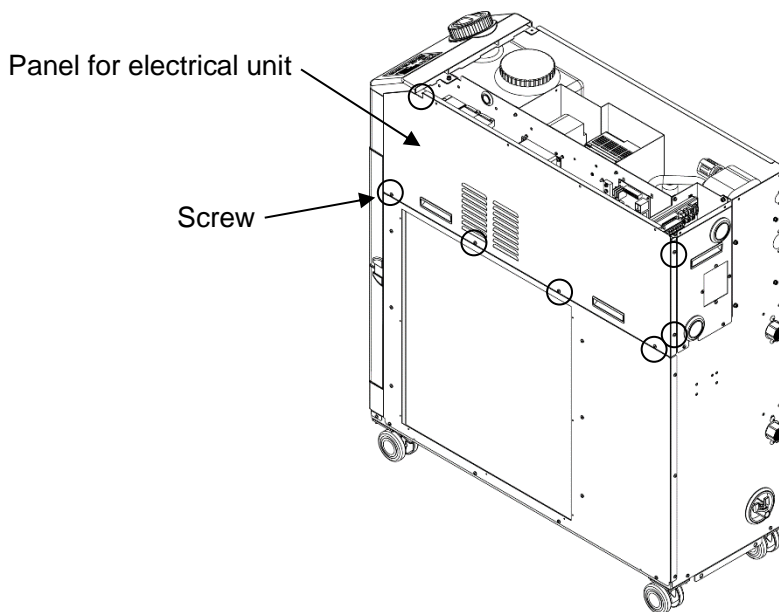

Fig. 7-2 Remove the panel of the electrical unit

4. Confirm if the fan breaker is tripped. If tripped, make it ON by pressing the black lever.

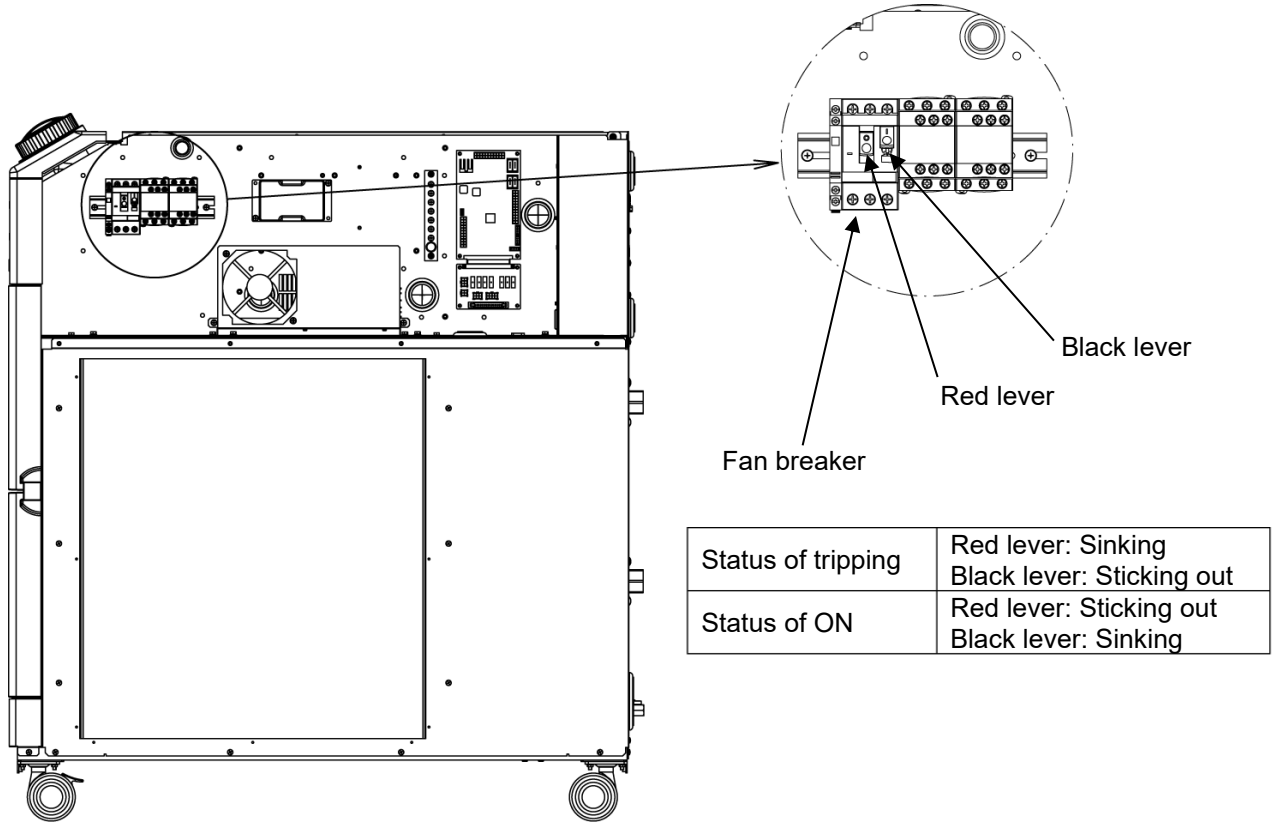

Fig. 7-3 Breaker location and statuses

5. Mount the panel for electrical unit and the upper panel in the reverse order of the removal.

⚠ WARNING

! Be sure to fasten the front panel of the electrical unit before turn on the breaker of the facility power supply (customer power supply facility). Otherwise it may cause an electrical shock and death.

7.3.3 How to release the pump thermal trip

⚠ WARNING



Be sure to lock out and tag out the breaker of the facility power supply (customer power supply facility) before wiring.

1. Shut of the breaker of the customer's power supply facility.

2. Remove 12 screws to remove the upper panel.

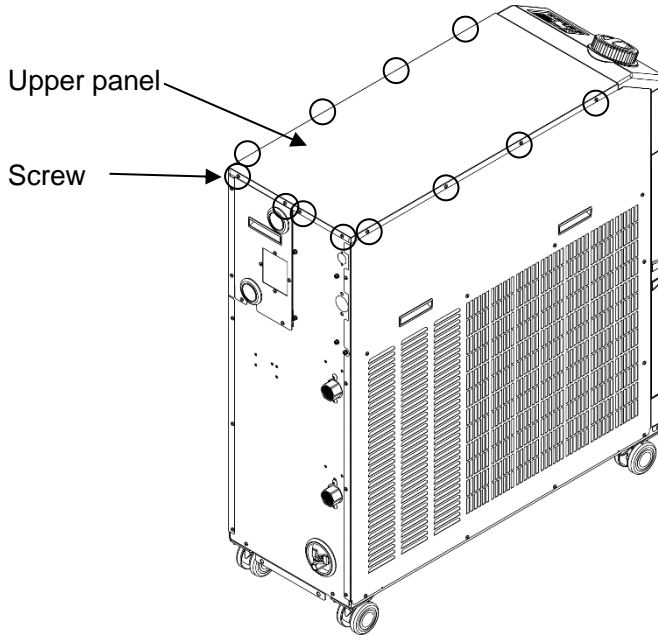

Fig. 7-4 Removal of upper panel

3. Remove 15 screws to remove the side panel.

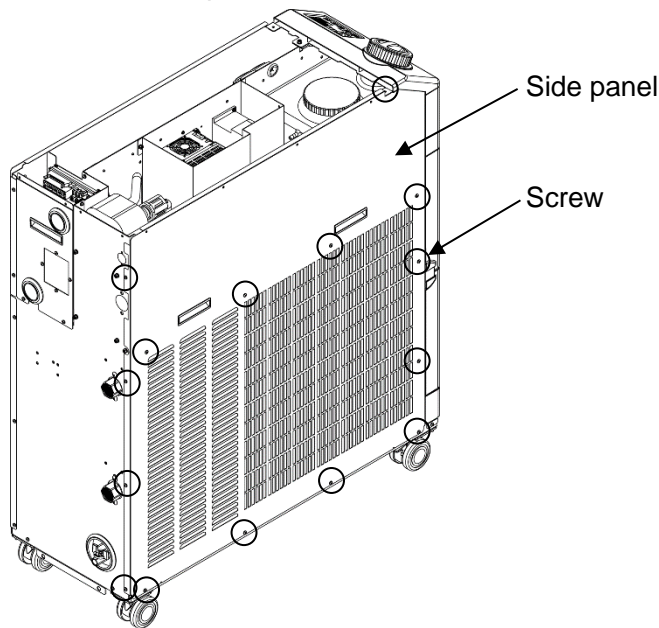

Fig. 7-5 Removal of side panel

4. Check if the pump thermal switch is tripped.

Pump thermal switch is under the rubber cover.

When you feel the pump thermal switch directly under the cover, the switch is tripped.

If you press the switch from the cover and you do not feel the switch head directly under the cover, the tripping is released.

(You cannot see if the pump thermal switch is tripped from the appearance)

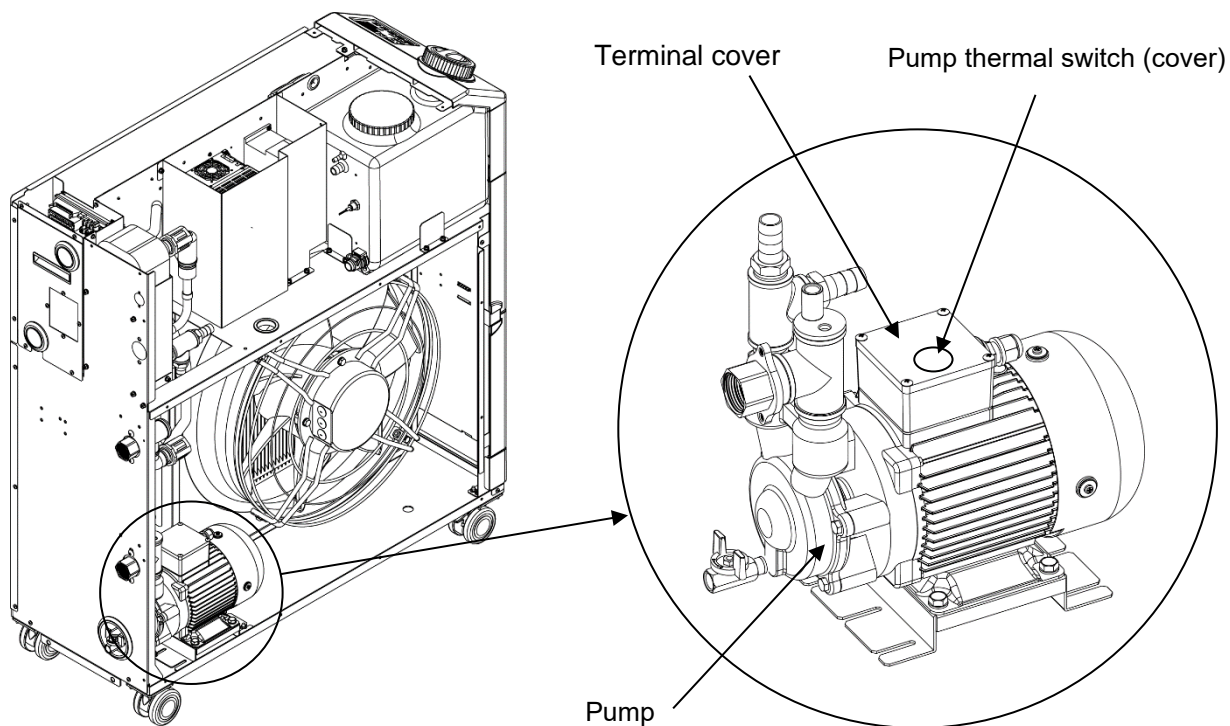

Fig. 7-6 Pump thermal switch position and condition

5. Mount the side panel and the upper panel in the reverse order of the removal.

7.4 Other Errors

■ How to check other errors

The causes and remedies for failures that are not indicated by alarm numbers are shown in "Table 7-4".

Table 7-4 Causes and remedies for failures without alarm number

Content of failure	Cause	Remedy
The operation panel displays nothing	The breaker of the customer's power supply or/and the optional breaker is/are not turned on.	Turn on the breaker.
	Failure of the breaker of the customer's power supply or/and optional power supply.	Replace the breaker.
	No power supply (The breaker for the power supply is not turned on.)	Supply the power.
	Breaker trip of the customer's power supply or/and the optional breaker due to short-circuit and current leakage	Repair the short-circuit or current leaking part.
The [RUN] LED does not light up even when the [RUN/STOP] switch is pressed.	Communication is set.	Check the presence of communication setting.
	Failure of the [RUN] LED	Replace the controller.
	Failure of the [RUN/STOP] switch	Replace the controller.

Chapter 8 Control, Inspection and Cleaning

8.1 Control of Circulating Fluid, facility water Quality

WARNING



Use specified circulating fluids only. If other fluids are used, they may damage the product or result in dangerous hazards. When using clean water (tap water) ensure that it satisfies the water standard shown in the table below. If the water quality standards are not met, clogging or leakage in the facility water piping, or other problems such as refrigerant leakage, etc., may result.

Table 8-1 Quality standard for clean water (tap water)

	Item	Unit	Standard value	
			For circulating fluid	For facility water
Standard item	pH (at 25°C)	—	6.0 to 8.0	6.5 to 8.2
	Electric conductance (at 25°C)	[μ S/cm]	100 to 300	100 to 800
	Chloride ion	[mg/L]	50 or less	200 or less
	Sulfuric acid ion	[mg/L]	50 or less	200 or less
	Acid consumption (at pH 4.8)	[mg/L]	50 or less	100 or less
	Total hardness	[mg/L]	70 or less	200 or less
	Calcium hardness	[mg/L]	50 or less	150 or less
	Ion silica	[mg/L]	30 or less	50 or less
Referential item	Iron	[mg/L]	0.3 or less	1.0 or less
	Copper	[mg/L]	0.1 or less	0.3 or less
	Sulfide ion	[mg/L]	Not detected	Not detected
	Ammonium ion	[mg/L]	0.1 or less	1.0 or less
	Residual chlorine	[mg/L]	0.3 or less	0.3 or less
	Separation carbonic acid	[mg/L]	4.0 or less	4.0 or less

* Quoted from JRA-GL-02-1994, The Japan Refrigeration and Air Conditioning Industry Association.

CAUTION



Change the circulating fluid in the tank if any problems are found during the regular check. Additionally, even if no problems are found, it is necessary to change the fluid once every 3 months because evaporation of the fluid causes concentrations of impurities. Refer to the page containing "8.2 Inspection and Cleaning" for the regular check.

8.2 Inspection and Cleaning

⚠ WARNING



- Do not operate switches, etc. with wet hands and do not touch the electrical parts such as the power supply plug. It might cause electric shock.
- Do not splash water directly on the product and do not wash with water. It might cause electric shock and fire, etc.
- Do not touch the fins directly when cleaning the dustproof filter. It might cause injury.

⚠ WARNING



- Shut off the power supply of the product when performing cleaning, maintenance or inspection. It might cause electric shock, injury or burn, etc.
- Replace all panels removed for inspection or cleaning. It might cause injury or electric shock if it is operated with the panel removed or open. Do not operate switches, etc. with wet hands and do not touch the electrical parts such as the power supply plug. It might cause electric shock.

8.2.1 Daily check

Check each item of Table 8-2 below, and if any error is seen, stop the operation of the product and turn off the user's power supply, and service the product.

Table 8-2 Contents of daily check

Item	Content of check	
Installation condition	Check the installation conditions of the product.	There is no heavy object on the product or excessive force on the piping.
		Temperature is within the specified range of the product.
Fluid leakage	Check the connected part of piping	There is no circulating fluid leakage from the connected part of piping.
Fluid amount	Check the liquid level indicator.	The circulating fluid must enter the scale of "H".
Operation panel	Check the display.	The numbers on the display are clear.
	Check the function.	The [RUN/STOP] and [MENU], [SEL], [▼], [▲] buttons operate properly.
Circulating fluid temperature	Check on the operation panel.	There is no problem for use.
Operating conditions	Check the operation condition.	There is no abnormal noise, vibration, smell and smoke.
Ventilating condition (Air-cooled refrigerating type)	Check the condition of the ventilation grille.	Make sure the ventilation grille is not obstructed.
Facility water (water cooled type)	Facility water condition	Temperature, pressure and flow rate are within the specified range of the product.

8.2.2 Monthly check

■ Cleaning of air ventilation (In case of air cooled type.)

CAUTION



- If the air ventilation of the product have clogged with dust or debris, heat radiation performance reduces. This results in the reduction of cooling performance, and may stop the operation.

Clean the dust-proof filter with a long bristled brush or by air purging to prevent the fins from being deformed or damaged.

■ Cleaning of the dust-proof filter

1. Dustproof filter is installed on the right side of the chiller.
2. Hold the pull at the bottom of the dustproof filter and lift the filter. Pull the filter forward, and lift it, then pull it downward. Care should be taken not to deform or scratch the air cooled condenser (fin) while the removal.

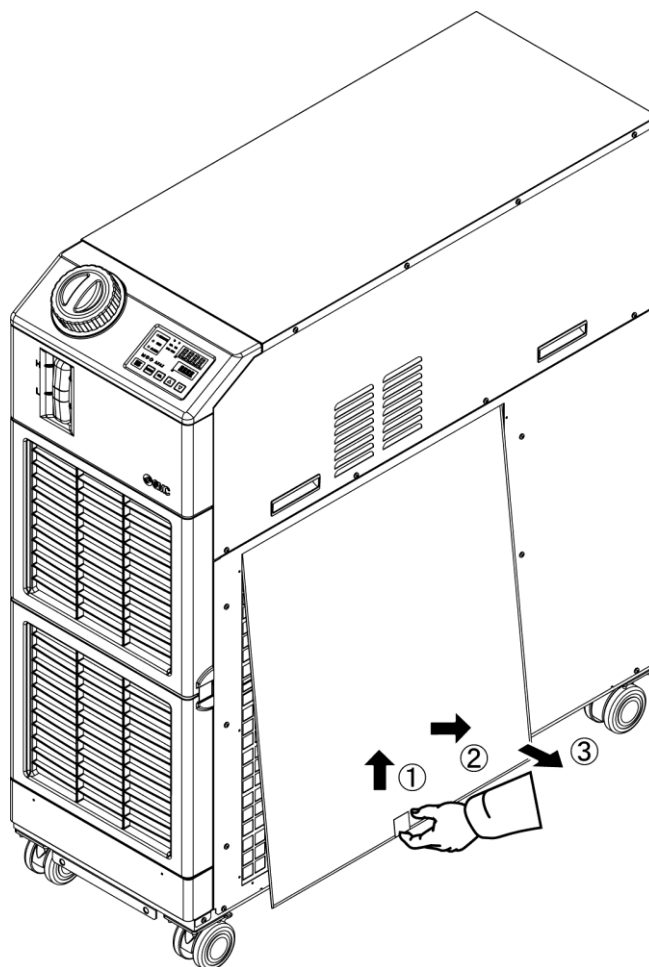

Fig. 8-1 Removal of the dust-proof filter

■ **Cleaning of dust-proof filter**

Clean the dust-proof filter with a long bristled brush or by air purging

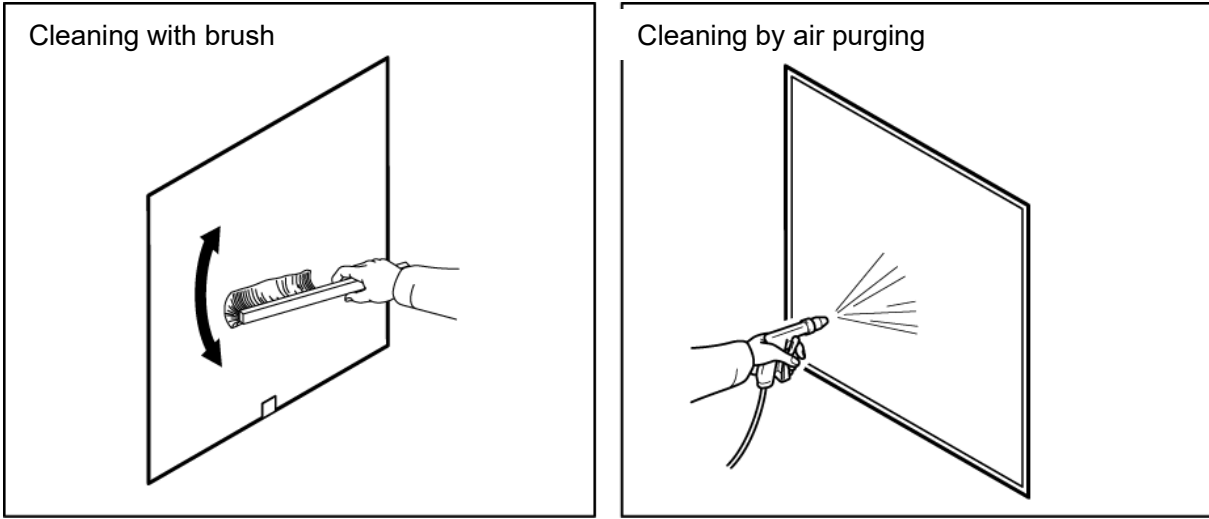

Fig. 8-2 Cleaning of dust-proof filter

■ **Mounting of dust-proof filter**

Insert the dust-proof filter in reverse order of removal.

8.2.3 Inspection every 3 months

■ **Circulating fluid exchanging**

- Exchange the circulating fluid to new one periodically. Otherwise it may get alga or decompose.
- Use the water as the circulating fluid that meets the quality specification written in “Table 8-1 Quality standard for clean water (tap water)”.
- In case of using the Y strainer of accesarry, clean the screen mesh in the strainer when exchanging the circulating fluid.

Confirm if there is no circulating fluid remained in the product, the customer’s machine and the piping.

Remove the cap cover of the strainer and take out the screen mesh.

Clean the screen mesh with detergent or/and purge by air. Take care not to make scratches at this time.

Do not use any chlorinated detergents and cleansers.

Put the screen mesh in the groove of the cap and assemble it to the strainer.

■ **Clean the customer's facility water system (water cooled type)**

- Clean the customer's facility water system and replace facility water.
- Supply facility water within the specified “Table 8-1”

CAUTION



If there are foreign matters or clogs in the screen mesh, the pressure loss will become large and it may break the screen mesh.

8.2.4 Inspection every 6 months

■ Check for water leakage from pump

Remove the panel and check the pump for excessive leakage. If the leakage is found, replace the mechanical seal. Order the mechanical seal described in "8.3 Consumables" as a service part.

CAUTION

- Leakage from the mechanical seal
It is impossible to prevent the leakage from the mechanical seal completely because of its structure. Although the leakage is described as 3cc/hr or less.
- The recommend life time of the mechanical seal before needing

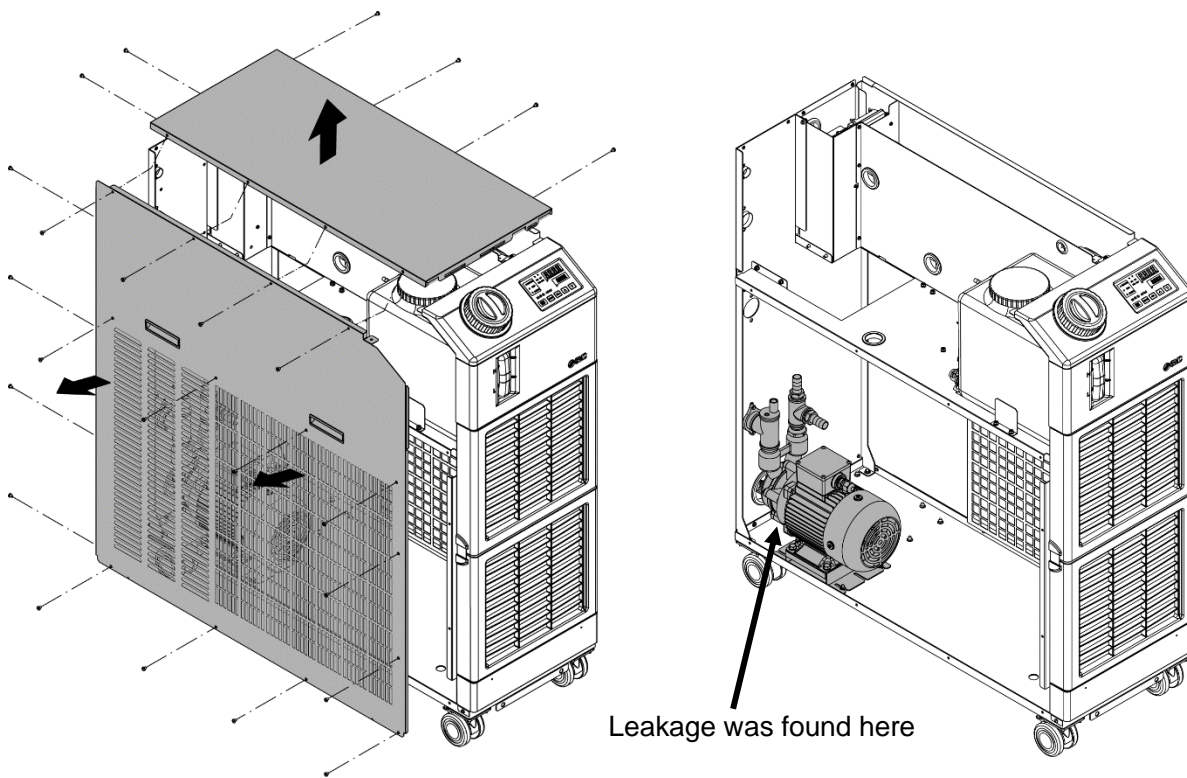



Fig. 8-3 Check for water leakage from pump

8.2.5 Inspection for winter season

CAUTION	
	<p>The power supply should be ON for these functions. Otherwise these functions cannot start.</p>

■ **Anti-freezing function**

To prevent the circulating fluid freezing during winter, this function operates pump automatically to heat the circulating fluid by the pump’s heat radiation. If there is a possibility of the circulating fluid freezing due to changes in the installation and operating environment (season and weather), set this function in advance.

*For details, refer to “5.11 Anti-freezing function”.

■ **Warming up function**

During winter or night, this function operates pump automatically to heat the circulating fluid by the pump’s heat radiation to keep the circulating fluid temperature around the warming up function set temperature. If it is necessary to shorten the circulating fluid temperature rising time, set this function in advance.

*For details, refer to “5.18 Warming up function”.

■ **For freezing of the facility water**

Please discharge the facility water from facility water circuit when there is fear of a freeze.

*For the details, refer to “8.4.2 Drain of the facility water”.

8.3 Consumables

Replace the following parts depending on their condition.

Table 8-3 Consumables

Part number	Name	Qty.	Remarks
HRS-S0306	Dust-proof filter	1	1 pc. is used per unit
HRS-S0307	Mechanical seal set	1	1 set is used per unit
HRS-S0350	Mechanical seal set	1	1 set is used per unit (For option M)

8.4 Stop for a Long Time

If there is a concern that the product will not be operated for a long period of time or there is a risk of freezing, conduct the following operations.

1. Shut off the breaker of the customer's power supply. (Turn of the breaker at the back of the product when option B [Earth leakage breaker] and HRS090-***-40-* is selected)

2. Drain the circulating fluid completely.
Please refer to "8.4.1 Drain of the circulating fluid" for the method of drain the circulating fluid from the product.

3. After draining, cover the product with a sheet and store. (Prepare the sheet.)

8.4.1 Drain of the circulating fluid

WARNING



- Stop the customer device and release the residual pressure before draining the circulating fluid.

CAUTION

- For relocation or long-term storage, drain the residual liquid in the piping as much as possible. Residual liquid may drip during movement or installation.

1. Shut off the breaker of the customer's power supply.

2. Place a container underneath the drain outlet.

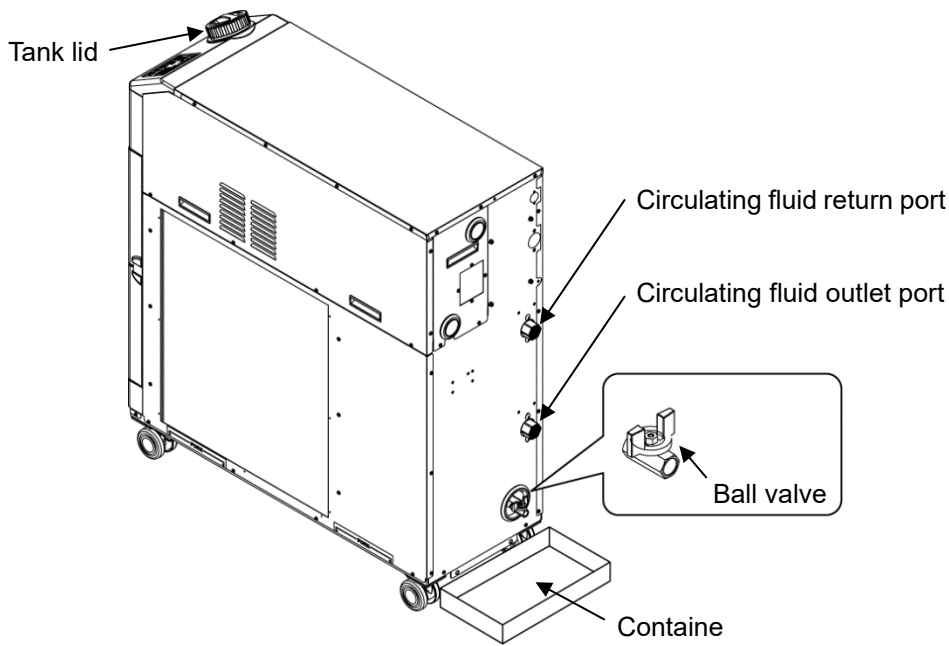

Fig. 8-4 Drain the circulating fluid

3. Remove the tank lid.

4. Open the ball valves of the drain port and drain the fluid.

5. Confirm that all the circulating fluid has been drained from the product and the user's machine and piping, and apply air purge from the circulating fluid return port.

6. After discharging the circulating fluid from the drain port, remove residual liquid in the tank using a syringe or waist cloth.

7. Close the ball valve and mount the tank lid.

■ **How to connect to the drain port**

When piping the drain port, hold the ball valve of the drain port with a wrench not to rotate it.

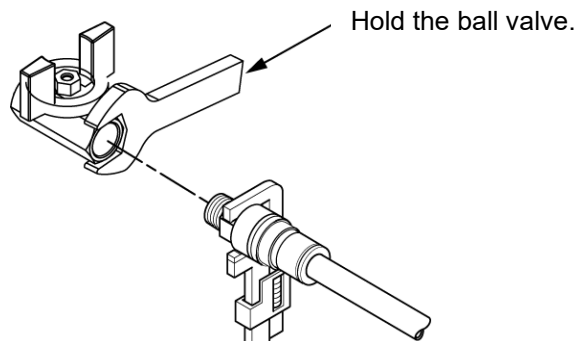

Fig. 8-5 Connection to the drain

CAUTION



Without holding the ball valve of the drain port with a wrench, the ball valve may rotate and it may cause a fluid leakage and malfunction of the product. Be sure to hold the ball valve of the drain port.

8.4.2 Drain of the facility water

⚠ WARNING



- Stop the customer device and release the residual pressure before draining the facility water.

CAUTION

- For relocation or long-term storage, drain the residual liquid in the piping as much as possible. Residual liquid may drip during movement or installation.

1. Shut off the breaker of the customer's power supply.
2. Stop supplying the facility water and make sure there is no pressure in the facility water piping.
3. Remove the facility water piping from the product.
4. Open the Left side panel then, open the air vent valve. The facility water in the product will be drained from the facility water inlet port.

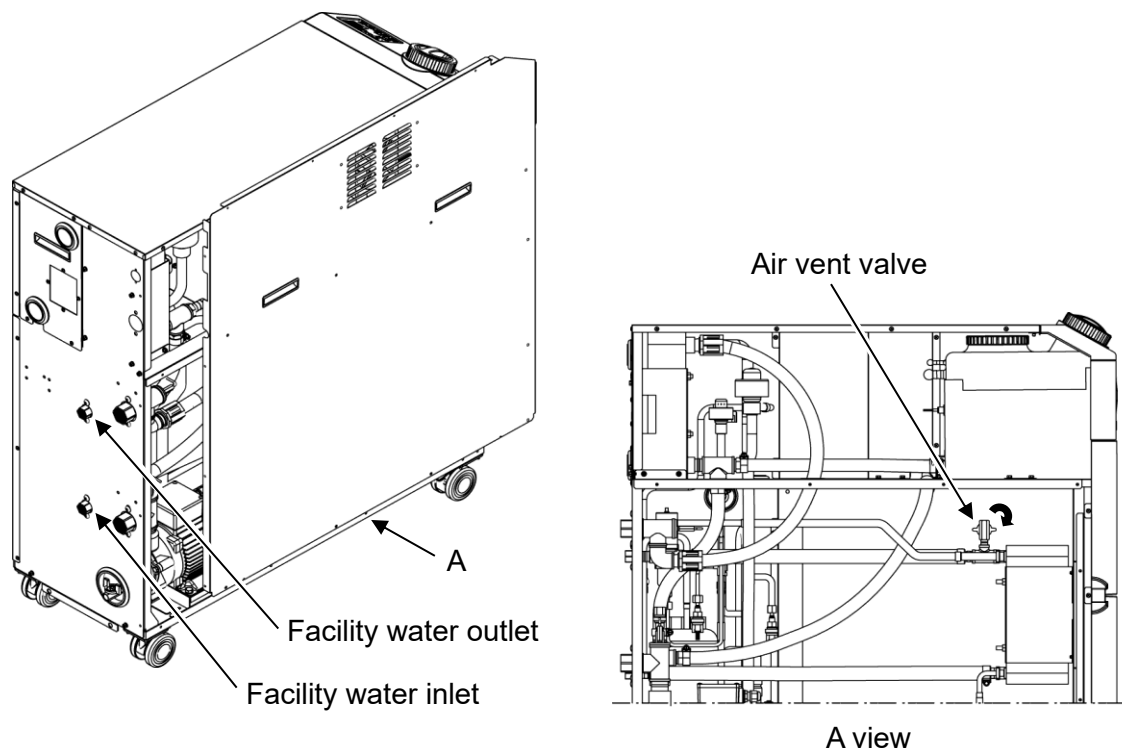

Fig. 8-6 Discharge of the facility water

5. After draining, shut the air vent valve and close the Left side panel.

Chapter 9 Documents

9.1 Specifications

9.1.1 HRSH090-A*-20-*

Table 9-1 Specifications [HRSH090-A*-20-*

Model		HRSH090-A*-20-*		
Cooling method		Air-cooled refrigerated type		
Refrigerant		R410A (HFC)		
Control method		PIDcontrol		
Ambient temperature* ¹ °C		5 to 45		
Circulating fluid system	Circulating fluid* ²		Tap water, Ethylene glycol aqueous solution 15%	
	Operating temperature range* ¹ °C		5 to 40	
	Cooling capacity* ³ kW		9.5	
	Heating capacity* ⁴ kW		2.5	
	Temperature stability* ⁵ °C		±0.1	
	Pump capacity	Rated flow rate (Outlet) L/min	45 (0.5MPa)	
		Maximum flow rate L/min	60	
		Maximum lifting height m	50	
	Settable pressure range* ⁶ MPa		0.1 to 0.5	
	Minimum operating flow rate* ⁷ L/min		20	
	Tank capacity L		18	
	Circulating fluid outlet, circulating fluid return port		Rc1 (Symbol F: G1, Symbol N: NPT1)	
	Tank drain port		Rc1/4 (Symbol F: G1/4, Symbol N: NPT1/4)	
Wetted material* ¹⁰		Stainless, Copper(Heat exchanger's brazing), Bronze, Brass, Carbon, Ceramic, PE, PVC, POM, PTFE, NBR, EPDM, FKM, PP		
Electric system	Power supply			
	AC200/200-230V 50/60Hz 3phase Allowable voltage fluctuation ±10% (No continuous voltage fluctuation)			
	Recommended earth leakage breaker* ⁸	Rated current A	30	
		Sensitivity mA	30	
		Rated operating current* ⁵ A	15	
	Rated power consumption* ⁵ kW (kVA)	4.6 (5.0)		
Sound level (Front 1m / Height 1m)* ⁵ dB(A)		66		
Accessory		Alarm cord list label 2pc.(English 1pc./Japanese 1pc.), Operation manual 2pc. (English 1pc./Japanese 1pc.), Y strainer (40 meshes) 25A, Barrel nipple 25A Anchor brackets 2pcs.(including M10 bolts 4pcs.)* ⁹		
Weight (dry condition) kg		Approx.130		

- *1 Use 15% ethylene glycol aqueous solution if operating in a place where the circulating fluid temp. or ambient temperature is lower than 10 °C
- *2 Use fluid in condition below as the circulating fluid.
Tap water: Standard of The Japan Refrigeration And Air Conditioning Industry Association (JRA GL-02-1994)
15% ethylene glycol aqueous solution: diluted by tap water in condition above without any additives such as antiseptics.
Deionized water: Conductivity 1μS/cm and higher (electrical resistivity 1MΩ·cm and lower)
- *3 (1)Operating ambient temp.: 32 °C, (2)Circulating fluid : Tap water, (3)Circulating fluid temp.: 20 °C, (4)Circulating fluid flow rate : Rated flow rate, (5)Power supply: AC200V
- *4 (1)Operating ambient temp.: 32 °C, (2)Circulating fluid : Tap water, (3)Circulating fluid flow rate : Rated flow rate, (4)Power supply: AC200V
- *5 (1)Operating ambient temp.: 32 °C, (2)Circulating fluid : Tap water, (3)Circulating fluid temp.: 20 °C, (4)Heat load : Same as the cooling capacity, (5)Circulating fluid flow rate: Rated flow rate, (6)Power : AC200V, (7) External piping length: Minimum.
- *6 With the pressure control mode of the pump operation mode. When the pressure control mode is not necessary, use the frequency set mode
- *7 Fluid flow rate to maintain the cooling capacity. If the actual flow rate is lower than this, please install a bypass piping.
- *8 To be prepared by the customer. A specified earth leakage breaker is installed for option B [Earth leakage breaker] or option S [CE/UL] of each model.
- *9 The anchor brackets (including M10 bolts) are used for fixation with the skid when this product is packed. The anchor bolts are not attached.
- *10 Copper, bronze and brass is not included when option M [DI water (pure water) piping] is selected.

9.1.2 HRSH090-A*-40-*

Table 9-2 Specifications [HRSH090-A*-40-*]

Model		HRSH090-A*-40-*		
Cooling method		Air-cooled refrigerated type		
Refrigerant		R410A (HFC)		
Control method		PIDcontrol		
Ambient temperature*1 °C		5 to 45		
Circulating fluid system	Circulating fluid*2		Tap water, Ethylene glycol aqueous solution 15%	
	Operating temperature range*1 °C		5 to 40	
	Cooling capacity*3 kW		9.5	
	Heating capacity*4 kW		2.5	
	Temperature stability*5 °C		±0.1	
	Pump capacity	Rated flow rate (Outlet) L/min	45 (0.5MPa)	
		Maximum flow rate L/min	60	
		Maximum lifting height m	50	
	Settable pressure range*6 MPa		0.1 to 0.5	
	Minimum operating flow rate*7 L/min		20	
	Tank capacity L		18	
	Circulating fluid outlet, circulating fluid return port		Rc1 (Symbol F: G1, Symbol N: NPT1)	
	Tank drain port		Rc1/4 (Symbol F: G1/4, Symbol N: NPT1/4)	
Wetted material*10		Stainless, Copper(Heat exchanger's brazing), Bronze, Brass, Carbon, Ceramic, PE, PVC, POM, PTFE, NBR, EPDM, FKM, PP		
Electric system	Power supply		AC380-415V 50/60Hz 3phase Allowable voltage fluctuation ±10% (No continuous voltage fluctuation) AC460-480V 60Hz 3-phase Allowable voltage fluctuation +4%, -10% (Max. voltage less than 500 V and no continuous voltage fluctuation)	
	Recommended earth leakage breaker*8	Rated current A	20	
		Sensitivity mA	30	
	Rated operating current*5 A		8	
	Rated power consumption*5 kW (kVA)		5.0 (5.6)	
Sound level (Front 1m / Height 1m)*5 dB(A)		66		
Accessory		Alarm cord list label 2pc.(English 1pc./Japanese 1pc.), Operation manual 2pc. (English 1pc./Japanese 1pc.), Y strainer (40 meshes) 25A, Barrel nipple 25A, Anchor brackets 2pcs.(including M10 bolts 4pcs.)*9		
Weight (dry condition) kg		Approx.130		

- *1 Use 15% ethylene glycol aqueous solution if operating in a place where the circulating fluid temp. or ambient temperature is lower than 10 °C
- *2 Use fluid in condition below as the circulating fluid.
Tap water: Standard of The Japan Refrigeration And Air Conditioning Industry Association (JRA GL-02-1994)
15% ethylene glycol aqueous solution: diluted by tap water in condition above without any additives such as antiseptics.
Deionized wate: Conductivity 1µS/cm and higher (electrical resistivity 1MΩ·cm and lower)
- *3 (1)Operating ambient temp.: 32 °C, (2)Circulating fluid : Tap water, (3)Circulating fluid temp.: 20 °C, (4)Circulating fluid flow rate : Rated flow rate, (5)Power supply: AC400V
- *4 (1)Operating ambient temp.: 32 °C, (2)Circulating fluid : Tap water, (3)Circulating fluid flow rate : Rated flow rate, (4)Power supply: AC400V
- *5 (1)Operating ambient temp.: 32 °C, (2)Circulating fluid : Tap water, (3)Circulating fluid temp.: 20 °C, (4)Heat load : Same as the cooling capacity, (5)Circulating fluid flow rate: Rated flow rate, (6)Power : AC400V, (7) External piping length: Minimum.
- *6 With the pressure control mode of the pump operation mode. When the pressure control mode is not necessary, use the frequency set mode
- *7 Fluid flow rate to maintain the cooling capacity. If the actual flow rate is lower than this, please install a bypass piping.
- *8 A specified earth leakage breaker is installed for HRSH090-A*-40-*
- *9 The anchor brackets (including M10 bolts) are used for fixation with the skid when this product is packed. The anchor bolts are not attached.
- *10 Copper, bronze and brass is not included when option M [DI water (pure water) piping] is selected.

9.1.3 HRSH090-W*-20-*

Table 9-3 Specifications [HRSH090-W*-20-*]

Model		HRSH090-W*-20-*		
Cooling method		Water-cooled refrigerated type		
Refrigerant		R410A (HFC)		
Control method		PIDcontrol		
Ambient temperature* ¹ °C		5 to 45		
Circulating fluid system	Circulating fluid* ²		Tap water, Ethylene glycol aqueous solution 15%	
	Operating temperature range* ¹ °C		5 to 40	
	Cooling capacity* ³ kW		11.0	
	Heating capacity* ⁴ kW		2.5	
	Temperature stability* ⁵ °C		±0.1	
	Pump capacity	Rated flow rate (Outlet) L/min	45 (0.5MPa)	
		Maximum flow rate L/min	60	
		Maximum lifting height m	50	
	Settable pressure range* ⁶ MPa		0.1 to 0.5	
	Minimum operating flow rate* ⁷ L/min		20	
	Tank capacity L		18	
	Circulating fluid outlet, circulating fluid return port		Rc1 (Symbol F: G1, Symbol N: NPT1)	
	Tank drain port		Rc1/4 (Symbol F: G1/4, Symbol N: NPT1/4)	
Wetted material* ¹⁰		Stainless, Copper(Heat exchanger's brazing), Bronze, Brass, Carbon, Ceramic, PE, PVC, POM, PTFE, NBR, EPDM, FKM, PP		
Facility water system	Temperature range °C		5 to 40	
	Pressure range MPa		0.3 to 0.5	
	Required flow L/min		25	
	Facility water pressure differential MPa		more than 0.3	
	Facility water inlet, outlet port		Rc1/2	
Wetted material		Stainless, Copper(Heat exchanger's brazing), Bronze, Brass PTFE, NBR, EPDM		
Electric system	Power supply		AC200/200-230V 50/60Hz 3phase Allowable voltage fluctuation ±10% (No continuous voltage fluctuation)	
	Recommended earth leakage breaker* ⁸	Rated current A	30	
		Sensitivity mA	30	
	Rated operating current* ⁵ A		12	
Rated power consumption* ⁵ kW (kVA)		3.8 (4.0)		
Sound level (Front 1m / Height 1m)* ⁵ dB(A)		65		
Accessory		Alarm cord list label 2pc.(English 1pc./Japanese 1pc.), Operation manual 2pc. (English 1pc./Japanese 1pc.), Y strainer (40 meshes) 25A, Barrel nipple 25A Anchor brackets 2pcs.(including M10 bolts 4pcs.)* ⁹		
Weight (dry condition) kg		Approx. 121		

*1 Use 15% ethylene glycol aqueous solution if operating in a place where the circulating fluid temp. or ambient temperature is lower than 10 °C. Please discharge the facility water from the facility water circuit when there is a risk of freezing.

*2 Use fluid in condition below as the circulating fluid.

Tap water: Standard of The Japan Refrigeration And Air Conditioning Industry Association (JRA GL-02-1994)

15% ethylene glycol aqueous solution: diluted by tap water in condition above without any additives such as antiseptics.

Deionized water: Conductivity 1μS/cm and higher (electrical resistivity 1MΩ·cm and lower)

*3 (1) Facility water temp. : 32 °C, (2)Circulating fluid : Tap water, (3)Circulating fluid temp.: 20 °C, (4)Circulating fluid flow rate : Rated flow rate, (5)Power supply: AC200V

*4 (1) Facility water temp. : 32 °C, (2)Circulating fluid : Tap water, (3)Circulating fluid flow rate : Rated flow rate, (4)Power supply: AC200V

*5 (1) Facility water temp. : 32 °C, (2)Circulating fluid : Tap water, (3)Circulating fluid temp.: 20 °C, (4)Heat load : Same as the cooling capacity, (5)Circulating fluid flow rate: Rated flow rate, (6)Power : AC200V, (7) External piping length: Minimum.

*6 With the pressure control mode of the pump operation mode. When the pressure control mode is not necessary, use the frequency set mode

*7 Fluid flow rate to maintain the cooling capacity. If the actual flow rate is lower than this, please install a bypass piping.

*8 To be prepared by the customer. A specified earth leakage breaker is installed for option B [Earth leakage breaker] or option S [CE/UL] of each model.

*9 The anchor brackets (including M10 bolts) are used for fixation with the skid when this product is packed. The anchor bolts are not attached.

*10 Copper, bronze and brass is not included when option M [DI water (pure water) piping] is selected.

9.1.4 HRSH090-W*-40-*

Table 9-4 Specifications [HRSH090-W*-40-*

Model		HRSH090-W*-40-*		
Cooling method		Water-cooled refrigerated type		
Refrigerant		R410A (HFC)		
Control method		PIDcontrol		
Ambient temperature*1 °C		5 to 45		
Circulating fluid system	Circulating fluid*2		Tap water, Ethylene glycol aqueous solution 15%	
	Operating temperature range*1 °C		5 to 40	
	Cooling capacity*3 kW		11.0	
	Heating capacity*4 kW		2.5	
	Temperature stability*5 °C		±0.1	
	Pump capacity	Rated flow rate (Outlet) L/min	45 (0.5MPa)	
		Maximum flow rate L/min	60	
		Maximum lifting height m	50	
	Settable pressure range*6 MPa		0.1 to 0.5	
	Minimum operating flow rate*7 L/min		20	
	Tank capacity L		18	
	Circulating fluid outlet, circulating fluid return port		Rc1 (Symbol F: G1, Symbol N: NPT1)	
	Tank drain port		Rc1/4 (Symbol F: G1/4, Symbol N: NPT1/4)	
Wetted material*10		Stainless, Copper(Heat exchanger's brazing), Bronze, Brass, Carbon, Ceramic, PE, PVC, POM, PTFE, NBR, EPDM, FKM, PP		
Facility water system	Temperature range °C		5 to 40	
	Pressure range MPa		0.3 to 0.5	
	Required flow L/min		25	
	Facility water pressure differential MPa		more than 0.3	
	Facility water inlet, outlet port		Rc1/2	
Wetted material		Stainless, Copper(Heat exchanger' s brazing), Bronze, Brass PTFE, NBR, EPDM		
Electric system	Power supply		AC380-415V 50/60Hz 3phase Allowable voltage fluctuation ±10% (No continuous voltage fluctuation) AC460-480V 60Hz 3-phase Allowable voltage fluctuation +4%, -10% (Max. voltage less than 500 V and no continuous voltage fluctuation)	
	Recommended earth leakage breaker*8	Rated current A	20	
		Sensitivity mA	30	
	Rated operating current *5 A		6.8	
	Rated power consumption *5 kW (kVA)		4.0 (4.7)	
Sound level (Front 1m / Height 1m) *5 dB(A)		65		
Accessory		Alarm cord list label 2pc.(English 1pc./Japanese 1pc.), Operation manual 2pc. (English 1pc./Japanese 1pc.), Y strainer (40 meshes) 25A, Barrel nipple 25A, Anchor brackets 2pcs.(including M10 bolts 4pcs.)*9		
Weight (dry condition) kg		Approx.121		

- *1 Use 15% ethylene glycol aqueous solution if operating in a place where the circulating fluid temp. or ambient temperature is lower than 10 °C. Please discharge the facility water from the facility water circuit when there is a risk of freezing.
- *2 Use fluid in condition below as the circulating fluid.
Tap water: Standard of The Japan Refrigeration And Air Conditioning Industry Association (JRA GL-02-1994)
15% ethylene glycol aqueous solution: diluted by tap water in condition above without any additives such as antiseptics.
Deionized wate: Conductivity 1µS/cm and higher (electrical resistivity 1MΩ·cm and lower)
- *3 (1) Facility water temp. : 32 °C, (2)Circulating fluid : Tap water, (3)Circulating fluid temp.: 20 °C, (4)Circulating fluid flow rate : Rated flow rate, (5)Power supply: AC400V
- *4 (1) Facility water temp. : 32 °C, (2)Circulating fluid : Tap water, (3)Circulating fluid flow rate : Rated flow rate, (4)Power supply: AC400V
- *5 (1) Facility water temp. : 32 °C, (2)Circulating fluid : Tap water, (3)Circulating fluid temp.: 20 °C, (4)Heat load : Same as the cooling capacity, (5)Circulating fluid flow rate: Rated flow rate, (6)Power : AC400V, (7) External piping length: Minimum.
- *6 With the pressure control mode of the pump operation mode. When the pressure control mode is not necessary, use the frequency set mode
- *7 Fluid flow rate to maintain the cooling capacity. If the actual flow rate is lower than this, please install a bypass piping.
- *8 A specified earth leakage breaker is installed for HRSH090-W*-40-*.
- *9 The anchor brackets (including M10 bolts) are used for fixation with the skid when this product is packed. The anchor bolts are not attached.
- *10 Copper, bronze and brass is not included when option M [DI water (pure water) piping] is selected.

9.1.5 Refrigerant with GWP reference

Table9-5 Refrigerant with GWP reference

Refrigerant	Global Warming Potential (GWP)	
	Regulation (EU) No 517/2014 (Based on the IPCC AR4)	Revised Fluorocarbons Recovery and Destruction Law (Japanese law)
R134a	1,430	1,430
R404A	3,922	3,920
R407C	1,774	1,770
R410A	2,088	2,090

Note:

1. This product is hermetically sealed and contains fluorinated greenhouse gases.
2. See specification table for refrigerant used in the product.

9.1.6 Communication specification

■ Regarding the communication specification, refer to the operation manual communication function, HRX-OM-R028.

■ Contact input/output

Table 9-6 Specifications List

Item		Specification												
Connector type		M3 terminal block												
Contact input signal	Insulation method	Photo coupler												
	Rated input voltage	DC24V												
	Input voltage range	DC 21.6V to 26.4V												
	Rated input current	5mA TYP												
	Input impedance	4.7kΩ												
Contact output signal	Rated load voltage	AC48V or less/DC30V or less												
	Maximum load current	AC/DC 500mA (Resistance load)												
	Minimum load current	DC5V 10mA												
DC24V power supply output		DC24V±10% 500mA MAX (No inductive load)												
Circuit structure diagram	<table border="1" style="margin-left: auto; margin-right: auto;"> <thead> <tr> <th>Signal description</th> <th>Default setting^{*1}</th> </tr> </thead> <tbody> <tr> <td>Contact input signal 2</td> <td>---</td> </tr> <tr> <td>Contact input signal 1</td> <td>Run/stop signal input</td> </tr> <tr> <td>Contact output signal 3</td> <td>Alarm status signal output</td> </tr> <tr> <td>Contact output signal 2</td> <td>Remote status signal output</td> </tr> <tr> <td>Contact output signal 1</td> <td>Operation status signal output</td> </tr> </tbody> </table>		Signal description	Default setting ^{*1}	Contact input signal 2	---	Contact input signal 1	Run/stop signal input	Contact output signal 3	Alarm status signal output	Contact output signal 2	Remote status signal output	Contact output signal 1	Operation status signal output
	Signal description	Default setting ^{*1}												
	Contact input signal 2	---												
	Contact input signal 1	Run/stop signal input												
	Contact output signal 3	Alarm status signal output												
	Contact output signal 2	Remote status signal output												
	Contact output signal 1	Operation status signal output												

*1 The pin numbers and output signals can be set by user. For details, refer to the [5.19 Communication function].
 *2 When using with optional accessories, depending on the accessory, the allowable current of 24 VDC devices will be reduced. Refer to the operation manual of the optional accessories for details.

■ Serial communication

Table 9-7 Specifications

Item	Specification	
Connector type (for this product)	D-sub9 pin Female connector(Mounting screw: M2.6x0.45)	
Protocol	Modicon Modbus standard / Simple communication protocol	
Standard	EIA RS-485	EIA RS-232C
Circuit structure diagram		

9.2 Outline dimensions

9.2.1 HRSH090-A*-20/40-*

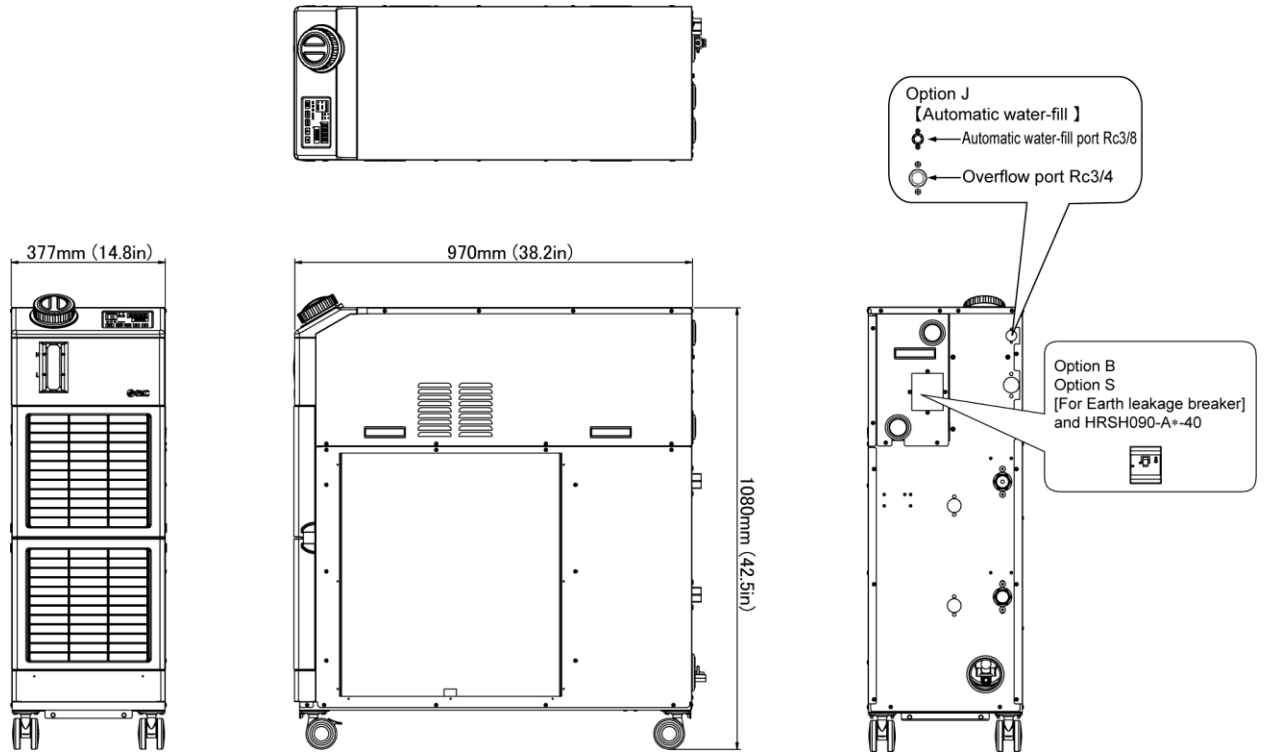
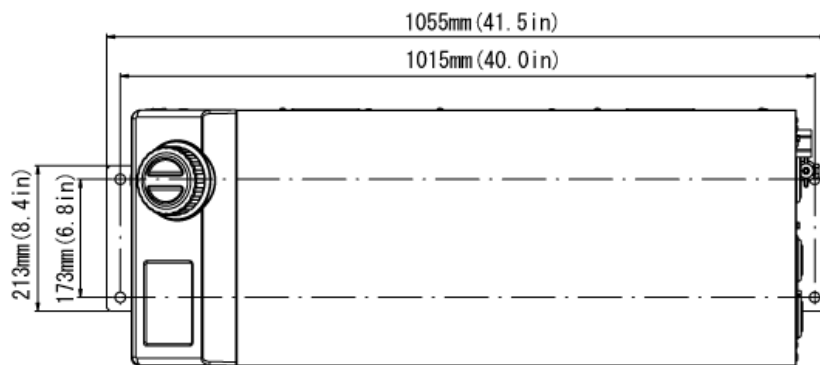

Fig. 9-1 Outline dimensions



Dimensions for the positions of the anchor bolts

9.2.2 HRSH090-W*-20/40-*

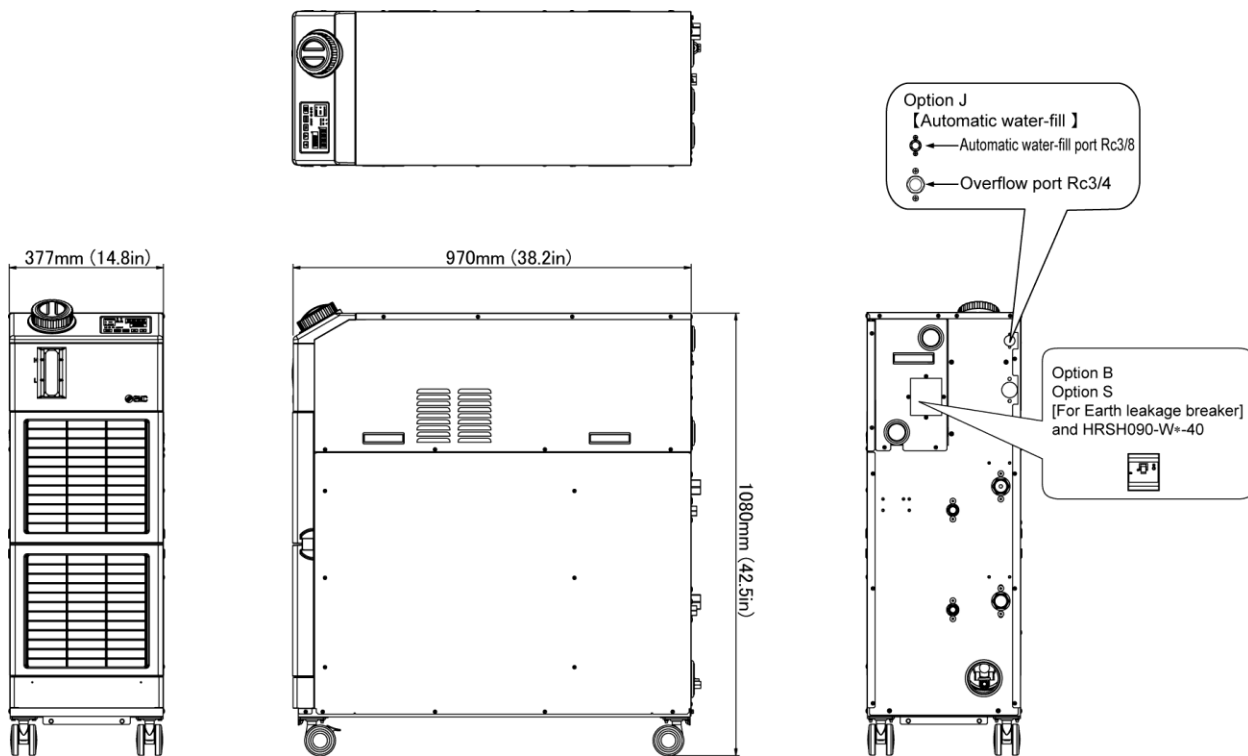
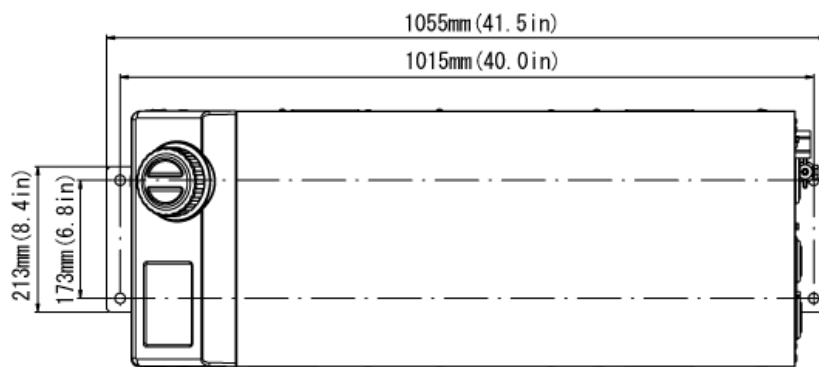

Fig. 9-2 Outline dimensions



Dimensions for the positions of the anchor bolts

9.3 Flow diagram

9.3.1 HRSH090-A*-20/40-*

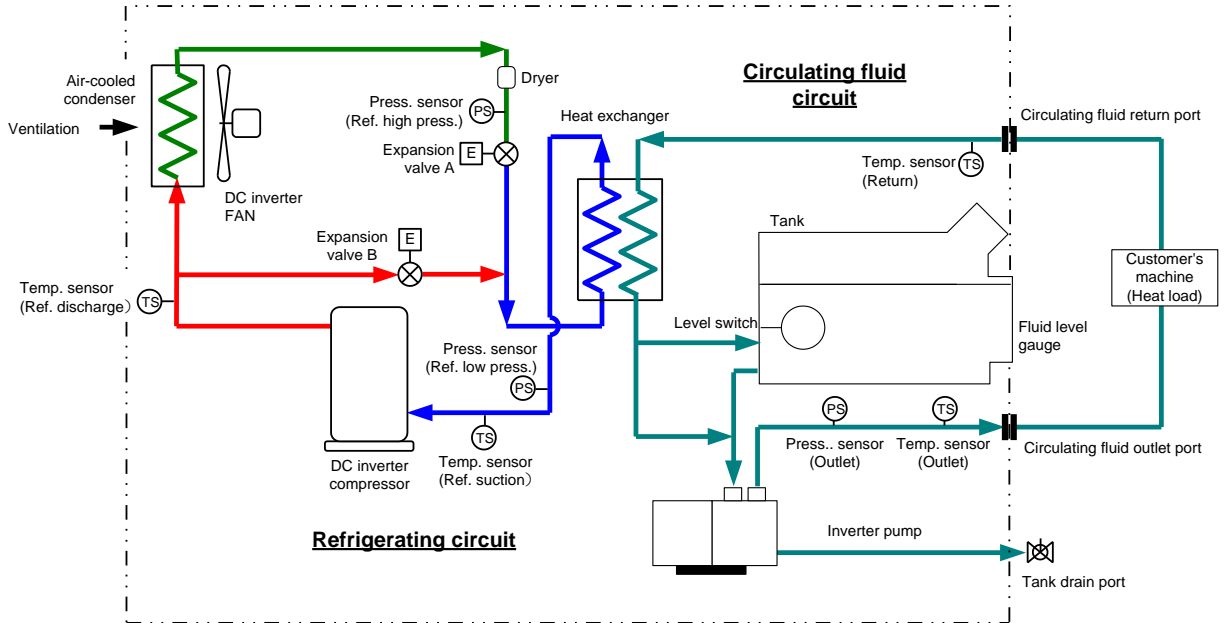

Fig. 9-3 Flow diagram(HRSH090-A*-20/40-*)

9.3.2 HRSH090-W*-20/40-*

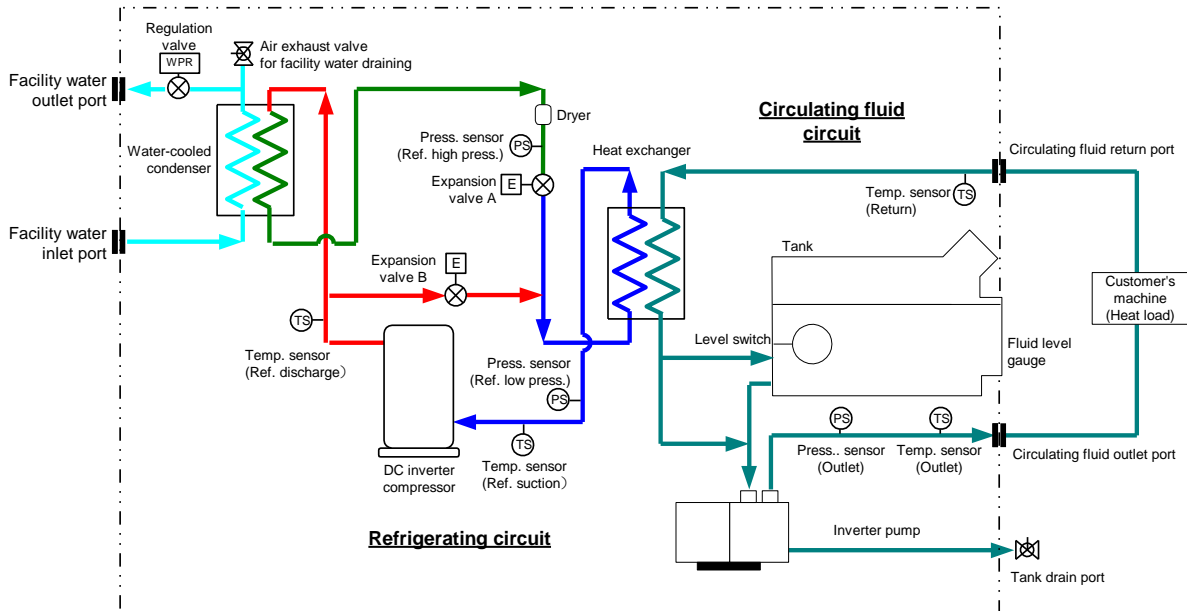

Fig. 9-4 Flow diagram(HRSH090-W*-20/40-*)

9.4 Cooling capacity

9.4.1 HRSH090-A*-20-*

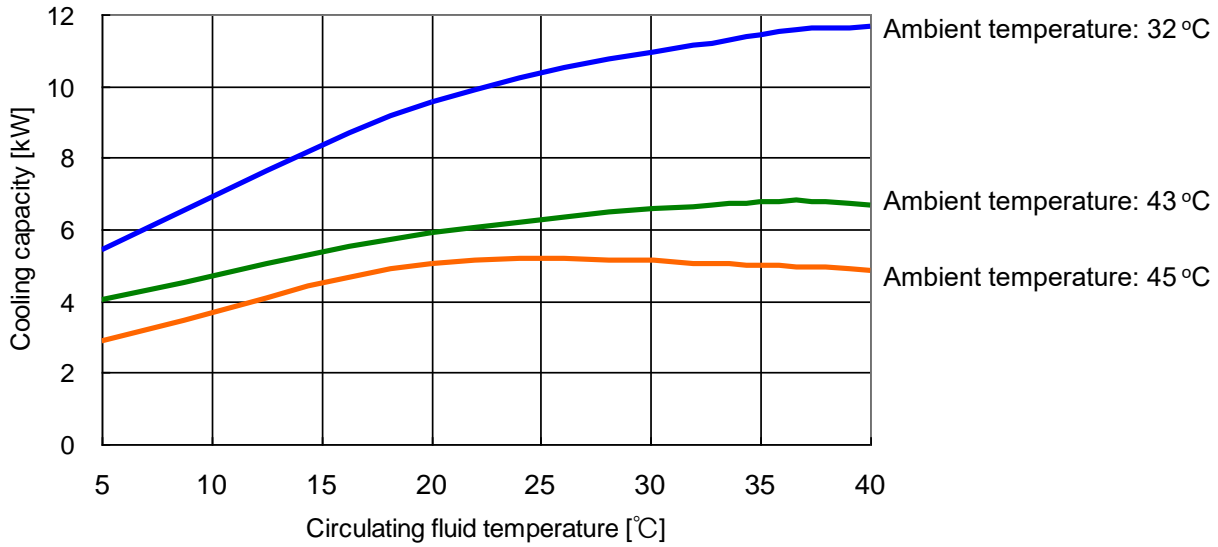

Fig. 9-5 Cooling capacity(HRSH090-A*-20-*)

9.4.2 HRSH090-A*-40-*

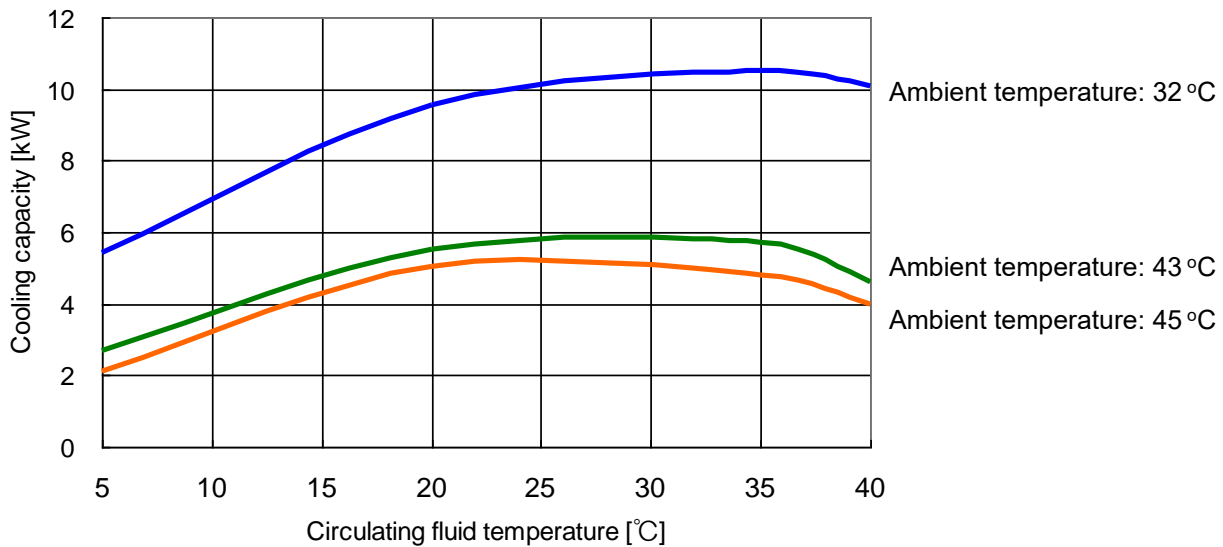

Fig. 9-6 Cooling capacity(HRSH090-A*-40-*)

9.4.3 HRSH090-W*-20-*、HRSH090-W*-40-*

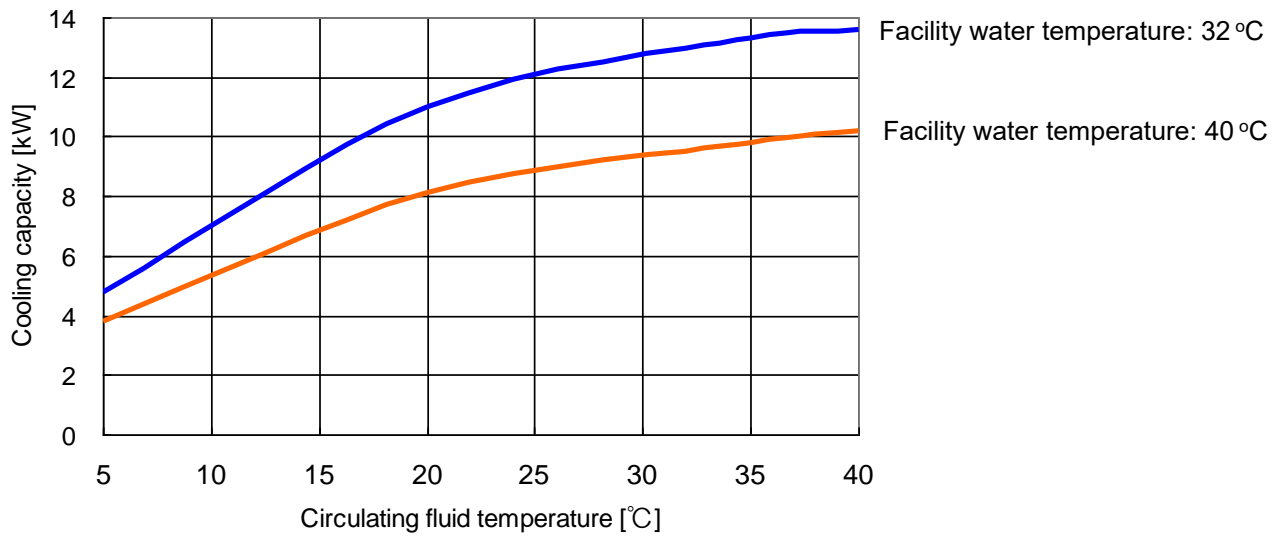

Fig. 9-7 Cooling capacity(HRSH090-W*-20-*、HRSH090-W*-40-*)

Pump capacity

9.4.4 HRS090-A*-20/40-*, HRS090-W*-20/40-*

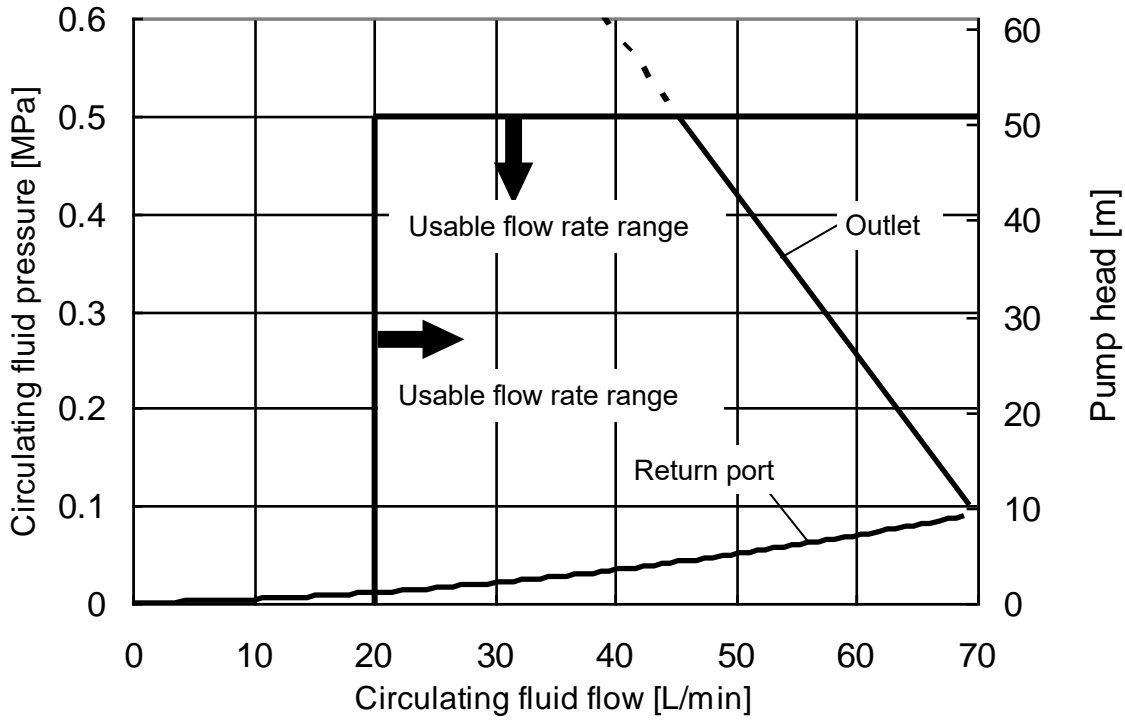



Fig. 9-8 Pump capacity (HRS090-A*-20/40-*, HRS090-W*-20/40-*)

9.5 Types of hazard labels



(For HRSH090-**-20-S, HRSH090-**-40-*)

The product has various potential hazards and they are marked with warning labels. Be sure to read this section before starting any work on the product.



■ Warning related to electricity

 WARNING	
	<p>This symbol stands for a possible risk of electric shock.</p> <p>The product is operated at high voltage and contains uncovered live terminals inside.</p> <ul style="list-style-type: none">● DO NOT operate the product without cover panels fitted.● DO NOT work inside this product unless you have been trained to do so.

■ Warning related to high temperatures

 WARNING	
	<p>This symbol stands for a possible risk of hot surface and burns.</p> <p>The product has surfaces that can reach high temperatures during operation. Even after the power is turned off, there can still be residual heat in the product.</p> <ul style="list-style-type: none">● DO NOT operate the product without cover panels fitted.● DO NOT start working inside the product until the temperature has decreased sufficiently.

■ Warning related to rotating objects (Air cooled type only)

 WARNING	
	<p>This symbol stands for a possible risk of cutting fingers or hand, or entanglement by rotating fan (For air-cooled type).</p> <p>The product contains a cooling fan that rotates during operation of the product.</p> <p>The fan can start and stop intermittently and without warning.</p> <ul style="list-style-type: none">● DO NOT operate the product without cover panels fitted.

9.5.1 Locations of Hazard Labels

There are various warning labels on the product to show the potential hazards.

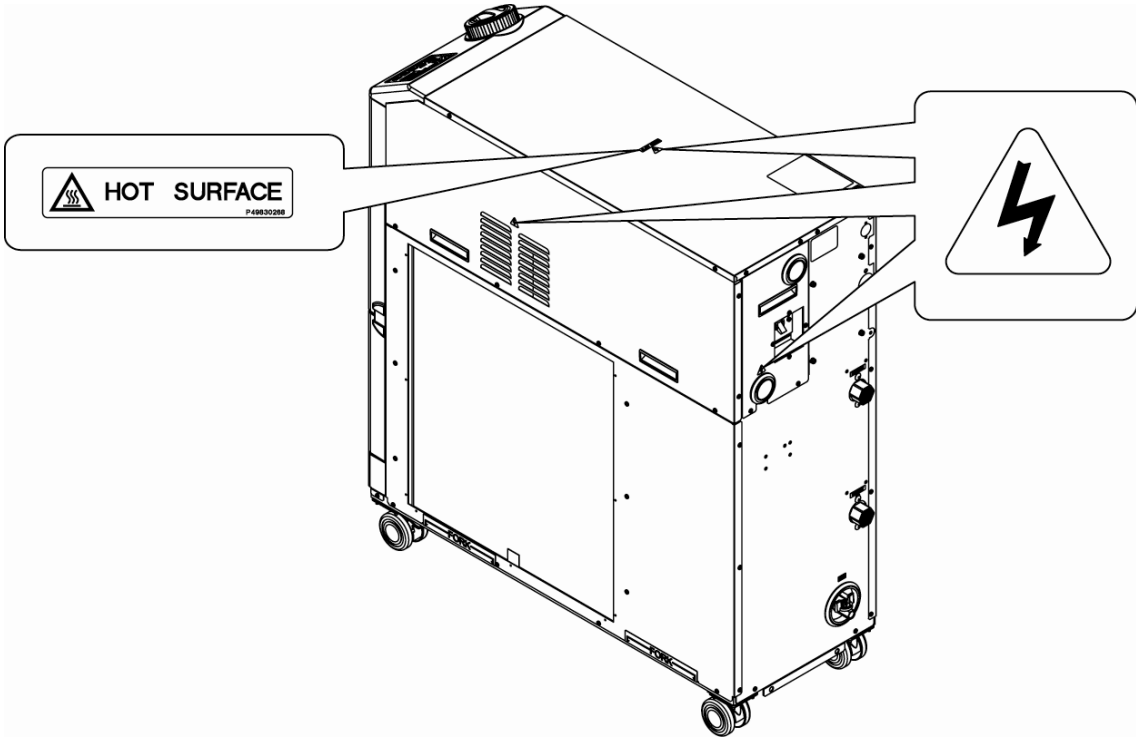

Fig. 9-9 Locations of Hazard Labels

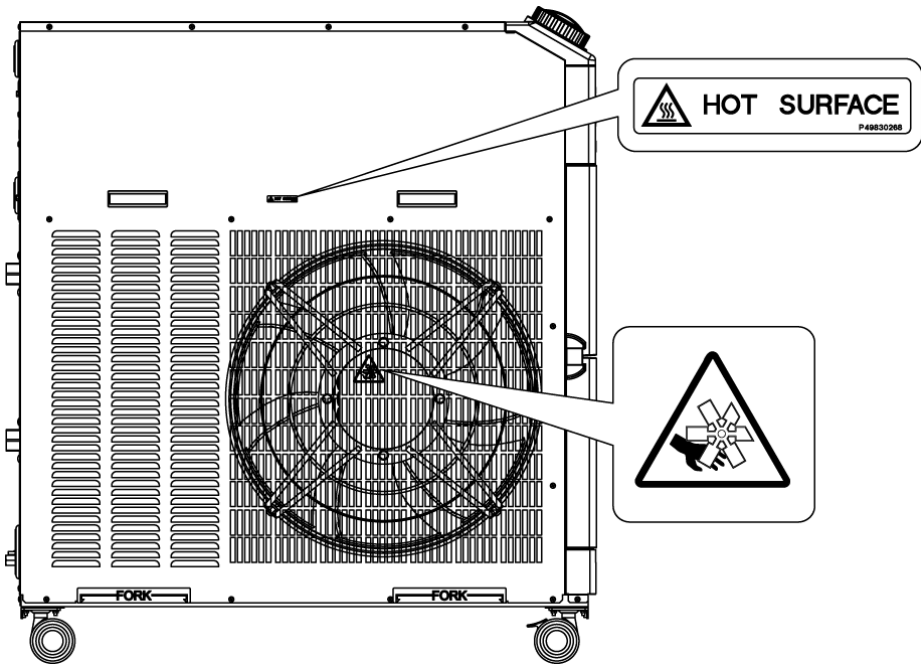

Fig. 9-10 Locations of Hazard Labels

9.6 Compliance standard

This system conforms to the following standards.

Table 9-2 Compliance standard

Standard		Model
CE Mark	EMC Directive	2004/108/EC
	Machinery Directive	2006/42/EC
UL/CSA standard (NRTL certified)	UL61010-1 3 rd edition	HRSH090-**-20-S
	CSA C22.2 No.61010-1 3 rd edition	

9.7 Sample DoC.



Sample DoC.

EC DECLARATION OF CONFORMITY

Original declaration

SMC Corporation
4-14-1 Soto-Kanda, Chiyoda-ku, Tokyo 101-0021 Japan

declares under our sole responsibility that the following equipment:

Thermo Chiller
HRS Series
Serial No.: *o001 to *Z999

conforms with the following directive(s) and harmonized standards:

Directive	Harmonized standards
Machinery Directive 2006/42/EC	EN ISO12100:2010 EN60204-1:2006+A1:2009
EMC Directive 2004/108/EC	EN61000-6-2:2005 EN55011:2009+A1:2010

Name and address of the person authorised to compile the technical file:

Mr. G. Berakoetxea, Director & General Manager, SMC European Zone,
 SMC España, S.A.,Zuazobidea 14, 01015 Vitoria, Spain

Importer/Distributor in EU and EFTA:

Country	Company	Telephone	Address
Austria	SMC Pneumatik GmbH (Austria)	(43) 2262-62280-0	Girakstrasse 8, AT-2100 Korneuburg
Belgium	SMC Pneumatics N.V./S.A.	(32) 3-355-1464	Nijverheidsstraat 20, B-2160 Wommelgem
Bulgaria	SMC Industrial Automation Bulgaria EOOD	(359) 2 9744492	Business Park Sofia, Building 8-6th Floor, BG-1715 Sofia
Czech Republic	SMC Industrial Automation CZ s.r.o.	(420) 541-426-611	Hudcova 78a CZ-61200 Brno
Denmark	SMC Pneumatik A/S	(45) 70 25 29 00	Egeskovvej 1, DK-8700 Horsens
Estonia	SMC Pneumatics Estonia OÜ	(372)651-0370	Laki 12, EE-10621 Tallinn
Finland	SMC Pneumatikka Finland Oy	(358) 20 7513 513	PL72, Tiistinniityntie 4, SF-02231 Espoo
France	SMC Pneumatique S.A.	(33) 1-6476-1000	1 Boulevard de Strasbourg, Parc Gustave Eiffel, Bussy Saint Georges, F-77600
Germany	SMC Pneumatik GmbH	(49) 6103-402-0	Boschring 13-15, D-63329 Egelsbach
Greece	SMC Hellas E.P.E	(30) 210-2717265	Anagenniseos 7-9 - P.C. 14342, Nea Philadelphia, Athens
Hungary	SMC Hungary Ipari Automatizálási Kft.	(36) 23-511-390	Torbágy u. 19, HU-2045 Törökbálint
Ireland	SMC Pneumatics (Ireland) Ltd.	(353) 1-403-9000	2002 Citywest Business Campus, Naas Road, Saggart, Co. Dublin
Italy	SMC Italia S.p.A.	(39) 02-9271-1	Via Garibaldi, 62, I-20061 Carugate, Milano
Latvia	SMC Pneumatics Latvia SIA	(371)781-77-00	Šmerla ielā, 1-705, Rīga LV-1006
Lithuania	SMC Pneumatics Lietuva,UAB	(370)5-264-81-26	Oslo g.1, LT-04123 Vilnius
Netherlands	SMC Pneumatics B.V.	(31) 20-531-8888	De Ruyterkade 120, NL-1011 AB Amsterdam
Norway	SMC Pneumatics Norway AS	(47) 67-12-90-20	Vollsveien 13c, Granfoss Næringspark, N-1366 Lysaker
Poland	SMC Industrial Automation Polska Sp. zo.o	(48) 22 211 96 00	ul. Poloneza 89, PL-02-826 Warszawa
Portugal	SMC Sucursal Portugal, S.A.	(351) 22 616 6570	Rua De Eng Ferrerira Dias 452 4100-246,Porto
Romania	SMC Romania S.r.l.	(40)21-3205111	Str. Frunzei, Nr.29, Sector 2 Bucharest, Romania
Slovakia	SMC Priemyselna Automatizacia, s.r.o.	(421) 2-444 56 725	Námestie Matina Benku, 10, 81107 Bratislava
Slovenia	SMC Industrijska Avtomatika d.o.o.	(386) 7388 5412	Mirnska cesta 7, SLO-8210 Trebnje
Spain	SMC España, S.A.	(34) 945-184-100	Zuazobidea 14, 01015 Vitoria
Sweden	SMC Pneumatics Sweden AB	(46) 8-603-12-00	Ekhagsvägen 29-31, SE-14171 Segeltorp
Switzerland	SMC Pneumatik AG	(41) 52-396-3131	Dorfstrasse 7, Postfach 117 CH-8484, Weisslingen
United Kingdom	SMC Pneumatics (U.K.) Ltd.	(44) 1908-563888	Vincent Avenue, Crownhill, Milton Keynes, Bucks MK8 0AN

Tokyo, *th January 20**

Iwao Mogi
 Director & General Manager
 Product Development Division - VI

SMC Thermo-chiller Daily Check Sheet

Model no. _____
 Mfg. code _____

For information about how to perform daily checks of the thermo chiller, refer to section “8.2.1 Daily Check” of the operation manual.
 Check and record the condition at start right after setting up.

Date	Performed by	Setting up conditions		Fluid leakage		Fluid amount		Operation panel		Circulating fluid circuit			Facility, <small>main system</small> (Water-cooled only)			Operation conditions		Result
		Temperature °C	Humidity %	Present/ Not present	Inside/Outside of liquid level indicator range	Display	Operation	Temperature °C	Flow rate L/min	Discharge press. MPa	Supply temp. °C	Flow rate L/min	Supply press. MPa	outlet press. MPa	Presence of error	Present/Not present		
Initial value (Default setting)																		

Chapter 10 Product Warranty

1. Period

The warranty period of the product is 1 year in service or 1.5 years after the product is delivered whichever comes first.

2. Scope

For any failure reported within the warranty period which is clearly our responsibility, replacement parts will be provided. In that case, removed parts shall become the property of SMC. This guarantee applies only to our product independently, and not to any other damage incurred due to the failure of the product.

3. Content

1. We guarantee that the product will operate normally if it is installed under maintenance and control in accordance with the Operation Manual, and operated under the conditions specified in the catalog or contracted separately.
2. We guarantee that the product does not have any defects in components, materials or assembly.
3. We guarantee that the product complies with the outline dimensions provided.
4. The following situations are out of scope of this warranty.
 - (1) The product was incorrectly installed or connected with other equipment.
 - (2) The product was under insufficient maintenance and control or incorrectly handled.
 - (3) The product was operated outside of the specifications.
 - (4) The product was modified or altered in construction.
 - (5) The failure was a secondary failure of the product caused by the failure of equipment connected to the product.
 - (6) The failure was caused by a natural disaster such as an earthquake, typhoon, or flood, or by an accident or fire.
 - (7) The failure was caused by operation different from that shown in the Operation Manual or outside of the specifications.
 - (8) The checks and maintenance specified (daily checks and regular checks) were not performed.
 - (9) The failure was caused by the use of circulating fluid or facility water other than those specified.
 - (10) The failure occurred naturally over time (such as discoloration of a painted or plated face).
 - (11) The failure does not affect the functioning of the product (such as new sounds, noises and vibrations).
 - (12) The failure was due to the "Installation Environment" specified in the Operation Manual.
 - (13) The failure was caused by the customer disregarding "6. Request to customers".

4. Agreement

If there is any doubt about anything specified in "2. Scope" and "3. Content", it shall be resolved by agreement between the customer and SMC.

5. Disclaimer

- (1) Expenses for daily and regular checks
- (2) Expenses for repairs performed by other companies
- (3) Expenses for transfer, installation and removal of the product
- (4) Expenses for replacement of parts other than those in this product, or for the supply of liquids
- (5) Inconvenience and loss due to product failure (such as telephone bills, compensation for workplace closure, and commercial losses)
- (6) Expenses and compensation not covered in "(1) Content".

6. Request to customers

Proper use and maintenance are essential to assure safe use of this product. Be sure to satisfy the following preconditions. Please note that we may refuse to carry out warranted repair if these preconditions have been disregarded.

- (1) Use the product following the instructions for handling described in the Operation Manual.
- (2) Perform checks and maintenance (daily checks and regular checks) specified in the Operation Manual and Maintenance Manual.
- (3) Record the check and maintenance results on the daily check sheet attached to the Operation Manual and Maintenance Manual.

7. Request for Warranted Repair

For warranted repair, please contact the supplier you purchased this product from.

Warranted repair shall be on a request basis.

Repair shall be provided free of charge in accordance with the warranty period, preconditions and terms defined above. Therefore, a fee will be charged for any repairs if a failure is detected after the end of the warranty period.

Revision
Rev R : Dec.2022

SMC Corporation

4-14-1, Sotokanda, Chiyoda-ku, Tokyo 101-0021 JAPAN

Tel: + 81 3 5207 8249 Fax: +81 3 5298 5362

URL <https://www.smcworld.com>

Note: Specifications are subject to change without prior notice and any obligation on the part of the manufacturer.
© 2022 SMC Corporation All Rights Reserved