



Operation Manual

Installation · Operation

Original Instructions

Thermo chiller

Air-Cooled refrigerated type

HRSE012/018/024 Series

[HRSE012/018/024-A-23(-T) **CE**]

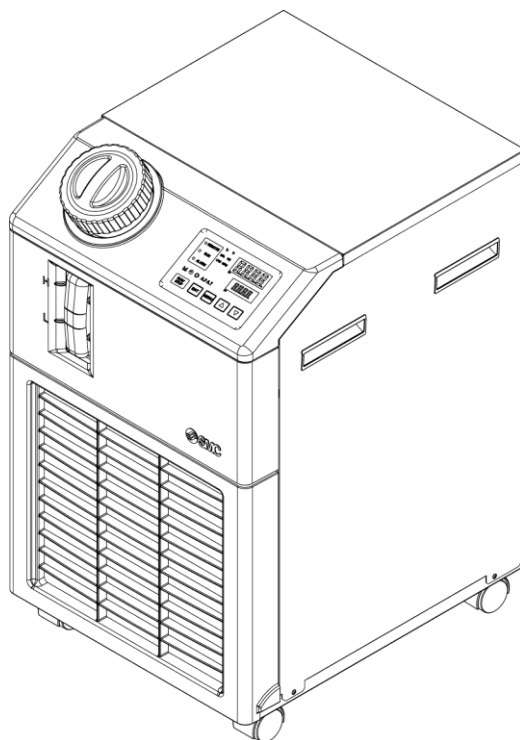

Keep this manual available whenever necessary

To the users

Thank you for purchasing SMC's Thermo chiller (hereinafter referred to as the "product").

For safety and long life of the product, be sure to read this operation manual (hereinafter referred to as the "manual") and clearly understand the contents.

- Be sure to read and follow all instructions noted with "Warning" or "Caution" in this manual.
- This manual is intended to explain the installation and operation of the product. Only people who understand the basic operation of the product through this manual or who perform installation and operation of or have basic knowledge about industrial machines are allowed to work on the product.
- This manual and other documents attached to the product do not constitute a contract, and will not affect any existing agreements or commitments.
- It is strictly prohibited to copy this manual entirely or partially for the use by a third party without prior permission from SMC.

Note: This manual is subject to possible change without prior notice.

Contents

Chapter 1	Safety Instructions	1-1
1.1	Before using the product	1-1
1.2	Reading the Manual	1-1
1.3	Hazards	1-2
1.3.1	Level of hazards	1-2
1.3.2	Definition of "Serious injury" and "Minor injury"	1-2
1.3.3	Types of hazard labels	1-3
1.3.4	Locations of Hazard Labels	1-4
1.4	Other Labels	1-5
1.4.1	Product Label	1-5
1.5	Safety Measures	1-5
1.5.1	Safety Instructions for Use	1-5
1.5.2	Personal Protective Equipment	1-6
1.6	Emergency Measures	1-7
1.7	Waste disposal	1-8
1.7.1	Disposal of refrigerant and compressor oil	1-8
1.7.2	Disposal of product	1-8
1.8	Material Safety Data Sheet (MSDS)	1-8
Chapter 2	Name and Function of Parts	2-1
2.1	Part number of product	2-1
2.2	Name and Function of Parts	2-2
2.3	Function of Parts	2-3
2.4	Operation display panel	2-4
Chapter 3	Transport and Setting Up	3-1
3.1	Transport	3-1
3.1.1	Transportation using casters	3-2
3.2	Installation	3-3
3.2.1	Environment	3-3
3.2.2	Location (Required ventilation rate and facility water source)	3-4
3.2.3	Installation and Maintenance Space	3-5
3.3	Installation	3-6
3.3.1	Mounting	3-6
3.3.2	Electrical wiring	3-7
3.3.3	Preparation and wiring of power supply cable	3-8
3.4	PIPING	3-10
3.5	Fill of circulating fluid	3-12
Chapter 4	Starting the Product	4-1
4.1	Before Starting	4-1
4.2	Preparation for Start	4-2

4.2.1	Power supply	4-2
4.2.2	Setting of circulating fluid temperature	4-2
4.3	Preparation of circulating fluid	4-3
4.4	Starting and Stopping.....	4-5
4.4.1	Starting the product	4-5
4.4.2	Stopping the product.....	4-6
4.5	Check items after starting	4-7
4.6	Adjustment of Circulating Fluid.....	4-7
Chapter 5	Display and setting of various functions	5-1
5.1	Function.....	5-1
5.1.1	Key operations.....	5-1
5.1.2	Key operations.....	5-2
5.1.3	List of parameters	5-4
5.2	Main screen	5-7
5.2.1	Main screen	5-7
5.2.2	Display on the main screen	5-7
5.3	Alarm display menu	5-8
5.3.1	Alarm display menu	5-8
5.3.2	Content of display of alarm display menu.....	5-8
5.4	Inspection monitor menu	5-9
5.4.1	Inspection monitor menu	5-9
5.4.2	Checking of the Inspection monitor menu	5-9
5.5	Alarm buzzer sound setting	5-12
5.5.1	Alarm buzzer sound setting	5-12
5.5.2	Alarm buzzer sound setting and checking	5-12
5.6	Alarm customize function	5-13
5.6.1	Alarm customize function.....	5-13
5.6.2	Alarm customize function setting and checking	5-13
5.6.3	Setting of temperature alarm monitoring method and alarm generation timing	5-21
5.7	Data reset function	5-23
5.7.1	Data reset function.....	5-23
5.7.2	Method of resetting data reset function	5-23
5.8	Accumulated time reset function.....	5-24
5.8.1	Accumulated time reset function	5-24
5.8.2	Method of resetting accumulated time reset function.....	5-24
5.9	Function to recover from power failure.....	5-26
5.9.1	Function to recover from power failure	5-26
5.9.2	Function to recover from power failure setting and checking	5-27
Chapter 6	Alarm indication and trouble shooting.....	6-1
6.1	Alarm Display.....	6-1

6.2	Alarm buzzer stop	6-2
6.3	Troubleshooting	6-3
6.4	Other Errors	6-4
Chapter 7	Control, Inspection and Cleaning	7-1
7.1	Control of Circulating Fluid Quality	7-1
7.2	Inspection and Cleaning	7-2
7.2.1	Daily check	7-2
7.2.2	Monthly check	7-3
7.2.3	Inspection every 3 months	7-4
7.2.4	Inspection for winter season.....	7-4
7.3	Consumables.....	7-5
7.4	Stop for a Long Time.....	7-5
7.4.1	Discharge of the circulating fluid	7-5
Chapter 8	Documents.....	8-1
8.1	Specifications List.....	8-1
8.1.1	Product specification	8-1
8.1.2	Refrigerant with GWP reference	8-4
8.2	Outline dimensions	8-5
8.3	Flow chart	8-6
8.4	Cooling capacity.....	8-7
8.4.1	HRSE012-A-10-(T).....	8-7
8.4.2	HRSE018-A-10-(T).....	8-7
8.4.3	HRSE012-A-20/23-(T).....	8-7
8.4.4	HRSE018-A-20/23-(T).....	8-8
8.4.5	HRSE024-A-20/23-(T).....	8-8
8.5	Pump capacity	8-9
8.5.1	HRSE012/018-A-10.....	8-9
8.5.2	HRSE012/018/024-A-20/23	8-9
8.5.3	OPTION-T (HRSE012/018-A-10-T).....	8-10
8.5.4	OPTION-T (HRSE012/018/024-A-20/23-T)	8-10
8.6	Sample DoC. (Power supply “-23” only)	8-11
8.7	Daily Check Sheet	8-12
Chapter 9	Product Warranty	9-1

Chapter 1 Safety Instructions



Before using the product be sure to read and understand all the important actions highlighted in this manual.

1.1 Before using the product

- This chapter is intended to specifically describe the safety related issues for handling the product. Read this before handling the product.
- The product is a cooling device using circulating fluid. SMC does not take any responsibility for any problems that may arise from using the product for other purposes.
- This product is for indoor use only and not to be used outdoors.
- This product is not designed for a clean room. It generates dust from the internal components such as pump and fan motor.
- The product is operated at high voltage and contains components which become hot and rotate. If a component needs to be replaced or repaired, contact a specialized vendor for parts and service.
- All personnel who work with or around the product should read and understand the safety related information in this manual carefully before starting work.
- The safety manager is responsible for strictly observing safety standards, but responsibility in respect to safety standards during daily work resides with each individual operator and maintenance personnel.
- **Do not use the materials that rust or corrode for the circulating fluid and facility water circuits.** Using the materials that tend to rust or corrode may cause clogs or/and leakages of the circulating fluid and facility water circuits. In case of using these kind of materials, consider and carry out some prevention against the rusting or corrosion by the customer side.
- This manual must be kept available to operators whenever necessary.

1.2 Reading the Manual

This manual contains symbols to help identify important actions when installing, operating or maintaining the product.



This sign indicates actions that must be followed.



This sign indicates prohibited actions.

1.3 Hazards

1.3.1 Level of hazards

The instructions given in this manual aim to assure the safe and correct operation of the product, and to prevent injury of operators or damage to the product. These instructions are grouped into three categories, Danger, Warning and Caution, which indicate the level of hazard, damage and also the degree of emergency. All safety critical information should be carefully observed at all times.

“DANGER”, “WARNING” and “CAUTION” signs are in order according to severity (DANGER> WARNING> CAUTION).

DANGER

“DANGER”: Hazard that **WILL** cause serious personal injury or death during operation.

WARNING

“WARNING”: Hazard that **MAY** cause serious personal injury or death during operation.

CAUTION

“CAUTION”: Hazard that **MAY** cause minor personal injury.

CAUTION

“CAUTION without exclamation symbol”: Hazard that **MAY** cause damage or failure of the product, facility, devices, ect.

1.3.2 Definition of “Serious injury” and “Minor injury”

■ “Serious injury”

This term describes injuries that result in after effects including loss of eyesight, burns, electrical shock, fracture, poisoning, etc. and requires long-term treatment or hospitalization.

■ “Minor injury”

This term describes injuries that do not need long-term treatment or hospitalization. (Others excluded from serious injury.)

1.3.3 Types of hazard labels

The product has various potential hazards and they are marked with warning labels. Be sure to read this section before starting any work on the product.

■ **Warning related to electricity**

WARNING	
	<p>This symbol stands for a possible risk of electric shock.</p> <p>The product is operated at high voltage and contains uncovered live terminals inside.</p> <ul style="list-style-type: none"> ● DO NOT operate the product without cover panels fitted. ● DO NOT work inside this product unless you have been trained to do so.

■ **Warning related to high temperatures**

WARNING	
	<p>This symbol stands for a possible risk of hot surface and burns.</p> <p>The product has surfaces that can reach high temperatures during operation. Even after the power is turned off, there can still be residual heat in the product.</p> <ul style="list-style-type: none"> ● DO NOT operate the product without cover panels fitted. ● DO NOT start working inside the product until the temperature has decreased sufficiently.

■ **Warning related to rotating objects**

WARNING	
	<p>This symbol stands for a possible risk of cutting fingers or hand, or entanglement by rotating fan (For air-cooled type).</p> <p>The product contains a cooling fan that rotates during operation of the product.</p> <p>The fan can start and stop intermittently and without warning.</p> <ul style="list-style-type: none"> ● DO NOT operate the product without cover panels fitted.

■ **Warning related to other general dangers**

WARNING	
	<p>This symbol stands for general danger.</p> <p>Hazards Inside</p> <p>Hot Surfaces Inside – See Hot Surface symbol</p> <p>Rotating Fan Inside – See Rotating Fan symbol (For air-cooled type)</p> <p>Pressurized System Inside – The product contains pressurised fluid systems.</p> <ul style="list-style-type: none"> ● DO NOT operate the product without cover panels fitted.

1.3.4 Locations of Hazard Labels

There are various warning labels on the product to show the potential hazards.

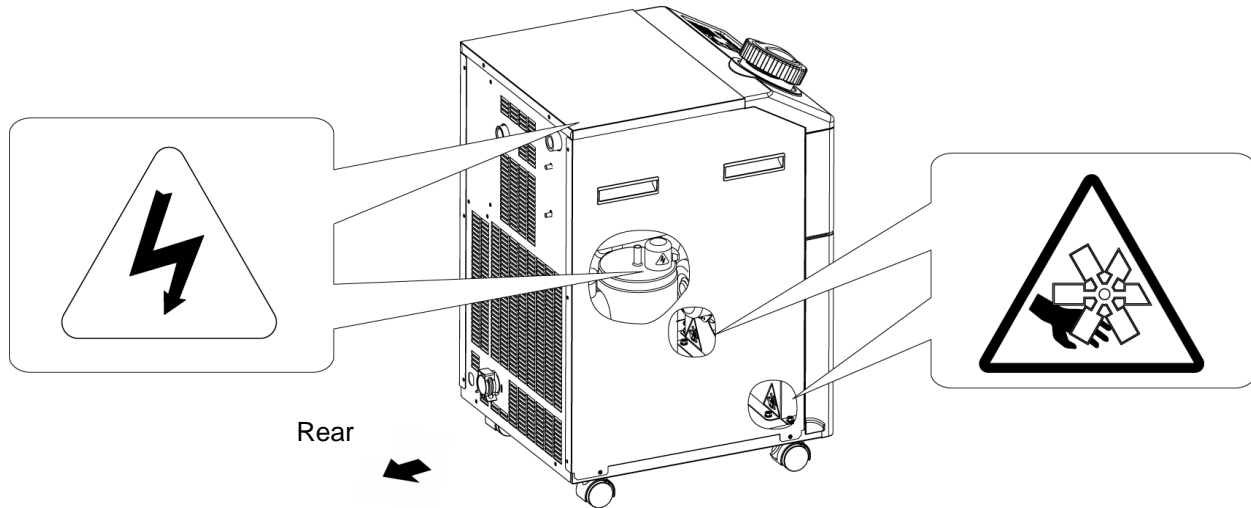

Fig. 1.3-1 Warning label position

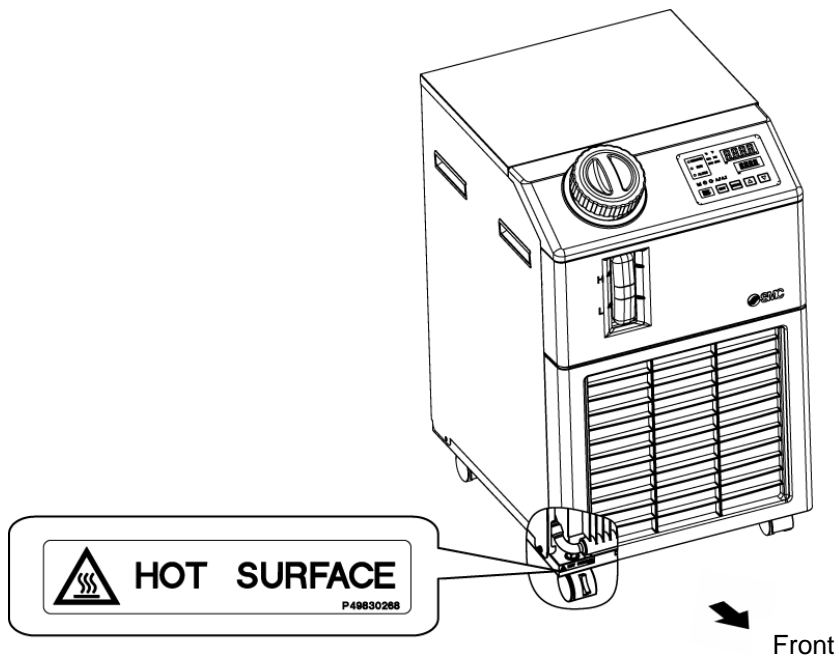
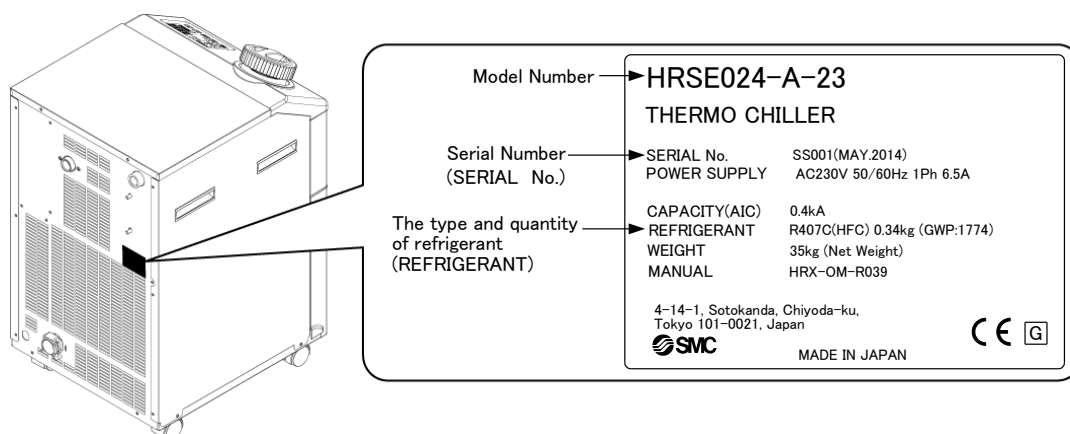

Fig. 1.3-2 Warning label position

1.4 Other Labels

1.4.1 Product Label

Information about the product, such as Serial No. and Model No. can be found on the model label. This information is needed when contacting an SMC sales distributor.



* (It is an example of model "HRSE024-A-23".)

Fig. 1.4-1 Position of product label

1.5 Safety Measures

1.5.1 Safety Instructions for Use

⚠ WARNING

Follow the instructions below when using the product. Failure to follow the instructions may cause an accident and injury.

- Read and understand this manual carefully before using the product.
- Before starting maintenance of the product, be sure to lock out and tag out the breaker of the user's power supply.
- If operating the product during maintenance, be sure to inform all workers nearby.
- Use only the correct tools and procedure when installing or maintaining the product.
- Use personal protective equipment where specified ("1.5.2 Personal Protective Equipment")
- Check all parts and screws are fitted correctly and securely after maintenance.
- Avoid working in a drunken or sick condition, which might cause an accident.
- Do not remove the panels except for the cases permitted in this manual.
- Do not remove the panels during operation.

1.5.2 Personal Protective Equipment

This manual specifies personal protective equipment for each work.

■ Transport, Installing and Uninstalling

CAUTION



Always use safety shoes, gloves and head protection when transporting, installing or uninstalling the product.

■ Handling of circulating fluid

CAUTION



Always use safety shoes, gloves, mask, apron and eye protection when handling the circulating fluid.

■ Operation

CAUTION



Always use safety shoes and gloves when operating the product.

1.6 Emergency Measures

In the event of natural disaster, emergency such as fire, earthquake, injury, etc., disconnect the power supply to this product.

⚠ WARNING



When the protective device (i.e. fuse) inside the product operates, this thermo chiller stops operation without disconnecting the power supply. Some parts of the thermo chiller are still being energized. Power supply to the thermo chiller **MUST** be disconnected from the user's equipment.

1. Disconnect power supply to the product.

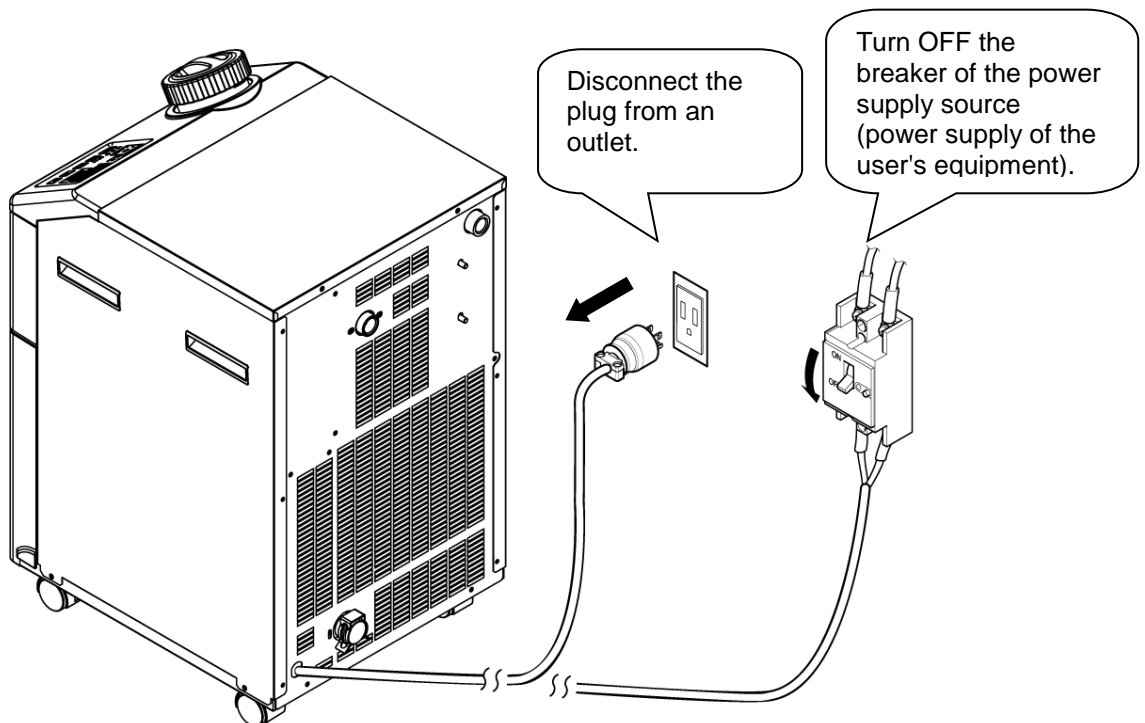

Fig. 1.6-2 Disconnect power supply

1.7 Waste disposal

1.7.1 Disposal of refrigerant and compressor oil

The product uses hydrofluorocarbon type refrigerant (HFC) and compressor oil. Comply with the laws and regulations in each country for the disposal of refrigerant and compressor oil. The type and quantity of refrigerant is described on the 1.4.1 Product Label.

If these fluids need to be recovered, read and understand the instructions below carefully. If there is any unclear point, contact an SMC's sales distributor.

WARNING



- Only maintenance personnel or qualified people are allowed to open the cover panels of the product.
- Do not mix the compressor oil with domestic waste for disposal. Also, the disposal of the waste must only be conducted by specific facilities that are permitted for that purpose.

WARNING



- Comply with the laws and regulations in each country for the disposal of refrigerant and compressor oil.
- The release of refrigerant in to the atmosphere is banned by law. Recover it with specific equipment and dispose of it correctly.
- Only people who have sufficient knowledge and experience about the product and its accessories are allowed to recover the refrigerant and compressor oil.

1.7.2 Disposal of product

The disposal of the product must be handled by a specialized industrial waste disposal agency in accordance with local laws and regulations.

1.8 Material Safety Data Sheet (MSDS)

If the material safety data sheets of chemicals used in this product are needed, contact an SMC's sales distributor.

Any chemicals used by the user must be accompanied by an MSDS.

Chapter 2 Name and Function of Parts

2.1 Part number of product

The product can be ordered with the part number configured as shown below.

Refer to "1.4.1 Product Label" and check the part number of the product.

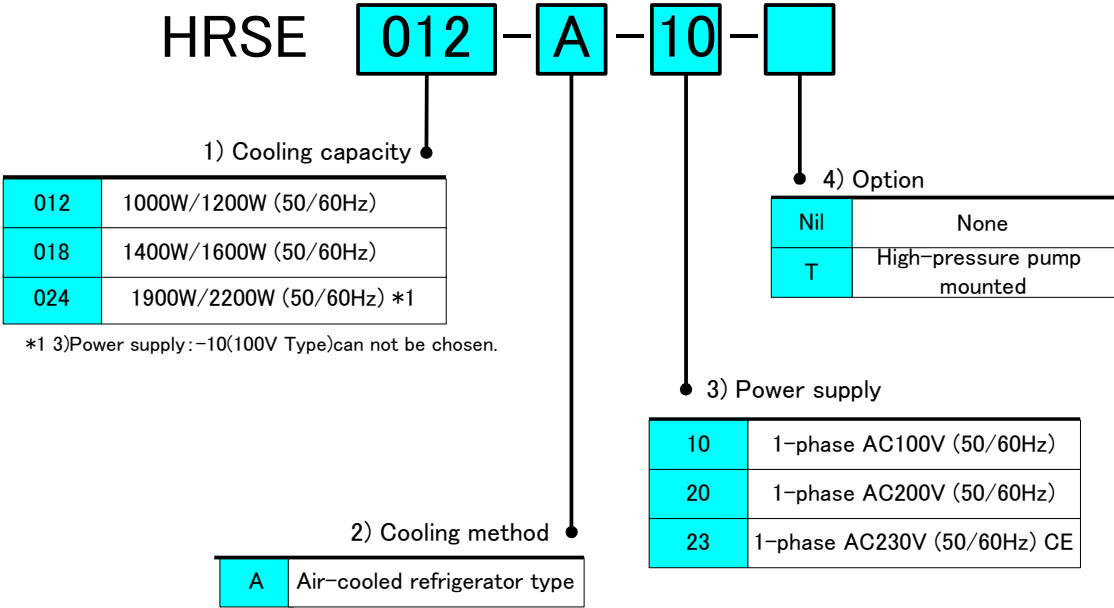

Fig. 2.1-1 Part number of product

2.2 Name and Function of Parts

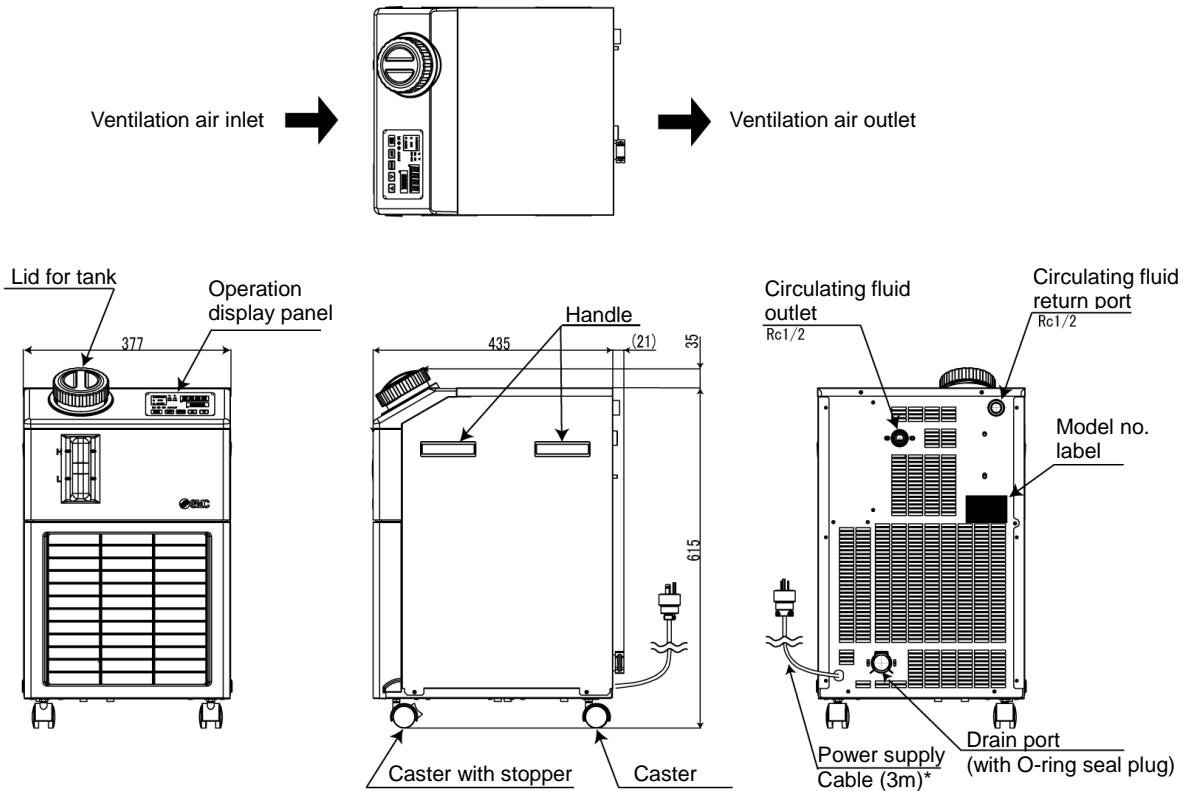

Fig. 2.2-1 Names of each part

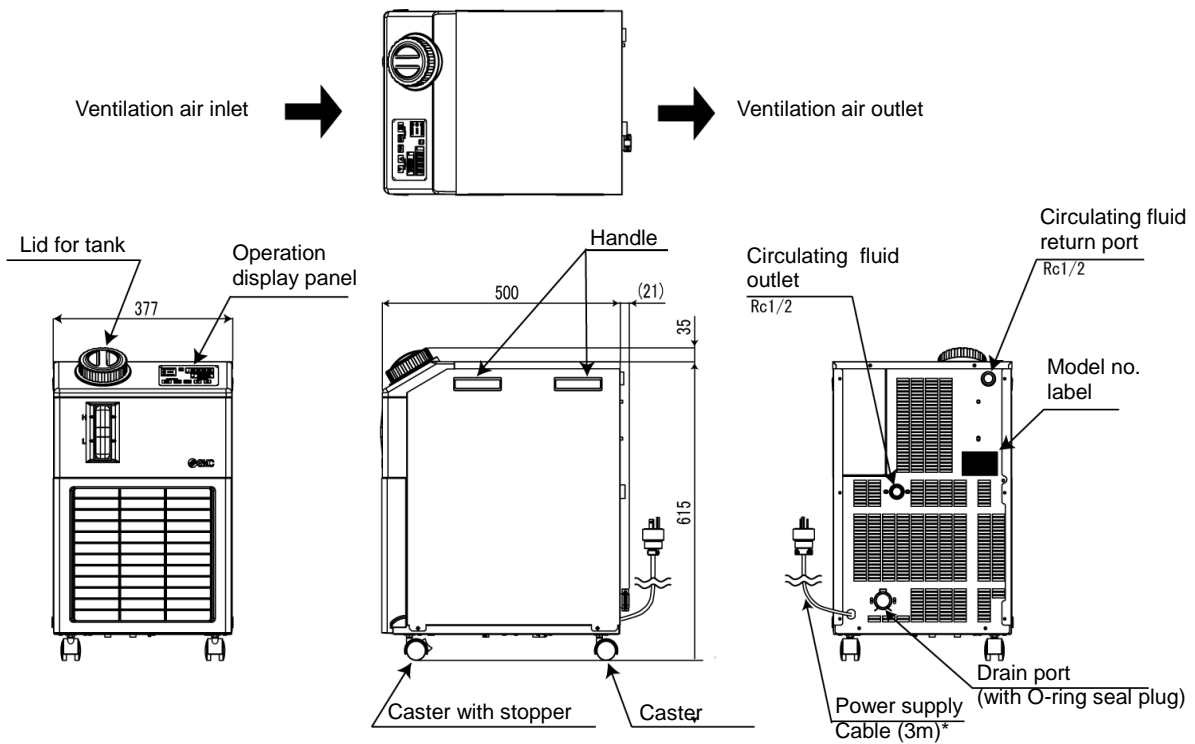



Fig. 2.2-2 Names of each part

- * Power supply cable terminal
 - 100V power supply specification: Cable is provided with a plug with ground terminal (JIS C8303 Plug for the receptacle with dipole grounding electrodes).
 - 200/230V power supply specification: The end part of all three lead wires are untreated (bare cut).

Table 2-1 Accessories list

1	Operation Manual		2pcs. (Jpn: 1pc., Eng:1pc.)
2	Fitting (for drain port)*		1pc.

2.3 Function of Parts

The function of parts is as follows.

Table 2-2 Function of parts

Name	Function
Operation display panel	Runs and stops the product and performs settings such as the circulating fluid temperature. For details, refer to section "2.4 Operation display panel".
Power supply cable	For power supply of 100 V specifications, connect the plug to the outlet of 100 VAC (50/60 Hz). For power supply of 200 V specifications, connect the plug to the breaker (recommended size: 15 A) of the user's equipment.
Model label	Shows the part number of the product. For details, refer to section "1.4.1 Product Label".
Circulating fluid outlet port	The circulating fluid flows out from the outlet port.
Circulating fluid return port	The circulating fluid returns to the return port.
Drain port	This drain port to drain the circulating fluid out of the tank. (The plug is connected to standard pump type at the time of shipment. The ball valve is installed in the high pump head type.)
Facility water inlet (For water-cooled type)	A facility water inlet to which the facility water is fed through piping. The pressure of facility water should be in a range of 0.3 to 0.5MPa.

2.4 Operation display panel

The operation panel on the front of the product controls the basic operation of the product.

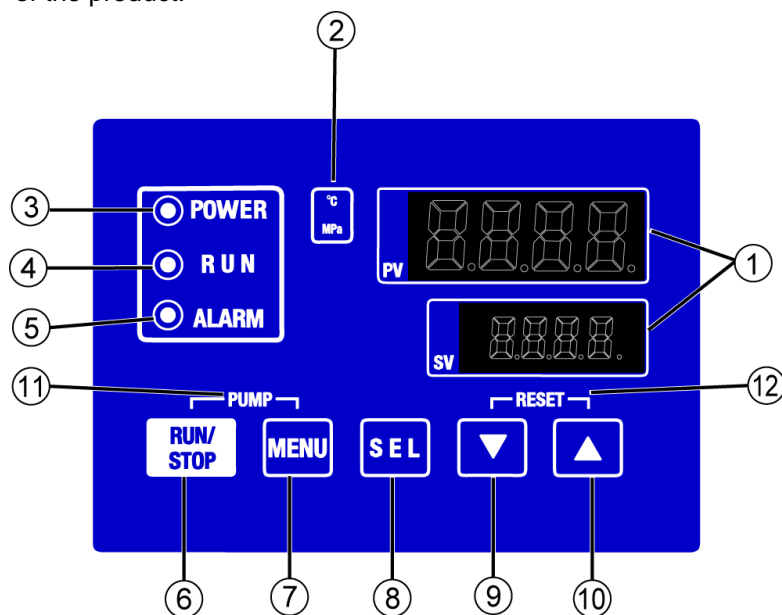

Fig. 2.4-1 Operation display panel

Table 2-3 Operation display panel

No	Description	Function	Reference page	
1	Digital display (7 segment, 4 digits)	PV	Displays the temperature and pressure of the circulating fluid and alarm codes.	5.2
		SV	Displays the set temperature of the circulating fluid and the set values of other menus.	
2	[°C] [MPa] lamp	[°C] light is turned on when temperature is displayed on the digital display. [MPa] light is turned on when pressure is displayed on the digital display.	-	
3	[POWER] lamp	Turns ON when power is being supplied.	-	
4	[RUN] lamp	<ul style="list-style-type: none"> Lights up when the product is started and in operation. Goes off when the product is stopped. Flashes during stand-by for stop (Interval 0.5 seconds). Flashes during independent operation of the pump (Interval 0.3 seconds). Flashes during anti-freezing function (At standby: Interval 2 seconds, At operation: Interval 0.3 seconds). 	4.4	
5	[ALARM] lamp	Flashes with buzzer when alarm occurs (Interval 0.3 seconds).	5.3	
6	[RUN/STOP] key	Makes the product start or stop.	4.4	
7	[MENU] key	Shifts the main menu (display screen of temperature) the other menu (entry of set values and monitor screen).	5.1	
8	[SEL] key	Changes the item in menu and enters the set value.		
9	[▼] key	Decreases the set value.	-	
10	[▲] key	Increases the set value.		
11	[PUMP] key	When the [MENU] and [RUN/STOP] keys are held down simultaneously, the pump starts running independently.	4.3	
12	[RESET] key	Keep the [▼] and [▲] keys pressed down simultaneously. This will stop the alarm buzzer and reset the [ALARM] lamp.	6.3	

Chapter 3 Transport and Setting Up

⚠ WARNING



- Only persons who have sufficient knowledge and experience about the product and system are allowed to transport and set up the product.
- Especially pay attention to personal safety.

3.1 Transport

The product is heavy and has potential danger at transport. Also, to prevent damage and breakage of the product, be sure to follow these instructions for transport.

CAUTION



- Never lay the product on its side.
- The compressor oil will leak in to the refrigerant piping, which may cause early failure of the compressor.

CAUTION



- Drain the residual fluid from the piping as much as possible to prevent any spillage.

3.1.1 Transportation using casters

⚠ WARNING



- This product is heavy.
Care should be taken when the product is transported on a slope.

1. Release the lock levers of the front casters.
2. Push the handles on the right/left panel or the corner of the product to move the product to the destination.
Do not hold the product by the cap to move it. This will apply excess force to the piping of internal parts which may lead to malfunctions such as fluid leakage.
3. To push the front or rear panel, push it by the corner. Pushing by the center of the panel may deform the shape. Care should be taken.

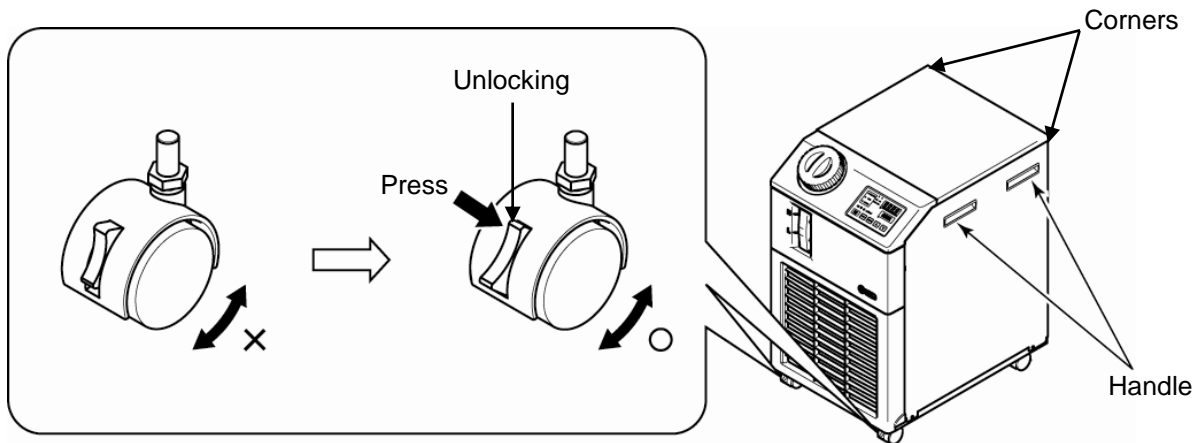



Fig. 3.1-1 Transportation using casters

3.2 Installation

⚠ WARNING	
	<ul style="list-style-type: none"> ● Do not set up the product in places possibly exposed to leakage of flammable gas. Should any flammable gas stay around the product, the product may cause a fire. ● Do not use the product outdoors. If the product subjected to rain or water splash it may cause electrical shock, fire or failure.
⚠ CAUTION	
	<ul style="list-style-type: none"> ● Keep the product horizontal to a rigid and flat floor which can resist the weight of the product, and take measures to prevent the product from tipping over. Improper installation may cause water leakage, tipping, damage of the product or injure the operator. ● Keep the ambient temperature of the product between 5 to 35°C. Operation below 5°C may cause the compressor failure, and operation above 35°C may cause the product to overheat and shut down. * Power supply 200V : The operating ambient temperature is 5 to 40°C.

3.2.1 Environment

The product must not be operated, installed, stored or transported in the following conditions. Potential malfunction or damage to the product may occur if these instructions are disregarded.

The product does not conform to any Clean room specifications. The pump and ventilating fan inside the product generate particles.

- Location that is outside.
- Location that is exposed to water, water vapour, steam, salt water or oil.
- Location that is exposed to dust or powder material.
- Location that is exposed to corrosive gas, organic solvent, chemical solution, or flammable gas (the product is not flame-proof)
- Location where the ambient temperature is out of the following range:

In transportation and In storage	0 to 50°C
(with no water or circulating fluid in piping)	
In operation	*Power supply 100V : 5 to 35°C
	*Power supply 200/230V : 5 to 40°C
- Location where the ambient humidity is out of the following range or where condensation occurs:

In transportation and storage	15 to 85%
In operation	30 to 70%
- Location that is exposed to direct sunlight or heat radiation.
- Location that is near heat sources and poor in ventilation.
- Location that is subjected to abrupt changes in temperature.
- Location that is subjected to strong electromagnetic noise (intense electric field, intense magnetic field, or surges).
- Location that is subjected to static electricity, or conditions where static electricity can discharge to the product.

- Location that is subjected to strong high frequencies radiation (microwaves).
- Location that is subjected to potential lightning strike.
- Location at altitude of 1000m or higher (except during product storage and transport).
- Location where the product is affected by strong vibrations or impacts.
- Condition that applies external force or weight causing the product to be damaged.
- Location without adequate space for maintenance as required.

3.2.2 Location (Required ventilation rate and facility water source)

CAUTION	
	<ul style="list-style-type: none"> ● Do not install in a location which can be subjected to any of the conditions in 3.2.1 Environment.

CAUTION	
	<p>The product radiates heat from the air vent of the cooling fan. If the product is operated with insufficient air ventilation the internal temperature can exceed 35°C*, which can cause an overload or affect the performance and life of the product. To prevent this ensure that suitable ventilation is available (see below).</p> <p>*Power supply 200/230V : 40°C</p>

■ **Installation of multiple products**

Keep sufficient space between products so that the air vented from one product will not be taken in by other products.

■ **Installation Area Ventilation**

- ① Facility having a large installation area (that can vent the air naturally)
Make an air vent on a wall at a high level and another air vent on a wall at a low level, to allow for adequate airflow.
- ② Facility having a small installation area (that can not vent the air naturally)
Make a forced air exhaust vent on a wall at a high level and an air vent on a wall at a low level.

Table 3-1 Amount of radiation and required ventilation

Model	Heat Radiated kW	Required ventilation amount m ³ /min	
		Differential temp. of 3 °C between inside and outside of installation area	Differential temp. of 6 °C between inside and outside of installation area
HRSE012-A*-*	Approx. 2	40	20
HRSE018-A*-*	Approx. 4	70	40
HRSE024-A*-20/23	Approx. 5	90	50

3.2.3 Installation and Maintenance Space

It is recommended to keep the space around the product shown in Fig.3.2-1

For maintenance, move the thermo-chiller into a space where maintenance work is possible.

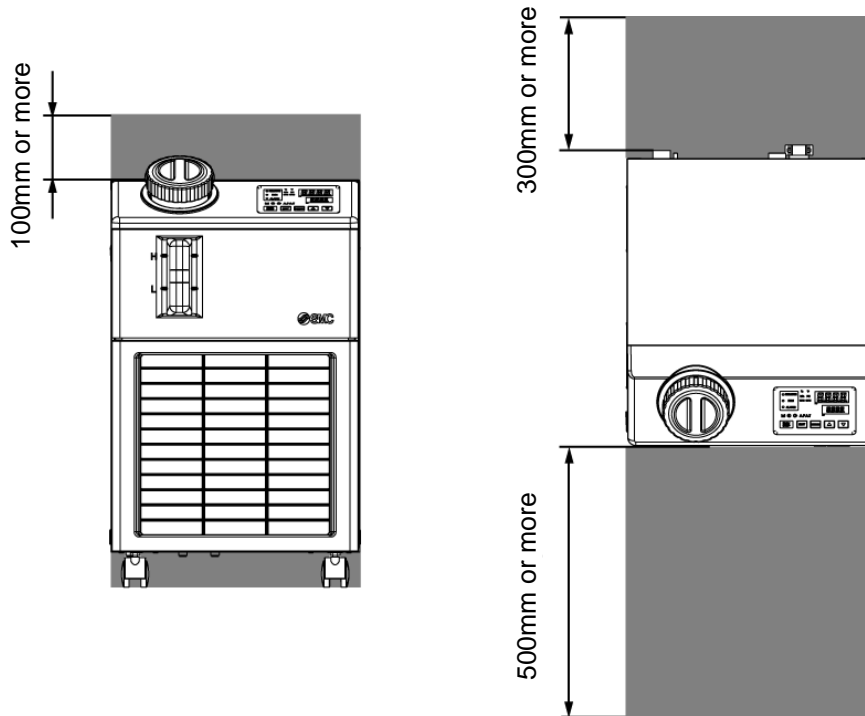

Fig. 3.2-1 Installation space

CAUTION



The temperature of the outlet of for the ventilation of the thermo-chiller and the panel surface may become approx. 50°C or higher. When placing the thermo-chiller, ensure the thermo-chiller does not affect surrounding environment.

3.3 Installation

3.3.1 Mounting

- Mount the product on a flat and stable floor with no vibrations.
- Refer to "8.2 Outline dimensions" for dimensional information of the product.

■ **How to mount the product**

1. Move the product to the installation area.

2. After moving, lock the front casters again.

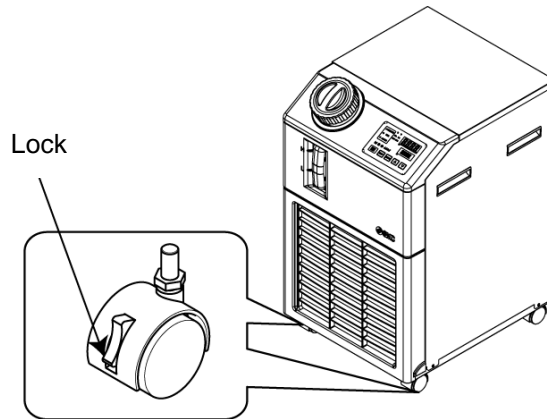

Fig. 3.3-1 Installation procedures

■ **<Fixture>**

Follow the procedure below when fixing the thermo-chiller to the floor or the mounting frame.

1. Prepare the fixing bracket shown below (Not included in the package).

Item	Part number
Anti-seismic brackets	HRS-TK003

2. Use M8 foundation bolts to fix the product within the dimensions below.

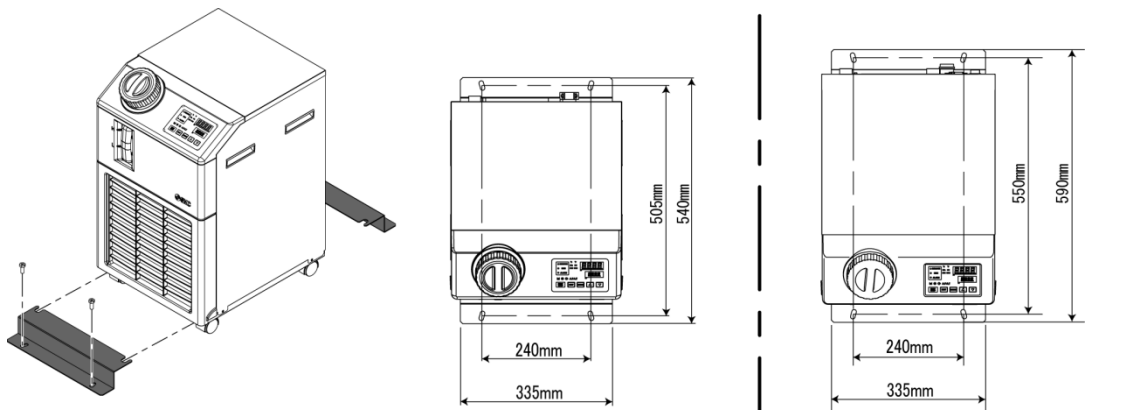



Fig. 3.3-2 Anti-seismic brackets installing

*4 (four) M8 foundation bolts should be prepared by the customer.

For option T [High head pump]

3.3.2 Electrical wiring

⚠ WARNING



- Do not modify the internal electrical wiring of the product. Incorrect wiring may cause electrical shock or fire. Also, modifying the internal wiring will void the product's warranty.
- Do not connect the ground to water line, gas pipe or lightning conductor.

⚠ WARNING



- Only qualified persons are allowed to wire the product.
- Be sure to shut off the user's power supply. Wiring with the product energized is strictly prohibited.
- The wiring must be secured to the product to prevent the external force of cables being applied to the terminals. Incomplete wiring or improper securing of wiring may cause electrical shock, excessive heat and fire.
- Ensure a stable power supply with no voltage surges.
- Ensure that an Earth Leakage Breaker is used in the power supply of the product. See "Table 3-2".
- Use a power supply suitable for the specifications of the product.
- Be sure to connect the ground connection.
- Ensure that a lock out facility is available on the power supply.
- Each product must have its own separate Earth Leakage Breaker. Otherwise there can be a risk of electric shock or fire.

■ Power supply cable and Earth Leakage Breaker

Prepare the power supply shown in the following table. For the connection between the product and power supply, use the power supply cable and earth leakage breaker shown below.

Table 3-2 Power supply cable and Earth Leakage Breaker (Recommended)

Model	Power supply voltage	Power supply cable spec			Recommended earth leakage breaker		
	Spec.	Size	Rated current	Terminal configuration (to be connected to the user's equipment)	Rated voltage	Rated current	Sensitivity of leak current
HRSE012-A-10	1-phase 100V AC (50/60Hz)	3 cores x 14AWG (3 cores x 2.0mm ²) (including ground)	15A	Plug with ground terminal (JIS C8303 Plug for the eceptacle for 15A and 125 V with dipole grounding electrodes)	Shared with 100 V and 200 V	15A	15mA or 30mA
HRSE012-A-10-T							
HRSE018-A-10							
HRSE018-A-10-T							
HRSE012-A-20/23	1-phase 200V AC (50/60Hz)	3 cores x 2.5mm ² (including ground)	15A	Lead wire end not treated (Bare cut) (L: Brown, N: Blue, PE:Green/Yellow)	Shared with 100 V, 200 V and 230V	15A	30mA
HRSE012-A-20/23-T							
HRSE018-A-20/23							
HRSE018-A-20/23-T							
HRSE024-A-20/23							
HRSE024-A-20/23-T							

3.3.3 Preparation and wiring of power supply cable

⚠ WARNING



- The electrical facilities should be installed and wired in accordance with local laws and regulations of each country and by a person who has knowledge and experience.
- Check the power supply. Operation with voltages, capacities and frequencies other than the specified values can cause fire and electrical shock.
- Wire with an applicable cable size and terminal. Forcibly mounting with an unsuitable size cable may result in heat generation or fire

■ Preparation [For power supply : 200/230V]

1. Strip the sheath from the cable of the product.

2. Connect the other end of the cable to a terminal (e.g. crimped terminal) that is compatible to the secondary side of the earth leakage breaker of the user's equipment.

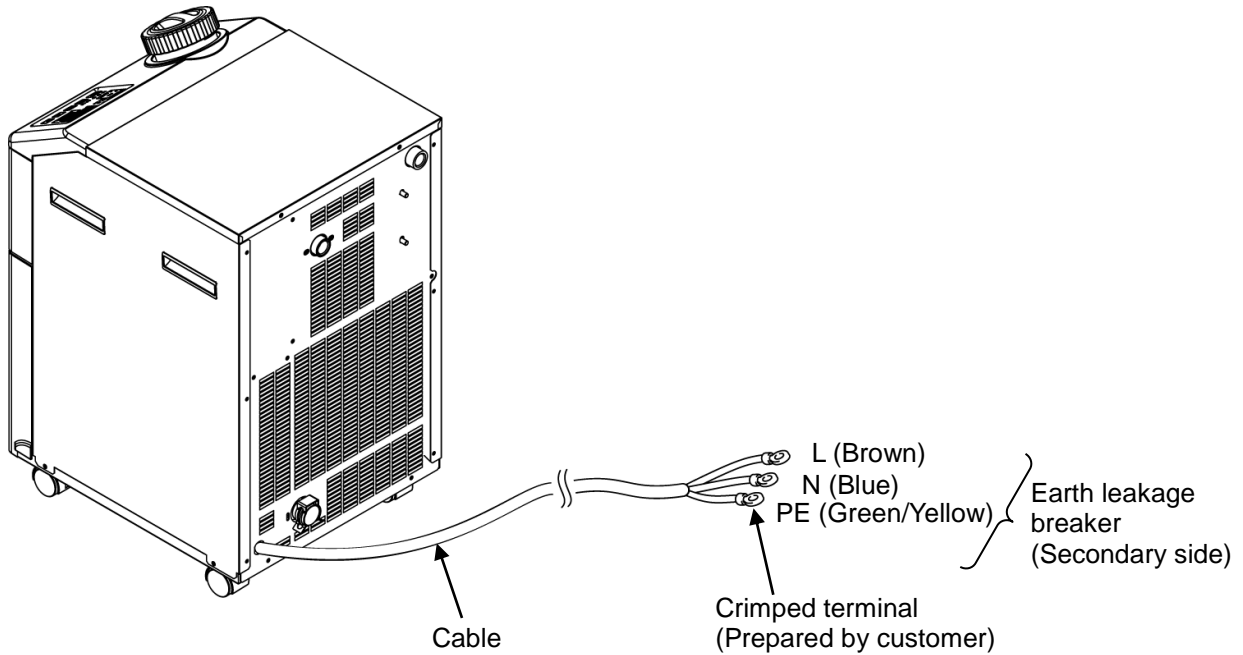

Fig. 3.3-3 Power supply cable

■ Connecting [For power supply : 100V, 200V and 230V]

1. Connect the plug or crimped terminal to the outlet with ground or to the secondary side of the electrical leakage breaker and to the grounding.
2. Plug the power supply cable in to the power cable connector on the product.

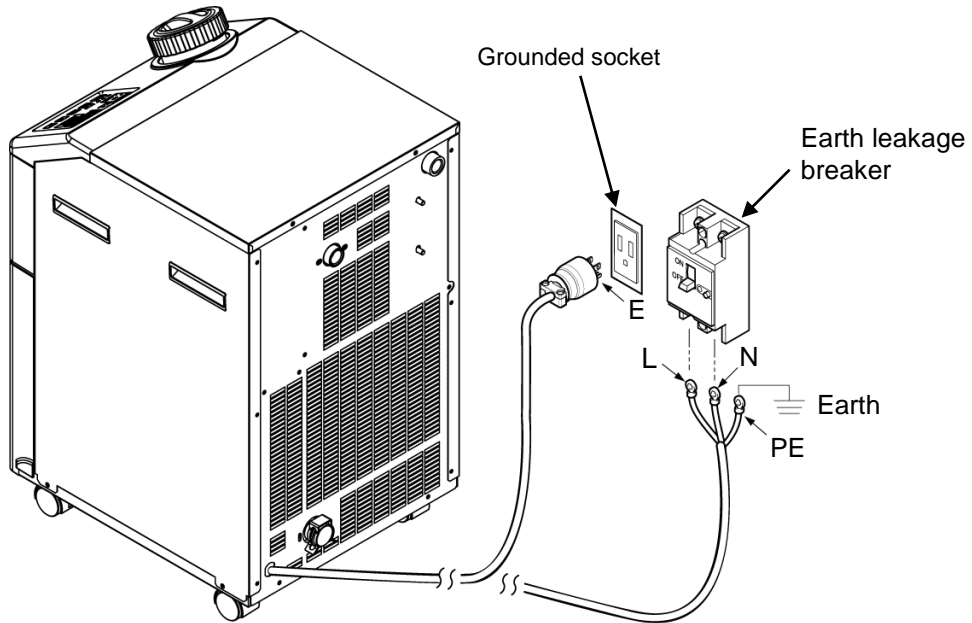



Fig. 3.3-4 Wiring of power supply

3.4 PIPING

CAUTION



- Connect piping firmly. Incorrect piping might cause leakage of supplied or drained leakage and wet surrounding area and facility.
- Pay attention not to allow dust and foreign materials to enter into water circuit etc. during connection of piping.
- Hold the piping port firmly with specific wrench when tightening.
- The piping should be selected with due consideration of pressure and temperature. Otherwise, the piping can burst in service.
- Use non-corrosive material for fluid contact parts of circulating fluid and/or facility water. Also, the use of corrosive materials such as aluminum or iron for fluid contact parts, such as piping, may not only lead to clogging or leakage in the circulating fluid and facility water circuits but also refrigerant leakage and other unexpected problems. Provide protection against corrosion when you use the product.
- Do not generate a rapid change of pressure by water hammer etc. The product and external piping might be damaged.

■ Piping port size

Table 3-3 Piping port size

Name	Port size*1	Recommended tightening torque	Recommended proof pressure for piping
Circulating fluid supply	Rc1/2	28 to 30N·m	0.3MPa more (For option T [High head pump] : 0.4MPa more)
Circulating fluid return	Rc1/2	28 to 30N·m	0.3MPa more (For option T [High head pump] : 0.4MPa more)

■ How to connect piping

Tighten the piping to circulating fluid outlet / return port and facility water outlet / inlet.

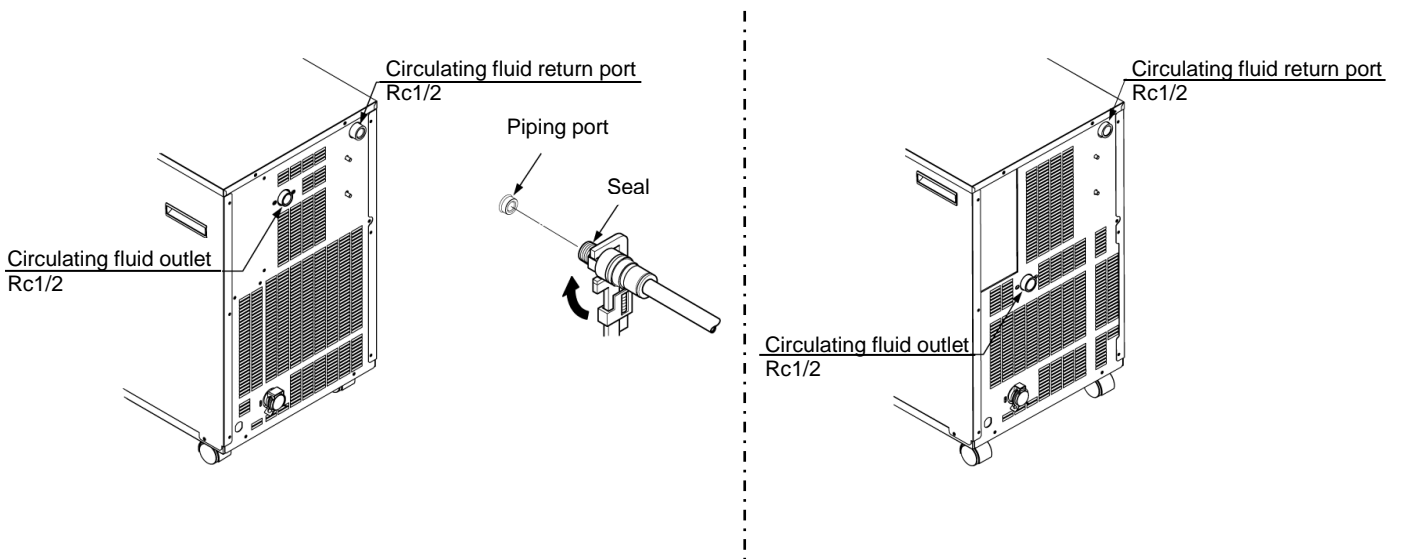

Fig. 3.4-1 Tightening of piping

■ **Recommended piping circuit**

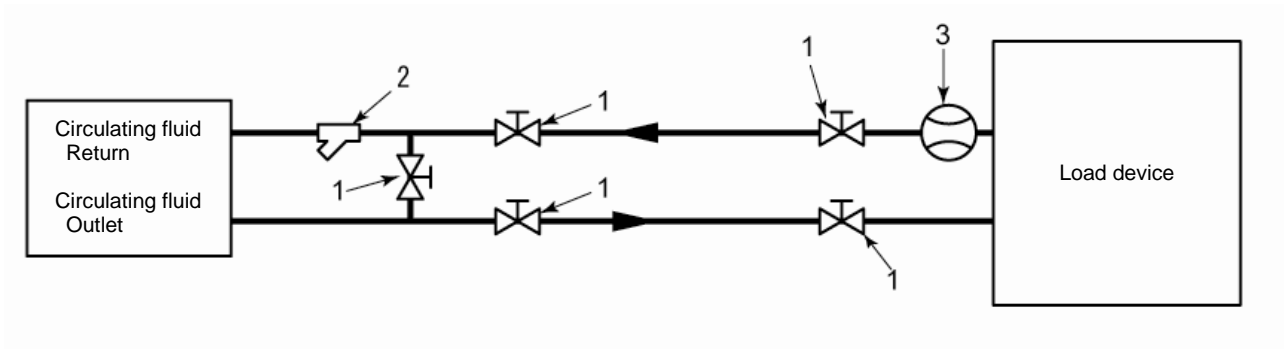

Fig. 3.4-2 Recommended piping circuit

No.	Name	Size
1	Valve	Rc1/2
2	Y-shaped strainer or filter	Rc1/2 (#40) Rc1/2 (500µm)
3	Flow meter	0 to 30 L/min
4	Others (Pipe, hose, etc.)	I.Dφ15more

3.5 Fill of circulating fluid

Turn the tank lid anticlockwise to open. Supply the circulating fluid up to the “H” mark on the fluid level indicator. Use tap water which satisfies the water quality standard shown in Table 7-1, or a 15% aqueous solution of ethylene glycol.

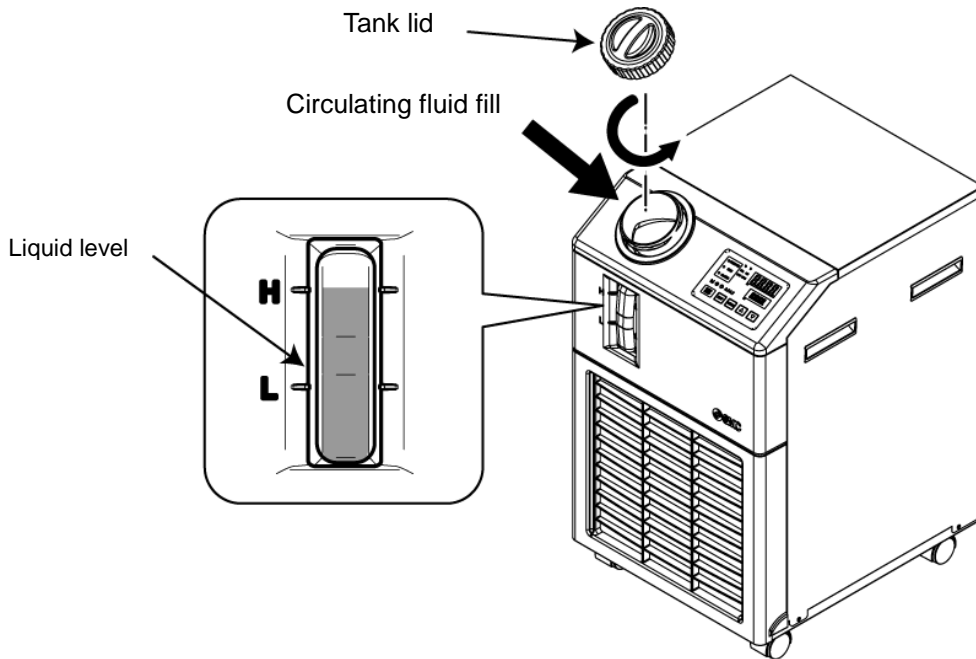



Fig. 3.5-1 Circulating fluid fill

CAUTION	
	<ul style="list-style-type: none"> ● Check the drain port is plugged or closed by the valve to prevent the supplied circulating fluid from draining out. ● Supply the circulating fluid up to the “H” mark on the tank. If the liquid level in the tank becomes lower than the "L" level or the circulating fluid flow becomes 4L/min or less, the thermo chiller stops operation.

■ **15% aqueous solution of ethylene glycol**

When a 15% aqueous solution of ethylene glycol is used, prepare the ethylene glycol aqueous solution separately.
 To control the concentration of the ethylene glycol aqueous solution, a concentration meter is available separately from SMC.

Item	No	Remarks
Ethylene glycol aqueous solution 60%	HRZ-BR001	Please dilute to 15% with tap water and use it.
Densitometer	HRZ-BR002	—

Chapter 4 Starting the Product

CAUTION



Only people who have sufficient knowledge and experience about the product and its accessories are allowed to start and stop the product.

4.1 Before Starting

Check the following items before starting the product.

■ Installation conditions

- Check the product is installed horizontally.
- Check that there are no heavy objects on the product, and the external piping is not applying excessive force to the product.

■ Connection of cables

- Check the power cables are correctly connected.

■ Circulating fluid

- Check proper connection of piping at inlet and outlet.

■ Fluid level indicator (for tank)

- Ensure that the fluid level is on "H".

4.2 Preparation for Start

4.2.1 Power supply

Turn ON the electrical leakage breaker of the user's equipment, and supply power to the thermo chiller.

* For 100 V power supply specification, connect the plug to the outlet with grounding (JIS C8303 Plug for the receptacle for 15A and 125 V with dipole grounding electrodes).

When the product is switched on, the operation panel displays the following conditions.

- The initial screen (HELLO screen) is displayed for 8 seconds on the operation display panel. Then, the display changes to the main screen which displays the circulating fluid outlet temperature.
- The set value of circulating fluid temperature is displayed as SV on the panel.
- The present value of circulating fluid temperature is displayed as PV on the panel.

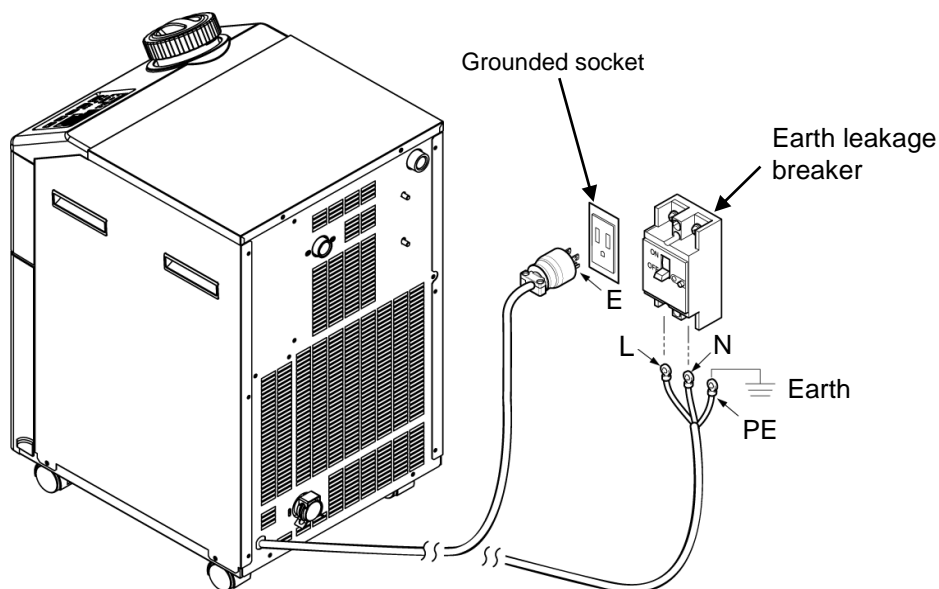

Fig. 4.2-1 Power supply

4.2.2 Setting of circulating fluid temperature

Press the [▼] and [▲] buttons on the operational panel to change the SV to required value.

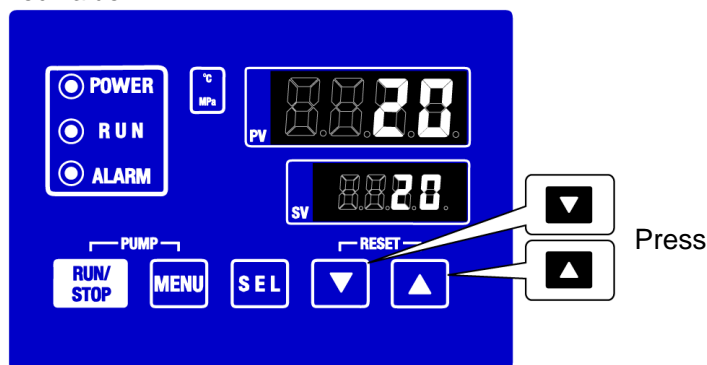

Fig. 4.2-2 Setting of circulating fluid temperature

4.3 Preparation of circulating fluid

When the circulating fluid tank is filled the user's machine and piping remains empty. In that condition, the circulating fluid flows out to the user's machine and piping and the tank level decreases and may require a refill. In that case, refill the circulating fluid in the following procedure.

1. Press the [PUMP] key on the operation display panel (press the [RUN/STOP] key and [MENU] key simultaneously).

The pump operates independently while the [PUMP] key is pressed. The [RUN] lamp (green) flashes while the pump is operating independently, and the circulating fluid in the tank is supplied to the customer's device and piping. This can be done to check for leakage, and to discharge air from the piping.

When the fluid level in the tank drops below the "L" level, stop the operation of the pump itself, and add some circulating fluid into the tank. Repeat the same sequence after adding the fluid until the fluid level in the tank stops decreasing. When the liquid level in the tank stops decreasing, it means that the circulating fluid is filled completely in the piping of the user's facility.

CAUTION

If leakage occurs due to faulty piping including an opened fitting of eternal piping, stop manual operation of the pump and fix the leak.

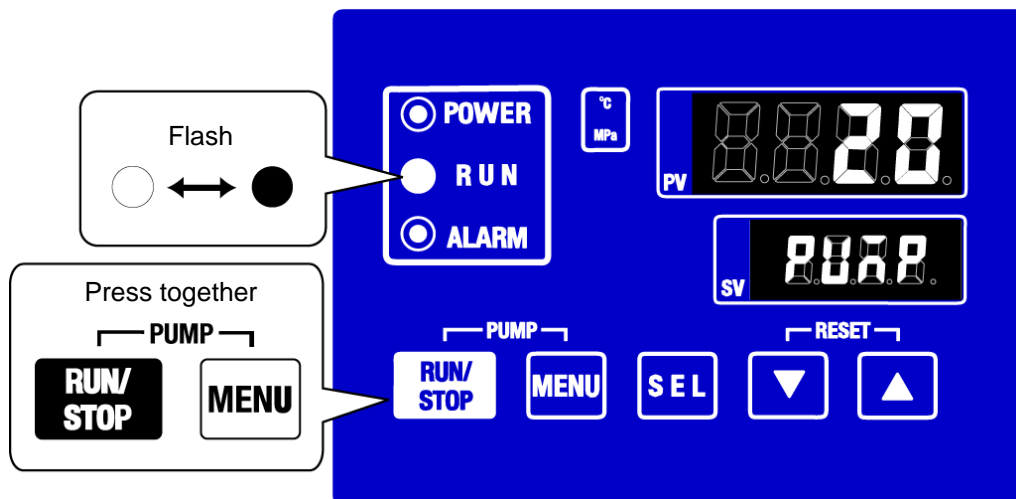

Fig. 4.3-1 Manual operation of the pump

2. Open the tank lid and supply the circulating fluid up to the “H” mark on the tank.

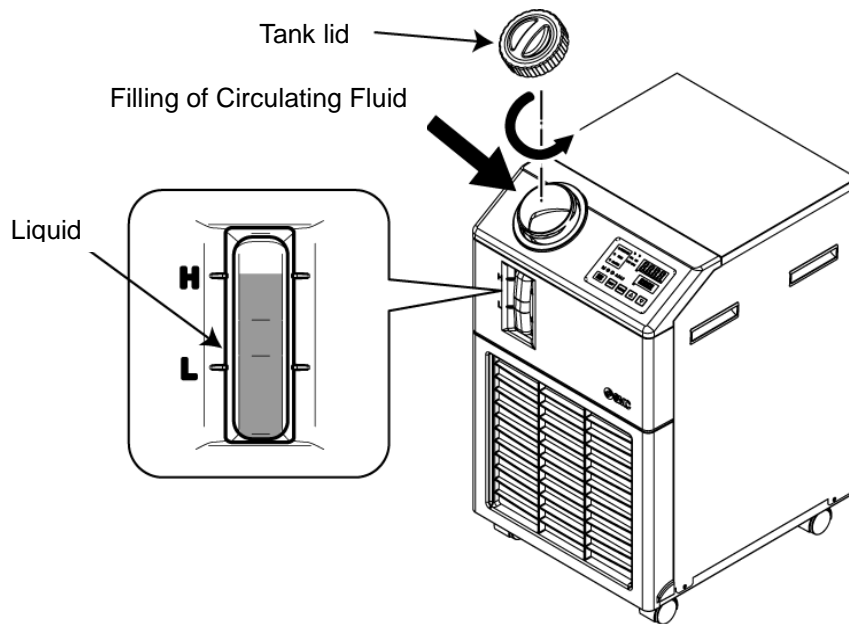

Fig. 4.3-2 Filling of Circulating Fluid

CAUTION



- Confirm that the drain port is closed with a plug or a valve to avoid discharging the circulating fluid that is added to the tank from the drain port.
- Supply the circulating fluid up to the “H” mark on the tank.

4.4 Starting and Stopping

4.4.1 Starting the product

CAUTION

 • Allow at least five minutes before restarting the product.

Before starting, check the items specified in “4.1 Before Starting”

If any alarm lamp remains on, refer to Chapter 6 Alarm indication and trouble shooting”

1. Press the [RUN/STOP] key on the operation panel.

The [RUN] lamp lights up (in green) and the product starts running. The circulating discharge temperature (PV) is controlled to the set temperature (SV).

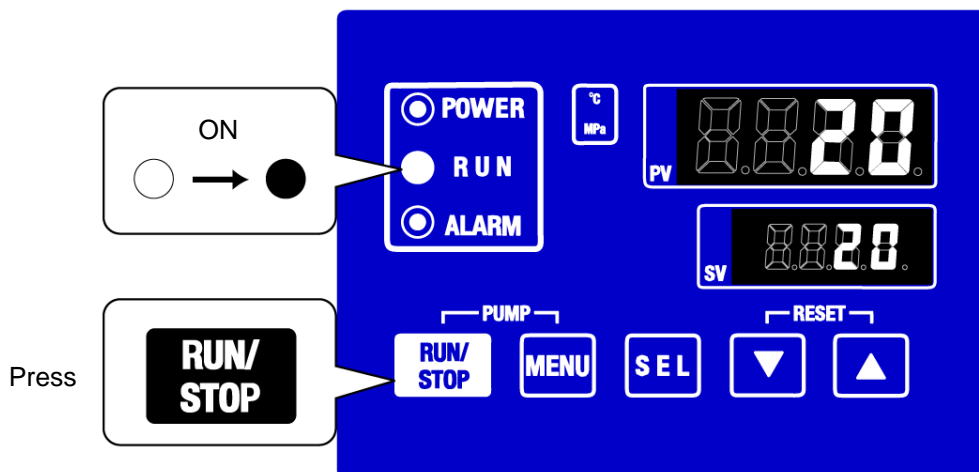

Fig. 4.4-1 Starting the product

CAUTION

When an alarm occurs Refer to “Chapter 6 Alarm indication and trouble shooting”

4.4.2 Stopping the product

1. Press the [RUN/STOP] button on the operation panel.

The [RUN] lamp on the operation panel flashes green at 1 second intervals, and continues operation to prepare to stop. After approx. 15 seconds, the [RUN] lamp goes off and the product stops.

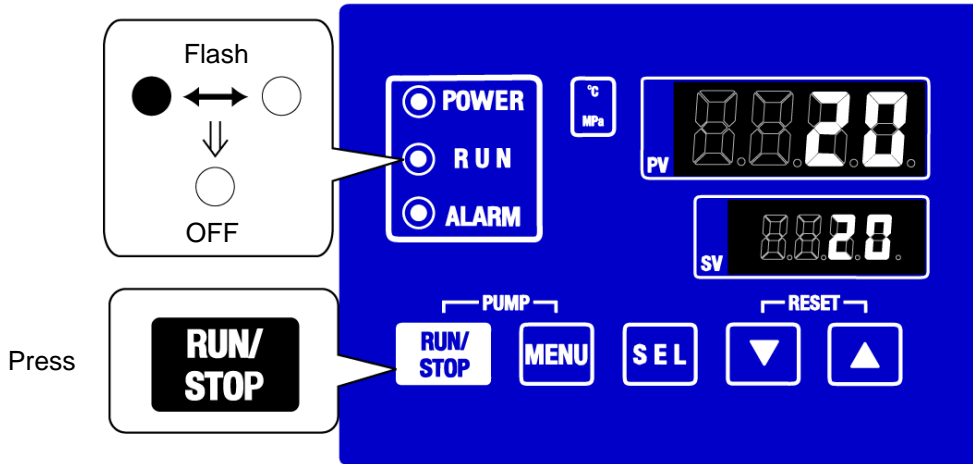

Fig. 4.4-2 Stopping the product

2. Turn OFF the electrical leakage breaker of the user's equipment, and disconnect the power supply to the thermo chiller.

WARNING



Be sure to shut off the breaker of the facility power supply (the user's machine power supply) before wiring. Also, drain the circulating fluid, etc. from the product in accordance with and put into storage properly (Referring to "7.4.1 Discharge of the circulating fluid".)



CAUTION



Except in case of emergency, do not turn off the power supply switch until the product has stopped completely. Doing so could cause failure.

4.5 Check items after starting

Check the following items after starting the product.

 WARNING	
	When an Alarm is seen, press the [STOP] button and then turn off the power supply switch to stop the product, and turn off the breaker of the user's power supply to isolate the product.

- There is no leakage from piping.
- There is no drain of circulating fluid from the drain port.
- The tank level is within the specified range.

4.6 Adjustment of Circulating Fluid

■ Flow adjustment

If the flow rate is less than 5L/min it will not be able to achieve the specified cooling capacity. The adjustment of flow rate should be performed using a manual bypass valve and monitoring the pressure or flow rate in the customer's device, referring to the recommended piping flow shown in Figure 3.4-2, until they reach the required value.

- When the flow rate of the circulating fluid becomes 4L/min. or lower, a protective device of the thermo chiller operates to stop its operation. ("AL07" alarm will be generated.)
- Please reconsider the piping of the equipment that the product is connected to, or consider using the "Bypass piping set; HRS-BP001" that is available as an option.

Chapter 5 Display and setting of various functions

⚠ WARNING



Read and understand this manual carefully before changing the settings.

5.1 Function

5.1.1 Key operations

The product can have the displays and settings shown in table 5-1.

Table 5-1 List of function

NO	Function	Outline	Reference page
1	Main display	Displays the current temperature of the circulating fluid, discharge pressure of the circulating fluid, change the circulating fluid temperature.	5.2
2	Alarm display menu	Indicates alarm number when an alarm occurs.	5.3
3	Inspection monitor menu	Product temperature, pressure and accumulated operating time can be checked as daily inspection. Use these for daily inspection.	5.4
4	Setting of alarm buzzer	Alarm sound can be set to on/off.	5.5
5	Alarm customizing	Operation during alarm condition and threshold values can be changed depending on the alarm type.	5.6
6	Data reset	Functions can be reset to the default settings (settings when shipped from the factory).	5.7
7	Accumulation time reset	Reset function when the pump, the fan, or the compressor is replaced. Accumulated time is reset.	5.8
8	Reset after power failure	Start operation automatically after the power supply is turned on.	5.9

5.1.2 Key operations

Fig. 5.1-1 “Key operation (1/2)” and Fig. 5.1-2 “Key operation (2/2)” show the operation of keys of the thermo-chiller.

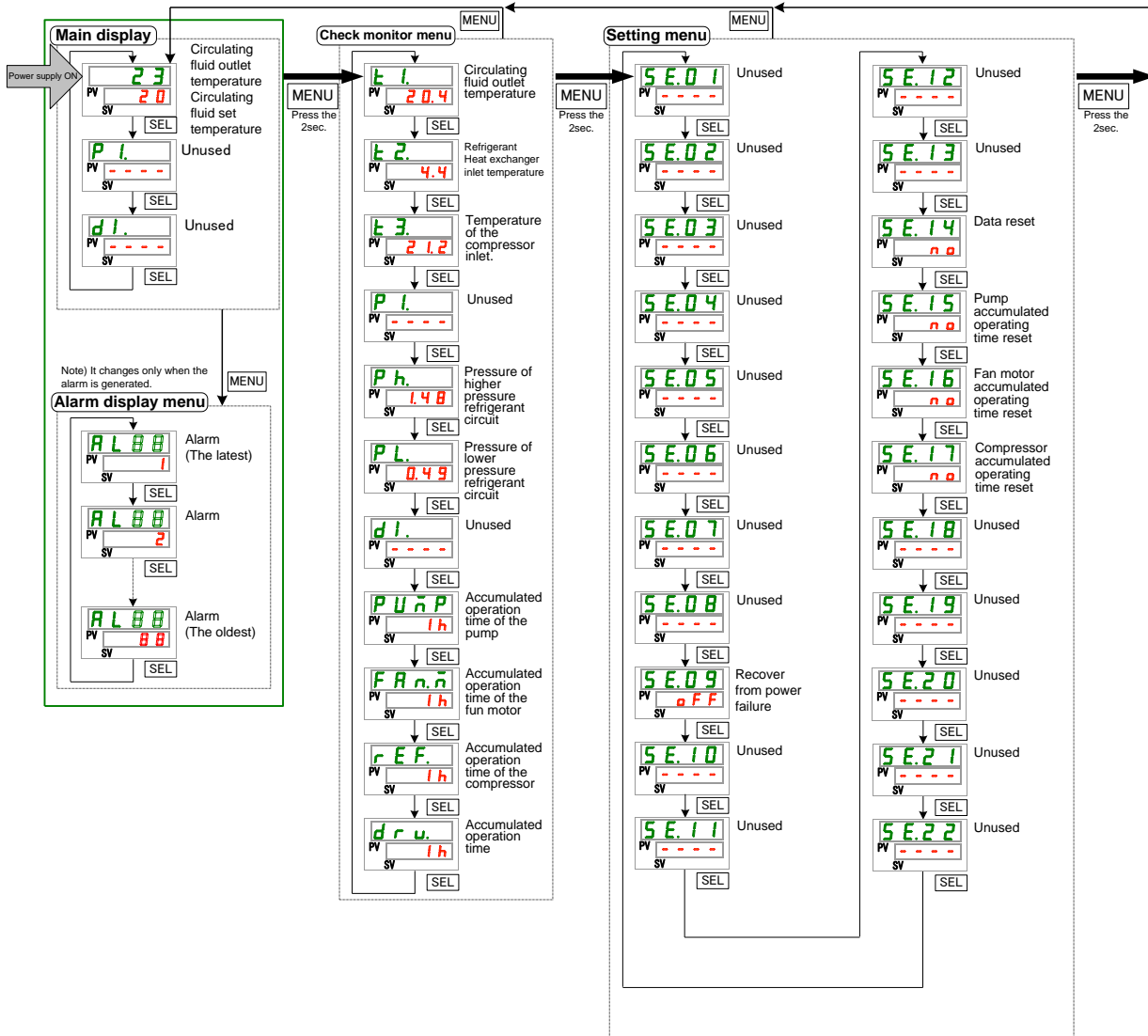

Fig. 5.1-1 Key operation (1/2)

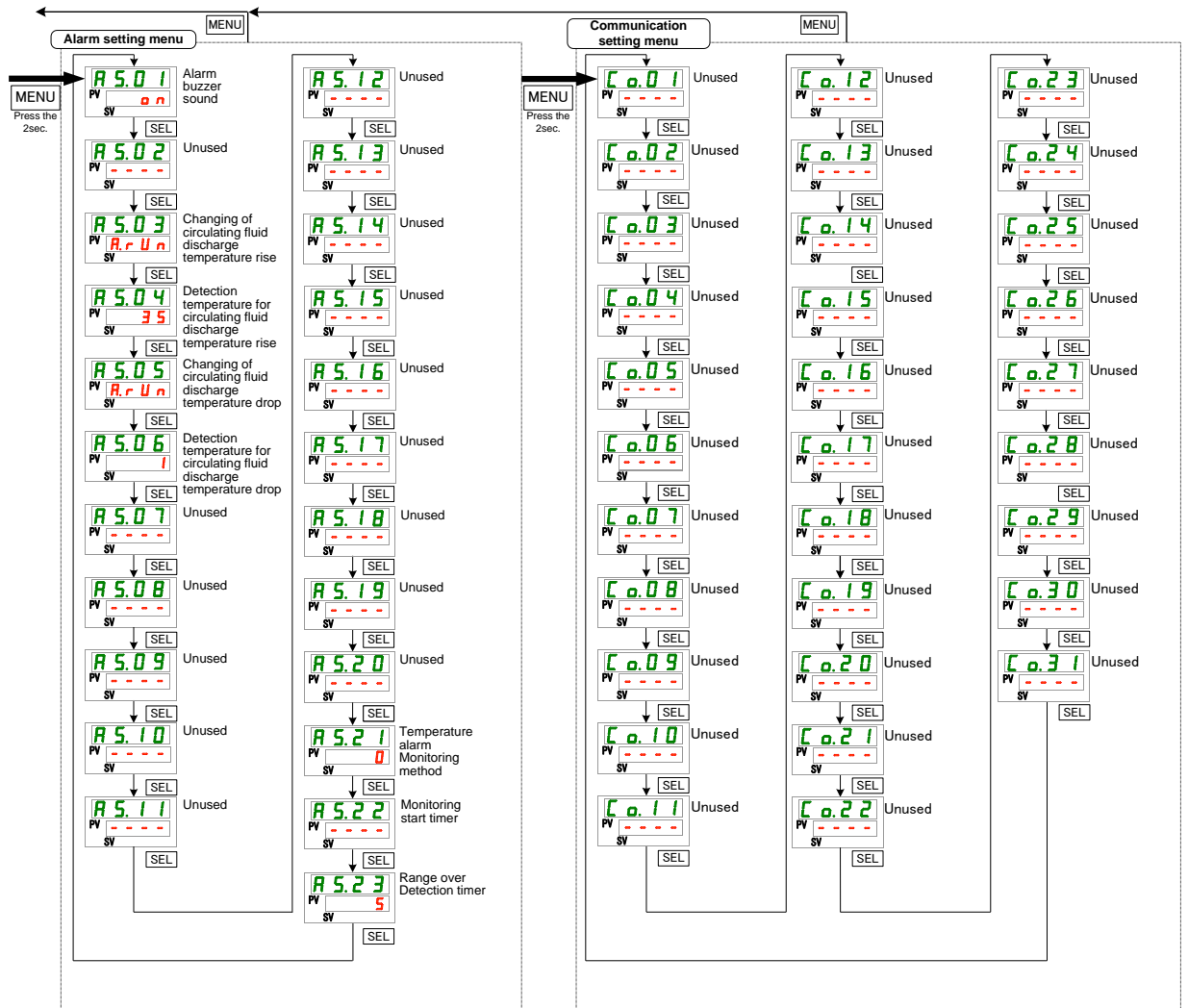

Fig. 5.1-2 Key operation (2/2)

5.1.3 List of parameters

Table 5.1-2“List of parameter (1/3)” and Table 5.1-4“List of parameter (3/3)” show the parameters of the thermo-chiller.

Table 5.1-2 List of parameter (1/3)

Display	Item	Initial value (Default setting)	Reference page	Category
Temperature	Circulating fluid temperature (TEMP PV)		5.2	Main display
	Circulating fluid set temperature (TEMP SV)	20 °C		
	P I.	Unused	-	
d I.	Unused			
AL x x	Alarm no.		5.3	Alarm display menu
E 1.	Circulating fluid outlet temperature		5.4	Check monitor menu
E 2.	Refrigerant Heat exchanger inlet temperature			
E 3.	Temperature of the compressor inlet.			
P I.	Unused			
P h.	Pressure of higher pressure refrigerant circuit			
P L.	Pressure of lower pressure refrigerant circuit			
d I.	Unused			
P U n P	Accumulated operation time of the pump			
F R n n	Accumulated operation time of the fun motor			
r E F.	Accumulated operation time of the compressor			
d r u.	Accumulated operation time			
SE.01	Unused	-	-	Setting menu
SE.02	Unused	-		
SE.03	Unused	-		
SE.04	Unused	-		
SE.05	Unused	-		
SE.06	Unused	-		
SE.07	Unused	-		
SE.08	Unused	-		
SE.09	Recover from power failure	OFF	5.9	
SE.10	Unused	-	-	
SE.11	Unused	-		
SE.12	Unused	-		
SE.13	Pressure unit	-	5.7	
SE.14	Data reset	NO		
SE.15	Pump accumulated operating time reset	NO		
SE.16	Fun motor accumulated operating time reset	NO	5.8	
SE.17	Compressor accumulated operating time reset	NO		
SE.18	Unused	-	-	
SE.19	Unused	-		
SE.20	Unused	-		
SE.21	Unused	-		
SE.22	Unused	-		

Table 5.1-3 List of parameter (2/3)

Display	Item	Initial value (Default setting)	Reference page	Category
A5.01	Alarm buzzer sound	ON	5.5	Alarm setting menu
A5.02	Unused	-	5.6	
A5.03	Changing of circulating fluid discharge temperature rise	A.RUN		
A5.04	Detection temperature for circulating fluid discharge temperature rise	35 °C		
A5.05	Changing of circulating fluid discharge temperature drop	A.RUN		
A5.06	Detection temperature for circulating fluid discharge temperature drop	1 °C		
A5.07	Unused	-		
A5.08	Unused	-		
A5.09	Unused	-		
A5.10	Unused	-		
A5.11	Unused	-		
A5.12	Unused	-		
A5.13	Unused	-		
A5.14	Unused	-		
A5.15	Unused	-		
A5.16	Unused	-		
A5.17	Unused	-		
A5.18	Unused	-		
A5.19	Unused	-		
A5.20	Unused	-	5.6	
A5.21	Temperature alarm Monitoring method	0		
A5.22	Monitoring start timer	-----		
A5.23	Range over Detection timer	5	-	
C0.01	Unused	-		
C0.02	Unused	-		
C0.03	Unused	-		
C0.04	Unused	-		
C0.05	Unused	-		
C0.06	Unused	-		
C0.07	Unused	-		
C0.08	Unused	-		
C0.09	Unused	-		
C0.10	Unused	-		
C0.11	Unused	-		
C0.12	Unused	-		
C0.13	Unused	-		
C0.14	Unused	-		
C0.15	Unused	-		
C0.16	Unused	-		
C0.17	Unused	-		
C0.18	Unused	-		
C0.19	Unused	-		
C0.20	Unused	-		
C0.21	Unused	-		

Table 5.1-4 List of parameter (3/3)

Display	Item	Initial value (Default setting)	Reference page	Category
[p.22]	Unused	-	-	-
[p.23]	Unused	-		
[p.24]	Unused	-		
[p.25]	Unused	-		
[p.26]	Unused	-		
[p.27]	Unused	-		
[p.28]	Unused	-		
[p.29]	Unused	-		
[p.30]	Unused	-		
[p.31]	Unused	-		

5.2 Main screen

5.2.1 Main screen

Displays the current temperature and the set temperature of the circulating fluid. The set temperature can be changed on this screen.

5.2.2 Display on the main screen

The display on the main screen is as follows.

Current discharge temperature of circulating fluid Display

1. Connect the plug of the power supply cable to an outlet to supply power.
Current temperature and set temperature are displayed on the digital display.
Alarm display screen (See 5.3) appears when an alarm is generated.

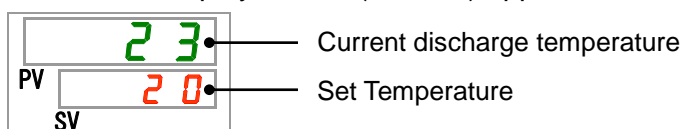

Circulating fluid temperature Set

2. Change the set temperature by pressing the [▼][▲] key.
After changing the set temperature, set it by pressing the [SEL] key.
*The set value flashes while it is being changed.
*If [SEL] key is not pressed, the value is reset after 3 sec.

Circulating fluid discharge pressure Display

3. Press the [SEL] key.
"P1" is displayed, but this feature is not available on this product.



Electric resistivity Display

4. Press the [SEL] key.
"dl" is displayed, but this feature is not available on this product.



5.3 Alarm display menu

5.3.1 Alarm display menu

The alarm display screen appears when an alarm is generated.

- * The alarm display menu cannot be accessed when no alarm has been generated.
- * Refer to “Chapter 6 Alarm indication and trouble shooting” for the content of alarms.

5.3.2 Content of display of alarm display menu

The alarm display screen appears when an alarm is generated.

When multiple alarms are generated, the latest alarm is displayed on the screen.

Each time the [SEL] key is pressed, the alarms are displayed in order, starting from the latest one.

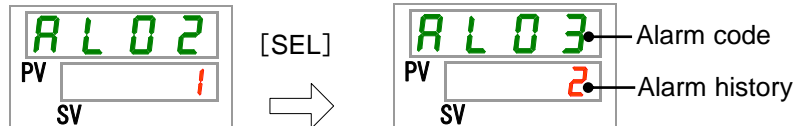

The main screen is displayed when the alarm is reset.



The main screen is displayed when [MENU] key is pressed while an alarm is output.

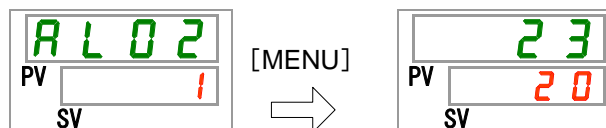

The alarm display screen is displayed if [MENU] key is pressed again.

5.4 Inspection monitor menu

5.4.1 Inspection monitor menu

As a part of the daily inspection, the temperature, pressure and accumulated operating time can be checked.

Please use this for confirmation of your daily inspection.

5.4.2 Checking of the Inspection monitor menu

The table below explains the check items of the inspection monitor menu.

Table 5.4-1 List of check items of Inspection monitor menu

Display	Item	Contents
E 1.	Circulating fluid outlet temperature	Displays the temperature of the circulating fluid outlet. This temperature does not take offset into consideration.
E 2.	Refrigerant Heat exchanger inlet temperature	Displays the temperature of the refrigerant heat exchanger inlet.
E 3.	Temperature of the inlet of the compressor	Displays the temperature of the inlet of the compressor.
P 1.	Circulating fluid outlet pressure	Displays the circulating fluid outlet pressure at the outlet.
P h.	Pressure of higher pressure refrigerant circuit	Displays the pressure of higher pressure side of the refrigerant circuit.
P L.	Pressure of lower pressure refrigerant circuit	Displays the pressure of lower pressure side of the refrigerant circuit.
d l.	Electric resistivity	Displays the electric resistivity.
P U n P	Accumulated operation time of the pump	Displays the accumulated operation time of the pump.
F R n n	Accumulated operation time of the fan motor	Displays the accumulated operation time of the fan motor. (For air-cooled type)
r E F.	Accumulated operation time of the compressor	Displays the accumulated operation time of the compressor.
d r u.	Accumulated operation time	Displays the accumulated operation time.

Check of the circulating fluid outlet temperature

1. Press and hold the [MENU] key for approx. 2 sec.

The temperature of the circulating fluid outlet 「E 1.」 is displayed on the digital display.

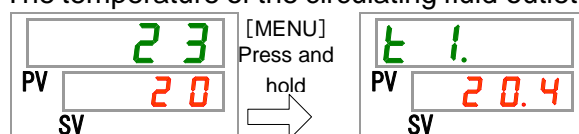

Displays the temperature of the circulating fluid at the outlet from which the fluid is fed to the customer's device.

2. Press the [SEL] key once.

The temperature of the refrigerant heat exchanger inlet is displayed on the digital display.

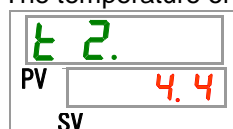

Check of the temperature of the inlet of the compressor.

3. Press the [SEL] key once.

The temperature of the refrigerant circuit compressor inlet is displayed on the digital display.

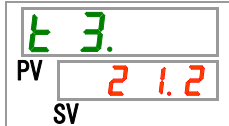

Displays the temperature of the compressor inlet.

4. Press the [SEL] key once.

"P1" is displayed, but this feature is not available on this product.

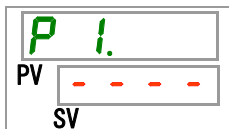

Check of the pressure of the higher pressure side of the refrigerant circuit

5. Press the [SEL] key once.

The pressure of higher pressure refrigerant circuit is displayed on the digital display.

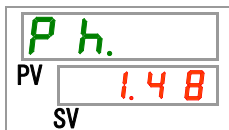

Displays the pressure of the higher pressure side of the refrigerant circuit.

Check of the pressure of the lower pressure side of the refrigerant circuit

6. Press the [SEL] key once.

The pressure of lower pressure refrigerant circuit is displayed on the digital display.

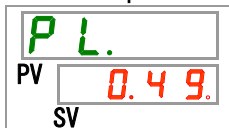

Displays the pressure of the lower pressure side of the refrigerant circuit.

Displayed only when the compressor is operating.

7. Press the [SEL] key once.

"d1" is displayed, but this feature is not available on this product.

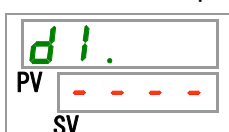

Check of the accumulated operation time of the pump

8. Press the [SEL] key once.

The accumulated operation time of the pump is displayed on the digital display.



Displays the accumulated operation time of the pump. Refer to the table below for the display.

Table 5.4-2 List of time display

Cumulative time	Indicated value
0h to 999h	0 h to 999 h
1,000h to 99,999h	1 h h to 99 h h
100,000h	Return to 0 h

AL28 Pump maintenance alarm is generated when the accumulated operation time of the pump reaches 20,000 hours (20 h h) or more. For details, refer to Chapter 6 Alarm indication and trouble shooting.

Check of the accumulated operation time of the fan motor

9. Press the [SEL] key once.

The accumulated operation time of the fan motor is displayed on the digital display.

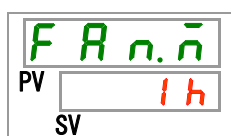

Displays the accumulated operation time of the fan motor. Refer to Table 5.4-2 for the display.

AL29 Fan motor maintenance alarm is generated when the accumulated operation time of the fan motor reaches 20,000 hours (20 h h) or more. For details, refer to Chapter 6 Alarm indication and trouble shooting.

Check of the accumulated operation time of the compressor

10. Press the [SEL] key once.

The accumulated operation time of the compressor is displayed on the digital display.



Displays the accumulated operation time of the compressor. Refer to Table 5.4-2 for the display.

AL30 Compressor maintenance alarm is generated when the accumulated operation time of the compressor reaches 50,000 hours (50 h h) or more. For details, refer to Chapter 6 Alarm indication and trouble shooting.

Check of the accumulated operation time

11. Press the [SEL] key once.

The accumulated operation time is displayed on the digital display.

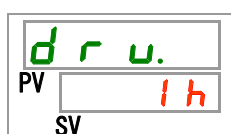

Displays the accumulated operation time. Refer to Table 5.4-2 for the display.

5.5 Alarm buzzer sound setting

5.5.1 Alarm buzzer sound setting

This sets whether a warning sound is made or not when alarm signal is output.

The default setting is buzzer sound ON.

5.5.2 Alarm buzzer sound setting and checking

The table below explains the setting items of the alarm buzzer sound and the initial values.

Table 5.5-1 List of set alarm buzzer sound

Display	Item	Contents	Initial value (Default setting)
A 5.0 1	Alarm buzzer sound	Sets alarm buzzer sound.	ON

1. Press and hold the [MENU] key for approx. 2 sec.

Repeat pressing the key until the setting screen for alarm buzzer sound [A 5.0 1] appears on the digital display.

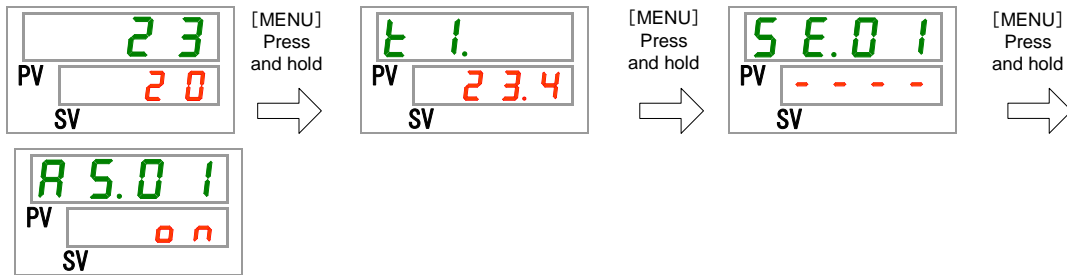

Alarm buzzer sound Setting and checking

2. Select alarm buzzer sound from the table below with [▲] key or [▼] key, and confirm by pressing "SEL".

Table 5.5-2 List of set value

Set value	Explanation	Initial value (Default setting)
o F F	No alarm buzzer sound	
o n	Alarm buzzer sound	✓

3. Press the [MENU] key once.

Return to the main screen (screen displaying the circulating fluid temperature).

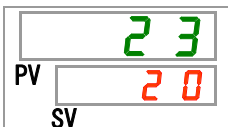

5.6 Alarm customize function

5.6.1 Alarm customize function

The operation and the threshold when alarm signal is output can be customized. Customers should set them depending on their applications.

The alarms below can be customized.

- AL03 Circulating fluid discharge temp. rise (Refer to Table 5.6-3 and Table 5.6-4)

Operation: When this alarm signal is output, user can choose to stop/continue operation, or not to detect this alarm.

"Operation continue" is default setting.

Threshold change: Temp. setting at which the alarm is generated can be changed, and also, the alarm generating conditions can be set.

"35°C" is default setting.

- AL04 Circulating fluid discharge temp. (Refer to Table 5.6-5 and Table 5.6-6)

Operation: When this alarm signal is output, user can choose to stop/continue operation, or not to detect this alarm.

"Operation continue" is default setting.

Threshold change: Temp. setting at which the alarm is generated can be changed, and also, the alarm generating conditions can be set.

"1°C" is default setting.

5.6.2 Alarm customize function setting and checking

The table below explains the setting items of the alarm customize function and the initial values.

Table 5.6-1 List of set alarm customize function (1/2)

Display	Item	Contents	Initial value (Default setting)
R5.03	Changing of circulating fluid discharge temperature rise	Set the operation when alarm No. AL03 "circulating fluid discharge temperature rise" is generated.	A.RUN
R5.04	Detection temperature for circulating fluid discharge temperature rise	Sets the detection temperature for the alarm of alarm NO. AL03 "circulating fluid discharge temperature rise". Alarm signal is generated when the temperature becomes higher than this temperature.	35 °C
R5.05	Changing of circulating fluid discharge temperature drop	Set the operation when alarm No. AL04 "circulating fluid discharge temperature drop" is generated.	A.RUN
R5.06	Detection temperature for circulating fluid discharge temperature drop	Sets the detection temperature for the alarm of alarm NO. AL04 "circulating fluid discharge temperature drop". Alarm signal is generated when the temperature becomes lower than this temperature.	1 °C
R5.21	Temperature alarm Monitoring method	One alarm monitoring method can be selected from four methods for AL04 "Detection temp for the circulating fluid discharge temp. increase" and AL06 "Detection temp. for circulating fluid discharge temp. drop".	0

Table 5.6-2 List of set alarm customize function(2/2)

Display	Item	Contents	Initial value (Default setting)
A 5.22	Monitoring start timer	Alarm will not be generated during the set period of time after starting operation. Alarm monitoring starts when it reaches the set time.	----
A 5.23	Range over Detection timer	After starting the alarm monitoring, the alarm will not be generated right away and will be kept not generated for the set period of time for AL04 "Detection temp for the circulating fluid discharge temp. increase" and AL06 "Detection temp. for circulating fluid discharge temp. drop", when the temperatures goes out of the set range.	5

1. Press and hold the [MENU] key for approx. 2 sec.

Repeat pressing the key until the setting screen for alarm buzzer sound [A 5.01] appears on the digital display.

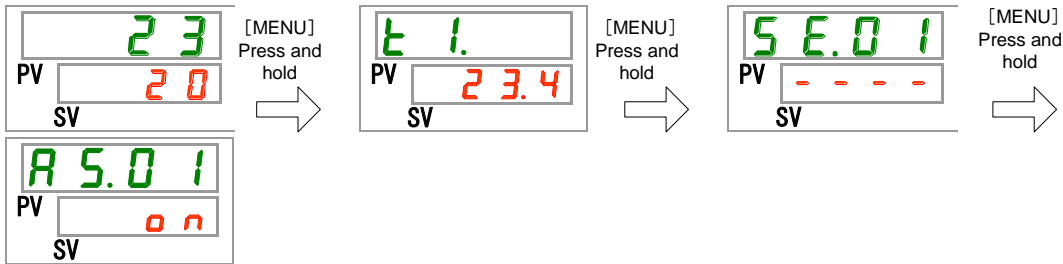

2. Press the [SEL] key once.

"AS02" is displayed, but this feature is not available on this product.



Changing of circulating fluid discharge temperature rise Setting and checking

3. Press the [SEL] key once.

The set screen of changing of circulating fluid discharge temperature rise is displayed on the digital display.

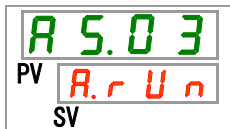

4. Select changing of circulating fluid discharge temperature rise from the table below with [▲] key or [▼] key, and confirm by pressing "SEL".

Table 5.6-3 List of set value

Set value	Explanation	Initial value (Default setting)
o F F	This alarm signal is not detected.	

A.r U n	Operation continues when this alarm signal is generated.	✓
A.S t P	Operation is stopped when this alarm signal is generated.	

Detection temperature for circulating fluid discharge temperature rise Setting and checking

5. Press the [SEL] key once.

The set screen of detection temperature for circulating fluid discharge temperature rise is displayed on the digital display.



6. Select detection temperature for circulating fluid discharge temperature rise from the table below with [▲] key or [▼] key, and confirm by pressing "SEL".

Table 5.6-4 List of set value

Set value	Explanation	Initial value (Default setting)
---	Setting/checking are not available if the setting of the circulating fluid discharge temperature rise is OFF.	
Centigrade 1 0 to 3 8	Sets detection temp for the circulating fluid discharge temperature rise. Temperature unit is Centigrade : Setting unit is 1°C	3 5

Changing of circulating fluid discharge temperature drop setting and checking

7. Press the [SEL] key once.

The set screen of changing of circulating fluid discharge temperature drop is displayed on the digital display.



8. Select changing of circulating fluid discharge temperature drop from the table below with [▲] key or [▼] key, and confirm by pressing "SEL".

Table 5.6-5 List of set value

Set value	Explanation	Initial value (Default setting)
o F F	This alarm signal is not detected.	
A.r U n	Operation continues when this alarm signal is generated.	✓
A.S t P	Operation is stopped when this alarm signal is generated.	

Detection temperature for circulating fluid discharge temperature drop Setting and checking



9. Press the [SEL] key once.

The set screen of detection temperature for circulating fluid discharge temperature drop is displayed on the digital display.

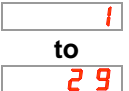

- 10.** Select detection temperature for circulating fluid discharge temperature drop from the table below with [▲] key or [▼] key, and confirm by pressing "SEL".

Table 5.6-6 List of set value

Set value	Explanation	Initial value (Default setting)
	Setting/checking are not available if the setting of the circulating fluid discharge temperature drop is OFF.	
Centigrade 	Sets detection temp for the circulating fluid discharge temperature drop. Temperature unit is Centigrade : Setting unit is 1°C	

- 11.** Press the [SEL] key once.

"AS07" is displayed, but this feature is not available on this product.

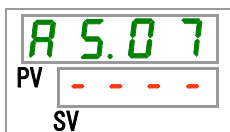

- 12.** Press the [SEL] key once.

"AS08" is displayed, but this feature is not available on this product.



- 13.** Press the [SEL] key once.

"AS09" is displayed, but this feature is not available on this product.

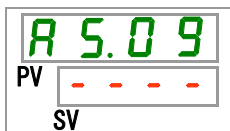

- 14.** Press the [SEL] key once.

"AS10" is displayed, but this feature is not available on this product.

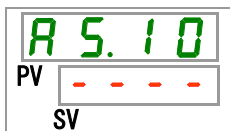

15. Press the [SEL] key once.

"AS11" is displayed, but this feature is not available on this product.

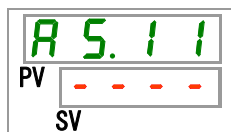

16. Press the [SEL] key once.

"AS12" is displayed, but this feature is not available on this product.



17. Press the [SEL] key once.

"AS13" is displayed, but this feature is not available on this product.



18. Press the [SEL] key once.

"AS14" is displayed, but this feature is not available on this product.

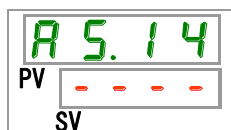

19. Press the [SEL] key once.

"AS15" is displayed, but this feature is not available on this product.



20. Press the [SEL] key once.

"AS16" is displayed, but this feature is not available on this product.

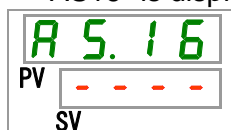

21. Press the [SEL] key once.

"AS17" is displayed, but this feature is not available on this product.

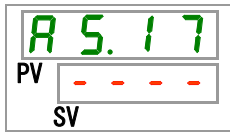

22. Press the [SEL] key once.

"AS18" is displayed, but this feature is not available on this product.



23. Press the [SEL] key once.

"AS19" is displayed, but this feature is not available on this product.



24. Press the [SEL] key once.

"AS20" is displayed, but this feature is not available on this product.



How to monitor the temperature alarm Setting and Checking



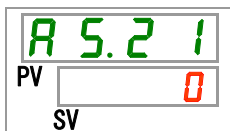

25. Press the [SEL] key once.

Setting screen of the temperature alarm monitoring method is displayed on the digital display.



26. Select temperature alarm monitoring method from the table below with [▲] key or [▼] key, and confirm by pressing "SEL".

Table 5.6-7 List of set value

Set value	Item	Explanation	Initial value (Default setting)
	Continuous monitoring	Alarm monitoring starts at the same time as it is turned ON.	✓
	Automatic monitoring	When the circulating fluid temperature is outside of the alarm threshold range at the time of operation start, the alarm will not be generated until the temperature comes inside the alarm threshold range.	
	Monitoring start timer	Alarm will not be generated until it reaches the time set for the AS.22 "Monitoring start timer" after the operation starts. Alarm monitoring starts when it reaches the set time.	
	Automatic monitoring + Monitoring start timer	Alarm will not be generated until it reaches the time set for the AS.22 "Monitoring start timer" after the operation starts. Alarm monitoring starts when it reaches the set time. When the circulating fluid temperature enters the alarm threshold range before it reaches the set time, the alarm monitoring will be started at that time.	

* Settings of this function and example of alarm generating timing for 5.6.3 "Setting of temperature alarm monitoring method and generation timing".

Monitoring start timer Setting and Checking

27. Press the [SEL] key once.

Setting screen of the monitoring start timer is displayed on the digital display.



28. Select monitoring start timer from the table below with [▲] key or [▼] key, and confirm by pressing "SEL".

Table 5.6-8 List of set value

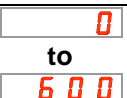
Set value	Explanation	Initial value (Default setting)
	Setting and checking are impossible when "0: Continuous monitoring" or "1: Automatic monitoring" is selected for the setting of AS21 "Temperature alarm monitoring method".	✓
	Sets the time when alarm monitoring starts Setting unit is 1 minute.	

* Settings of this function and example of alarm generating timing for 5.6.3 "Setting of temperature alarm monitoring method and generation timing".

Range over detection timer; Setting and Checking

29. Press the [SEL] key once.

Setting screen of the range over detection timer is displayed on the digital display.

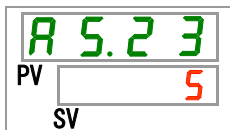

30. Select range over detection timer from the table below with [▲] key or [▼] key, and confirm by pressing "SEL".

Table 5.6-9 List of set value

Set value	Explanation	Initial value (Default setting)
<div style="border: 1px solid black; padding: 2px; display: inline-block;"> 5 </div> to <div style="border: 1px solid black; padding: 2px; display: inline-block;"> 999 </div>	Sets time from detecting the alarm to generation of the alarm. Setting unit is 1 second.	<div style="border: 1px solid black; padding: 2px; display: inline-block;"> 5 </div>

* Settings of this function and example of alarm generating timing for 5.6.3 "Setting of temperature alarm monitoring method and generation timing".

31. Press the [MENU] key once.

Return to the main screen (screen displaying the circulating fluid temperature).

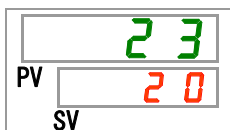

5.6.3 Setting of temperature alarm monitoring method and alarm generation timing

Examples of temperature alarm monitoring method setting and alarm generation timing are shown below.

■ When "Automatic monitoring" is selected

[1] Circulating fluid temperature when starting operation: Approximately 25 °C

[2] Circulating fluid set temperature: 15 °C

[3] "AS.21: Temperature alarm monitoring method": Select "Automatic monitoring".
("----" (invalid setting) will be shown for "AS.22: Monitoring start timer".)

[4] "AS.04: Detection temp. for the circulating fluid discharge temp. increase": Set to "20 °C".

[5] "AS.06: Detection temp. for the circulating fluid discharge temp. drop": Set to "10 °C".

[6] "AS.23: Range over detection timer "Set to "600 sec".

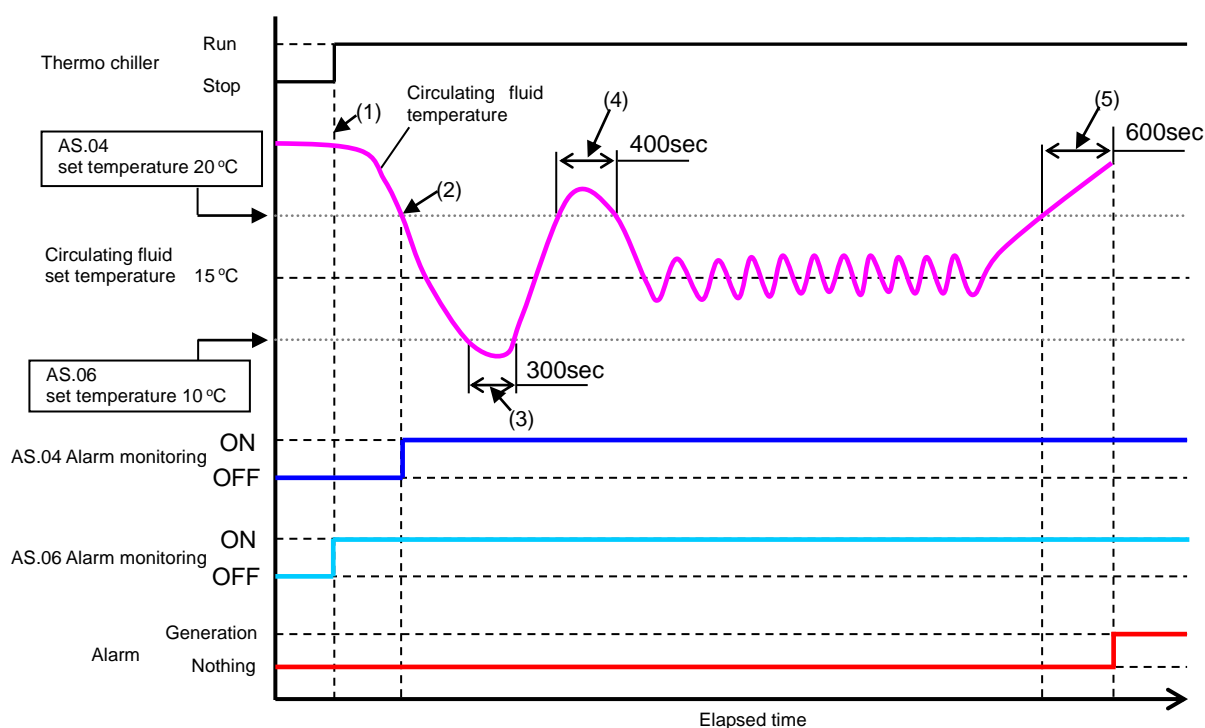

Fig 5.6-1 Alarm generation timing

■ -Alarm generation timing

Status (1): Temperature alarm monitoring starts by starting the chiller operation. As the circulating fluid temperature at this time is 20 °C, "AS.06" starts alarm monitoring at the same time as the operation start.

Status (2): The circulating fluid temperature becomes within the set range of "AS.04", and starts "AS.04" alarm monitoring".

Status (3): The circulating fluid temperature exceeds the threshold of "AS.06", but the alarm will not be generated as it has returned within the 600 sec range of the "AS.23: Range over detecting timer".

Status (4): The circulating fluid temperature exceeds the threshold of "AS.04", but the alarm will not be generated as it has returned within the 600 sec range of the "AS.23: Range over detecting timer".

Status (5): Alarm "AL03: Circulating fluid discharge temp. increase" will be generated after 600 seconds that is set for the "AS.23: Range over detection timer" after the circulating fluid temperature exceeds the threshold of "AS.04".

■ **When "Automatic monitoring + Monitoring start timer" is selected**

- [1] Circulating fluid temperature when starting operation: Approximately 25 °C
- [2] Circulating fluid set temperature: 15 °C
- [3] "AS.21: Temperature alarm monitoring method": Select "Automatic monitoring + Monitoring start timer".
- [4] "AS.22: Monitoring start timer": Set it to "50 min".
- [5] "AS.04: Detection temp. for the circulating fluid discharge temp. increase": Set to "20 °C".
- [6] "AS.06: Detection temp. for the circulating fluid discharge temp. drop": Set to "10 °C".
- [7] "AS.23: Range over detection timer": Set to "600 sec".

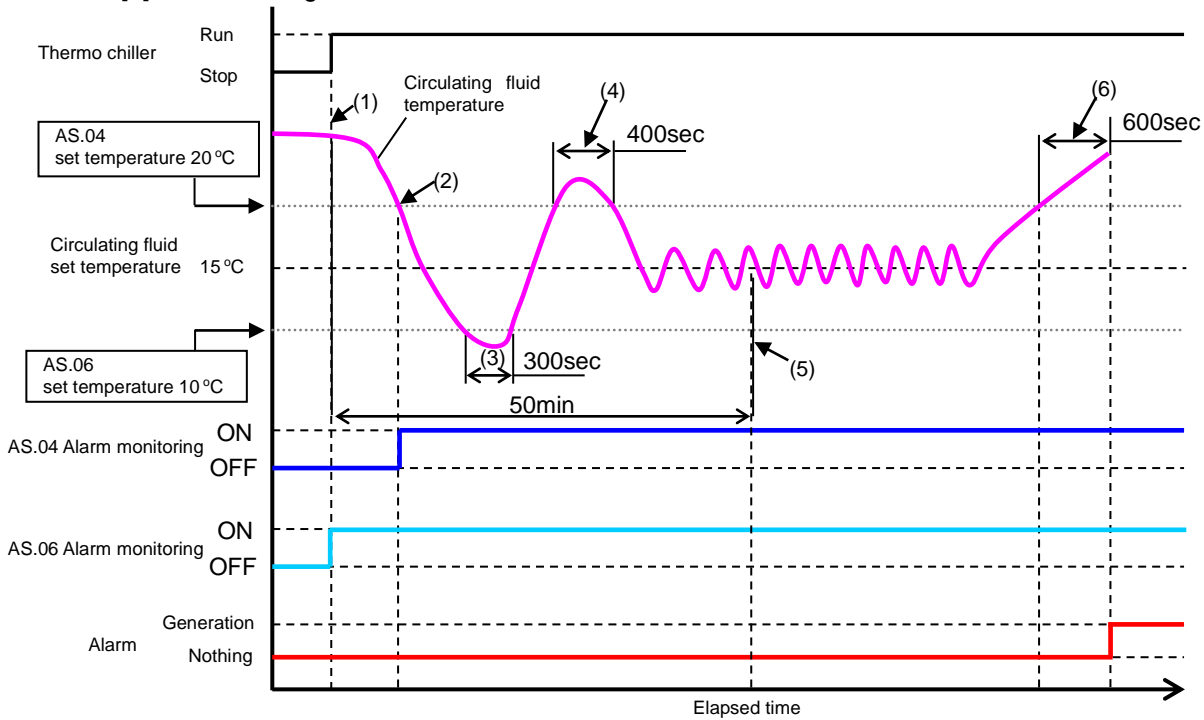

Fig 5.6-2 Alarm generation timing

■ **-Alarm generation timing**

- Status (1): Start operation of the chiller. As the circulating fluid temperature is within the set range of "AS.06", "AS.06" alarm monitoring starts.
- Status (2): The circulating fluid temperature becomes within the set range of "AS.04". "AS.04" alarm monitoring starts.
- Status (3): The circulating fluid temperature exceeds the threshold of "AS.06", but the alarm will not be generated as it has returned within the 600 sec range of the "AS.23: Range over detecting timer".
- Status (4): The circulating fluid temperature exceeds the threshold of "AS.04", but the alarm will not be generated as it has returned within the 600 sec range of the "AS.23: Range over detecting timer".
- Status (5): 50 minutes passes after starting operation. Alarm monitoring has started. It shows that the "50 min" setting does not influence the alarm monitoring under these conditions.
- Status (6): Alarm will be generated after 600 seconds that is set for "AS.23: Range over detection timer" after the circulating fluid temperature exceeds the threshold of "AS.04".

5.7 Data reset function

5.7.1 Data reset function

Values set by customer are reset to default values. Accumulated operating time is not reset.

⚠ CAUTION



All setting values are reset.
It is recommended to record set data before reset.

5.7.2 Method of resetting data reset function

The table below explains the setting items of the data reset and the initial values.

Table 5.7-1 List of data reset

Display	Item	Contents	Initial value (Default setting)
SE.14	Data reset	All data is reset. (Accumulated operation time is not reset.)	NO

1. Press and hold the [MENU] key for approx. 2 sec.

Repeat pressing the key until the setting screen for key-lock [SE.01] appears on the digital display.

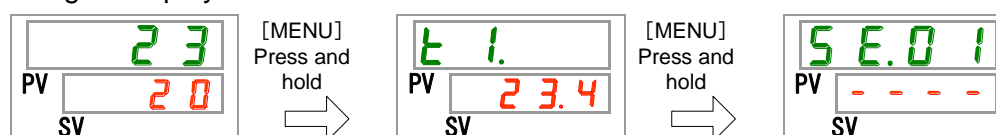

Data reset

2. Press the [SEL] key 13 times.

The set screen of data reset is displayed on the digital display.

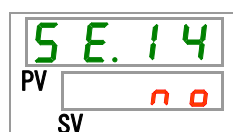

3. Select YES from the table below with [▲] key or [▼] key, and confirm by pressing "SEL". Select YES, then all data returns to default setting. The display returns to the main screen.

Table 5.7-2 List of set value

Set value	Explanation	Initial value (Default setting)
NO	Not reset	✓
YES	All data is reset	

5.8 Accumulated time reset function

5.8.1 Accumulated time reset function

The alarms below are generated to notify the maintenance time.
 The product is not stopped for alarm.

- Pump maintenance (AL28): Generated after 20,000h of accumulated operating time
- Fan motor maintenance (AL29) : Generated after 20,000h of accumulated operating time.
- Compressor maintenance (AL30): Generated after 50,000h of accumulated operating time

To reset the alarm, reset the accumulated operating time.
 Reset the accumulated time after the replacement of parts (call for inspection service).

5.8.2 Method of resetting accumulated time reset function

The table below explains the setting items of the accumulated time reset and the initial values.

Table 5.8-1 List of set accumulated time reset function

Display	Item	Contents	Initial value (Default setting)
SE.15	Pump accumulated operating time reset	Reset the accumulated operating time of the pump.	NO
SE.16	Fan motor accumulated operating time reset	Reset the accumulated operating time of the fan motor. (For air-cooled type)	NO
SE.17	Compressor accumulated operating time reset	Reset the accumulated operating time of the compressor.	NO

Refer to each paragraph for the detail of resetting the accumulated operating time.

1. Press and hold the [MENU] key for approx. 2 sec.

Repeat pressing the key until the setting screen for key-lock [SE.01] appears on the digital display.

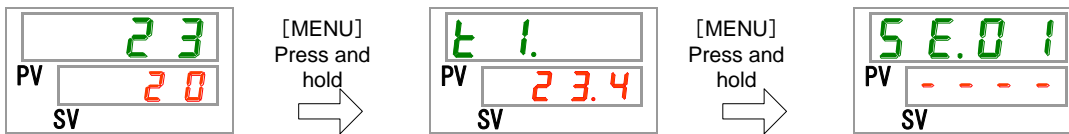

Pump accumulated operating time reset

2. Press the [SEL] key 14 times.

The set screen of pump accumulated operating time reset is displayed on the digital display.

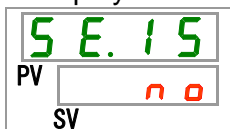

3. Select from the table below with [▲] key or [▼] key, and confirm by pressing "SEL". Select , then the accumulated operating time of the pump is reset. The display returns to the main menu.

Table 5.8-2 List of set value

Set value	Explanation	Initial value (Default setting)
<input type="text" value="no"/>	Not reset	✓
<input type="text" value="YES"/>	Pump accumulated operating time is reset	

Fun motor accumulated operating time reset

4. Press the [SEL] key once.

The set screen of fun motor accumulated operating time reset is displayed on the digital display.

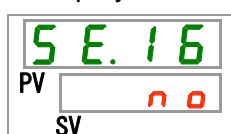

5. Select from the table below with [▲] key or [▼] key, and confirm by pressing "SEL". Select , then the accumulated operating time of the fan motor is reset. The display returns to the main menu.

Table 5.8-3 List of set value

Set value	Explanation	Initial value (Default setting)
<input type="text" value="- - - -"/>	Not possible to reset	
<input type="text" value="no"/>	Not reset	✓
<input type="text" value="YES"/>	Fan motor accumulated operating time is reset	

Compressor accumulated operating time reset

6. Press the [SEL] key once.

The set screen of compressor accumulated operating time reset is displayed on the digital display.

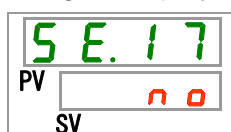

7. Select from the table below with [▲] key or [▼] key, and confirm by pressing "SEL". Select , then the accumulated operating time of the compressor is reset. The display returns to the main menu.

Table 5.8-4 List of set value

Set value	Explanation	Initial value (Default setting)
<input type="text" value="no"/>	Not reset	✓
<input type="text" value="YES"/>	Compressor accumulated operating time is reset	

5.9 Function to recover from power failure

5.9.1 Function to recover from power failure

When the power supply is cut due to power failure etc., this function restarts the operation when the power supply recovers, retaining the conditions before the power cut.

The [POWER] lamp flashes (5 sec.ON - 0.2 sec.OFF) when the power failure recovery is set. The default setting of this function is "OFF".

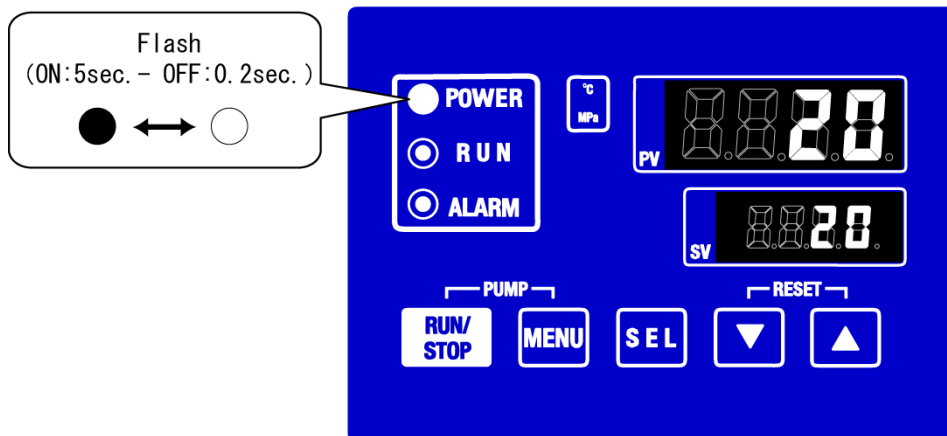

Fig 5.9-1 Setting of function to recover from power failure

5.9.2 Function to recover from power failure setting and checking

The table below explains the setting items of the power recovery function and the initial values.

Table 5.9-1 List of set function to recover from power failure

Display	Item	Contents	Initial value (Default setting)
SE.09	Recover from power failure	Sets recover from power failure.	OFF

1. Press and hold the [MENU] key for approx. 2 sec.

Repeat pressing the key until the setting screen for key-lock [SE.01] appears on the digital display.

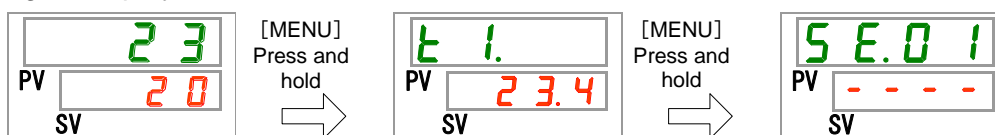

Recover from power failure Setting and checking

2. Press the [SEL] key 8 times.

The set screen of recover from power failure is displayed on the digital display.



3. Select recover from power failure from the table below with [▲] key or [▼] key, and confirm by pressing "SEL".

Table 5.9-2 List of set value

Set value	Explanation	Initial value (Default setting)
OFF	Function to recover from power failure OFF	✓
ON	Function to recover from power failure ON	

4. Press the [MENU] key once.

Return to the main screen (screen displaying the circulating fluid temperature).

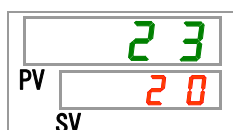

Chapter 6 Alarm indication and trouble shooting

6.1 Alarm Display

When any alarm occurs, the product responds with the following conditions.

- The [ALARM] lamp will flash.
- The alarm buzzer sounds.
- The alarm no. is displayed on PV.
- The thermo-chiller has two types of operation depending on the alarm status.

One alarm type will stop operation when an alarm is generated during operation. The other type will not stop operation even when an alarm is generated.

Refer to the “ Table 6-1 Alarm code list and Troubleshooting6.3Troubleshooting”. When the operation is forced to stop, the product cannot restart until the alarm is reset.

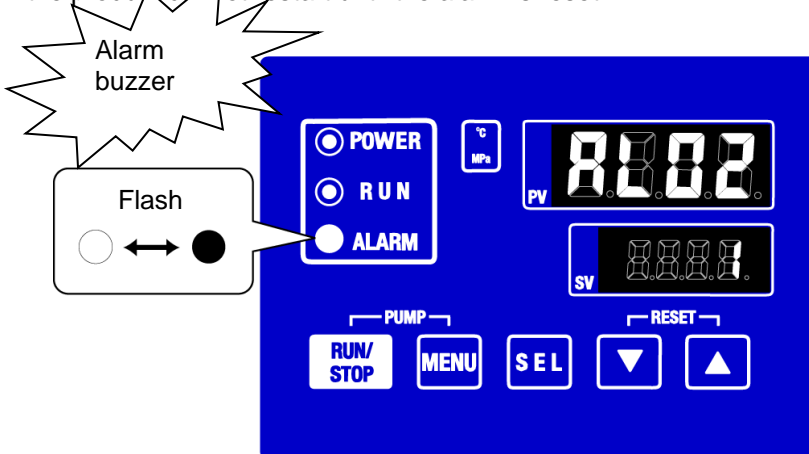

- When multiple alarms are generated, the alarms are displayed one by one by pressing the [SEL] key

Alarm with no.1 on the digital display SV is the latest alarm. The alarm with the highest number is the alarm that was generated first.

【Example of display】

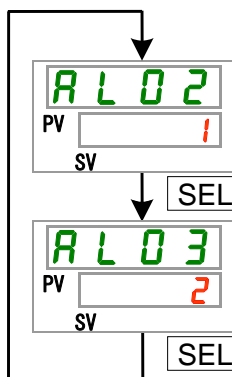

The temperature rises gradually, and alarms are generated in the order AL03, AL02.

The alarm code displayed on the operation panel is AL02. AL03 are displayed by pressing the [SEL] key.

Digital display SV displays “2” when AL03 is displayed. In this example, AL03 is the highest number. This means AL03 is the alarm generated first.

6.2 Alarm buzzer stop

The alarm buzzer sounds to notify when the alarm signal is output. How to stop the alarm buzzer.

- Ensure that the alarm display screen is displayed.

The alarm buzzer can only be stopped on this screen.

- Press [▼] and [▲] keys down simultaneously.
- The alarm buzzer is stopped.

[Tips]

- The alarm buzzer can be set not to make sound. Refer to 5.5 Alarm buzzer sound setting". The procedure to stop the alarm buzzer is not necessary when the buzzer is set not to make a sound.
- If this procedure is performed when the cause of the alarm has been eliminated before stopping the alarm buzzer, the alarm will be reset at the same time.

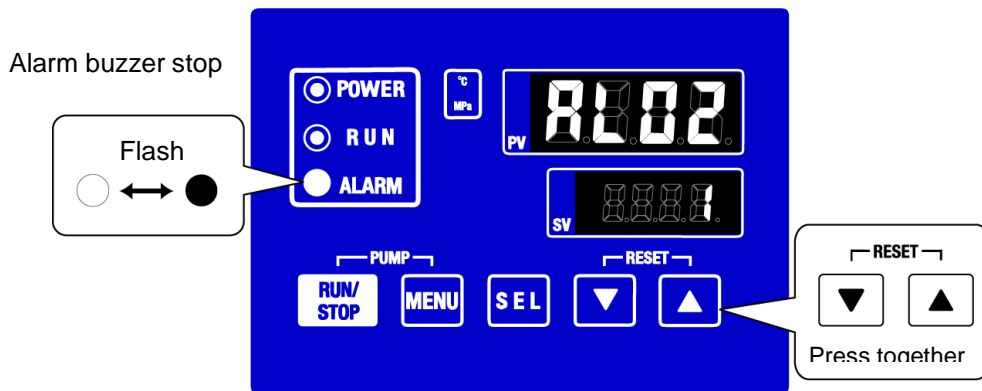

6.3 Troubleshooting

The troubleshooting method depends which alarm has been generated. Refer to "Table 6-1 Alarm code list and Troubleshooting 6.3 Troubleshooting".

This page explains how to reset the alarm signal condition after eliminating the cause of the alarm.

- Ensure that the alarm display screen is displayed.

Alarm can only be reset on this screen.

- Press [▼] and [▲] keys down simultaneously..
- The alarm is reset.

The [ALARM] lamp goes off.

The operation panel displays the circulating fluid temperature and the circulating fluid set temperature.

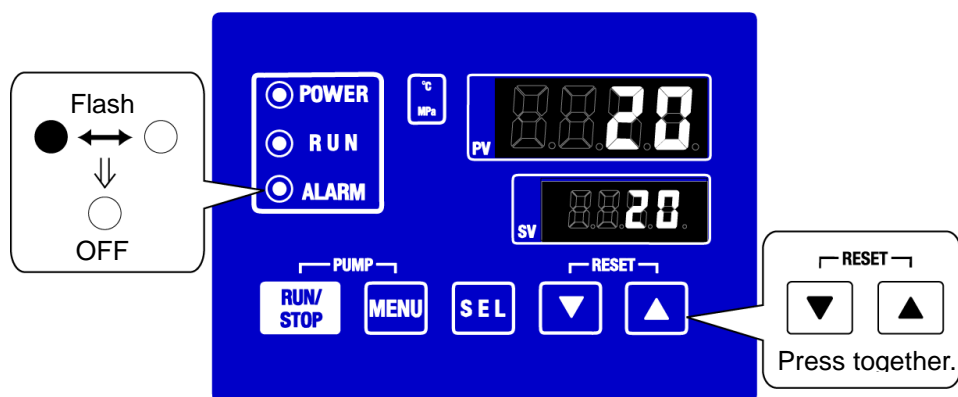

Table 6-1 Alarm code list and Troubleshooting

Code	Description	Operation	Cause / Remedy (Press the reset key after eliminating the cause.)
AL02	High circulating fluid discharge temp.	Stop	- Reduce the ambient temperature or heat load. - Check that the ventilation port is not closed.
AL03	Circulating fluid discharge temp. rise	Continued *1	
AL04	Circulating fluid discharge temp.	Continued *1	Check the ambient temperature condition and the temperature of supplied circulating fluid.
AL07	Abnormal pump operation	Stop	- Flow rate of the circulating fluid is 4L/min. or less. Improve the piping to increase the flow rate to more than 4L/min. - Check the piping and the pump to make sure that no foreign matter in the circulating fluid is clogged in them.
AL15	Refrigerant circuit pressure (high pressure side) drop	Stop	- Check the ambient temperature is within the specified range. - It is possible that refrigerant is leaking. Ask for the service.
AL20	Memory error	Stop	Written data is different from read data. Ask for the service of RAM.
AL22	Circulating fluid discharge temp. sensor failure	Stop	The temperature sensor is short-circuited or opened. Ask for the service of the temperature sensor.
AL24	Compressor intake temp. sensor failure	Stop	
AL26	Compressor discharge pressure sensor failure	Stop	The pressure sensor is short-circuited or opened. Ask for the service of the pressure sensor.
AL27	Heat exchanger inlet temp. sensor failure	Stop	The temperature sensor is short-circuited or opened. Ask for the service of the temperature sensor.
AL28	Maintenance of pump	Continued	The timing of a periodical check is informed. Recommended to ask for the check and service of the pump, fan motor and compressor. *Refer to "5.8 Accumulated time reset function".
AL29	Maintenance of fan motor	Continued	
AL30	Maintenance of compressor	Continued	

*1: "Stop" or "Continued" are default settings. The user can change them to "Continued" and "Stop". For details, refer to "5.6 Alarm customize function".

6.4 Other Errors

■ How to check other errors

The causes and remedies for failures that are not indicated by alarm numbers are shown in "Table 6-2 Causes and remedies for failures without alarm number".

Table 6-3 Causes and remedies for failures without alarm number

Content of failure	Cause	Remedy
The operation panel displays nothing	No power supply	- Turn ON the electrical leakage breaker of the original power supply (the breaker of the user's equipment), and supply power to the thermo chiller. - Connect the plug of the power supply cable to an outlet to supply power.
	Blown fuse	Overcurrent has been caused due to short-circuit, etc. The blown fuse needs to be replaced, and causes of the overcurrent must be removed.
The [RUN] LED does not light up even when the [RUN/STOP] switch is pressed.	Failure of the [RUN] LED	Replace the display.
	Failure of the [RUN/STOP] switch	Replace the display.

Chapter 7 Control, Inspection and Cleaning

7.1 Control of Circulating Fluid Quality

⚠ WARNING



Use specified circulating fluids only. If other fluids are used, they may damage the product or result in dangerous hazards.

When using fresh water (tap water) ensure that it satisfies the water standard shown in the table below.

If the water quality standards are not met, clogging or leakage in the facility water piping, or other problems such as refrigerant leakage, etc., may result.

Table 7-1 Quality standard for fresh water (tap water)

	Item	Product	Standard value
			For circulating fluid
Standard item	pH (at 25°C)	—	6.0 to 8.0
	Electric conductance (at 25°C)	[μS/cm]	100 to 300
	Chloride ion	[mg/L]	50 or less
	Sulfuric acid ion	[mg/L]	50 or less
	Acid consumption (at pH 4.8)	[mg/L]	50 or less
	Total hardness	[mg/L]	70 or less
	Calcium hardness	[mg/L]	50 or less
	Ion silica	[mg/L]	30 or less
Referential item	Iron	[mg/L]	0.3 or less
	Copper	[mg/L]	0.1 or less
	Sulfide ion	[mg/L]	Not detected
	Ammonium ion	[mg/L]	0.1 or less
	Residual chlorine	[mg/L]	0.3 or less
	Separation carbonic acid	[mg/L]	4.0 or less

* Quoted from JRA-GL-02-1994, The Japan Refrigeration and Air Conditioning Industry Association.

CAUTION



Clean the tank, circulating fluid circuit, and change the circulating fluid in the tank if any problems are found during the regular check.

Additionally, even if no problems are found, it is necessary to change the fluid once every 3 months in case evaporation of the fluid causes concentration of impurities. Refer to the page containing "7.2 Inspection and Cleaning" for the regular check.

7.2 Inspection and Cleaning

⚠ WARNING	
	<ul style="list-style-type: none"> ● Do not operate switches, etc. with wet hands and do not touch the electrical parts such as the power supply plug. It might cause electric shock. ● Do not splash water directly on the product and do not wash with water. It might cause electric shock and fire, etc. ● Do not touch the fins directly when cleaning the dustproof filter. It might cause injury.

⚠ WARNING	
	<ul style="list-style-type: none"> ● Shut off the power supply of the product when performing cleaning, maintenance or inspection. It might cause electric shock, injury or burn, etc. ● Replace all panels removed for inspection or cleaning. It might cause injury or electric shock if it is operated with the panel removed or open. Do not operate switches, etc. with wet hands and do not touch the electrical parts such as the power supply plug. It might cause electric shock.

7.2.1 Daily check

Check the items listed below. If any abnormality is found, stop the operation, remove the plug of the power supply cable from the outlet, and ask for maintenance.

Table 7-2 Contents of daily check

Item	Content of check	
Installation condition	Check the installation conditions of the product.	There is no heavy object on the product or excessive force on the piping.
		Temperature and humidity are within the specified range of the product.
Fluid leakage	Check the connected part of piping	There is no circulating fluid leakage from the connected part of piping.
Fluid amount	Check the liquid level indicator.	The circulating fluid must enter the scale of "H".
Operation panel	Check the display.	The numbers on the display are clear.
	Check the function.	The [RUN/STOP] and [MENU], [SEL], [▼], [▲] buttons operate properly.
Circulating fluid temperature	Check on the operation panel.	There is no problem for use.
Operating conditions	Check the operation condition.	There is no abnormal noise, vibration, smell and smoke.

7.2.2 Monthly check

■ Cleaning of air vent

CAUTION

- If the fins of the air-condenser become clogged with dust or debris, heat radiation performance reduces. This results in the reduction of cooling performance, and may stop the operation because the safety device is triggered. Shut off the power supply of the product when performing cleaning, maintenance or inspection. It might cause electric shock, injury or burn, etc.
- Replace all panels removed for inspection or cleaning. It might cause injury or electric shock if it is operated with the panel removed or opened.

Use a long bristled brush or air gun to clean the condenser to prevent the fins from being deformed or damaged.

■ Removal of the dustproof filter

- 1.** The dustproof filter is installed at the lower part of the front face of the thermo-chiller. It is mounted with a magnet. Pull out the lower part of the side surface of the dustproof filter.

- 2.** When the magnet comes off, pull the dustproof filter downwards to remove. Care should be taken not to deform or scratch the air-cooled condenser.

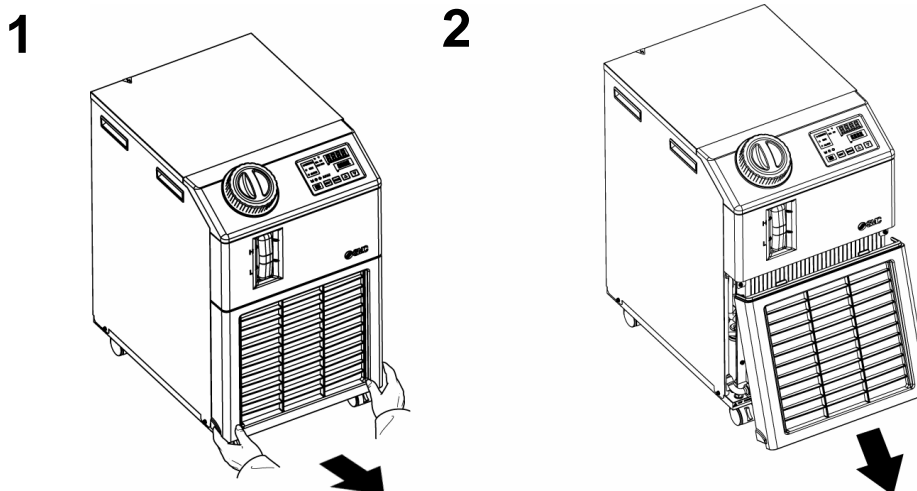

Fig 7.2-1 Removal of the dustproof filter

■ **Cleaning of filter**

Use a long bristled brush or air gun to clean the condenser.

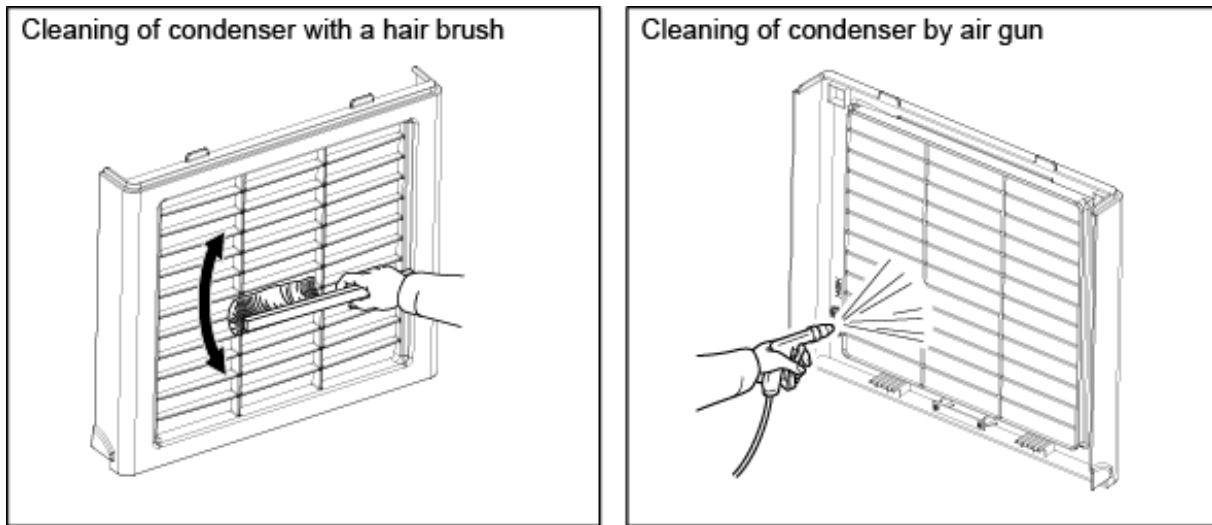

Fig 7.2-2 Cleaning of filter

■ **Mounting of dustproof filter**

Insert the collar in reverse order of removal, then mount the dustproof filter. (The magnet clicks when mounted.)

7.2.3 Inspection every 3 months

■ **Replacement of circulating fluid**

- Clean the tank and replace the circulating fluid (clean water).
- For the circulating fluid, select from the specification range shown in "Table 7-1 Quality standard for fresh water (tap water)".

7.2.4 Inspection for winter season

■ **Prevention of freezing of circulating fluid**

This thermo chiller may break down if the circulating fluid freezes, like in the winter time.

When operation of the thermo chiller is stopped, take preventative measures against the freezing of the circulating fluid, such as removing the circulating fluid from the thermo chiller.

⚠ WARNING



- Use caution not to allow the circulating fluid to freeze due to the influence of the ambient environment. Freezing of the circulating fluid may cause a break down of the thermo chiller.

7.3 Consumables

Replace the following parts depending on their condition.

Table 7-3 Consumables

Part number	Name	Qty.	Remarks
HRS-S0001	Dustproof filter	1	For spare

7.4 Stop for a Long Time

If there is a concern that the product will not be operated for a long period of time or there is a risk of freezing, conduct the following operations.

1. Turn off the user's power supply.

2. Drain the circulating fluid of the product completely.
Please refer to "7.4.1 Discharge of the circulating fluid" for the method of drain the circulating fluid from the product.

3. After draining, cover the product with vinyl, etc. and store.

7.4.1 Discharge of the circulating fluid

⚠ WARNING



- Stop the customer device and release the residual pressure before discharging the circulating fluid.

1. Place a container underneath the drain outlet.
(The capacity of the container should be approx. 10L.)

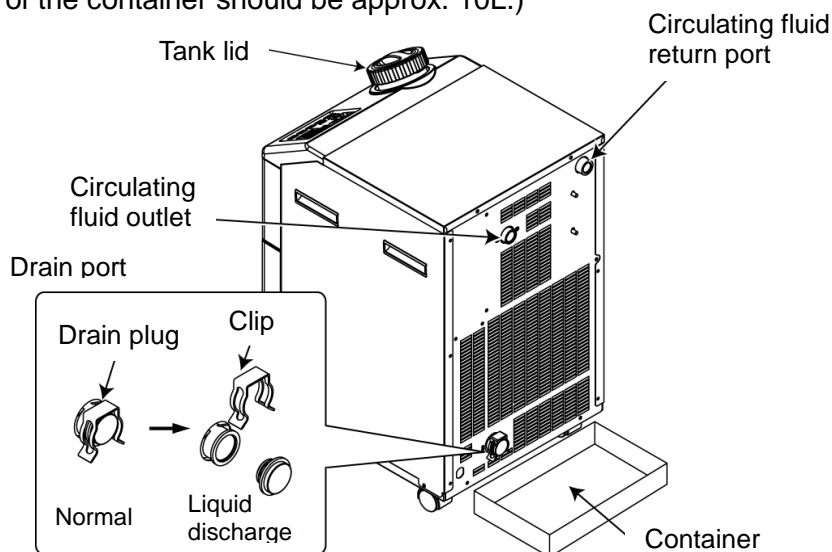

Fig 7.4-1 Drain the circulating fluid and facility water from the product

2. Remove the tank lid.
3. Remove the drain plug on the drain port on the piping to discharge the fluid.
An O ring is used for the drain plug. Take care not to damage the O ring.
4. Confirm that a sufficient amount of the circulating fluid has been drained from the user's machine and piping, and apply air purge from the circulating fluid return port.
5. After discharging the circulating fluid in the tank, refit the drain plug, clip and close the tank lid.
6. Refer to "7.4-2 Plug to the piping of the product" to mount the plug (Rc1/2) to the piping of the product.

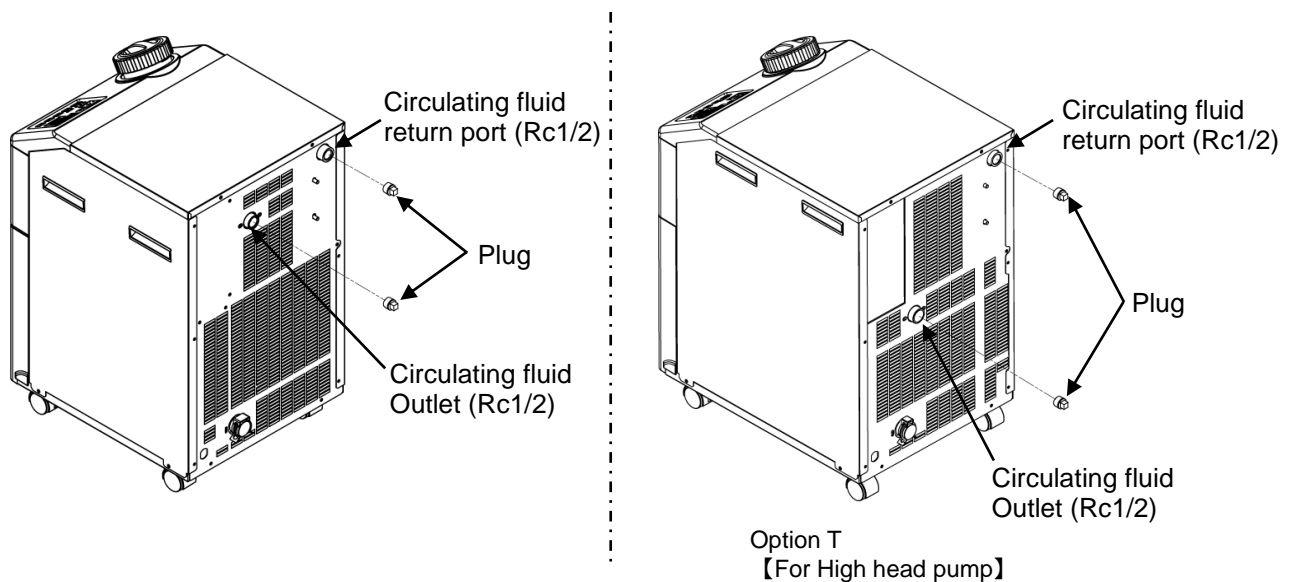

Fig. 7.4-2 Plug to the piping of the product

■ **Fitting for the drain port (Accessory)**

The thermo-chiller includes the fitting for the drain port shown in Fig 7.4-3 .

Discharging of the drain will be easier if customer prepares a valve.

The valve has to be connected to the drain port fitting.

If the valve is connected far away from the drain port fitting, it cause an air trap.

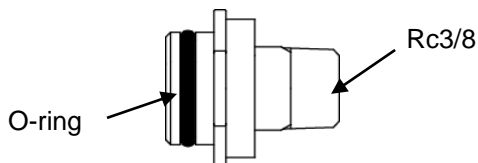

Fig 7.4-3 Fitting for the drain port (Accessories)

Example)

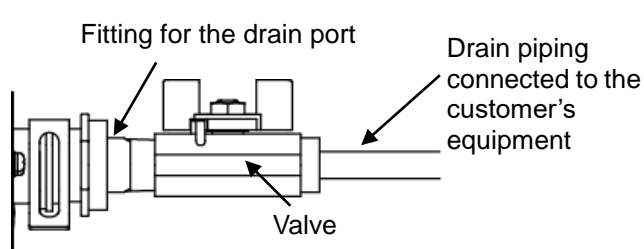

Fig 7.4-4 Example of using fitting for the drain port

Chapter 8 Documents

8.1 Specifications List

8.1.1 Product specification

Table 8-1 Specifications List [HRSE*****-10-(T)]

Model		HRSE012-A-10-(T)	HRSE018-A-10-(T)
Cooling method		Air-Cooled refrigerated type	
Refrigerant		R407C(HFC)	
Quantity of refrigerant	kg	0.3	0.32
Control method		Compressor ON/OFF	
Ambient temperature and humidity*1		Temperature: 5 to 35 °C , Humidity: 30 to 70%	
Circulating fluid system	Circulating fluid*2	Tap water, Ethylene glycol aqueous solution 15%	
	Operating temperature range*1	10 to 30	
	Cooling capacity*3 (50/60Hz)	1000/1200	1400/1600
	Temperature stability*4	±2	
	Pump capacity*5 (50/60Hz)	0.08(at 7L/min) / 0.11(at 7L/min) For option T : 0.13(at 7L/min) / 0.18(at 7L/min)	
	Rated flow*6 (50/60Hz)	7/7	
	Tank capacity	Approx. 5	
	Port size	Rc1/2	
Wetted material		Stainless steel, Copper brazing (Heat exchanger), Bronze, Brass, Ceramic, Carbon, PP, PE, POM, EPDM,PVC	
Electric system	Power supply	1-phase AC100V 50/60Hz. Allowable voltage range ±10%	
	Fuse	15	
	Power supply cable diameter *10	3 cores x 14 AWG (2.0 mm ²), 3m	
	Applicable earth leakage breaker capacity*7	15	
	Rated operating current *3 (50/60Hz)	7.1/7.8 For option T : 7.8/8.4	7.1/7.8 For option T : 7.8/8.4
	Rated power consumption *3 (50/60Hz)	0.53/0.54 For option T : 0.62/0.62	0.63/0.63 For option T : 0.72/0.72
Dimensions *8	mm	W377xD435xH615 For option T : W377xD500xH615	
Accessory		Fitting (for drain port) 1pc. Operation manual (Installation·Operation (Japanese)) 1pc.	
Weight*9	kg	32	For option T : 39

*1 Use the product in conditions where freezing will not occur.

Consult with SMC if using in a season or region where the ambient temperature will fall below zero.

*2 If tap water is used, use water which satisfies the standard of The Japan Refrigeration And Air Conditioning Industry Association (JRA GL-02-1994/Cooling water system - circulation type - make-up water)

*3 (1)Operating ambient temp.: 25°C, (2)Circulating fluid temp.: 20°C, (3)Circulating fluid rated flow, (4)Circulating fluid : Tap water
The cooling capacity will be reduced by 100W when option T [High head pump] are selected.

*4 Outlet temp. when the circulating fluid flow is rated flow, and the circulating fluid outlet and the return are directly connected.

Installation environment and power supply are within specification range and stable.

*5 The capacity at the thermo-chiller outlet when the circulating fluid temp. is 20°C.

*6 Fluid flow to maintain the cooling capacity and the temperature stability.

The specification of the cooling capacity and the temperature stability may not be satisfied if the flow rate is lower than the rated flow.

*7 To be prepared by the customer. Use an earth leakage breaker with sensitivity of 15mA or 30mA/100V in power supply specification

*8 Dimension between panels. Projection is not included.

*9 Weight when the circulating fluid is not included.

*10: Cable is provided with a plug with ground terminal (JIS C8303 Plug for the receptacle with dipole grounding electrodes).

Table 8-2 Specifications List[HRSE***-A-20-(T)]

Model		HRSE012-A-20-(T)	HRSE018-A-20-(T)	HRSE024-A-20-(T)	
Cooling method		Air-Cooled refrigerated type			
Refrigerant		R407C(HFC)			
Quantity of refrigerant	kg	0.32	0.33	0.34	
Control method		Compressor ON/OFF			
Ambient temperature and humidity*1		Temperature: 5 to 40 °C , Humidity: 30 to 70%			
Circulating fluid system	Circulating fluid*2		Tap water, Ethylene glycol aqueous solution 15%		
	Operating temperature range*1	°C	10 to 30		
	Cooling capacity*3(50/60Hz)	W	1000/1200	1400/1600	1900/2200
	Temperature stability*4	°C	±2		
	Pump capacity*5 (50/60Hz)	MPa	0.08(at 7L/min)/0.11(at 7L/min) For option T : 0.13(at 7L/min)/0.18(at 7L/min)		
	Rated flow*6 (50/60Hz)	L/min	7/7		
	Tank capacity	L	Approx. 5		
	Port size		Rc1/2		
Wetted material		Stainless steel, Copper brazing (Heat exchanger), Bronze, Brass, Ceramic, Carbon, PP, PE, POM, EPDM,PVC			
Electric system	Power supply		1-phase AC200V 50/60Hz. Allowable voltage range ±10%		
	Fuse	A	15		
	Power supply cable diameter *10	-	3 cores x 14 AWG (2.0 mm ²), 3m		
	Applicable earth leakage breaker capacity*7	A	15		
	Rated operating current*3 (50/60Hz)	A	4.1/5.0 For option T : 4.5/5.4	4.2/5.3 For option T : 4.6/5.7	4.3/5.4 For option T : 4.7/5.8
Rated power consumption*3 (50/60Hz)	kVA	0.58/0.74 For option T : 0.66/0.82	0.73/0.86 For option T : 0.81/0.94	0.85/1.02 For option T : 0.93/1.10	
Dimensions*8	mm	W377xD435xH615 For option T : W377xD500xH615			
Accessory		Fitting (for drain port) 1pc. Operation manual (Installation·Operation (Japanese)) 1pc.			
Weight*9	kg	35 For option T : 42			

*1 Use the product in conditions where freezing will not occur.

Consult with SMC if using in a season or region where the ambient temperature will fall below zero.

*2 If tap water is used, use water which satisfies the standard of The Japan Refrigeration And Air Conditioning Industry Association (JRA GL-02-1994/Cooling water system - circulation type - make-up water)

*3 (1)Operating ambient temp.: 25°C, (2)Circulating fluid temp.: 20°C, (3)Circulating fluid rated flow, (4)Circulating fluid : Tap water
The cooling capacity will be reduced by 100W when option T [High head pump] are selected.

*4 Outlet temp. when the circulating fluid flow is rated flow, and the circulating fluid outlet and the return are directly connected.
Installation environment and power supply are within specification range and stable.

*5 The capacity at the thermo-chiller outlet when the circulating fluid temp. is 20°C.

*6 Fluid flow to maintain the cooling capacity and the temperature stability.

The specification of the cooling capacity and the temperature stability may not be satisfied if the flow rate is lower than the rated flow.

*7 To be prepared by the customer. Use an earth leakage breaker with sensitivity of 30mA/200V in power supply specification

*8 Dimension between panels. Projection is not included.

*9 Weight when the circulating fluid is not included.

*10: The end parts of all three lead wires of the cable are untreated (bare cut).

Table 8-3 Specifications List[HRSE***-A-23-(T)]

Model		HRSE012-A-23-(T)	HRSE018-A-23-(T)	HRSE024-A-23-(T)	
Cooling method		Air-Cooled refrigerated type			
Refrigerant		R407C(HFC)			
Quantity of refrigerant	kg	0.32	0.33	0.34	
Control method		Compressor ON/OFF			
Ambient temperature and humidity*1		Temperature: 5 to 40°C , Humidity: 30 to 70%			
Circulating fluid system	Circulating fluid*2		Tap water, Ethylene glycol aqueous solution 15%		
	Operating temperature range*1	°C	10 to 30		
	Cooling capacity*3 (50/60Hz)	W	1000/1200	1400/1600	1900/2200
	Temperature stability*4	°C	±2		
	Pump capacity*5 (50/60Hz)	MPa	0.08(at 7L/min)/0.11(at 7L/min) For option T : 0.13(at 7L/min)/0.18(at 7L/min)		
	Rated flow*6 (50/60Hz)	L/min	7/7		
	Tank capacity	L	Approx. 5		
	Port size		Rc1/2		
Wetted material		Stainless steel, Copper brazing (Heat exchanger), Bronze, Brass, Ceramic, Carbon, PP, PE, POM, EPDM,PVC			
Electric system	Power supply		1-phase AC230V 50/60Hz. Allowable voltage range ±10%		
	Fuse	A	15		
	Power supply cable diameter*10	-	3 cores x 14 AWG (2.0 mm ²), 3m		
	Applicable earth leakage breaker capacity*7	A	15		
	Rated operating current*3 (50/60Hz)	A	4.1/5.0 For option T : 4.5/5.4	4.2/5.3 For option T : 4.6/5.7	4.3/5.4 For option T : 4.7/5.8
	Rated power consumption*3 (50/60Hz)	kVA	0.58/0.74 For option T : 0.66/0.82	0.73/0.86 For option T : 0.81/0.94	0.87/1.04 For option T : 0.93/1.10
Dimensions*8	mm	W377xD435xH615 For option T : W377xD500xH615			
Accessory		Fitting (for drain port) 1pc. Operation manual (Installation·Operation (English)) 1pc.			
Weight*9	kg	35 For option T : 42			
Standard	CE Mark	EMC Directive	2004/108/EC		
		Machinery Directive	2006/42/EC		

*1 Use the product in conditions where freezing will not occur.

Consult with SMC if using in a season or region where the ambient temperature will fall below zero.

*2 If tap water is used, use water which satisfies the standard of The Japan Refrigeration And Air Conditioning Industry Association (JRA GL-02-1994/Cooling water system - circulation type - make-up water)

*3 (1)Operating ambient temp.: 25°C, (2)Circulating fluid temp.: 20°C, (3)Circulating fluid rated flow, (4)Circulating fluid : Tap water
The cooling capacity will be reduced by 100W when option T [High head pump] are selected.

*4 Outlet temp. when the circulating fluid flow is rated flow, and the circulating fluid outlet and the return are directly connected.
Installation environment and power supply are within specification range and stable.

*5 The capacity at the thermo-chiller outlet when the circulating fluid temp. is 20°C.

*6 Fluid flow to maintain the cooling capacity and the temperature stability.

The specification of the cooling capacity and the temperature stability may not be satisfied if the flow rate is lower than the rated flow.

*7 To be prepared by the customer. Use an earth leakage breaker with sensitivity of 30mA/230V in power supply specification

*8 Dimension between panels. Projection is not included.

*9 Weight when the circulating fluid is not included.

*10: The end parts of all three lead wires of the cable are untreated (bare cut).

8.1.2 Refrigerant with GWP reference

Table8-4 Refrigerant with GWP reference

Refrigerant	Global Warming Potential (GWP)	
	Regulation (EU) No 517/2014 (Based on the IPCC AR4)	Revised Fluorocarbons Recovery and Destruction Law (Japanese law)
R134a	1,430	1,430
R404A	3,922	3,920
R407C	1,774	1,770
R410A	2,088	2,090

Note:

1. This product is hermetically sealed and contains fluorinated greenhouse gases.
2. See specification table for refrigerant used in the product.

8.2 Outline dimensions

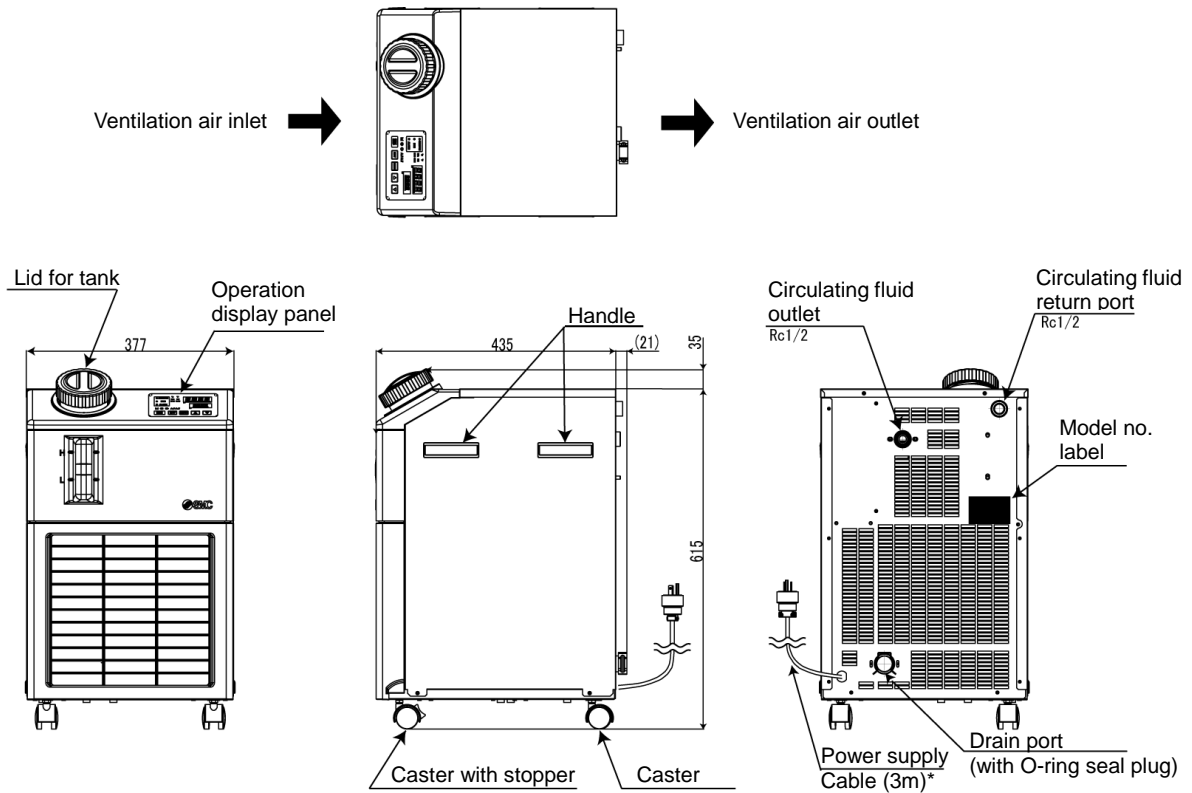

Fig. 8.2-1 Outline dimensions

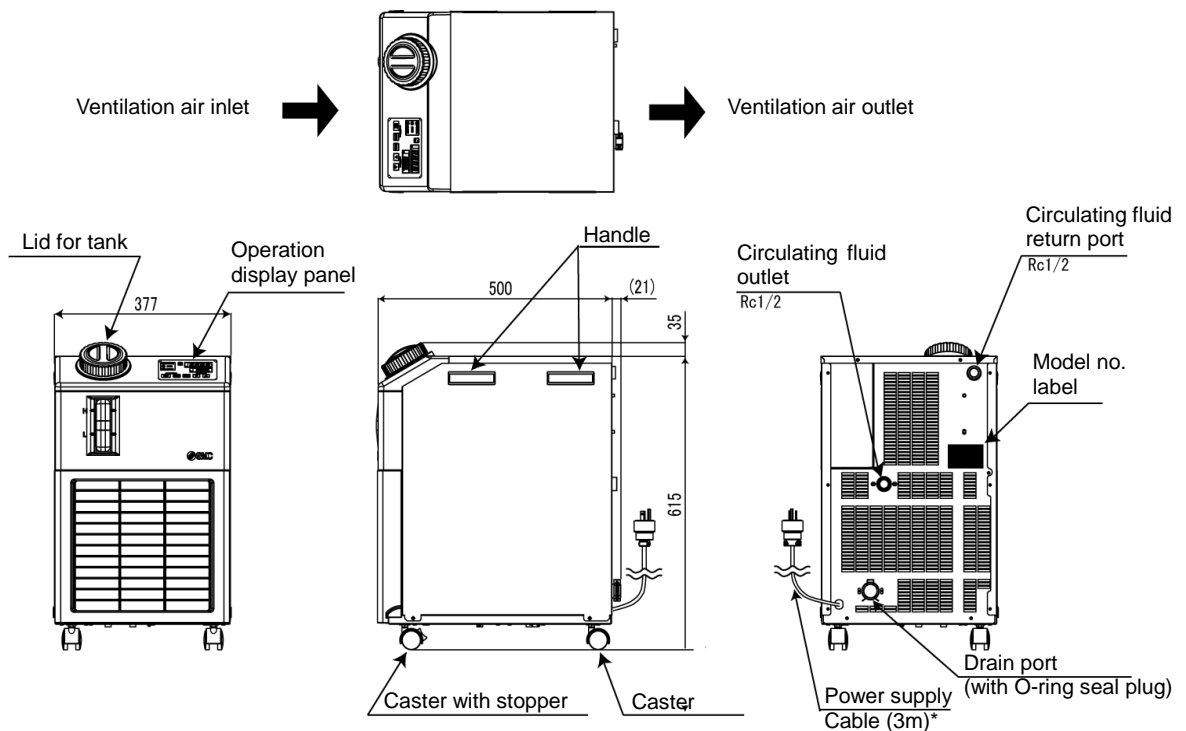

Fig. 8.2-2 Outline dimensions

* Power supply cable terminal configuration

- 100V power supply specification: Cable is provided with a plug with ground terminal (JIS C8303 Plug for the receptacle with dipole grounding electrodes).
- 200/230V power supply specification: The end part of all three lead wires are untreated (bare cut).

8.3 Flow chart

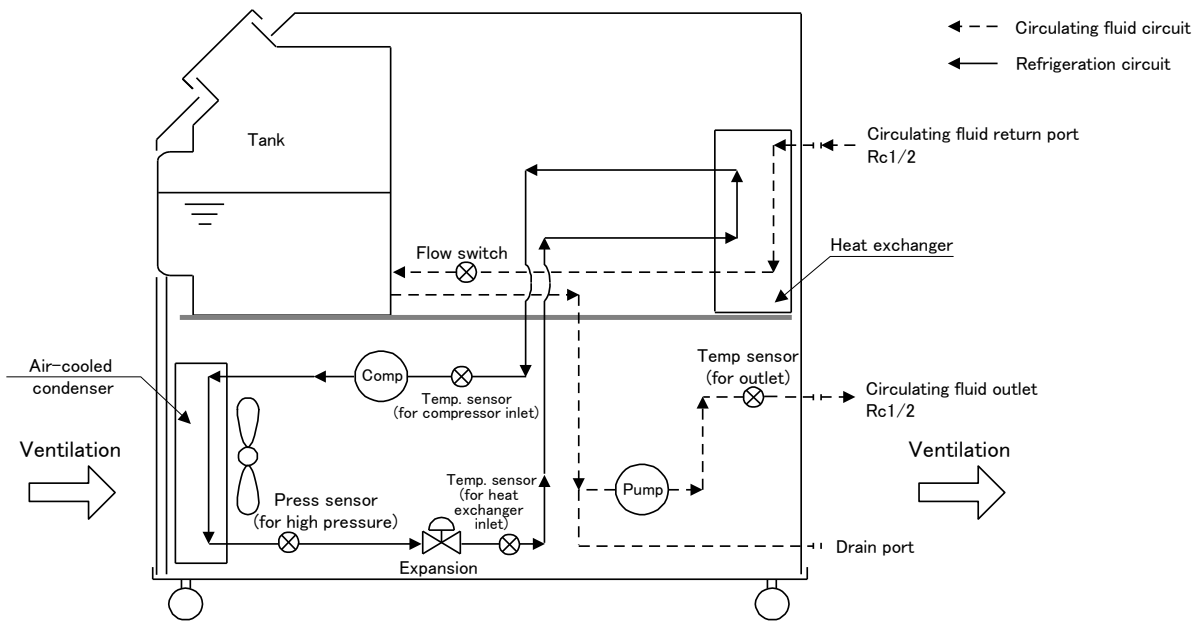
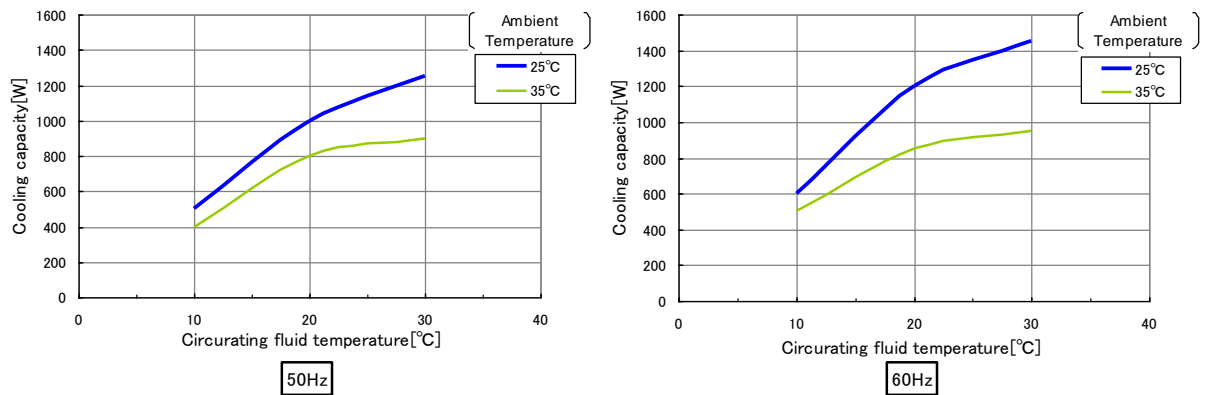

Fig. 8.3-1 Flow chart (HRSE012/018/024-A-10/20/23-(T))

8.4 Cooling capacity

8.4.1 HRSE012-A-10-(T)



*The cooling capacity will be reduced by 100W when option: -T is selected.

Fig. 8.4-1 Cooling capacity(HRSE012-A-10)

8.4.2 HRSE018-A-10-(T)

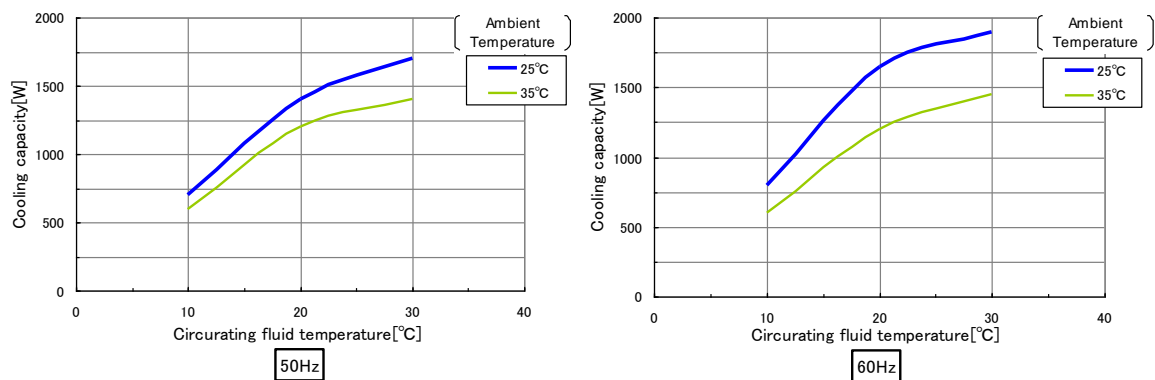

*The cooling capacity will be reduced by 100W when option: -T is selected.

Fig. 8.4-2 Cooling capacity(HRSE018-A-10)

8.4.3 HRSE012-A-20/23-(T)

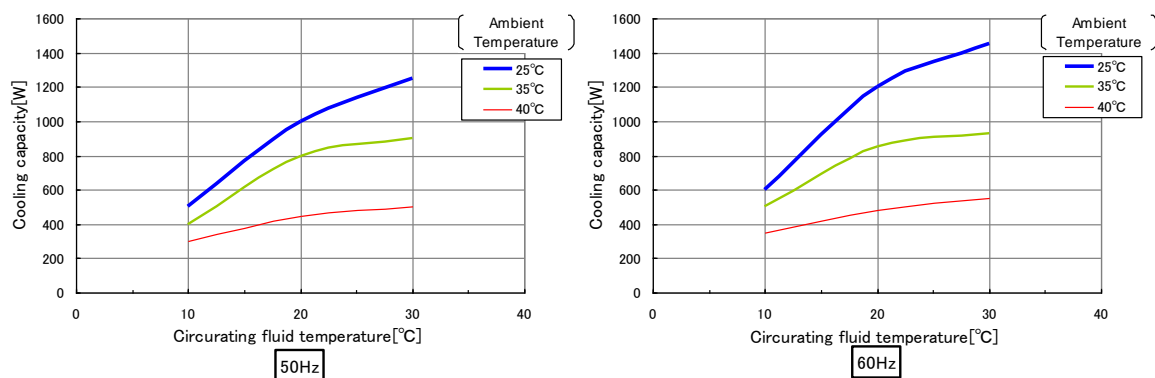

*The cooling capacity will be reduced by 100W when option: -T is selected.

Fig. 8.4-3 Cooling capacity(HRSE012-A-20/23)

8.4.4 HRSE018-A-20/23-(T)

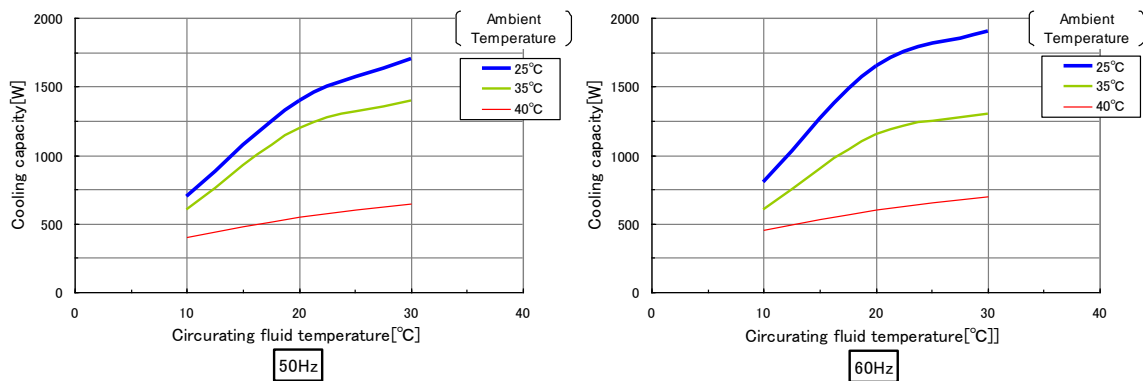

*The cooling capacity will be reduced by 100W when option: -T is selected.

Fig. 8.4-4 Cooling capacity(HRSE018-A-20/23)

8.4.5 HRSE024-A-20/23-(T)

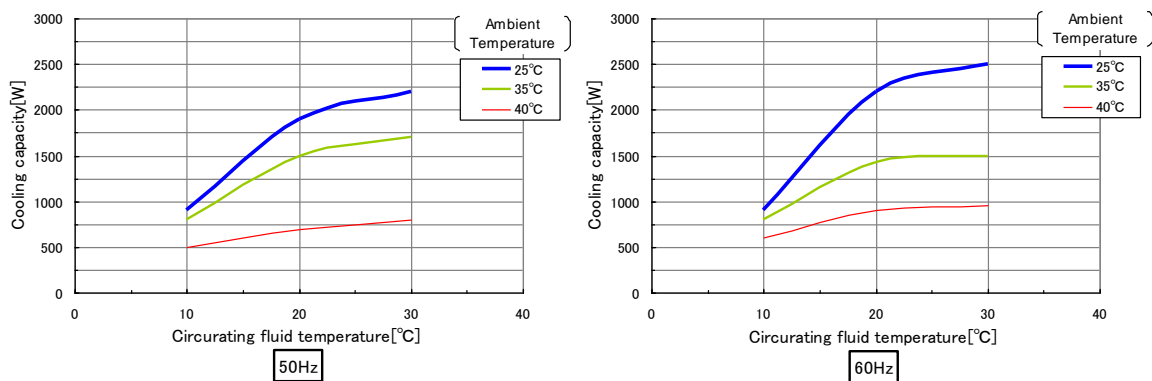

*The cooling capacity will be reduced by 100W when option: -T is selected.

Fig. 8.4-5 Cooling capacity(HRSE024-A-20/23)

8.5 Pump capacity

8.5.1 HRSE012/018-A-10

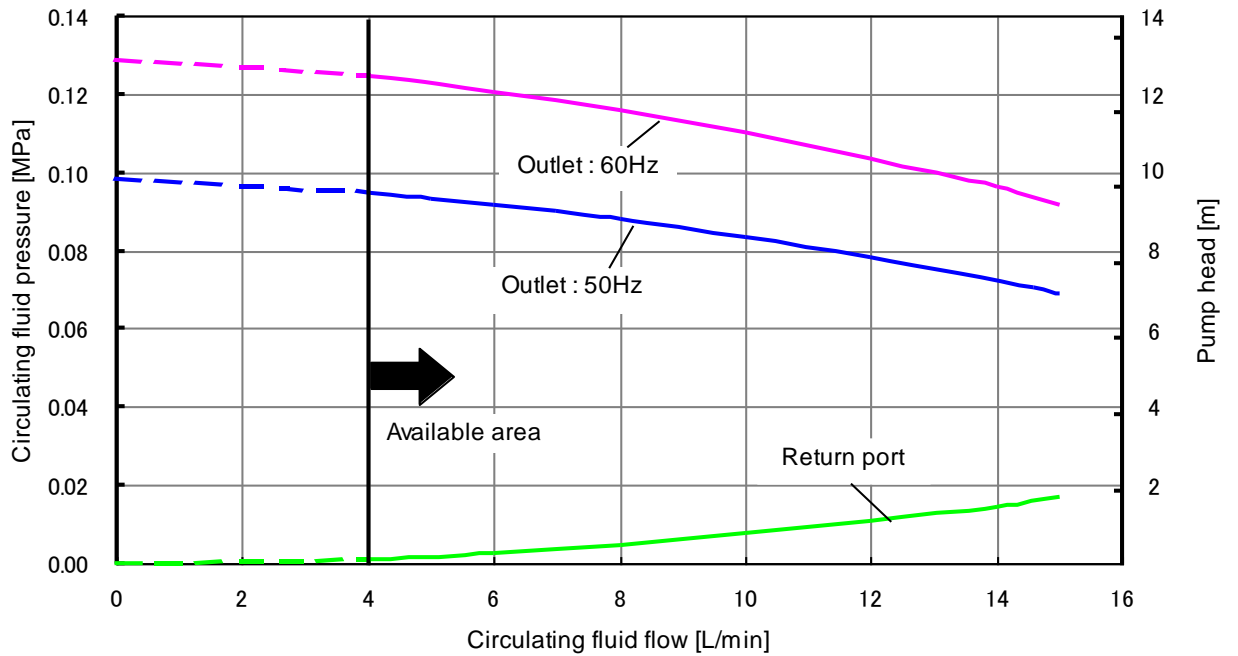

Fig. 8.5-1 Pump capacity (HRSE012-A-10, HRSE018-A-10)

8.5.2 HRSE012/018/024-A-20/23

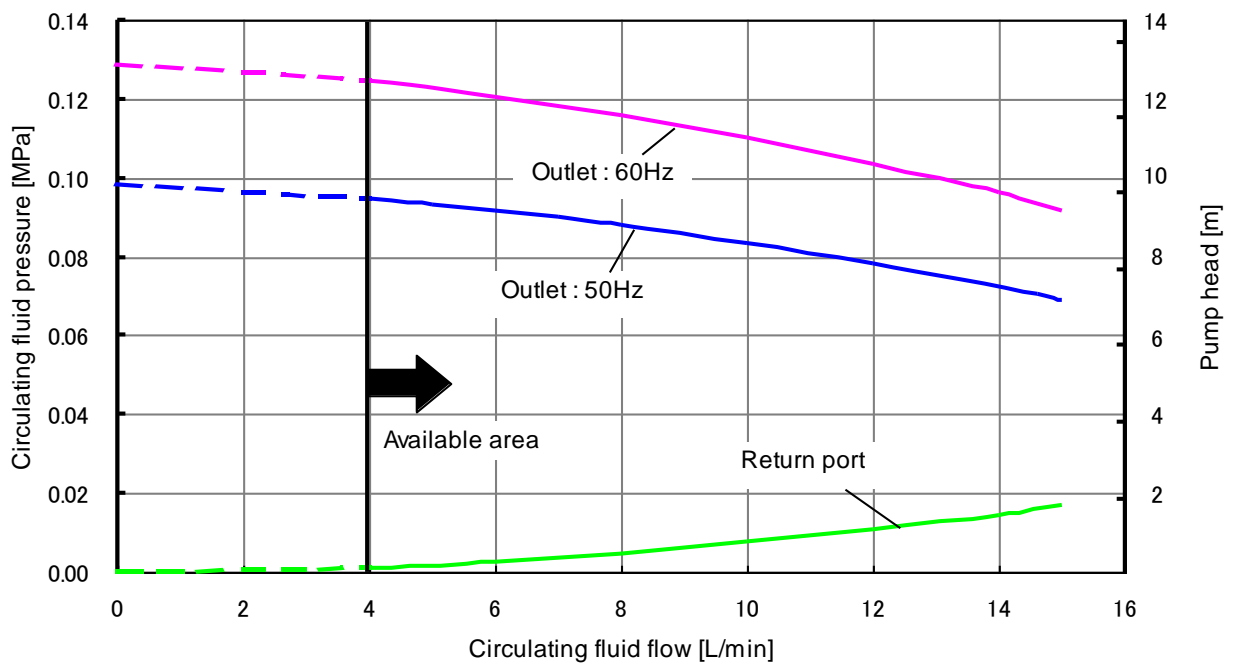

Fig. 8.5-2 Pump capacity (HRSE012-A-20/23, HRSE018-A-20/23, HRSE024-A-20/23)

8.5.3 OPTION-T (HRSE012/018-A-10-T)

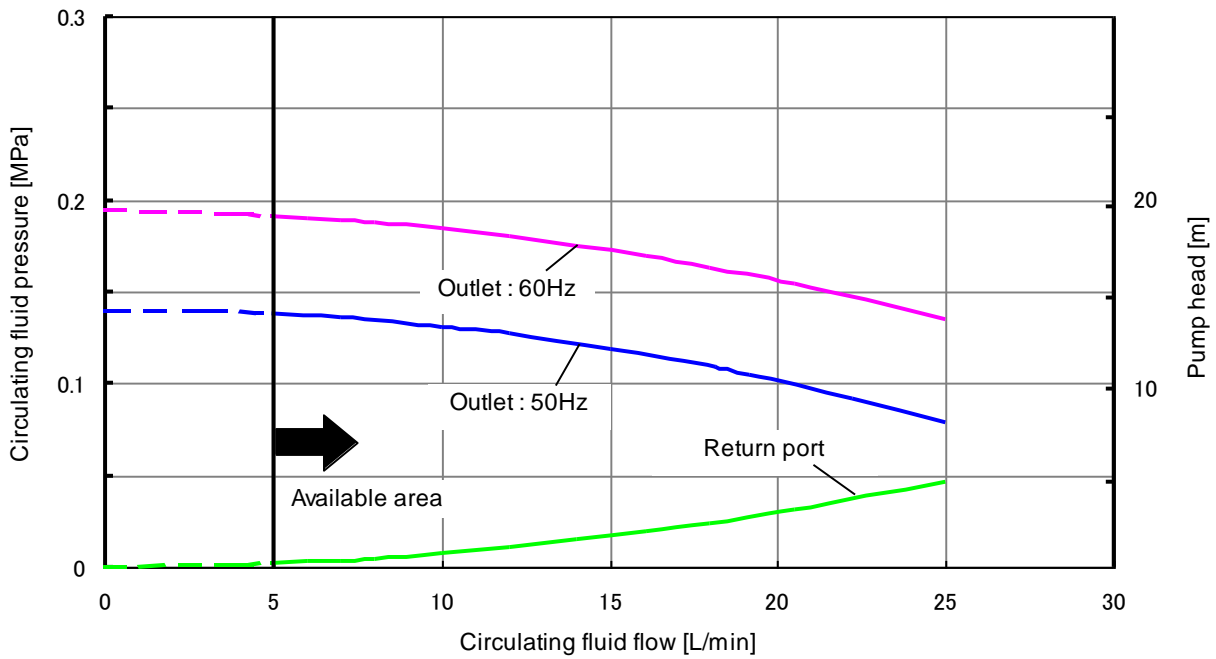

Fig. 8.5-3 Pump capacity (HRSE012-A-10-T, HRSE018-A-10-T)

8.5.4 OPTION-T (HRSE012/018/024-A-20/23-T)

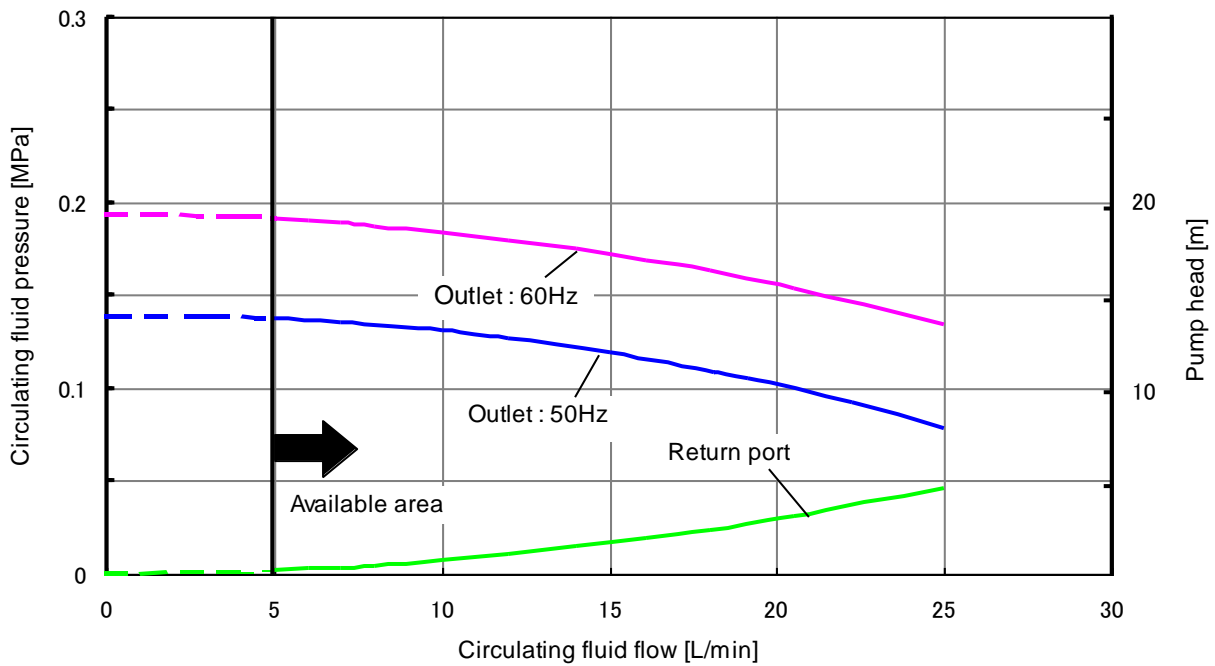

Fig. 8.5-4 Pump capacity (HRSE012-A-20/23-T, HRSE018-A-20/23-T, HRSE024-A-20/23-T)

8.6 Sample DoC. (Power supply “-23” only)



Sample DoC.

EC DECLARATION OF CONFORMITY

Original declaration

SMC Corporation
4-14-1 Soto-Kanda, Chiyoda-ku, Tokyo 101-0021 Japan

declares under our sole responsibility that the following equipment:

Thermo Chiller
HRSE Series
Serial No.: *o001 to *Z999

conforms with the following directive(s) and harmonized standards:

Directive	Harmonized standards
Machinery Directive 2006/42/EC	EN ISO12100:2010 EN60204-1:2006+A1:2009
EMC Directive 2004/108/EC	EN61000-6-2:2005 EN55011:2009+A1:2010

Name and address of the person authorised to compile the technical file:

Mr. G. Berakoetxea, Director & General Manager, SMC European Zone,
SMC España, S.A., Zuazobidea 14, 01015 Vitoria, Spain

Importer/Distributor in EU and EFTA:

Country	Company	Telephone	Address
Austria	SMC Pneumatik GmbH (Austria)	(43) 2262-62280-0	Girakstrasse 8, AT-2100 Korneuburg
Belgium	SMC Pneumatics N.V./S.A.	(32) 3-355-1464	Nijverheidsstraat 20, B-2160 Wommelgem
Bulgaria	SMC Industrial Automation Bulgaria EOOD	(359) 2 9744492	Business Park Sofia, Building 8-6th Floor, BG-1715 Sofia
Czech Republic	SMC Industrial Automation CZ s.r.o.	(420) 541-426-611	Hudcova 78a CZ-61200 Brno
Denmark	SMC Pneumatik A/S	(45) 70 25 29 00	Egeskovvej 1, DK-8700 Horsens
Estonia	SMC Pneumatics Estonia OU	(372)651-0370	Laki 12, EE-10621 Tallinn
Finland	SMC Pneumatikka Finland Oy	(358) 20 7513 513	PL72, Tiistinniityntie 4, SF-02231 Espoo
France	SMC Pneumatique S.A.	(33) 1-6476-1000	1 Boulevard de Strasbourg, Parc Gustave Eiffel, Bussy Saint Georges, F-77600
Germany	SMC Pneumatik GmbH	(49) 6103-402-0	Boschring 13-15, D-63329 Egelsbach
Greece	SMC Hellas E.P.E	(30) 210-2717265	Anagenniseos 7-9 - P.C. 14342, Nea Philadelphia, Athens
Hungary	SMC Hungary Ipari Automatizálási Kft.	(36) 23-511-390	Torbágy u. 19, HU-2045 Törökbálint
Ireland	SMC Pneumatics (Ireland) Ltd.	(353) 1-403-9000	2002 Citywest Business Campus, Naas Road, Saggart, Co. Dublin
Italy	SMC Italia S.p.A.	(39) 02-9271-1	Via Garibaldi, 62, I-20061 Carugate, Milano
Latvia	SMC Pneumatics Latvia SIA	(371)781-77-00	Šmerļa ielā, 1-705, Rīga LV-1006
Lithuania	SMC Pneumatics Lietuva, UAB	(370)5-264-81-26	Oslo g.1, LT-04123 Vilnius
Netherlands	SMC Pneumatics B.V.	(31) 20-531-8888	De Ruyterkade 120, NL-1011 AB Amsterdam
Norway	SMC Pneumatics Norway AS	(47) 67-12-90-20	Vollsveien 13c, Granfoss Næringspark, N-1366 Lysaker
Poland	SMC Industrial Automation Polska Sp. zo.o	(48) 22 211 96 00	ul. Poloneza 89, PL-02-826 Warszawa
Portugal	SMC Sucursal Portugal, S.A.	(351) 22 616 6570	Rua De Eng Ferrerira Dias 452 4100-246, Porto
Romania	SMC Romania S.r.l.	(40)21-3205111	Str. Frunzei, Nr.29, Sector 2 Bucharest, Romania
Slovakia	SMC Priemyselna Automatizacia, s.r.o.	(421) 2-444 56 725	Námestie Matina Benku, 10, 81107 Bratislava
Slovenia	SMC Industrijska Avtomatika d.o.o.	(386) 7388 5412	Mirnska cesta 7, SLO-8210 Trebnje
Spain	SMC España, S.A.	(34) 945-184-100	Zuazobidea 14, 01015 Vitoria
Sweden	SMC Pneumatics Sweden AB	(46) 8-603-12-00	Ekhagsvägen 29-31, SE-14171 Segeltorp
Switzerland	SMC Pneumatik AG	(41) 52-396-3131	Dorfstrasse 7, Postfach 117 CH-8484, Weisslingen
United Kingdom	SMC Pneumatics (U.K.) Ltd.	(44) 1908-563888	Vincent Avenue, Crownhill, Milton Keynes, Bucks MK8 0AN

Tokyo, * th January 20 * *

Iwao Mogi

Director & General Manager
Product Development Division - VI

8.7 Daily Check Sheet



Thermo-chiller Daily Check Sheet

For information about how to perform daily checks of the thermo chiller, refer to section "8.2.1 Daily Check" of the operation manual.
Check and record the condition at start right after setting up.

Model no. _____
Mfg. code _____

Date	Performed by	Setting up conditions		Fluid leakage	Fluid amount	Operation panel		Circulating fluid temp	Operation conditions		Result
		Temperature °C	Humidity %			Present/ Not present	Inside/Outside of liquid level indicator Inside/Outside		Display	Operation	
Right after setting up (initial value)											

Chapter 9 Product Warranty

1. Period

The warranty period of the product is 1 year in service or 1.5 years after the product is delivered, whichever is first.

2. Scope

For any failure reported within the warranty period which is clearly our responsibility, replacement parts will be provided. In that case, removed parts shall become the property of SMC. This guarantee applies only to our product independently, and not to any other damage incurred due to the failure of the product.

3. Content

1. We guarantee that the product will operate normally if it is installed under maintenance and control in accordance with the Operation Manual, and operated under the conditions specified in the catalog or contracted separately.
2. We guarantee that the product does not have any defects in components, materials or assembly.
3. We guarantee that the product complies with the outline dimensions provided.
4. The following situations are out of scope of this warranty.
 - (1) The product was incorrectly installed or connected with other equipment.
 - (2) The product was under insufficient maintenance and control or incorrectly handled.
 - (3) The product was operated outside of the specifications.
 - (4) The product was modified or altered in construction.
 - (5) The failure was a secondary failure of the product caused by the failure of equipment connected to the product.
 - (6) The failure was caused by a natural disaster such as an earthquake, typhoon, or flood, or by an accident or fire.
 - (7) The failure was caused by operation different from that shown in the Operation Manual or outside of the specifications.
 - (8) The checks and maintenance specified (daily checks and regular checks) were not performed.
 - (9) The failure was caused by the use of circulating fluid or facility water other than those specified.
 - (10) The failure occurred naturally over time (such as discoloration of a painted or plated face).
 - (11) The failure does not affect the functioning of the product (such as new sounds, noises and vibrations).
 - (12) The failure was due to the "Installation Environment" specified in the Operation Manual.
 - (13) The failure was caused by the customer disregarding "6. Request to customers".

4. Agreement

If there is any doubt about anything specified in "2. Scope" and "3. Content", it shall be resolved by agreement between the customer and SMC.

5. Disclaimer

- (1) Expenses for daily and regular checks
- (2) Expenses for repairs performed by other companies
- (3) Expenses for transfer, installation and removal of the product
- (4) Expenses for replacement of parts other than those in this product, or for the supply of liquids
- (5) Inconvenience and loss due to product failure (such as telephone bills, compensation for workplace closure, and commercial losses)
- (6) Expenses and compensation not covered in "2. Scope".

6. Request to customers

Proper use and maintenance are essential to assure safe use of this product. Be sure to satisfy the following preconditions. Please note that we may refuse to carry out warranted repair if these preconditions have been disregarded.

- (1) Use the product following the instructions for handling described in the Operation Manual.
- (2) Perform checks and maintenance (daily checks and regular checks) specified in the Operation Manual and Maintenance Manual.
- (3) Record the check and maintenance results on the daily check sheet attached to the Operation Manual and Maintenance Manual.

7. Request for Warranted Repair

For warranted repair, please contact the supplier you purchased this product from. Warranted repair shall be on a request basis.

Repair shall be provided free of charge in accordance with the warranty period, preconditions and terms defined above. Therefore, a fee will be charged for any repairs if a failure is detected after the end of the warranty period.

Revision
Rev J : Dec.2021

SMC Corporation

4-14-1, Sotokanda, Chiyoda-ku, Tokyo 101-0021 JAPAN

Tel: + 81 3 5207 8249 Fax: +81 3 5298 5362

URL <https://www.smcworld.com>

Note: Specifications are subject to change without prior notice and any obligation on the part of the manufacturer.

© 2021 SMC Corporation All Rights Reserved