



# Operation Manual

## Communication function

### Thermo-chiller

**Air-Cooled refrigerated type**

*HRL100-A-20/40*

*HRL200-A-20/40*

*HRL300-A-20/40*

*HRL400-A-40*

**Water-Cooled refrigerated type**

*HRL100-W-40*

*HRL200-W-40*

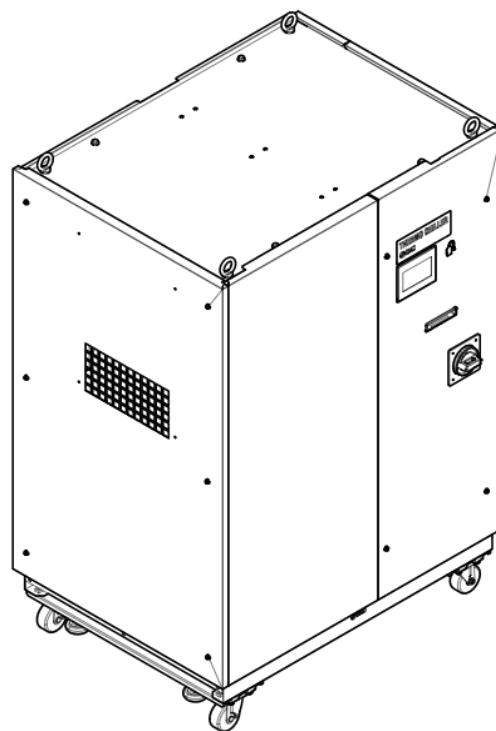
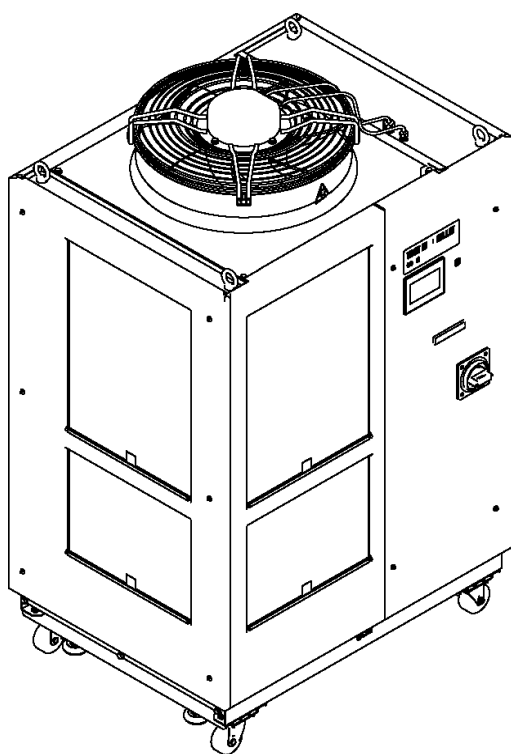

**Keep this manual available whenever necessary**

## To Users,

Thank you for purchasing SMC's Thermo chiller (hereinafter referred to as the "product").

For safety and long life of the product, be sure to read this operation manual (hereinafter referred to as the "manual") and clearly understand the contents.

- Be sure to read and follow all instructions noted with "Warning" or "Caution" in this manual.
- This manual is intended to explain the installation and operation of the product. Only people who understand the basic operation of the product through this manual or who performs installation and operation of or have basic knowledge about industrial machines are allowed to work on the product.
- This manual and other documents do not constitute a contract, and will not affect any existing agreements or commitments.
- It is strictly prohibited to copy this manual entirely or partially for the use by the third party without prior permission from SMC.

**Note: This manual is subject to possible change without prior notice.**

# Contents

<b>Chapter 1</b>	<b>Read before using</b> .....	<b>1-1</b>
1.1	Operation mode and operation method.....	1-2
1.2	Change of operation mode .....	1-3
1.3	Communication port .....	1-5
1.4	Touch panel flow .....	1-6
<b>Chapter 2</b>	<b>Contact input/output communication/Analog output communication</b> .....	<b>2-1</b>
2.1	Precautions for communication .....	2-1
2.1.1	Precautions wiring communication .....	2-1
2.1.2	Precautions after wiring and before communication .....	2-2
2.2	Communication specification.....	2-2
2.3	Contact input signal.....	2-5
2.3.1	Setting of contact input signal type and form .....	2-5
2.3.2	Run/stop·Run·Stop·External switch signal.....	2-7
2.3.3	External switch signal.....	2-8
2.4	Contact output signal.....	2-10
2.4.1	Contact output signal 1 to 3 .....	2-10
2.4.2	Contact output signal 4 to 6 .....	2-11
2.5	Analog output signal.....	2-14
<b>Chapter 3</b>	<b>Serial communication</b> .....	<b>3-1</b>
3.1	Precautions wiring communication .....	3-1
3.2	Connected explanation .....	3-1
3.3	Communication specification.....	3-2
3.4	Modbus communication function .....	3-3
3.5	Precautions for communication .....	3-4
3.5.1	Precautions after wiring and before communication .....	3-4
3.5.2	Precautions for communicating.....	3-4
3.6	Setting method .....	3-5
3.7	Communication sequence .....	3-7
3.8	Message configuration .....	3-7
3.8.1	Message frame.....	3-7
3.9	Function codes.....	3-9
3.10	Checksum calculation method.....	3-9
3.10.1	LRC(ASCII) .....	3-9
3.10.2	CRC(RTU).....	3-10
3.11	Explanation of function codes .....	3-12
3.11.1	Function code:04 Reading multiple registers .....	3-12
3.11.2	Function code:06 Writing registers.....	3-14
3.11.3	Function code:16 Writing multiple registers .....	3-15
3.12	Negative response .....	3-16
3.13	Register Map.....	3-18

---

3.13.1	Circulating fluid discharge temperature .....	3-19
3.13.2	Circulating fluid electrical conductivity .....	3-19
3.13.3	Circulating fluid discharge pressur .....	3-19
3.13.4	Circulating fluid flow rate .....	3-19
3.13.5	Status flag.....	3-20
3.13.6	Alarm flag.....	3-21
3.13.7	Data display .....	3-22
3.13.8	Circulating fluid set temperature.....	3-22
3.13.9	Operation instruction .....	3-23
3.13.10	Data instruction.....	3-23
<b>Chapter 4</b>	<b>Communication alarm function .....</b>	<b>4-1</b>
4.1	Communication alarm occurs.....	4-1
4.2	Communication alarm reset.....	4-2
4.3	Setting method.....	4-2
<b>Chapter 5</b>	<b>Ethernet Modbus / TCP communication.....</b>	<b>5-1</b>
5.1	Request for taking measures for information security .....	5-1
5.2	Precautions for wiring communication .....	5-2
5.3	Connected explanation.....	5-2
5.4	Communication specification .....	5-3
5.5	Modbus/TCP communication function .....	5-3
5.6	Precautions for communication.....	5-4
5.6.1	Precautions after wiring and before communication .....	5-4
5.6.2	Precautions for communicating .....	5-4
5.7	Setting method.....	5-5
5.7.1	IP Address Setting .....	5-6
5.7.2	Setting of subnet mask and default gateway.....	5-7
5.8	Communication sequence.....	5-8
5.9	Message configuration .....	5-8
5.10	Function codes .....	5-9
5.11	Explanation of function codes .....	5-10
5.12	Register Map .....	5-11
5.12.1	Circulating fluid discharge temperature .....	5-13
5.12.2	Circulating fluid electrical conductivity .....	5-13
5.12.3	Circulating fluid discharge pressur .....	5-13
5.12.4	Circulating fluid flow rate .....	5-13
5.12.5	Status flag.....	5-13
5.12.6	Alarm flag.....	5-13
5.12.7	Data display .....	5-13
5.12.8	Circulating fluid set temperature.....	5-13
5.12.9	Operation instruction .....	5-14
5.12.10	Data instruction.....	5-15
5.12.11	Product number .....	5-15
5.12.12	Serial number .....	5-17
5.12.13	Control board program number .....	5-17
5.12.14	Control board program version.....	5-17

---

5.12.15 Display program number.....	5-17
5.12.16 Display program version .....	5-17



# Chapter 1 Read before using

The communication of this device consists of contact input/output communication and analog output communication and serial communication, Ethernet Modbus/TCP communication.

- The serial communication protocol is a Modbus communication.
- The Ethernet communication protocol is a Modbus /TCP.

Depending on the customer's specification, communication can be changed to contact input/output communication or serial communication and Ethernet communication.

Table 1-1 Communication method

Contact input/output communication / Analog output communication		This product is equipped with a terminal which runs/stops the product by remote control and a terminal which can pick up alarm signals. The terminals can be changed depending on the customer's application.
Serial communication	Modbus standard Protocol	Serial communication (RS-485/RS232C) enables remote control of run/start of the product, temperature setting, and details of product condition and alarm condition can be obtained.
Ethernet communication	Modbus /TCP standard protocol	Ethernet Modbus/TCP communication enables remote control of run/start of the product, temperature setting, and details of product condition and alarm condition can be obtained.

**●If using contact input/output communication, refer to chapter 2.**

**●If using serial communication Modbus, refer to chapter 3.**

**●If using Ethernet Modbus/TCP communication, refer to chapter 5.**

## 1.1 Operation mode and operation method

LOCAL, DIO and SERIAL are available as the operation modes. Table 1.1-1 explains the operation modes. The default setting is LOCAL.

The operation method depends on the operation mode. Table 1.1-2 shows how the operation mode and method of operation are related.

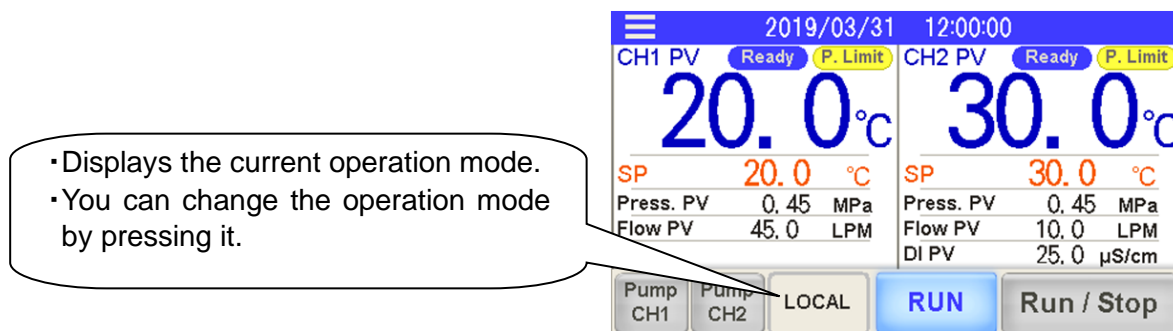

Operation mode display and setting

Table 1.1-1 Operation modes.

Operation mode	Explanation	Contents	Display
LOCAL	Run / stop and circulating fluid temperature setting are possible with the touch panel.	Set the operation mode to "LOCAL".	To display the "LOCAL"
DIO	Run / stop by contact input. Circulating fluid temperature setting is done at the touch panel.	Set the operation mode to "DIO".	To display the "DIO"
SERIAL	Run / stop and circulating fluid temperature setting are possible with the serial communication(RS-232C,RS-485)	Set the operation mode to "SERIAL".	To display the "SERIAL"
	DIO Run/Stop Run / stop by contact input. Set circulating fluid temperature by serial communication.	Set to "SERIAL" mode and set "DIO Run / Stop" in "Serial Setting" to "ON" (enabled).	To display the "SERIAL (DIO Run)".
Ethernet	Run / stop and circulating fluid temperature setting are possible with the Ethernet Modbus/TCP communication.	Set the operation mode to " Ethernet " .	To display the "Ethernet".
	DIO Run/Stop Run / stop by contact input. Set circulating fluid temperature by Ethernet Modbus/TCP communication.	Set to " Ethernet " mode and set "DIO Run / Stop" in " Ethernet Setting" to "ON" (enabled).	To display the " Ethernet (DIO Run)".



Table 1.1-2 Operation mode and operation

Operation mode		LOCAL	DIO	SERIAL		Ethernet	
				DIO Run/Stop	DIO Run/Stop		
Touch panel	Run/Stop	○	×	×	×	×	×
Touch panel	Circulating fluid temperature setting	○	○	×	×	×	×
Touch panel	Settings other than circulating fluid temperature setting	○	○	○	○	○	○
Touch panel	Condition reading	○	○	○	○	○	○
Contact input communication	Run/Stop	×	○	×	○	×	○
Contact output communication	Condition reading	○	○	○	○	○	○
Reading of the external switch		○	○*1	○	○*1	○	○*1
Serial communication	Run/Stop	×	×	○	×	×	×
Serial communication	Circulating fluid temperature setting	×	×	○	○	×	×
Serial communication	Condition reading	○	○	○	○	○	○
Ethernet communication	Run/Stop	×	×	×	×	○	×
Ethernet communication	Circulating fluid temperature setting	×	×	×	×	○	○
Ethernet communication	Condition reading	○	○	○	○	○	○

\*1 : When Contact input 1 is set to Run / Stop, one external switch can be connected.

○ : Applicable  
× : Not applicable

## 1.2 Change of operation mode

There are the following methods to change the operation mode.

- Change by touch panel
- Change by mode request

### ■ About mode request

The mode request, is the ability to change the operation mode by the contact input or serial communication and Ethernet communication. When switching from OFF to ON for both contact input, serial communication and Ethernet communication, the mode request becomes effective and the operation mode changes.

Table 1.2-1 Operation mode change by mode request

Operation mode	Operation mode change method
LOCAL	None*1
DIO	Input the mode request signal (OFF to ON) to contact input 3.
SERIAL	The mode request flag is turned from OFF to ON by serial communication. *2
Ethernet	The mode request flag is turned from OFF to ON by Ethernet communication. *2

\*1 Change to LOCAL mode is possible only from touch panel operation.

\*2 When "DIO Run / Stop" is set in advance by the touch panel, run / stop is performed by the contact input signal.

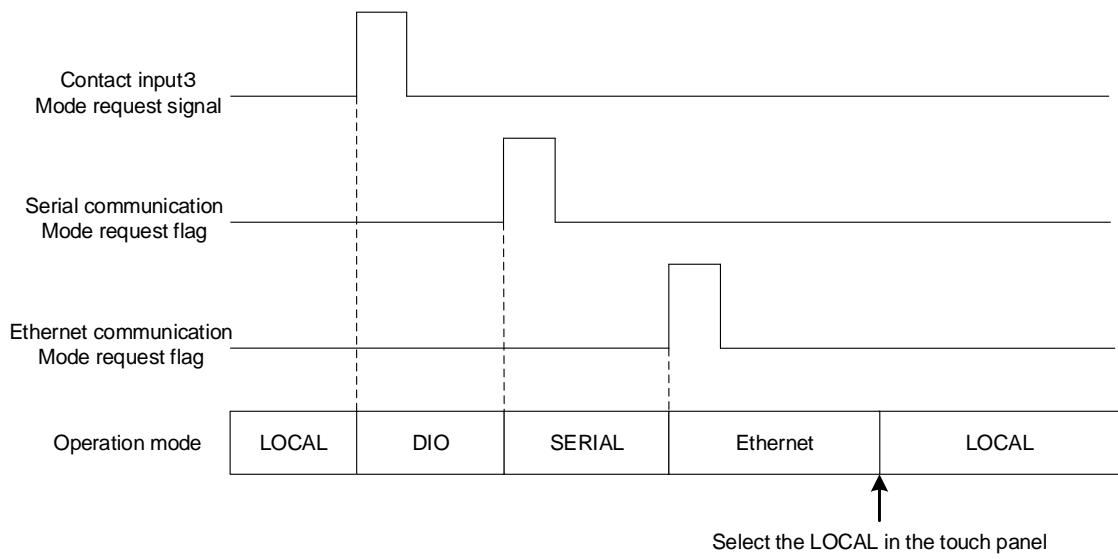

Fig. 1-1 Mode switching by the mode request (Standard)

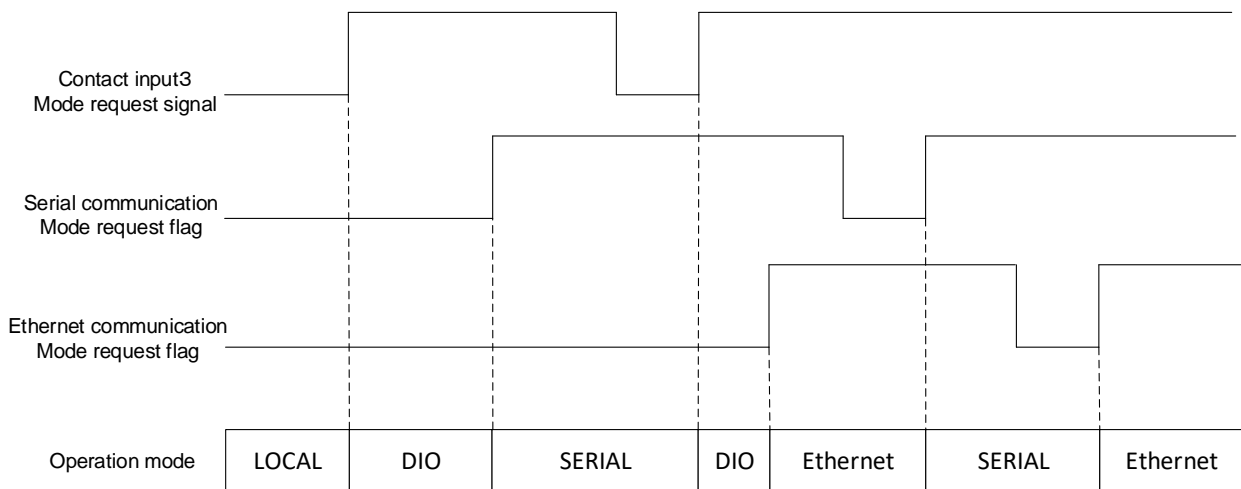

Fig.1-2 Mode switching by the mode request (ON state mixed)

## 1.3 Communication port

The communication port In the lower left of the electrical component box is used for communication.

Fig.1-3 shows the location of the communication port.

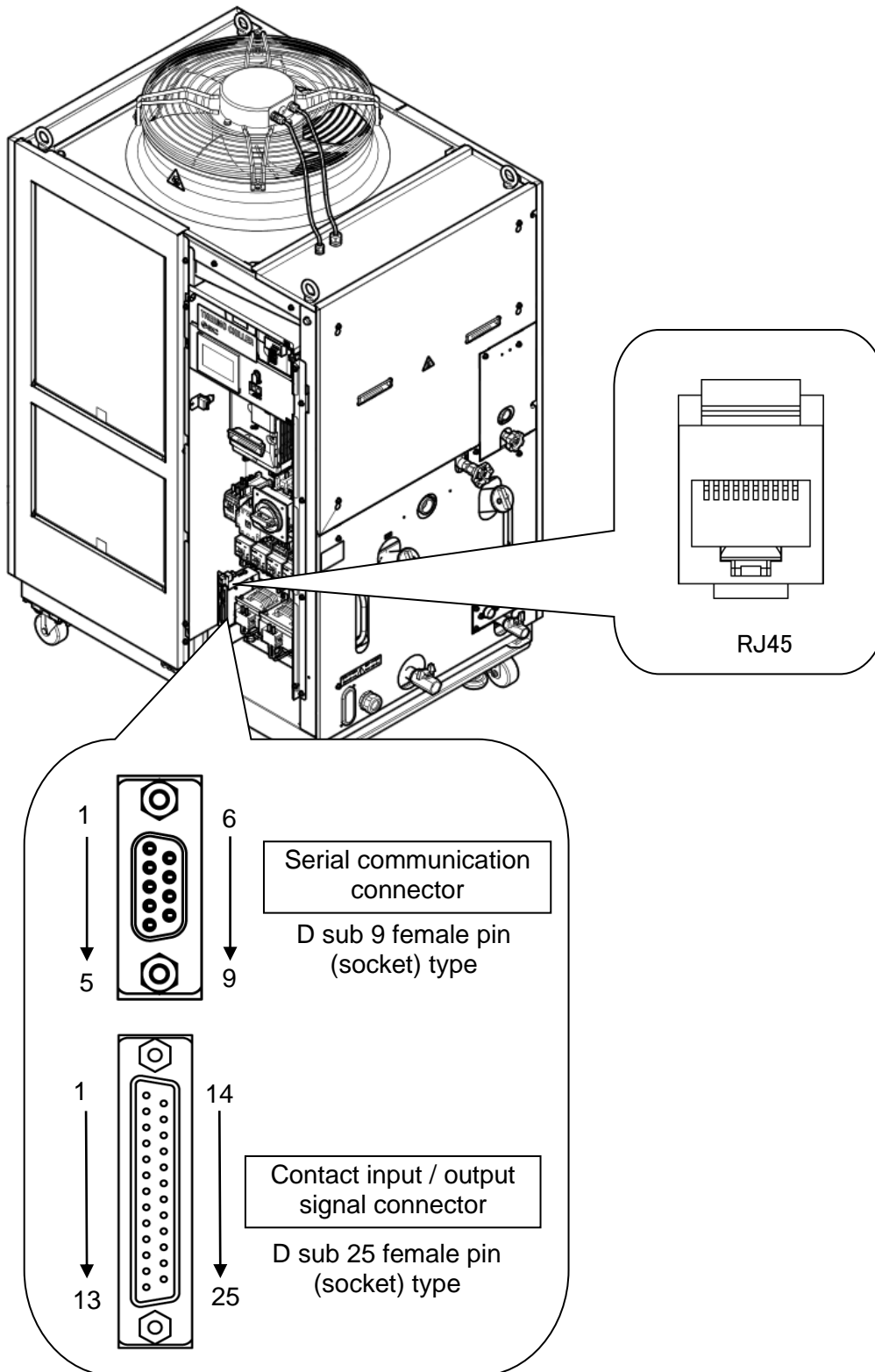

Fig.1-3 Communication port

# 1.4 Touch panel flow

Press the [Comm. Setting] on the menu, make the communication settings from the various setting screens.

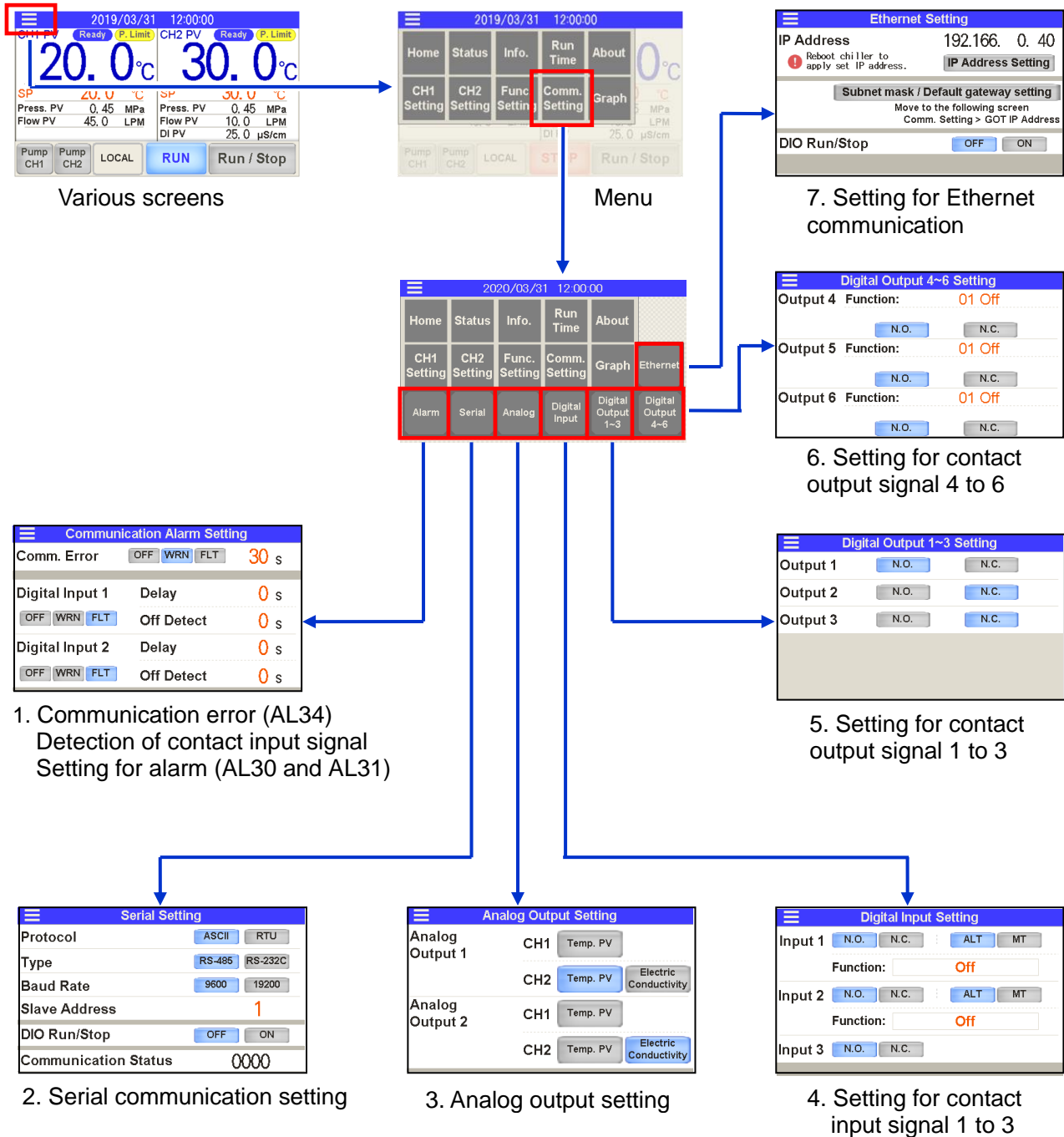

Fig.1-4 Communication setting touch panel flow

# Chapter 2 Contact input/output communication/Analog output communication

The device is equipped with a terminal which runs/stops the product. It is also equipped with a terminal which picks up operation signals, alarm signals and setting condition.

The device starts contact input/output communication according to the setting of the operation display panel. Contact input/output communication can be customized by changing the settings. The contact input / output signals and analog output signals that this product is equipped with are shown in Table 2-1.

Table 2-1 Contact input / output signal and analog output signal

Signal		Signal content
Contact input 3pcs.	Contact input 1	<ul style="list-style-type: none"> <li>Operation / stop signal, Allowed input an external switch signal</li> <li>Selectable signal configuration (Alternate/Momentary)</li> </ul>
	Contact input 2	<ul style="list-style-type: none"> <li>Selectable contact type (normally open / normally closed)</li> </ul>
	Contact input 3	Mode request signal only (momentary)
Contact output 6 pcs.	Contact output 1	<ul style="list-style-type: none"> <li>Output operation status (RUN / STOP) signal *1</li> <li>Selectable contact type (normally open / normally closed)</li> </ul>
	Contact output 2	<ul style="list-style-type: none"> <li>Output the operation stop "FLT" alarm signal *1</li> <li>Selectable contact type (normally open / normally closed)</li> </ul>
	Contact output 3	<ul style="list-style-type: none"> <li>Output the continued operation "WRN" alarm signal *1</li> <li>Selectable contact type (normally open / normally closed)</li> </ul>
	Contact output 4	Selectable signal content(Refer to "2.4 Contact output signal")
	Contact output 5 Contact output 6	Selectable contact type (normally open / normally closed)
Analog output 2pcs.	Analog output 1	Selectable from the following <ul style="list-style-type: none"> <li>CH1 Circulating fluid discharge temperature</li> <li>CH1 Circulating fluid electric conductivity *2</li> </ul>
	Analog output 2	<ul style="list-style-type: none"> <li>CH2 Circulating fluid discharge temperature</li> <li>CH2 Circulating fluid electric conductivity</li> </ul>

\*1 Signal the contents of the contact output 1 to 3 is a fixed value. It is not possible to change the content of the signal.

\*2 For option D1 "CH1 Electric conductivity control", you can select it.

## 2.1 Precautions for communication

### 2.1.1 Precautions wiring communication

#### ○Communication wiring

A communication cable that connects the product and customer system is not included with the product. Please prepare according to "3.2 Connected explanation". In order to avoid malfunction, do not connect to any place other than those shown in "3.2 Connected explanation".

#### ○Power supply

To use the power of the product, the total load current must be 200mA or less.

## 2.1.2 Precautions after wiring and before communication

○ Check or set the Operation mode by the touch panel.

• Operation mode shall be DIO.

You can read also in the other mode, but you can not run / stop if it is not DIO mode.

## 2.2 Communication specification

Table 2.2-1 Contact input/output communication connector

Connector specification (this product side)
Dsub 25 pin female (socket) type

Table 2.2-2 Contact input/output/ analog output communication specification

Item		Specification	
Contact input signal 1,2,3	Insulation system	Photo coupler	<ul style="list-style-type: none"> <li>• Run/Stop signal</li> <li>• External switch signal</li> <li>• Operation mode request signal (Contact input 3 fixed)</li> </ul>
	Rated input voltage	DC24V	
	Operating voltage range	DC21.6V to 26.4V	
	Rated input current	5mA TYP	
	Input impedance	4.7kΩ	
Contact output signal 1,2,3,4,5,6	Rated load voltage	AC48V or less / DC30V or less	<ul style="list-style-type: none"> <li>• Signal of operating status</li> <li>• Alarm signal</li> <li>• TEMP READY signal etc *2</li> </ul>
	Maximum load current	AC/DC 800mA or less *1	
	Minimum load current	DC5V 10mA	
Analog output signal 1,2	Output voltage range	0V to +10V	<ul style="list-style-type: none"> <li>• CH1 Circulating fluid discharge temperature</li> <li>• CH1 Circulating fluid electric conductivity *3</li> <li>• CH2 Circulating fluid discharge temperature</li> <li>• CH2 Circulating fluid electric conductivity</li> </ul>
	Maximum output current	10mA	
	Maximum accuracy	±1.0%F.S. or less	
DC24V output voltage		DC24V±10% 200mA MAX *1 (It can not be used for inductive load.)	

\*1 : The total load current must be 800 mA or less. To use the power of the device, the total load current must be 200 mA or less.

\*2 : Refer to “2.4.2 Contact output signal 4 to 6”.

\*3 : For option D1 “CH1 Electric conductivity control”, it can be set.

Table 2.2-3 Contact input/output communication /Analog output pin number

PIN No.	Item	Division	Factory default
1	DC24V output	Output	—
2	DC24V input	Input	—
3	Contact input signal 1	Input	Run/Stop *1
4	Contact input signal 3	Input	Operation mode request signal (fix ) *2
5	Contact output signal 6	Output	OFF*1
6	Contact output signal 1	Output	Run status signal [N.O type](fix) *2
7	Contact output signal 3	Output	Operation continuation[WRN]alarm status signal [N.C. type ](fix) *2
8	Contact output signal 5	Output	OFF*1
9	None	—	Can not connect *3
10	Analog output signal 2	Output	CH2 Circulating fluid electric conductivity signal *1
11	Analog output signal 1	Output	CH2 Circulating fluid discharge temperature signal *1
12	None	—	Can not connect *3
13	None	—	Can not connect *3
14	24 COM output (Common of contact input signal)	Output	—
15	Common of contact output signal 1, 2, 3, 4, 5	Output	—
16	Contact input signal 2	Input	External switch signal *1
17	None	—	Can not connect *3
18	Common of contact output signal 6	Output	—
19	Contact output signal 2	Output	Operation stop [FLT] alarm status signal [N.C. type ](fix) *2
20	Contact output signal 4	Output	OFF*1
21	None	—	Can not connect *3
22	Common of contact output signal 2	Output	—
23	Common of contact output signal 1	Output	—
24	None	—	Can not connect *3
25	None	—	Can not connect *3

\*1 : It is possible to change the setting.

\*2 : You can not change the setting("N.O type / N.C. type" can be changed).

\*3 : Do not wire..

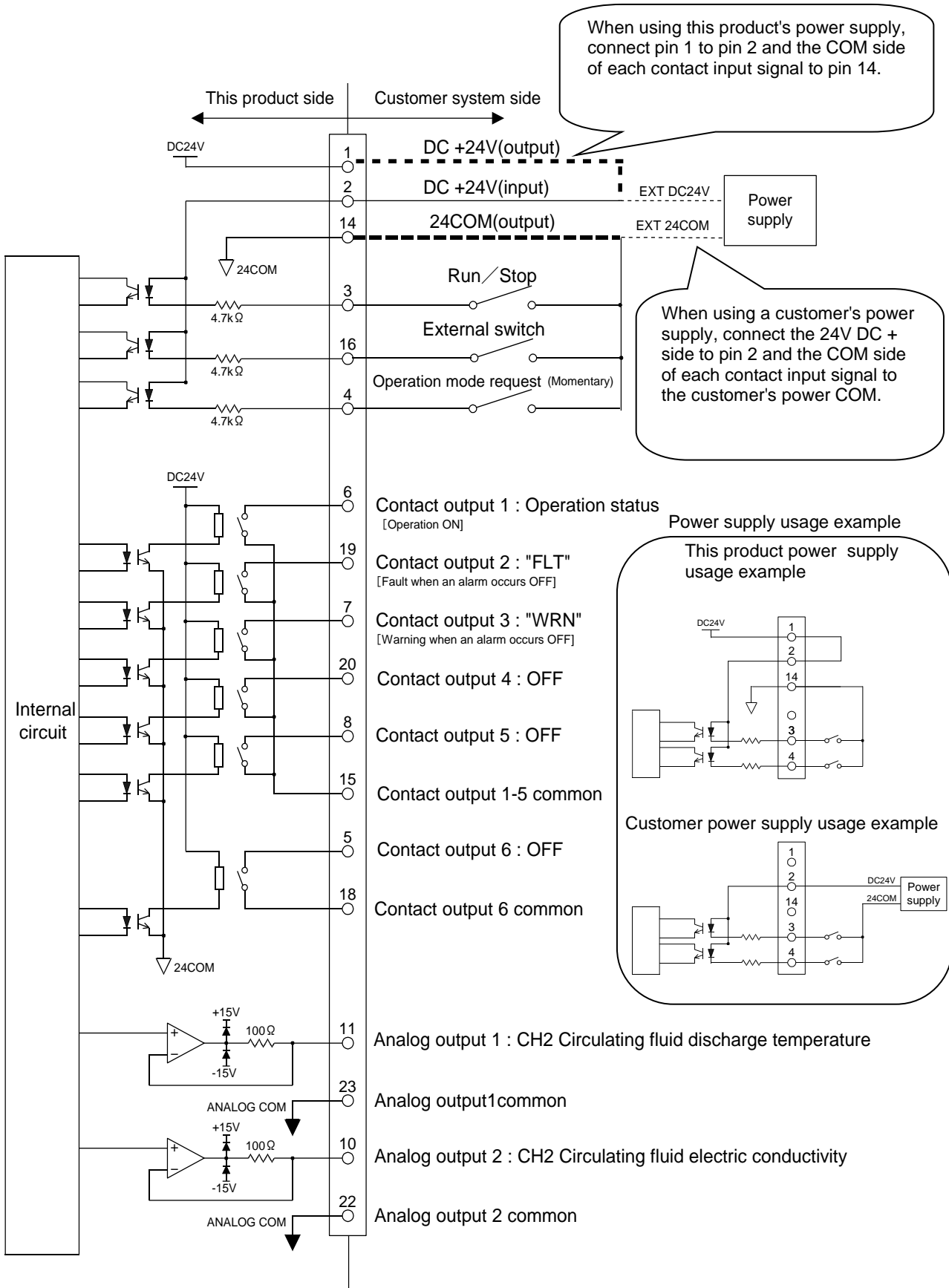

Fig.2-1 Circuit diagram



## 2.3 Contact input signal

There are 3 contact input signals. Two of them can be customized by the customer.

### 2.3.1 Setting of contact input signal type and form

The type of contact input signal can be set from the “1.4 Touch panel flow” (Refer to “4. Contact input signal form” screen).

Following items can be set for contact input signal 1 and 2:

- Contact type—selects [ N.O. ] (A contact) or [N.C] (B contact)
- Signal form—selects [ALT] (alternate) or [MT] (momentary)
- Signal type—selects “OFF” (disabled), “external switch” (external switch signal) or “run/stop” (run/stop) signal., Run (run) signal, Stop (stop)signal

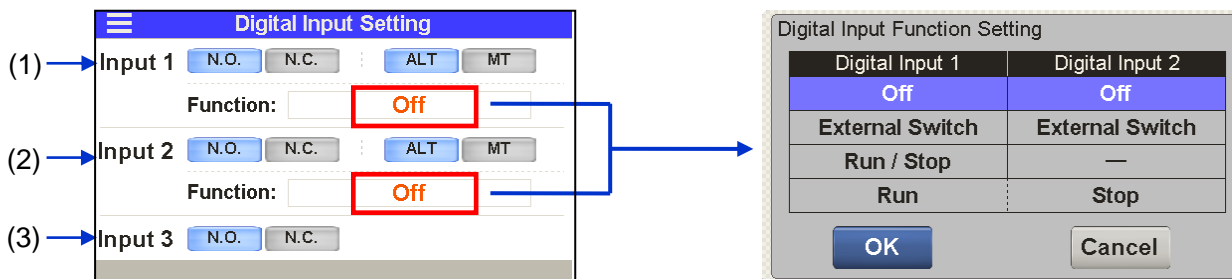

Setting of contact input signal form

Table 2.3-1 Setting of contact input signal form

No.	Indication	Item	Setting and selection		
(1)	Input 1	Contact input signal 1	Contact type	<input type="button" value="N.O."/> *1	A contact (normally open)
				<input type="button" value="N.C."/>	B contact (normally closed)
			Signal form	<input type="button" value="ALT"/> *1	Alternate
				<input type="button" value="MT"/>	Momentary
			Signal type	<input type="button" value="[Off]"/>	Disabled
				<input type="button" value="[External Switch]"/>	External switch signal
				<input type="button" value="[Run/Stop]"/> *1	Run/stop signal
		<input type="button" value="[Run]"/> *2	Run signal		
(2)	Input 2	Contact input signal 2	Contact type	<input type="button" value="N.O."/> *1	A contact (normally open)
				<input type="button" value="N.C."/>	B contact (normally closed)
			Signal form	<input type="button" value="ALT"/> *1	Alternate
				<input type="button" value="MT"/>	Momentary
			Signal type	<input type="button" value="[Off]"/>	Disabled
				<input type="button" value="[External Switch]"/> *1	External switch signal
				<input type="button" value="[Stop]"/> *2	Stop signal
(3)	Input 3	Contact input signal 3 *3	Contact type	<input type="button" value="N.O."/> *1	A contact (normally open)
				<input type="button" value="N.C."/>	B contact (normally closed)

\*1 : By default.

\*2 : This setting assigns “run” signal to “contact input 1” and “stop” signal to “contact input 2”.

\*3 : The signal form of contact input 3 is “momentary”.

### 2.3.2 Run/stop·Run·Stop·External switch signal

- 1) Run/stop signal (Signal type: Alternate)  
The product keeps operating while the input signal from the customer is ON.

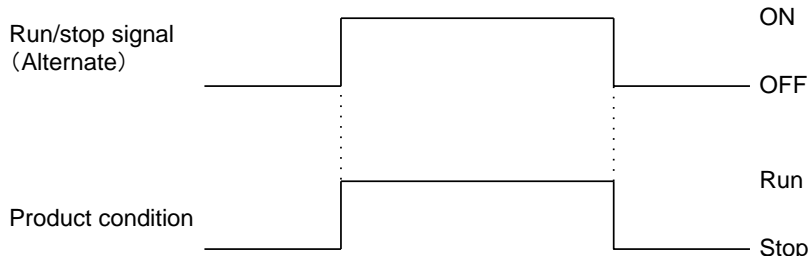

- 2) Run/stop signal (Signal type: Momentary)  
The state changes when the input signal from the customer goes ON. This signal operates while the product is stopped, and stops while the product is being operated.

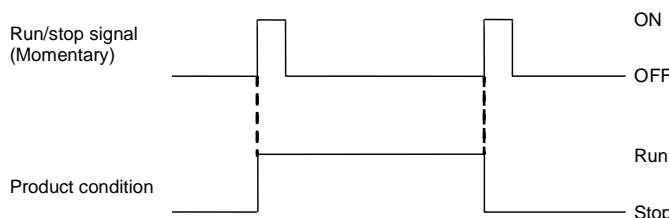

- 3) Run signal (Signal type: Alternate) /Stop signal (Signal type: Alternate)  
Digital input signal 1 is for Run signal (Signal type : Alternate) , digital input signal 2 is for stop signal(Signal type: Alternate). Stop signal becomes valid when both signals are turned ON.

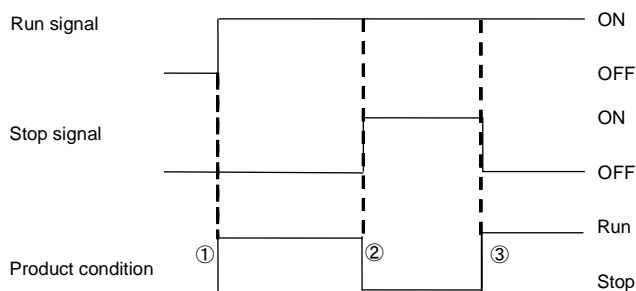

- (1) The product starts operation when the contact input signal 1 is turned ON.
- (2) The product stops operation when the contact input signal 2 is turned ON.
- (3) The product starts operation because the contact input signal 1 is turned ON although the contact input signal 2 is OFF.

- 4) Digital input signal 1 is for Run/Stop signal (Signal type: Alternate), digital input signal 2 is for external switch signal (Signal type: Alternate). Refer to Chapter 2.3.3 for details of the external switch.

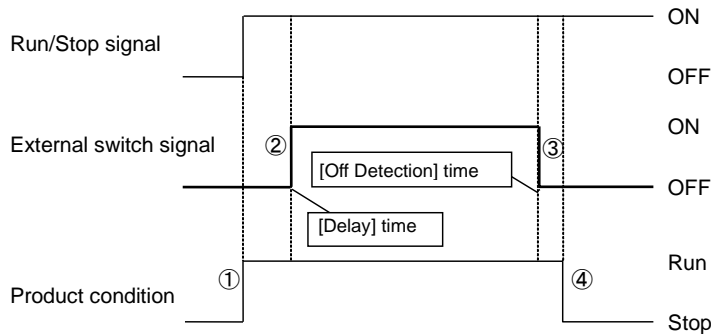

- (1) The product starts operation when the Run/Stop signal from the user is turned ON.
- (2) It reads the signal of the external switch signal (N.O type) after the time which has been set for the [Delay] time.
- (3) When the external switch signal (N.O. type) has been turned off for the time set for [Off Detection] time, it is recognized as OFF.
- (4) Alarm [AL31:Contact input 2 signal detection] is generated. The operation of the product stops.
- (5) The product stops operation when the Run/Stop signal is turned OFF during operation. Afterwards, the alarm is not generated even if the external switch signal is turned OFF.

### 2.3.3 External switch signal

The product has two contact inputs available to detect the contact input signal. This allows reading and monitoring the contact signal from an external switch. When inputting an external switch signal to the contact input, select “External Switch” (external switch signal) for the type of contact input signal. (Refer to “2.3.1 Setting of contact input signal type and form”)

If an input from an external switch is detected, it can be generated as an alarm. Options to select “continuous monitoring” or “monitoring during operation” are available. Also, the detection start time after the start of operation and the detection end time can be set.

- If the signal of “contact input 1” is detected: the alarm “AL30: Detection of contact input 1 signal” is activated.
- If the signal of “contact input 2” is detected: the alarm “AL31: Detection of contact input 2 signal” is activated.
- “Delay” time: sets the start time to detect the contact input signal after the start of operation.
- “Off detect” time: sets the time between the detection of the contact input OFF signal and the activation of the alarm.

Table 2.3-2 Monitoring method for contact input signal

“Delay” time	Monitoring method
0sec	Continuous monitoring
1 to 300sec	Monitoring during operation

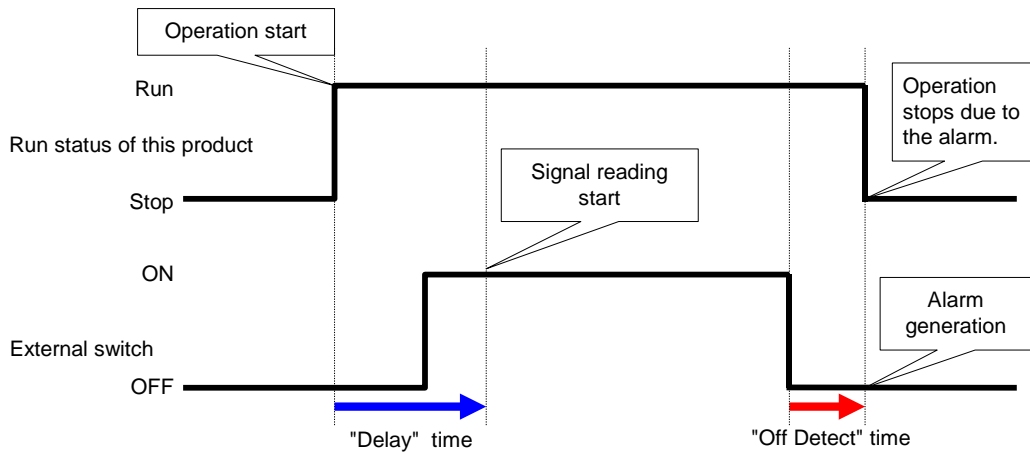

"Delay" time and "off detect" time

You can select the operation of this product when an alarm occurs by the contact input signal.

- [WRN]—Continue operation of the product when an alarm occurs
- [FLT]—Stop operation of this product when an alarm occurs

Set "Delay" time, "Off Detect" time and "Operation at alarm occurrence" of external switch signal from "1.4 Touch panel flow (Refer to "1. Communication error (AL34), contact input signal detection alarm (AL30, AL31) setting"screen).

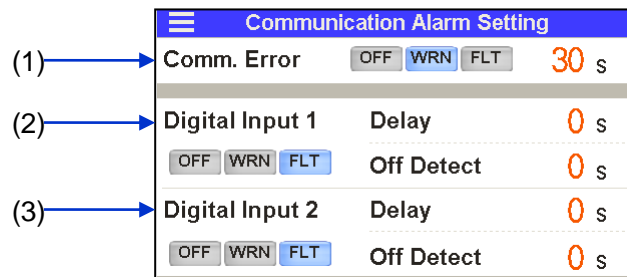

Communication error, detection alarm of contact input signal and setting

Table 2.3-3 Communication error, detection of contact input signal and operation setting

No.	Indication	Item	Setting and selection		Setting range	
(1)	Comm. Error	Alarm "AL34: Communication error"	<input type="button" value="OFF"/>	Disabled	Waiting time	30 to 600sec *30sec
			<input type="button" value="WRN"/> *	Operation continues during the alarm		
			<input type="button" value="FLT"/>	Operation stops during alarm		
(2)	Digital Input 1	Alarm "AL30: Detection of contact input 1 signal"	<input type="button" value="OFF"/>	Disabled	Delay	0 to 300sec *0sec
			<input type="button" value="WRN"/>	Operation continues during the alarm	Off Detect	0 to 10sec *0sec
			<input type="button" value="FLT"/> *	Operation stops during alarm		
(3)	Digital Input 2	Alarm "AL31: Detection of contact input 2 signal"	<input type="button" value="OFF"/>	Disabled	Delay	0 to 300sec *0sec
			<input type="button" value="WRN"/>	Operation continues during the alarm	Off Detect	0 to 10sec *0sec
			<input type="button" value="FLT"/> *	Operation stops during alarm		

\* By default

## 2.4 Contact output signal

There are 6 contact output signals. The setting of the contact output signal is done by the "5. Contact output signal 1 to 3 Setup" screen and "1.4 Touch panel flow" (Refer to "6. Contact output signal 4 to 6 setting" screen).

Contact output signal 4 to 6 can be used to change the signal type.

### 2.4.1 Contact output signal 1 to 3

The contact type of contact output signals 1 to 3 can be set. Contact output signal is continuously output.

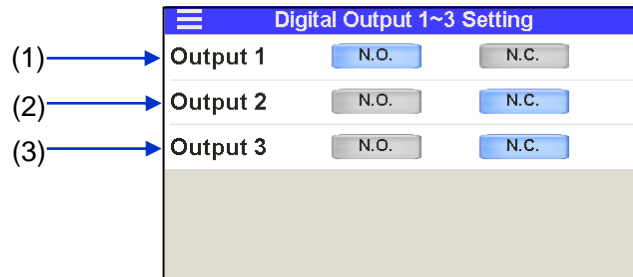

Setting of contact output signal 1 to 3

Table 2.4-1 Setting of contact output signal 1 to 3

No.	Indication	Item	Signal type	Setting and selection	
(1)	Output 1	Contact output signal 1	Operation status signal	<input type="button" value="N.O."/> *	A contact (normally open)
				<input type="button" value="N.C."/> *	B contact (normally closed)
(2)	Output 2	Contact output signal 2	Operation stop (FLT) alarm status signal	<input type="button" value="N.O."/> *	A contact (normally open)
				<input type="button" value="N.C."/> *	B contact (normally closed)
(3)	Output 3	Contact output signal 3	Continuous operation "WRN" alarm status signal	<input type="button" value="N.O."/> *	A contact (normally open)
				<input type="button" value="N.C."/> *	B contact (normally closed)

\* By default

### 2.4.2 Contact output signal 4 to 6

Contact output signal 4 to 6 can be set to "signal type", "contact form". A "signal type" for contact output signal 4 to 6 can be selected by the customer. Refer to "Table 2.4-3 Signal type for contact output signals 4 to 6."

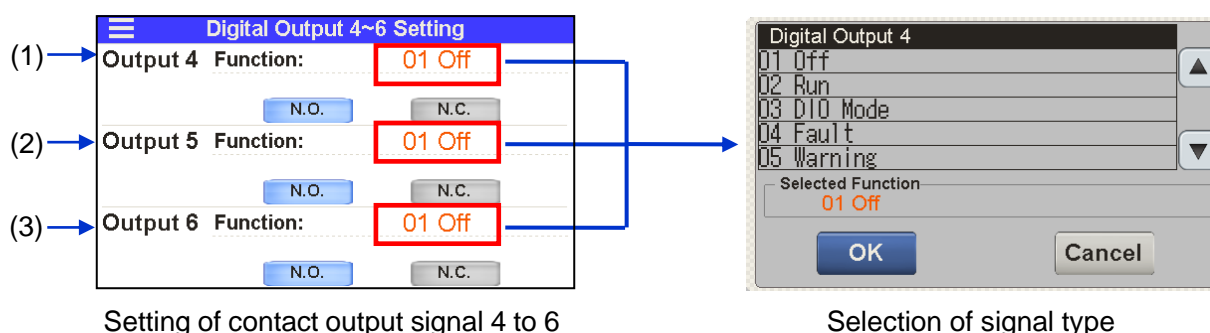

Setting of contact output signal 4 to 6

Selection of signal type

Table 2.4-2 Setting of contact output signal 4 to 6

No.	Indication	Item	Signal type	Contact type	
(1)	Output 4 Function	Contact output signal 4	Select from "Table 2.4-3 Signal type for contact output signal 4 to 6" * [OFF]	<input type="button" value="N.O."/> *	A contact (normally open)
				<input type="button" value="N.C."/> *	B contact (normally closed)
(2)	Output 5 Function	Contact output signal 5		<input type="button" value="N.O."/> *	A contact (normally open)
				<input type="button" value="N.C."/> *	B contact (normally closed)
(3)	Output 6 Function	Contact output signal 6		<input type="button" value="N.O."/> *	A contact (normally open)
				<input type="button" value="N.C."/> *	B contact (normally closed)

\* By default

Table 2.4-3 Signal type for contact output signal 4 to 6

No.	Indication	Item	Contact type	Explanation
1	Off	Disabling	N.O.	Normally open
			N.C.	Normally open
2	Run	Operation status signal	N.O.	Operation : closed
			N.C.	Stop : closed
3	DIO Mode	DIO mode signal	N.O.	DIO mode : closed
			N.C.	DIO mode : open
4	Fault	Operation stop "FLT" alarm status signal	N.O.	the time of alarm : closed
			N.C.	the time of alarm : open
5	Warning	Continuing operation "WRN" alarm status signal	N.O.	the time of alarm : closed
			N.C.	the time of alarm : open
6	Alarm	alarm status signal	N.O.	the time of alarm : closed
			N.C.	the time of alarm : open
7	Maintenance	maintenance reminder status signal	N.O.	Maintenance reminders occurred : closed
			N.C.	Maintenance reminders occurred : open
8	CH1 TEMP READY	CH1 TEMP READY signal	N.O.	TEMP READY status : closed
			N.C.	TEMP READY status : open
9	CH2 TEMP READY	CH2 TEMP READY signal	N.O.	TEMP READY status : closed
			N.C.	TEMP READY status : open
10	TEMP OUT	TEMP OUT signal	N.O.	TEMP READY status : closed
			N.C.	TEMP READY status : open
11	EXTERNAL TEMP	None	—	—
12	START-UP	Startup setting status signal	N.O.	Enabled : closed
			N.C.	Enabled : open
13	ANTI-FREEZING	Anti-freezing setting status signal	N.O.	Enabled : closed
			N.C.	Enabled : open
14	WARMING UP	Warming up setting status signal	N.O.	Enabled : closed
			N.C.	Enabled : open
15	Digital Input 1	Pass through signal of the contact input signal 1	N.O.	Output the input signal as it is
			N.C.	Reverse output of the input signal
16	Digital Input 2	Pass through signal of the contact input signal 2	N.O.	Output the input signal as it is
			N.C.	Reverse output of the input signal
17	Mode Request Input	Mode request input signal(DIO) (Pass through signal of the contact input signal 3)	N.O.	Output the input signal as it is
			N.C.	Reverse output of the input signal
18	Select Alarm	Selected alarm status signal	N.O.	Selected alarm occurrence : closed
			N.C.	Selected alarm occurrence : open
Refer to "Table 2.4-4 List of alarm selection" for selectable alarms.				
19	Select Maintenance	Maintenance reminders status signal	N.O.	Selected maintenance reminders occurred : closed
			N.C.	Selected maintenance reminders occurred : open
About selectable maintenance reminders Refer to "Table 2.4-5 List of maintenance reminders".				



Table 2.4-4 List of alarm selection

Alarm No.	Indication	Explanation
AL01	CH1 Low Level FLT	CH1 abnormal low tank fluid level
AL02	CH1 Low Level WRN	CH1 low tank fluid level
AL03	CH2 Low Level FLT	CH2 abnormal low tank fluid level
AL04	CH2 Low Level WRN	CH2 low tank fluid level
AL06 *3	Fan Inverter	Fan failure
AL07 *4	Internal Cooling Fan	Air exhaust fan failure.
AL09	CH1 High Temp. FLT	CH1 abnormal rise of circulating fluid temperature
AL10	CH1 High Temp.	CH1 circulating fluid temperature rise
AL11	CH1 Low Temp.	CH1 circulating fluid temperature drop
AL12	CH1 TEMP READY ALARM	CH1 TEMP READY alarm
AL13	CH2 High Temp. FLT	CH2 abnormal rise in circulating fluid temperature
AL14	CH2 High Temp.	CH2 circulating fluid temperature rise
AL15	CH2 Low Temp.	CH2 circulating fluid temperature drop
AL16	CH2 TEMP READY ALARM	CH2 TEMP READY alarm
AL17	CH1 HX In High Temp. FLT	CH1 abnormal rise in heat exchanger inlet temperature
AL18	CH1 Press. Sensor	CH1 failure of circulating fluid discharge pressure sensor
AL19	CH1 High Press.	CH1 circulating fluid discharge pressure rise
AL20	CH1 Low Press.	CH1 circulating fluid discharge pressure drop
AL21	CH2 Press. Sensor	CH2 failure of circulating fluid discharge pressure sensor
AL22	CH2 High Press. Error	CH2 abnormal rise in circulating fluid discharge pressure
AL23	CH2 High Press.	CH2 circulating fluid discharge pressure rise
AL24	CH2 Low Press.	CH2 circulating fluid discharge pressure drop
AL25	CH2 Low Press. Error	CH2 abnormal drop in circulating fluid discharge pressure
AL26	CH2 Flow Sensor	CH2 failure of circulating fluid discharge flow sensor
AL27	CH2 High Electric Conductivity	CH2 electric conductivity increase
AL28 *2	CH1 High Electric Conductivity	CH1 electric conductivity increase
AL30	Digital Input 1	Contact input 1 signal detection
AL31	Digital Input 2	Contact input 2 signal detection
AL33	CH2 Low Flow FLT	CH2 abnormal circulating fluid low flow
AL34	Communication	Communication error
AL35	Ambient Temp.	Outside of the ambient temperature range
AL36	Maintenance	Maintenance alarm
AL37	Refrigeration Circuit	Compressor circuit failure
AL38	Sensor	Sensor failure
AL39	Controller	Controller failure
AL40	Compressor Inverter	Compressor inverter error
AL41	Compressor Inverter Comm.	Compressor inverter communication error
AL42	CH1 Pump Inverter	CH1 pump inverter error
AL43	CH1 Pump Inverter Comm.	CH1 pump inverter communication error
AL44	CH2 Pump Inverter	CH2 pump inverter error
AL45	CH2 Pump Inverter Comm.	CH2 pump inverter communication error

\*1 Refer to Operation Manual "Installation · Operation".

\*2 For option D1 "CH1 Electric conductivity control", you can select it.

\*3 For Air-cooled refrigerated type model, you can select it.

\*4 For Water-cooled refrigerated type model, you can select it.

Table 2.4-5 List of maintenance reminders \*1

Maintenance No.	Indication	Explanation
MT01	CH1 Pump	CH1 pump maintenance
MT02	Compressor	Compressor maintenance
MT03 *4	Fan	Fan maintenance
MT04 *4	Dustproof Filter	Dust-proof filter maintenance
MT05	DI Filter	CH2 DI filter maintenance
MT06	CH2 Pump	CH2 pump maintenance
MT07	Low Battery	Battery maintenance
MT08	CH1 Pressure Sensor	Maintenance for CH1 circulating fluid discharge pressure sensor
MT09	CH2 Pressure Sensor	Maintenance for CH2 circulating fluid discharge pressure sensor
MT10	CH2 Flow Sensor	Maintenance for CH2 circulating fluid flow sensor
MT11 *2	CH1 DI Filter	CH1 DI filter maintenance
MT12 *3	CH2 Mechanical Seal	CH2 Mechanical Seal mentenance

\*1 Refer to Operation Manual "Installation · Operation".

\*2 In the case of option D1 "CH1 with electrical conductivity control", to display.

\*3 In the case of option T3 "CH2 High Pressure Pump Mounted", to display.

\*4 In the case of air-cooled refrigerated type, to display.

## 2.5 Analog output signal

The product has two analog outputs.

Setting of the analog output signal is done by the "1.4 Touch panel flow" (Refer to "3. Analog Output Settings" screen).

The following signals can be output as analog signals:



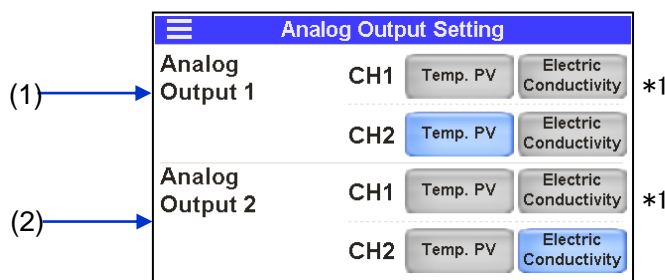





- Analog output signal 1—“CH1 circulating fluid discharge temperature”, “CH2 circulating fluid discharge temperature” or “CH1 circulating fluid electric conductivity”\*1, “CH2 circulating fluid electric conductivity”.
- Analog output signal 2—“CH1 circulating fluid discharge temperature”, “CH2 circulating fluid discharge temperature” or “CH1 circulating fluid electric conductivity”\*1, “CH2 circulating fluid electric conductivity”.

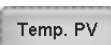

Setting of analog output signal

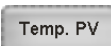
\*1 For option D1 “CH1 Electric conductivity control”, it can be set.

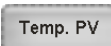
Table 2.5-1 Setting of analog output signal

No.	Indication	Item	Setting, selection and display	Output
(1)	Analog Output 1	Analog output signal 1	CH1  CH1 circulating fluid discharge temperature	0°C to 100°C: 0 to 10.0 V
			CH1  *2 CH1 circulating fluid discharge temperature	0°C to 100°C: 0 to 10.0 V
			CH2  *1 CH2 circulating fluid discharge temperature	0°C to 100°C: 0 to 10.0 V
			CH2  CH2 circulating fluid electrical conductivity	0.1 to 50.0 μS/cm: 0.02 to 10.0 V
(2)	Analog Output 2	Analog output signal 2	CH1  CH1 circulating fluid discharge temperature	0°C to 100°C: 0 to 10.0 V
			CH1  *2 CH1 circulating fluid electrical conductivity	0.1 to 50.0 μS/cm: 0.02 to 10.0 V
			CH2  CH2 circulating fluid discharge temperature	0°C to 100°C: 0 to 10.0 V
			CH2  *1 CH2 circulating fluid electrical conductivity	0.1 to 50.0 μS/cm: 0.02 to 10.0 V

\*1 By default.

\*2 For option D1 “CH1 Electric conductivity control”, it can be set.



# Chapter 3 Serial communication

Serial communication (RS-485/RS232C) enables the remote control of run/start of the product, temperature setting and details of product condition, and alarm condition can be obtained.

The operating state of the product (run/stop) and the temperature setting can be monitored by sending a request message made by the program of the host computer (e.g. PC).

The communication protocol is Modbus protocol.

## 3.1 Precautions wiring communication

### ○Communication wiring

A communication cable that connects the product and customer system is not included with the product. Please prepare a cable, referring to 3.2 "Connected explanation" In order to avoid malfunction, do not connect to any place other than those shown in 3.2 "Connected explanation".

## 3.2 Connected explanation

Fig.3-1 shows the wiring when RS-485 is selected as the communication standard. Fig.3-2 shows the wiring when RS-232C is selected.

A communication cable that connects the product and customer system is not included with the product. Prepare a cable, referring to Fig.3-1 or Fig 3-2.

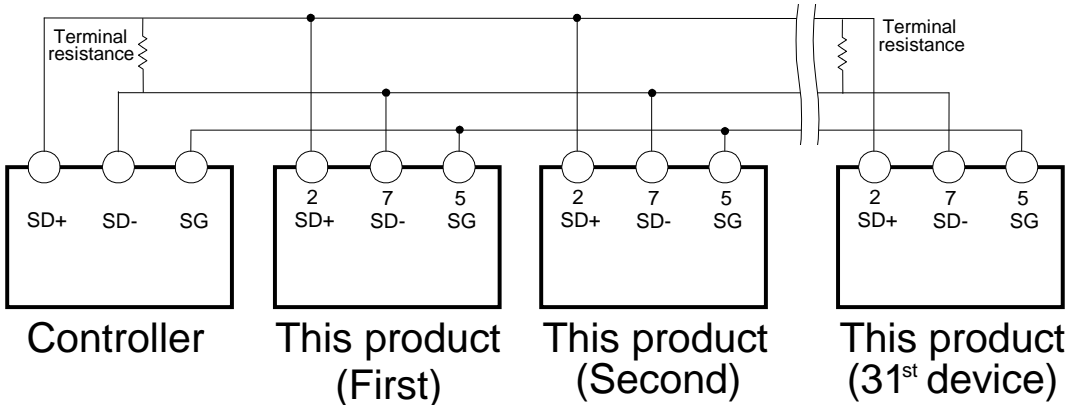

**Do not connect any wire to other PIN numbers.**

Fig 3-1 RS-485 connector connection

**[Tips]**

- 1 master : 1 product, or 1 master: N products.  
 In the latter case, up to 31 products can be connected.
- Both ends of the communication connection (the end nodes) need to be connected to the higher level computer.

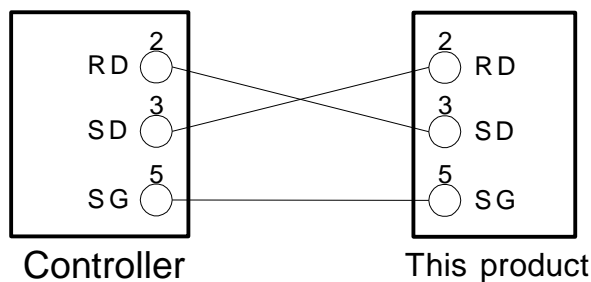

**Do not connect any wire to other PIN numbers.**

Fig 3-2 RS-232C connector connection

### 3.3 Communication specification

Table 3.3-1 Serial communication specification

Item	Specification
Connector type (for the product)	D-sub9P type Female connector
Standard	Select from EIA RS-485 / RS-232C
Circuit type Half duplex	Half duplex
Transmission type	Start-stop
Protocol	Modbus terminal*1
Terminal resistance	None

■ :Default setting

\*1 : Refer to Modicon Co. protocol specifications "PI-MBUS-300 Rev.J".

Table 3.3-2 Communication specification of Modbus communication function

Item	Specification
Standard	Select from EIA RS-485 / RS-232C
Communication speed	Select from 9600bps / 19200bps
Data-bit length	7bit(ASCII) / 8bit(RTU)
Stop-bit length	1bit
Data transfer direction	LSB
Parity	Even parity
Letter code	ASCII character string (ASCII) / Binary data(RTU)
Node type	Slave (Controller)
Slave address set range	Select from 1 to 32 address
Error check	LRC method (ASCII) / CRC method (RTU)

□:Default setting

## 3.4 Modbus communication function

Modbus protocol is a communication protocol developed by Modicon. It is used to communicate with a PC or PLC.

Register content is read and written by this communication protocol.

This communication has the following features.

- Controls run/stop.
- Sets and reads the circulating fluid set temperature.
- Reads the circulating fluid discharge temperature.
- Reads the circulating fluid discharge pressure.
- Reads the circulating fluid flow rate.
- Reads the circulating fluid electric conductivity(CH2 only).
- Reads the condition of the product.
- Reads the alarm generating condition of the product.
- The operation mode can be switched to "SERIAL" mode.
- You can reset the alarm.

Refer to "3.13 Register Map" for the register of the product.

## 3.5 Precautions for communication

### 3.5.1 Precautions after wiring and before communication

○ Check or set the each communication setting by the touch panel.

- The communication specification shall be the customer's communication standard.
- The operation mode shall be the SERIAL mode. (When mode request flag is activated, SERIAL mode is selected. Refer to 3.13.9).

Other modes can perform reading, but only SERIAL mode can perform writing.

○ Check or set the communication parameters using the touch panel.

Check or set the communication speed so that the product synchronizes with the host computer (master) prepared by the customer.

○ Check the slave address by the touch panel.

No response is returned when a request message is sent from a slave address other than those set in the product.

### 3.5.2 Precautions for communicating

○ Allow a suitable interval between requests.

To send request messages in series, wait for 100 msec. or longer after receiving a response message from the product before sending the next message.

○ Retry (resend request message).

The response may not be returned due to noise. If no message is returned 1sec. after sending a request message, resend the request message.

○ If necessary send a read request message to check if it was written correctly.

Message to notify the completion of the process is returned when the action for the written request message is completed.

Send a read request message to confirm if the setting was written as requested.

○ Setting limit of circulating fluid temperature

When the circulating fluid set temperature is written by communication, the data is stored in FRAM. When the product restarts, it restarts with the value which was set before the restart. The number of times it is possible to overwrite FRAM is limited. Data is only stored in FRAM when it receives a circulating fluid set temperature which is different from the previous temperatures. Please check how many times it is possible to overwrite FRAM, and avoid unnecessary changes of the circulating fluid set temperature during communication



## 3.6 Setting method

Set of serial communication is done from “1.4 Touch panel flow” (Refer to "2. Serial communication settings" screen).

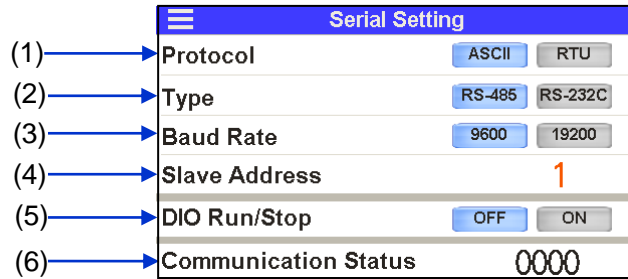

Serial communication setting

Table 3.6-1 Setting of serial communication

No.	Indication	Item	Setting, selection and display		Default setting
(1)	Protocol	Communication format	ASCII	ASCII code	○
			RTU	Binary data	-
(2)	Type	Standard	RS-485	EIA RS-485	○
			RS-232C	EIA RS-232C	-
(3)	Baud Rate	Communication speed	9600	9600 bps	-
			19200	19200 bps	○
(4)	Slave Address	Slave address	1 to 32	Select from 1 to 32	1
(5)	DIO Run/Stop *1	“Run/stop” by contact input	OFF	Disabled	○
			ON	Enabled	-
(6)	Communication Status	Communication status *2	0000	Displays the communication status	-

\*1 “Run/stop” operation of the product is carried out by the contact input signal, and by reading/writing the “change in set value of circulating fluid temperature” and “operation status” by serial communication.

\*2 It is a function to display the status of serial communication. Slave address mismatch or register map of this product display relevant contents for communication nonconformities, such as accessing outside the area. The table 3.6-2 shows the display and its contents.

Table 3.6-2 Communication status

Communication setting	Contents
8001	Normal message
4801	An abnormal number of data has been sent from the customer device.
4401	This product is trying to access to the outside address of the register map that support.Or trying to write to read-only address.
4201	Function code that this product does not support is being sent from the customer's equipment.
0081	The slave addresses set for this product and customer's device are different.
0041	CRC (*1) does not match in the RTU settings.
0021	LRC (*1) does not match in the ASCII settings.
00XX(*2)	Mismatched communication settings(Baud Rate, parity, number of data bits, etc.)or very short message intervals from customer equipment.
0000(*3)	Bad wiring or no message sent from customer equipment.

(\*1) CRC(Refer to 3.10.2)、LRC(Refer to 3.10.1)。

(\*2) "XX" means that it is undefined.

(\*3) Initial state or after the outgoing message is received from the customer, and displays it in case the message is a state that can not be received was continued for 30 seconds.

## 3.7 Communication sequence

Starts with a request message from the customer's system (host), and finishes with a response message from the product (slave). This product operates as a slave. It does not send any requests.

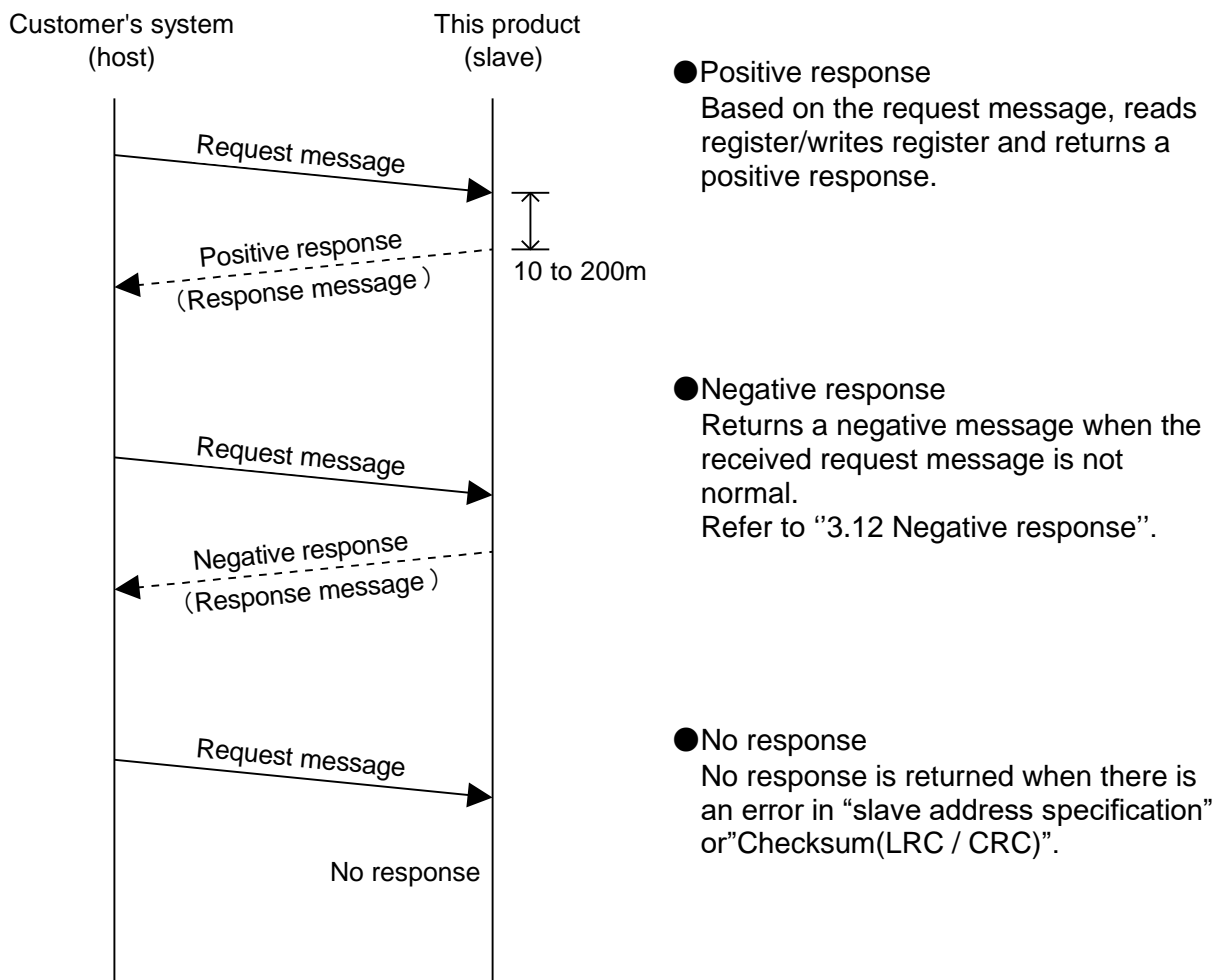

## 3.8 Message configuration

### 3.8.1 Message frame

The message configuration is shown below. The communication of this product uses 2 transmission modes, ASCII or RTU.

#### 1) ASCII mode frame

For ASCII mode, the message starts with ASCII characters ":"(3Ah) and ends with "CR/LF"(0Dh,0Ah). A response message will not be returned unless the request includes [:] and [CR][LF]. This product clears all previously received code when [:] is received.

Table 3.8-1 ASCII mode message frame

a)Start	b)Slave Address	c)Function	d)Data	e) Checksum (LRC)	f)End
[:]	XX XX	XX XX	XX ~ XX	XX XX	[CR] [LF]

a) Start

The start of the message. [:](3Ah) (ASCII)

b) Slave Address

This is a number to identify this product. "1" is the default setting. This can be changed by the touch panel.

c) Function (Refer to "3.9 Function codes")

Command is assigned.

d) Data

Depending on the function, the address and the number of the register, the value of reading/writing are assigned.

e) LRC

LRC method

Refer to "3.10.1 LRC(ASCII)".

f) END

The end of the message. [CR](0Dh) + [LF](0Ah)

2) RTU mode frame

RTU mode starts from and ends with at least 3.5 characters of silent interval. Silent interval is indicated by T1-T2-T3-T4.

Table 3.8-2 RTU mode message frame

a)Start	b)Slave Address	c)Function	d)Data	e) Checksum (CRC)	f)End
T1-T2-T3-T4	XX	XX	XX ~ XX	XX XX	T1-T2-T3-T4

a) Start

In Modbus RTU mode, message frames are separated by a silent interval (non-communication time). At least 3.5 characters of silent interval are necessary at the beginning and the end of the communication frame.

b) Slave Address

This is a number to identify this product. "1" is the default setting. This can be changed by the touch panel.

c) Function (Refer to "3.9 Function codes")

Command is assigned.

d) Data

Depending on the function, the address and the number of the register, the value of reading/writing are assigned.

e) CRC

CRC method.

Refer to "3.10.2 CRC(RTU)".

f) End

3.5 characters of silent interval indicates the end of a message.

## 3.9 Function codes

Table 3.9-1 shows function codes to read or write register. Refer to "3.11 Explanation of function codes".

Table 3.9-1 Function codes

NO	Code	Name	Function
1	04(04h)	read holding registers	Reading multiple registers
2	06(06h)	preset single register	Writing registers*1
3	16(10h)	preset multiple registers	Writing multiple registers

\*1 : Broadcast is not supported.

## 3.10 Checksum calculation method

### 3.10.1 LRC(ASCII)

LRC checks the content of the message other than [:] of START and [CR][LF] of END. The sending side calculates and sets. The receiving side calculates based on the received message, and compares the calculation result with the received LRC. The received message is deleted if the calculation result and received LRC do not match. Consecutive 8 bits of the message are added, and the result without carry (overflow) is converted to 2's complement.

#### ■ Calculation example

Example) Change circulating fluid set temperature 23.4 ° C

Sending data 0106004000EA

○Slave Address : No.1

○Function : No.06

○Writing address : 0040h

○Writing data : 00EAh

No	Classification	Contents	calculation result
1	LRC message for calculation	0106004000EA	-
2	Calculation	Added for each 8Byte 01h+06h+00h+40h+00h+EAh=131h	31h
3		complement of 2 31h→CEh→CFh	CFh(LRC)
4	Sending message	[:]0106004000EACF[CR][LF]	-

### 3.10.2 CRC(RTU)

CRC checks the content of the message. The sending side calculates the data every 2 bytes (16 bits). The receiving side calculates CRC based on the received message, and compares the calculation result with the received CRC. The received message is deleted if the calculated CRC is different from the received CRC.

■ **Calculation procedure**

- (1) Preload “FFFFh” (set 0xFFFF as initial value ).
- (2) Exclusive OR the first byte of the transmitted message with the value in (1).
- (3) Shift the result of (2) by one bit toward the least significant bit, and fill a zero into the most significant bit position.
- (4) If the least significant bit was a 1, exclusive OR the result of (3) with “A001h”. (Example 1). If the least significant bit was a 0, no exclusive OR takes place.
- (5) Repeat (3) to (5) until eight shifts have been performed.S
- (6) After eight shifts, exclusive OR the result of (5) with the next 1-byte (2nd. byte).
- (7) The processes (3) to (6) are repeated for all the remaining bytes of the message.
- (8) The 2-byte data of the result of (7) is the CRC value

(Example 1) The least significant bit was a 1.

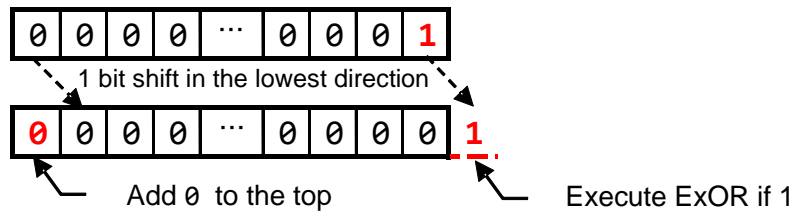

(Example 2) The least significant bit was a 0.

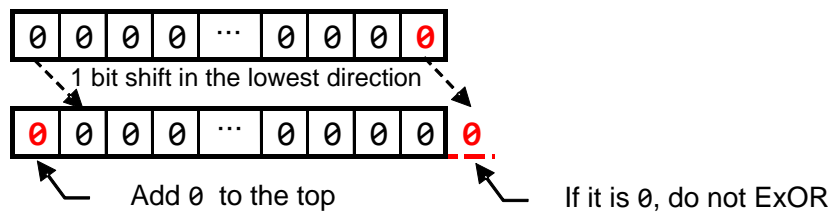

■ **Calculation example**

Example) Change circulating fluid set temperature 23.4 ° C

Sending data 0106004000EA

○Slave Address : No.1

○Function : No.06

○Writing address : 0040h

○Writing data : 00EAh

Data No.	1st value	2nd value	3rd value	4th value	5th value	6th value
Data contents	0001h	0006h	0000h	0040h	0000h	00EAh

No	Classification	Contents	Result
1	CRC message for calculation	0106000B00FE	-
2	Calculation	Perform (1) to (4) for the 1st value (0001h) and then, perform (5).	807Eh
3		Perform (6) for 2nd value (0006h) and then, perform (5).	2280h
4		Perform (6) for 3rd. value (0000h) and then, perform (5).	A023h
5		Perform (6) for 4th value (0040h) and then, perform (5).	29E0h
6		Perform (6) for 5th value (0000h) and then, perform (5).	8828Eh
7		Perform (6) for 6th value (00EAh) and then, perform (5).	9109h (CRC)
8	Addition to the sent message	0106004000EA0991*1	-

**\*1 When incorporating it into the message, set it in order of low byte and high byte.**

## 3.11 Explanation of function codes

### 3.11.1 Function code : 04 Reading multiple registers

Register data of assigned points from assigned address is read.

#### ■ Communication example

○Slave Address : No.1

○Read 16 pieces data from register 0030h.

- CH1 Circulating fluid discharge temperature [20.0°C]
- CH2 Circulating fluid discharge temperature [25.0°C]
- CH1 Circulating fluid electrical conductivity [20.0uS/cm] \*1
- CH2 Circulating fluid electrical conductivity [20.0uS/cm]
- CH1 Circulating fluid discharge pressure [45MPa]
- CH2 Circulating fluid discharge pressure [0.50MPa]
- CH1 Circulating fluid flow rate [45.0LPM]
- CH2 Circulating fluid flow rate [10.0LPM]
- Data display 1 to 4 [non-selection (all 0)]
- Status flag [during operation, CH1, CH2 TEMP READY status]
- Alarm flag 1 to 3 [no alarm]

\*1 "0" is displayed except for option D1.

Request message 010400300010			
Field name	Example (HEX)	ASCII mode character data	RTU mode binary data
Header	-	“.”	None
Slave Address	0x01	“0”, “1”	0x01
Function	0x04	“0”, “4”	0x04
Head address of specified register	0x0030	“0”, “0”, “3”, “0”	0x00, 0x30
Quantity of register to read	0x0010	“0”, “0”, “1”, “0”	0x00, 0x10
Checksum ASCII:LRC RTU:CRC	-	“B”, “B”	0xF1, 0xC9
Trailer	-	CR/LF	None
	Total quantity of byte	17	8



Response message 01042000C800FA00C800C8002D003201C2006400000000000000000031000000000000			
Field name	Example (HEX)	ASCII mode character data	RTU mode binary data
Header	-	“:”	None
Slave Address	0x01	“0”, “1”	0x01
Function	0x04	“0”, “4”	0x04
Quantity of bytes to read	0x20	“2”, “0”	0x20
Information of 0030h (CH1 Circulating fluid discharge temperature)	0x00C8	“0”, “0”, “C”, “8”	0x00, 0xC8
Information of 0031h (CH2 Circulating fluid discharge temperature)	0x00FA	“0”, “0”, “F”, “A”	0x00, 0xFA
Information of 0032h (CH1 Circulating fluid electrical conductivity)*1	0x00C8	“0”, “0”, “C”, “8”	0x00, 0xC8
Information of 0033h (CH2 Circulating fluid electrical conductivity)	0x00C8	“0”, “0”, “C”, “8”	0x00, 0xC8
Information of 0034h (CH1 Circulating fluid discharge pressure)	0x002D	“0”, “0”, “2”, “D”	0x00, 0x2D
Information of 0035h (CH2 Circulating fluid discharge pressure)	0x0032	“0”, “0”, “3”, “2”	0x00, 0x32
Information of 0036h (CH1 Circulating fluid flow rate)	0x01C2	“0”, “1”, “C”, “2”	0x01, 0xC2
Information of 0037h (CH2 Circulating fluid flow rate)	0x0064	“0”, “0”, “6”, “4”	0x00, 0x64
Information of 0038h (Data display 1)	0x0000	“0”, “0”, “0”, “0”	0x00, 0x00
Information of 0039h (Data display 2)	0x0000	“0”, “0”, “0”, “0”	0x00, 0x00
Information of 003Ah (Data display 3)	0x0000	“0”, “0”, “0”, “0”	0x00, 0x00
Information of 003Bh (Data display 4)	0x0000	“0”, “0”, “0”, “0”	0x00, 0x00
Information of 003Ch (Status flag)	0x0031	“0”, “0”, “3”, “1”	0x00, 0x31
Information of 003Dh (Alarm flag 1)	0x0000	“0”, “0”, “0”, “0”	0x00, 0x00
Information of 003Eh (Alarm flag 2)	0x0000	“0”, “0”, “0”, “0”	0x00, 0x00
Information of 003Fh (Alarm flag 3)	0x0000	“0”, “0”, “0”, “0”	0x00, 0x00
Checksum ASCII:LRC RTU:CRC	-	“9”, “A”	0xE7, 0xB8
Trailer	-	CR/LF	None
	Total quantity of byte	75	37

\*1 "0" is displayed except for option D1.

### 3.11.2 Function code : 06 Writing registers

Write data to assigned address.

■ **Communication example**

○ Slave Address : No.1

○ Write data to register 0042Ch  
 (The mode request indication)

Request message 010600420002			
Field name	Example (HEX)	ASCII mode character data	RTU mode binary data
Header	-	“.”	None
Slave Address	0x01	“0”, “1”	0x01
Function	0x06	“0”, “6”	0x06
Head address of specified register	0x0042	“0”, “0”, “4”, “2”	0x00, 0x42
Information written to 0042h (Mode request)	0x0002	“0”, “0”, “0”, “2”	0x00, 0x02
Checksum ASCII:LRC RTU:CRC	-	“B”, “5”	0xA8, 0x1F
Trailer	-	CR/LF	None
-	Total quantity of byte	17	8

Response message 010600420002			
Field name	Example (HEX)	ASCII mode character data	RTU mode binary data
Header	-	“.”	None
Slave Address	0x01	“0”, “1”	0x01
Function	0x06	“0”, “6”	0x06
Address of register to write	0x0042	“0”, “0”, “4”, “2”	0x00, 0x42
Information of register to write	0x0002	“0”, “0”, “0”, “2”	0x00, 0x02
Checksum ASCII:LRC RTU:CRC	-	“B”, “5”	0xA8, 0x1F
Trailer	-	CR/LF	None
-	Total quantity of byte	17	8

### 3.11.3 Function code : 16 Writing multiple registers

Register content of assigned points of assigned address is written.

#### ■ Communication example

○Slave Address : No.1

○Write three consecutive data from register 0040h.

- CH1 Change of circulating fluid set temperature [23.5°C]
- CH2 Change of circulating fluid set temperature [34.9°C]
- Operation start instruction

Request message 0110004000030600EB015D0001			
Field name	Example (HEX)	ASCII mode character data	RTU mode binary data
Header	-	“.”	None
Slave Address	0x01	“0”, “1”	0x01
Function	0x10	“1”, “0”	0x10
Head address of specified register	0x0040	“0”, “0”, “4”, “0”	0x00,0x40
Quantity of register to write	0x0003	“0”, “0”, “0”, “3”	0x00,0x03
Quantity of byte to write	0x06	“0”, “6”	0x06
Information written to 0040h (CH1 Circulating fluid set temperature)	0x00EB	“0”, “0”, “E”, “B”	0x00,0xEB
Information written to 0041h (CH2 Circulating fluid set temperature)	0x015D	“0”, “1”, “5”, “D”	0x01,0x5D
Information written to 0042h (Operation stop flag)	0x0001	“0”, “0”, “0”, “1”	0x00,0x01
Checksum ASCII:LRC RTU:CRC	-	“5”, “C”	0x91,0xAD
Trailer	-	CR/LF	None
	Total quantity of byte	31	15

Response message 011000400003			
Field name	Example (HEX)	ASCII mode character data	RTU mode binary data
Header	-	“.”	None
Slave Address	0x01	“0”, “1”	0x01
Function	0x10	“1”, “0”	0x10
Head address of register to write	0x0040	“0”, “0”, “4”, “0”	0x00,0x40
Quantity of register to write	0x0003	“0”, “0”, “0”, “3”	0x00,0x03
Checksum ASCII:LRC RTU:CRC	-	“A”, “C”	0x81,0xDC
Trailer	-	CR/LF	None
	Total quantity of byte	17	8

## 3.12 Negative response

A negative response is returned when the following request message is received.

- 1) When unspecified function code is used.
- 2) An address out of range is specified.
- 3) The data field is not normal.

### ■ Negative response message (Slave to Master)

1) Negative acknowledgment message frame in ASCII mode.

Start	Slave Address	1)Function	2)Error Code	LRC	End
[:]	XX   XX	XX   XX	XX   XX	XX   XX	[CR]   [LF]

2) Negative acknowledgment message frame in RTU.

Start	Slave Address	1)Function	2)Error Code	CRC	End
T1-T2-T3-T4 *1	XX	XX	XX   XX	XX   XX	T1-T2-T3-T4 *1

**\*1 Silent interval for 3.5 characters**

1) Function

Assign the value consisting of the request function code (hexadecimal value) plus 80h.

Example 1) ASCII mode

Received function code: "04"(0000 0100)" ASCII code 30h, 34h  
 Abnormal function code: "84" (1000 0100) " ASCII code 38h, 34h

Example 2) RTU mode

Receive function code: "04" (0000 0100)  
 Abnormal function code: "84" (1000 0100)

2) Error Code

Assign error code below.

- 01 : Function code of a command is outside the standard
- 02 : The specified address of register is outside the range.
- 03 : Data field of a command is not normal.

■ **Communication example**

○ Slave Address : No 1

○ Read seven consecutive data from register 0100h which is out of range.

Request message 010401000007			
Field name	Example (HEX)	ASCII mode character data	RTU mode binary data
Header	-	“.”	None
Slave Address	0x01	“0”, “1”	0x01
Function	0x04	“0”, “4”	0x04
Head address of register out of range	0x0100	“0”, “1”, “0”, “0”	0x01, 0x00
Quantity of register to read	0x0007	“0”, “0”, “0”, “7”	0x00, 0x07
Checksum ASCII:LRC RTU:CRC	-	“F”, “3”	0xB0, 0x34
Trailer	-	CR/LF	None
	Total quantity of byte	16	8

Response message 018402			
Field name	Example (HEX)	ASCII mode character data	RTU mode binary data
Header	-	“.”	None
Slave Address	0x01	“0”, “1”	0x01
Function (03h+80h)	0x84	“8”, “4”	0x84
Error Code (Specified register address is out of range.)	0x02	“0”, “2”	0x02
Checksum ASCII:LRC RTU:CRC	-	“7”, “9”	0xC2, 0xC1
Trailer	-	CR/LF	None
	Total quantity of byte	11	5

### 3.13 Register Map

Address	Contents	value	R/W
0030h	CH1 Circulating fluid discharge temperature	Decimal number : -327.6 to 327.6°C Hexadecimal number : F334h to 0CCCh (0.1°C/dig)	R
0031h	CH2 Circulating fluid discharge temperature	Decimal number : -327.6 to 327.6°C Hexadecimal number : F334h to 0CCCh (0.1°C/dig)	
0032h	CH1 Circulating fluid electrical conductivity *5	Decimal number : -3276.8 to 3276.7μS/cm Hexadecimal number : 8000h to 7FFFh (0.1μS/cm/dig)	
0033h	CH2 Circulating fluid electrical conductivity	Decimal number : -3276.8 to 3276.7μS/cm Hexadecimal number : 8000h to 7FFFh (0.1μS/cm/dig)	
0034h	CH1 Circulating fluid discharge pressure	Decimal number : -32.76 to 32.76MPa Hexadecimal number : F334h to 0CCCh (0.01MPa/dig)	
0035h	CH2 Circulating fluid discharge pressure	Decimal number : -32.76 to 32.76MPa Hexadecimal number : F334h to 0CCCh (0.01MPa/dig)	
0036h	CH1 Circulating fluid flow rate	Decimal number : -3276.8 to 3276.7LPM Hexadecimal number : 8000h to 7FFFh] (0.1LPM/dig)	
0037h	CH2 Circulating fluid flow rate	Decimal number : -3276.8 to 3276.7LPM Hexadecimal number : 8000h to 7FFFh (0.1LPM/dig)	
0038h	Data display 1	Follow the data instructions *1	
0039h	Data display 2	Follow the data instructions *1	
003Ah	Data display 3	Follow the data instructions *1	
003Bh	Data display 4	Follow the data instructions *1	
003Ch	Status flag	Refer to 3.13.5 Status flag	
003Dh	Alarm flag 1	Refer to 3.13.6 Alarm flag	
003Eh	Alarm flag 2	Refer to 3.13.6 Alarm flag	
003Fh	Alarm flag 3	Refer to 3.13.6 Alarm flag	
0040h	CH1 Circulating fluid set temperature	Positive number : 0000h to 7FFFh(0.1°C/dig) Negative number : 8000h to FFFFh(0.1°C/dig) *2	R/W
0041h	CH2 Circulating fluid set temperature	Positive number : 0000h to 7FFFh(0.1°C/dig) Negative number : 8000h to FFFFh(0.1°C/dig) *2	
0042h	Operation instruction	*3(Operation start instruction, mode request, alarm reset)	
0043h	Data instruction	*4	

- \* 1 Data display(Refer to 3.13.7 Data display)
- \* 2 Negative numbers are two's complement representation
- \* 3 Operation instruction(Refer to 3.13.9 Operation instruction)
- \* 4 Data instruction(Refer to 3.13.10 Data instruction)
- \*5 "0" is displayed except for option D1.

### **3.13.1 Circulating fluid discharge temperature**

To notify the circulating fluid discharge temperature of the product. (°C or °F). Read the circulating fluid discharge temperature which is displayed on the touch panel. (Offset temperature is displayed if offset function is set).

### **3.13.2 Circulating fluid electrical conductivity**

Notifies the circulating fluid electrical conductivity(CH2 only).

### **3.13.3 Circulating fluid discharge pressur**

To notify the circulating fluid discharge pressure of the product.

### **3.13.4 Circulating fluid flow rate**

To notify the circulating fluid discharge pressure of the product..

### 3.13.5 Status flag

The status of the product is read by the following assignment.

**Status flag**

Name	Status flag															
Bit	15	14	13	12	11	10	9	8	7	6	5	4	3	2	1	0

Bit	Name	Explanation
0	Run flag	Run status 0= Stop 1= Run
1	Operation stop alarm flag	Operation stop alarm given off status 0= Not occurred 1= Operation stop alarm given off
2	Operation continued alarm flag	Operation continued alarm given off status 0= Not occurred 1= Operation continued alarm given off
3	Notice for maintenance	Notice for maintenance status 0 = Not generated 1 = Generated
4	CH1 Completion of preparation (TEMP READY)flag	Completion of preparation (TEMP READY) status 0= Condition isn't formed 1= Condition is formed
5	CH1 Completion of preparation (TEMP READY)flag	Completion of preparation (TEMP READY) status 0= Condition isn't formed 1= Condition is formed
6	TEMP OUT flag	TEMP OUT status 0= Condition isn't formed 1= Condition is formed
7	None	—
8	None	—
9	None	—
10	None	—
11	None	—
12	External tuning function flag	External tuning function setting states 0=Stop 1= During setting
13	Warm-up function flag	Warm-up function setting status 0= Unset 1= During setting
14	Startup operation flag	Startup operation setting status 0= Unset 1= During setting
15	Anti-freezing flag	Anti-freezing setting status 0= Unset 1= During setting



### 3.13.6 Alarm flag

Each type of alarm which occurs in the product is read with the following assignment.

Name	Alarm flag 1															
Bit	15	14	13	12	11	10	9	8	7	6	5	4	3	2	1	0

Name	Alarm flag 2															
Bit	15	14	13	12	11	10	9	8	7	6	5	4	3	2	1	0

Bit	Name	Explanation	
Alarm flag 1	0	CH1 abnormal low tank fluid level	Alarm given off status 0= Not occurred 1= Occurred
	1	CH1 low tank fluid level	
	2	CH2 Abnormal low tank fluid level	
	3	CH2 low tank fluid level	
	4	Reservation	
	5	Fan failure *1	
	6	Air exhaust fan failure *2	
	7	Reservation	
	8	CH1 abnormal rise of circulating fluid temperature	
	9	CH1 circulating fluid temperature rise	
	10	CH1 circulating fluid temperature drop	
	11	CH1 TEMP READY alarm	
	12	CH2 abnormal rise of circulating fluid temperature	
	13	CH2 circulating fluid temperature rise	
	14	CH2 circulating fluid temperature drop	
15	CH2 TEMP READY alarm		
Alarm flag 2	0	CH1 abnormal rise in heat exchanger inlet temperature	
	1	CH1 failure of circulating fluid discharge pressure sensor	
	2	CH1 circulating fluid discharge pressure rise	
	3	CH1 circulating fluid discharge pressure drop	
	4	CH2 abnormal rise in heat exchanger inlet temperature	
	5	CH2 failure of circulating fluid discharge pressure sensor	
	6	CH2 circulating fluid discharge pressure rise	
	7	CH2 circulating fluid discharge pressure drop	
	8	CH2 abnormal drop in circulating fluid discharge pressure	
	9	CH2 failure of circulating fluid discharge flow sensor	
	10	CH2 electric conductivity increase	
	11	CH1 electric conductivity increase	
	12	Reservation	
	13	Contact input signal 1 detection	
	14	Contact input signal 2 detection	
15	Reservation		

Alarm flag 3	0	CH2 Low Flow FLT	Alarm given off status 0= Not occurred 1= Occurred
	1	Communication error	
	2	Outside of the ambient temperature range	
	3	Maintenance alarm	
	4	Compressor circuit failure	
	5	Sensor failure	
	6	Controller failure	
	7	Compressor inverter error	
	8	Compressor inverter communication error	
	9	CH1 pump inverter error	
	10	CH1 pump inverter communication error	
	11	CH2 pump inverter error	
	12	CH2 pump inverter communication error	
	13	Reservation	
	14	Reservation	
15	Reservation		

\*3 For Air-cooled refrigerated type model only.

\*4 For Water-cooled refrigerated type model only.

### 3.13.7 Data display

The contents selected in the data instruction will be displayed on the data display 1 to 4. Table below shows the data type which can be displayed and the range.

No.	Item	Range
0	None	0
1	Ambient temperature	Decimal number : -327.6 to 327.6°C Hexadecimal number : F334h to 0CCCh (0.1°C/dig)
2	External tuning temperature *	Decimal number : -327.6 to 327.6°C Hexadecimal number : F334h to 0CCC (0.1°C/dig)
3	CH1 heat exchanger inlet temperature	Decimal number : -327.6 to 327.6°C Hexadecimal number : F334h to 0CCCh (0.1°C/dig)
4	Notice for maintenance	Occurrence status of each maintenance 0= Not occurred 1= Occurred
5	Pressure of high pressure refrigerant circuit	Decimal number : -32.76 to 32.76MPa Hexadecimal number : F334h to 0CCCh (0.01MPa/dig)

\* When the external tuning function is OFF, it will be -327.6 °C (F334h) fixed.

### 3.13.8 Circulating fluid set temperature

In SERIAL mode, you can set the circulating fluid set temperature of this product by specifying the circulating fluid set temperature. If the temperature exceeds the upper limit of the circulating fluid set temperature range, the circulating fluid set temperature is changed to the upper limit value. If it is lower than the lower limit, the circulating fluid set temperature is changed to the lower limit value.

### 3.13.9 Operation instruction

Name	Operation instruction															
Bit	15	14	13	12	11	10	9	8	7	6	5	4	3	2	1	0

Bit	Name	Explanation
0	Operation Start Command	Operation Start /Stop 0= Operation Stop 1= Operation Start
1	Mode request flag	Mode request 0= None 1= Yes
2	Alarm reset flag	Alarm reset 0= None 1= Yes
3 to15	None	-

#### Operation Start Command

SERIAL mode, you can control the operation start / stop of this product. However, this function is invalidated when the setting of "DIO Run / Stop" is ON on the touch panel.

#### Mode request flag

The mode request flag can be switched to the SERIAL mode is changed from 0 to 1. After that, even if it changes to 0, it keeps SERIAL mode.  
(For details, Refer to "1.2 Change of operation mode")

#### Alarm reset flag

Alarm reset can be performed by changing the alarm reset flag from 0 to 1 in SERIAL mode.

### 3.13.10 Data instruction

By setting the data instructions to display the data that you selected in each data display 1, 2, 3, 4.

The types of data that can be displayed are shown below.

Data display 1 displays data of the type instructed in data instruction 1 (data instruction 0-3 bits), data display 2 data instruction 2 (data instruction high 5-7 bits), data display 3 data instruction 3 (data instruction high Data display 4 displays data of the type specified in data indication 4 (upper 12-15 bits of data indication).

Name	Data instruction 4				Data instruction 3				Data instruction 2				Data instruction 1			
Bit	15	14	13	12	11	10	9	8	7	6	5	4	3	2	1	0

Numeric value		Description
Data instruction 1	0	None
	1	Ambient temperature
	2	External tuning temperature
	3	CH1 heat exchanger inlet temperature
	4	Notice for maintenance
	5	Pressure of high pressure refrigerant circuit
Data instruction 2	0	None
	1	Ambient temperature
	2	External tuning temperature
	3	CH1 heat exchanger inlet temperature
	4	Notice for maintenance
	5	Pressure of high pressure refrigerant circuit
Data instruction 3	0	None
	1	Ambient temperature
	2	External tuning temperature
	3	CH1 heat exchanger inlet temperature
	4	Notice for maintenance
	5	Pressure of high pressure refrigerant circuit
Data instruction 4	0	None
	1	Ambient temperature
	2	External tuning temperature
	3	CH1 heat exchanger inlet temperature
	4	Notice for maintenance
	5	Pressure of high pressure refrigerant circuit

■ **Communication example**

- When reading the ambient temperature to the data display 1
- Slave Address : No.1
- Function code 6 : Write one data to 0043 h  
(Set ambient temperature to data instruction 1.)

Request message 010600430001			
Field name	Example (HEX)	ASCII mode character data	RTU mode binary data
Header	-	“:”	None
Slave Address	0x01	“0”, “1”	0x01
Function	0x06	“0”, “6”	0x06
Address of the specified register	0x0043	“0”, “0”, “4”, “3”	0x00, 0x43
Information written to 0043h (Data instruction)	0x0001	“0”, “0”, “0”, “1”	0x00, 0x01
Checksum ASCII:LRC RTU:CRC	-	“B”, “5”	0xB9, 0xDE
Trailer	-	CR/LF	None
-	Total quantity of byte	17	8

Response message 010600430001			
Field name	Example (HEX)	ASCII mode character data	RTU mode binary data
Header	-	“:”	None
Slave Address	0x01	“0”, “1”	0x01
Function	0x06	“0”, “6”	0x06
Address of register to write	0x0043	“0”, “0”, “4”, “3”	0x00, 0x43
Information of register to write	0x0001	“0”, “0”, “0”, “1”	0x00, 0x01
Checksum ASCII:LRC RTU:CRC	-	“B”, “5”	0xB9, 0xDE
Trailer	-	CR/LF	None
-	Total quantity of byte	17	8

- Function code 4 : Read one data of 0038 h  
(Read out the ambient temperature of data display 1.)

Request message 010400380001			
Field name	Example (HEX)	ASCII mode character data	RTU mode binary data
Header	-	“:”	None
Slave Address	0x01	“0”, “1”	0x01
Function	0x04	“0”, “4”	0x04
Head address of specified register	0x0038	“0”, “0”, “3”, “8”	0x00, 0x38
Quantity of register to read	0x0001	“0”, “0”, “0”, “1”	0x00, 0x01
Checksum ASCII:LRC RTU:CRC	-	“C”, “2”	0xB0, 0x07
Trailer	-	CR/LF	None
	Total quantity of byte	17	8

Response 01040200FA			
Field name	Example (HEX)	ASCII mode character data	RTU mode binary data
Header	-	“:”	None
Slave Address	0x01	“0”, “1”	0x01
Function	0x04	“0”, “4”	0x04
Quantity of bytes to read	0x02	“0”, “2”	0x02
Information of 0038h (Data display 1)	0x00FA	“0”, “0”, “F”, “A”	0x00, 0xFA
Checksum ASCII:LRC RTU:CRC	-	“F”, “F”	0x39, 0x73
Trailer	-	CR/LF	None
	Total quantity of byte	15	7

\* Response message at an ambient temperature of 25.0°C

# Chapter 4 Communication alarm function

Monitors whether the serial communication is sent/received properly between the product and the customer's device. This feature is only valid when the operation mode is set to SERIAL mode.

Abnormal signals or disconnection of the communication cable can be notified immediately by setting the alarm function to match the interval at which messages are sent from the customer device. When the communication is restored, the alarm is automatically reset.

Do not use this function when the customer device does not send messages regularly.

## 4.1 Communication alarm occurs

Fig 4-1 shows when an alarm occurs. Refer to 4.3 for the setting method.

- Communication alarm

Operation continues when an alarm occurs.

- Time for monitoring the communication alarm

180 sec

When the customer's device is sending messages every 60sec, if the communication cable is disconnected and no message is received for 180sec, the product generates AL34 communication error alarm to notify the error.

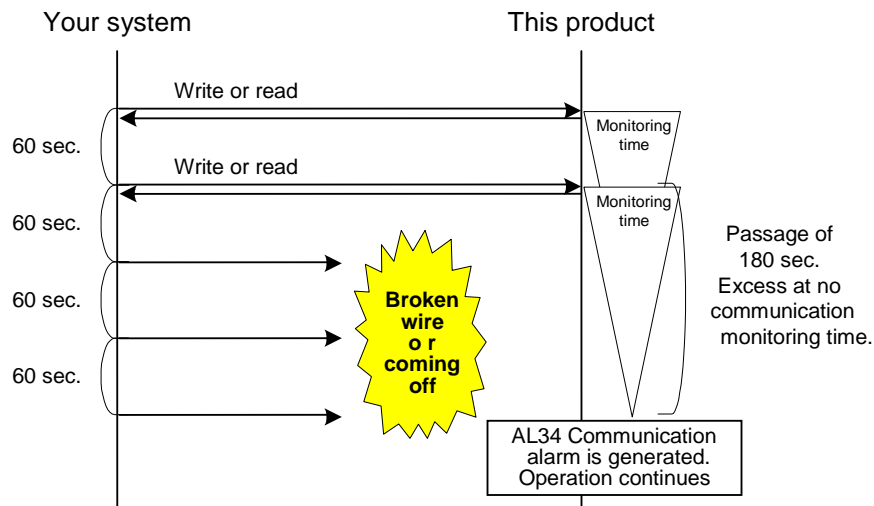

Fig. 4-1 Communication alarm example

## 4.2 Communication alarm reset

When AL34 communication error has been generated, the alarm is automatically reset when the disconnection of the communication cable is fixed, and the message from the customer is received. If operation is set to stop when a communication alarm occurs, restart the operation if necessary.

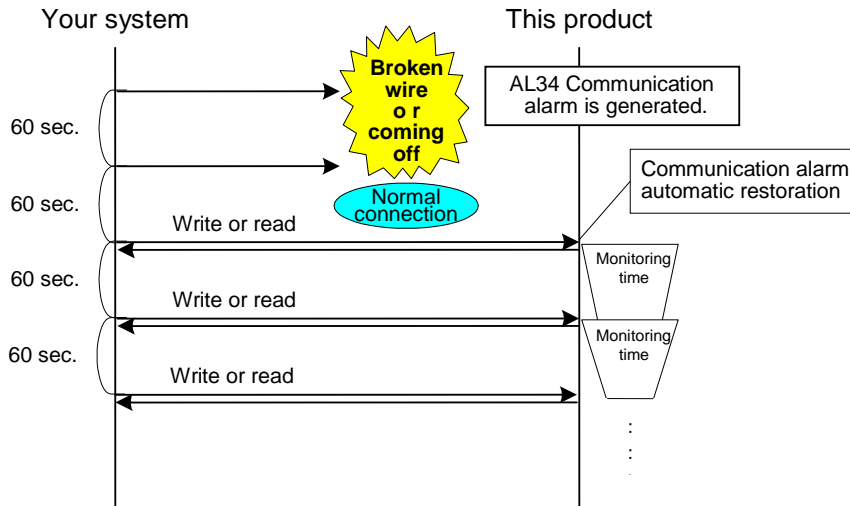
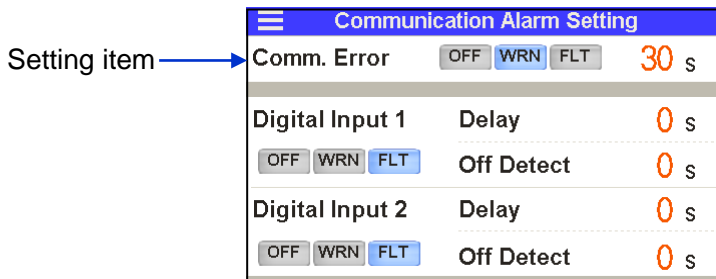

Fig. 4-2 Communication alarm restoration example

## 4.3 Setting method

Set of serial communication is done from “1.4 Touch panel flow” (Refer to “2. Serial communication settings” screen).



Indication	Item	Setting and selection		Setting range	
Comm. Error	Alarm “AL34 : Communication error”	<input type="button" value="OFF"/>	Disabled	Communication alarm detection time *1	30 to 600sec *30sec
		<input type="button" value="WRN"/> *	Operation continues during the alarm		
		<input type="button" value="FLT"/>	Operation stops during alarm		

\* By default

\* 1 : Time from communication error to alarm occurrence (monitoring time)



# Chapter 5 Ethernet Modbus / TCP communication

Remote control of the operation and temperature setting as well as acquisition of detailed product conditions and alarms can be remotely performed with Ethernet Modbus / TCP communication.

The operating state of the product (run/stop) and the temperature setting can be monitored by sending a request message made by the program of a higher level computer (e.g. PC).

The communication protocol is Modbus / TCP protocol.

## 5.1 Request for taking measures for information security

To ensure the security, take measures that are applicable to the user's operating system.

With the network connection, protect the system with a firewall.

No warranty is applied to any damage caused by network security issues such as unauthorized access.

One example of the information security is described below. Discuss the network security measures with the network administrator and decide what measures to take.

- Use in a system protected by a firewall.
- Install anti-virus software to the PC connected to the network.
- Acquire and monitor log information.
- Use in a system where direct access via the Internet is not allowed to prevent unauthorized access from outside.
  
- Use in a system where only authorized personnel can access.
- Do not use unsecured removal disks such as USB memory.

## 5.2 Precautions for wiring communication

○ Communication wiring

Communication cables that are used for connecting the product to user's equipment are not included. Use the following cables.

• 100BASE-TX

Shielded twisted pair cable (STP) or non-shielded twisted pair cable (UTP) with category 5 or more

• 10BASE-T

Shielded twisted pair cable (STP) or non-shielded twisted pair cable (UTP) with category 3 or more

\* Use straight cables for the twisted pair cable.

## 5.3 Connected explanation

Fig. 5-1. Shows the connection with customer equipment.

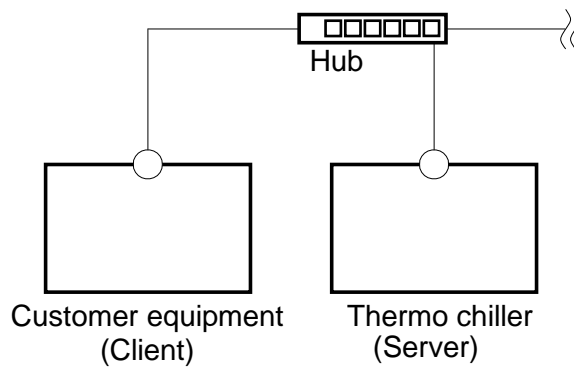

Fig. 5-1 Connection with the base

**[One Point]**

- Connect Thermo chiller with the base device via a hub. Cables, connectors and hub shall comply with the IEEE802.3 10BASE-T/100BASE-TX standard.
  - Up to 4 customer devices can be connected at the same time.
-

## 5.4 Communication specification

Table 5.4-1 Ethernet Modbus/TCP communication specification

Item	Specification
Connector type (for the product)	RJ45
Communication style	Ethernet
Data transfer method	100BASE-TX/10BASE-T
Protocol	Modbus/TCP*1

\*1: Refer to Modicon Co. protocol specifications "PI-MBUS-300 Rev.J".

Table 5.4-2 Ethernet Modbus/TCP communication Parameter

Item	Setting range	Initial value
IP Address	0.0.0.0~223.255.255.255	192.166.0.40
Subnet mask	0.0.0.0~255.255.255.255	255.255.255.0
Default gateway *1	0.0.0.0~255.255.255.255	0.0.0.0
Port No.	—	502

\*1: When default gateway is not used, the value should be set to 0.0.0.0.

## 5.5 Modbus/TCP communication function

Modbus protocol is a communication protocol developed by Modicon. It is used to communicate with a PC or PLC.

Register content is read and written by this communication protocol.

This communication has the following features.

- Controls run/stop.
- Sets and reads the circulating fluid set temperature.
- Reads the circulating fluid discharge temperature.
- Reads the circulating fluid discharge pressure.
- Reads the circulating fluid flow rate.
- Reads the circulating fluid electric conductivity(CH2 only).
- Reads the condition of the product.
- Reads the alarm generating condition of the product.
- The operation mode can be switched to "SERIAL" mode.
- You can reset the alarm.

Refer to "5.12 Register Map" for the register of the product.

## 5.6 Precautions for communication

### 5.6.1 Precautions after wiring and before communication

- Check or set each communication setting using the touch panel.
  1. The communication parameter setting should be correct.
  2. The operation mode should be set to the Ethernet mode.  
(When the mode request flag is enabled, the mode will be switched to Ethernet mode. Refer to chapter 3.13.9.

Reading is available with other modes, but writing is only available with Ethernet mode.

- Check or set the communication parameters using the touch panel.

### 5.6.2 Precautions for communicating

- Allow a suitable interval between requests.

To send request messages in series, wait for a certain time after receiving a response message from the product before sending the next message.

- Retry (resend request message).

The response may not be returned due to noise. If no message is returned after sending a request message, resend the request message,

If necessary, send a read request message to check if it was written correctly.

When handling of the written request message is complete, a positive message is returned.

Send a read request message to confirm if the settings are written as required.

- Setting the circulating fluid set temperature

When the circulating fluid set temperature is written by communication, the data is stored in FRAM. When the product restarts, it is with the value which was set before the restart. The number of times it is possible to overwrite FRAM is limited. Data is only stored in FRAM when it receives a circulating fluid set temperature which is different from the previous temperatures. Please check how many times it is possible to overwrite FRAM, and avoid unnecessary changes of the circulating fluid set temperature during communication.

## 5.7 Setting method

Set the Ethernet communication in “1.4 Touch Panel Flow” (Refer to “7. Ethernet Modbus/TCP communication setting”).

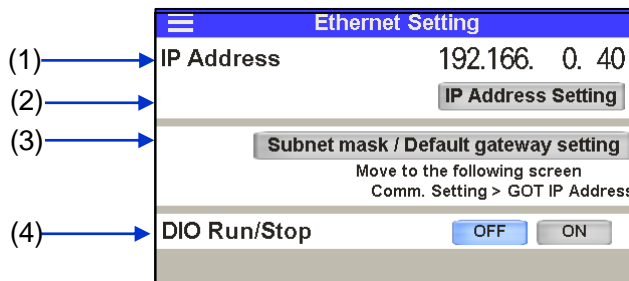

Ethernet Modbus/TCP communication setting

Table 3.6-1 Setting of serial communication

No.	Description	Items	Setting / selection / Display	
(1)	IP Address	IP Address	192.166.0.40 *1	Current value of IP address
(2)	IP Address Setting	IP Address Setting	<b>IP Address Setting</b>	
(3)	Subnet mask/ Default gateway setting	ubnet mask/ Default gateway setting	<b>Subnet mask / Default gateway setting</b>	
(4)	DIO Run/Stop *2	RUN / STOP by contact input.	<b>OFF</b> *1	Disabled
			<b>ON</b>	Enabled

\*1 : Factory default status

\*2 : RUN / STOP operation is performed by contact input signal and Change of the circulating fluid temperature set value and Operation conditions are written or read by Ethernet Modbus/TCP communication.

### 5.7.1 IP Address Setting

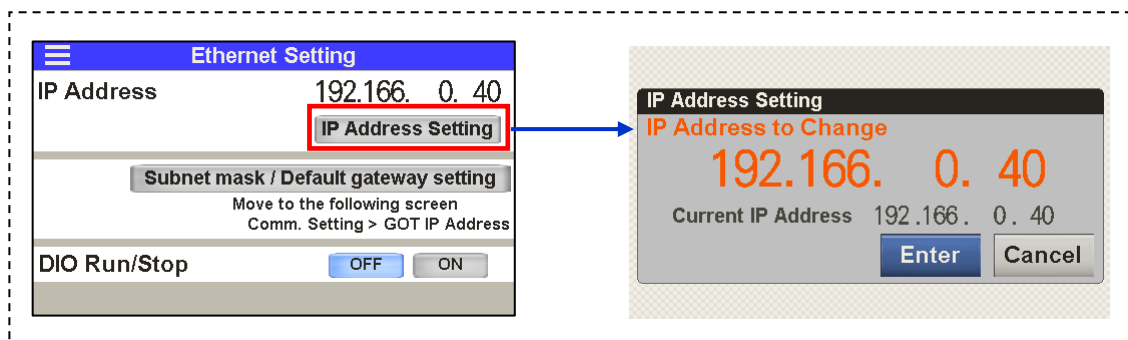

Set window is open by pressing **IP Address Setting**

Change the IP address and press the **Enter** button.

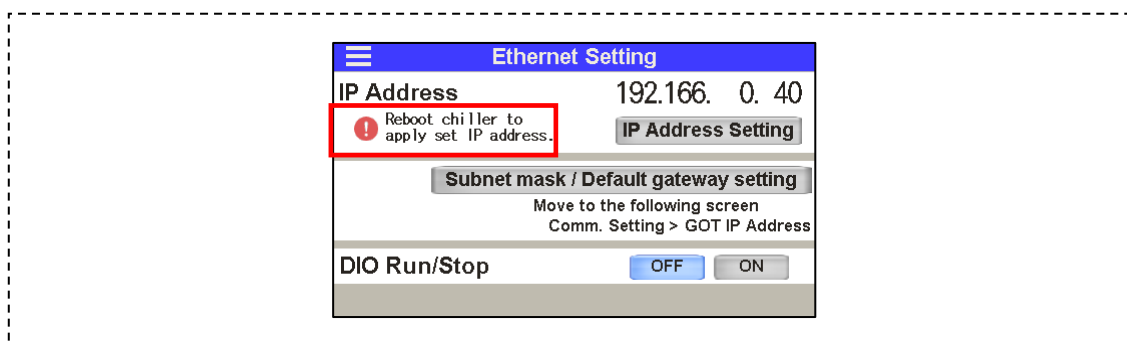

IP address will not change until the Thermo chiller is restarted.

After changing the IP address, turn off the power supply and restart Thermo chiller.

### 5.7.2 Setting of subnet mask and default gateway

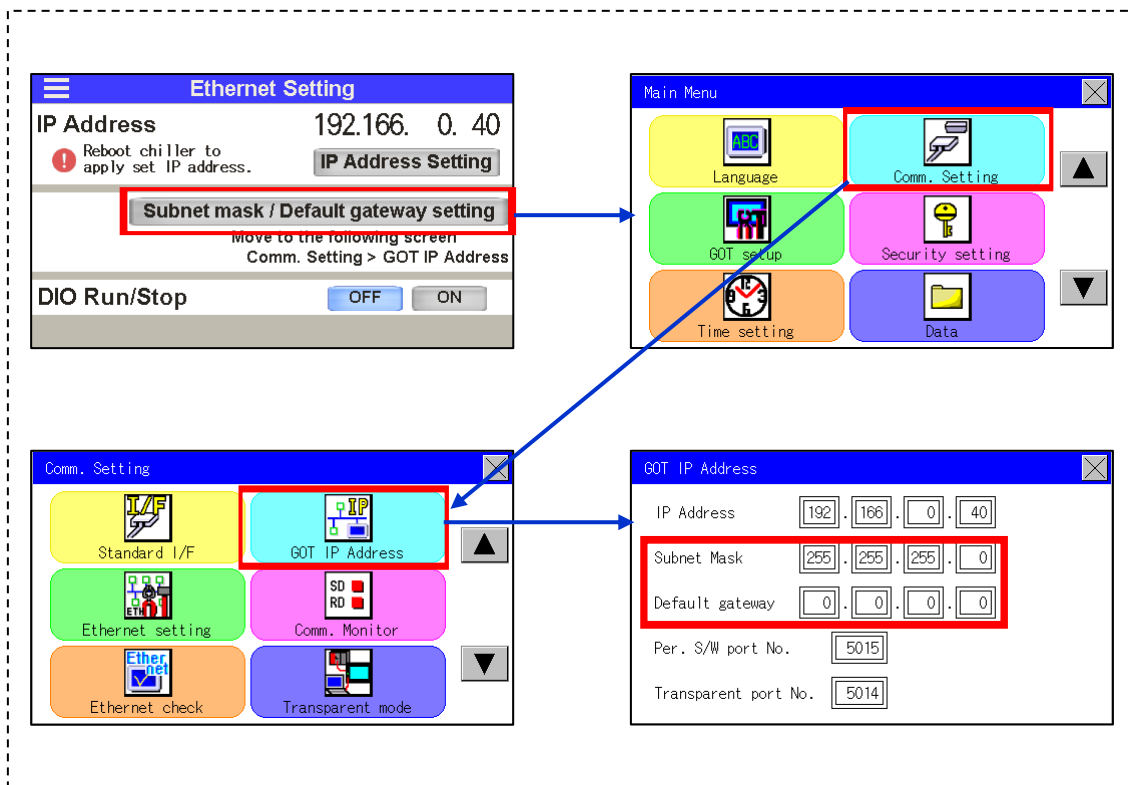

- When the setting of the subnet mask and default gateway are changed, the touch panel restarts.
- Setting of the subnet mask and default gateway should be performed when the operation is stopped.
- Change the setting of the subnet mask and default gateway only on the screen. Otherwise, Thermo chiller will not operate correctly.

## 5.8 Communication sequence

Modbus/TCP is the protocol in which the Modbus protocol is expanded to the TCP/IP. It is possible to communicate with messages in the Internet environment. Communication is performed with the Client Server Model. The client is equivalent to the base (customer equipment) of the existing Modbus protocol, so the server corresponds with the remote (Thermo chiller). Refer to the document, which is disclosed to the general users, for details of the communication sequence.

## 5.9 Message configuration

Fig. 5.9-1 shows the construction in which Request or Response are communicated in a capsule state on the Modbus/TCP network. Compared with the existing Modbus communication, the function code and data are common.

- Modbus ASCII / RTU (SERIALモード)



- Modbus / TCP (Ethernetモード)



Fig. 5.9-1 Comparison of Modbus and Modbus/TCP communication



- A) Transaction identifier : Transaction identifier (2byte)  
Copy the server. In general, all values are set to 0.
- B) Protocol identifier : All protocol identifiers (2byte)  
are set to 0.
- C) Length field : Field length (2byte)  
  - Upper byte : fixed to 0. (As all messages are 256byte or less)
  - Lower byte : Indicate the number of bytes afterwards.
- D) Unit identifier : Unit identifier (1byte)  
This is equivalent to the existing Modbus communication remote address, but each device is identified by the IP address.
- E) Function (Refer to “5.10 Function codes”)  
Designate command.
- F) Data  
Specify the register address, quantity, reading and writing in accordance with Function.

\* In Modbus / TCP, checksum (CRC and LRC) field are not available. Data is checked by TCP/IP and Ethernet processing data.

## 5.10 Function codes

Function codes for reading or writing the register are shown below. Table 5.10-1 Refer to 5.11 Description of each function code for details.

Table 5.10-1 Function codes

NO	Code	Name	Function
1	04(04h)	read input registers	Read multiple registers
2	06(06h)	preset single register	Writing registers
3	16(10h)	preset multiple registers	Write multiple registers

## 5.11 Explanation of function codes

Refer to the common part, function code and data part, in "3.11 Explanation of function codes" for serial communication. ("Header", "Checksum" and "Trailer" are not required for Modbus / TCP communication. In addition, the "slave address" corresponds to the "Unit identifier" in Modbus / TCP, but this product identifies the fuselage by its IP address. Please refer to 5.12.11 for a concrete communication example. )

## 5.12 Register Map

Address	Contents	Value	R/W
0030h	CH1 Circulating fluid discharge temperature	Decimal number : -327.6 to 327.6°C Hexadecimal number : F334h to 0CCCh (0.1°C/dig)	R
0031h	CH2 Circulating fluid discharge temperature	Decimal number : -327.6 to 327.6°C Hexadecimal number : F334h to 0CCCh (0.1°C/dig)	
0032h	CH1 Circulating fluid electrical conductivity *5	Decimal number : -3276.8 to 3276.7μS/cm Hexadecimal number : 8000h to 7FFFh (0.1μS/cm/dig)	
0033h	CH2 Circulating fluid electrical conductivity	Decimal number : -3276.8 to 3276.7μS/cm Hexadecimal number : 8000h to 7FFFh (0.1μS/cm/dig)	
0034h	CH1 Circulating fluid discharge pressure	Decimal number : -32.76 to 32.76MPa Hexadecimal number : F334h to 0CCCh (0.01MPa/dig)	
0035h	CH2 Circulating fluid discharge pressure	Decimal number : -32.76 to 32.76MPa Hexadecimal number : F334h to 0CCCh (0.01MPa/dig)	
0036h	CH1 Circulating fluid flow rate	Decimal number : -3276.8 to 3276.7LPM Hexadecimal number : 8000h to 7FFFh] (0.1LPM/dig)	
0037h	CH2 Circulating fluid flow rate	Decimal number : -3276.8 to 3276.7LPM Hexadecimal number : 8000h to 7FFFh (0.1LPM/dig)	
0038h	Data display 1	Follow the data instructions *1	
0039h	Data display 2	Follow the data instructions *1	
003Ah	Data display 3	Follow the data instructions *1	
003Bh	Data display 4	Follow the data instructions *1	
003Ch	Status flag	Refer to 5.12.5 Status flag	
003Dh	Alarm flag 1	Refer to 3.13.6 Alarm flag	
003Eh	Alarm flag 2	Refer to 3.13.6 Alarm flag	
003Fh	Alarm flag 3	Refer to 3.13.6 Alarm flag	
0040h	CH1 Circulating fluid set temperature	Positive number : 0000h to 7FFFh(0.1°C/dig) Negative number : 8000h to FFFFh(0.1°C/dig) *2	R/W
0041h	CH2 Circulating fluid set temperature	Positive number : 0000h to 7FFFh(0.1°C/dig) Negative number : 8000h to FFFFh(0.1°C/dig) *2	
0042h	Operation instruction	*3(Operation start instruction, mode request, alarm reset)	
0043h	Data instruction	*4	
0044h   004Fh	Reserved	—	—

\* 1 Data display (Refer to 3.13.7 Data display)

\* 2 Negative numbers are two's complement representation

\* 3 Operation instruction (Refer to 3.13.9 Operation instruction)

\* 4 Data instruction (Refer to 3.13.10 Data instruction)

\* 5 "0" is displayed except for option D1.

Address	Details	Value	R/W
0050h   005Fh	Model	ASCII code max. 32 characters Refer to 5.12.11 Communication example.	R
0060h   0062h	Serial No.	ASCII code 5 characters Refer to 5.12.11 Communication example.	
0063h   0064h	Control board Program No.	10 decimal number: 0 to 4294967295 16 hexadecimal number: 00000000h to FFFFFFFFh 4 bytes (0063h upper level 0064h lower level)	
0065h	Control board Program version	10 decimal number: 0 to 65535 16 hexadecimal number: 0000h to FFFFh	
0066h   0067h	Display Program No.	10 decimal number: 0 to 4294967295 16 hexadecimal number: 00000000h to FFFFFFFFh 4 bytes (0063h upper level 0064h lower level)	
0068h	Display Program version	10 decimal number: 0 to 65535 16 hexadecimal number: 0000h to FFFFh	
0069h   006Fh	Reserved	—	

### 5.12.1 Circulating fluid discharge temperature

The communication content is the same as serial communication.  
Refer to 3.13.1.

### 5.12.2 Circulating fluid electrical conductivity

The communication content is the same as serial communication.  
Refer to 3.13.2.

### 5.12.3 Circulating fluid discharge pressur

The communication content is the same as serial communication.  
Refer to 3.13.3.

### 5.12.4 Circulating fluid flow rate

The communication content is the same as serial communication.  
Refer to 3.13.4.

### 5.12.5 Status flag

The communication content is the same as serial communication.  
Refer to 3.13.5.

### 5.12.6 Alarm flag

The communication content is the same as serial communication.  
Refer to 3.13.6.

### 5.12.7 Data display

In the Ethernet mode, the contents selected for Data instruction are displayed in Data display 1 to 4. The data types that can be displayed and their range are the same as for serial communication Refer to 3.13.7.

### 5.12.8 Circulating fluid set temperature

In Ethernet mode, you can set the circulating fluid set temperature of this product by specifying the circulating fluid set temperature. If the temperature exceeds the upper limit of the circulating fluid set temperature range, the circulating fluid set temperature is changed to the upper limit value. If it is lower than the lower limit, the circulating fluid set temperature is changed to the lower limit value.

### 5.12.9 Operation instruction

Name	Operation instruction															
Bit	15	14	13	12	11	10	9	8	7	6	5	4	3	2	1	0

Bit	Name	Explanation
0	Operation Start Command	Operation Start /Stop 0= Operation Stop 1= Operation Start
1	Mode request flag	Mode request 0= None 1= Yes
2	Alarm reset flag	Alarm reset 0= None 1= Yes
3 to15	None	-

#### Operation Start Command

Ethernet mode, you can control the operation start / stop of this product. However, this function is invalidated when the setting of "DIO Run / Stop" is ON on the touch panel.

#### Mode request flag

The mode request flag can be switched to the Ethernet mode is changed from 0 to 1. After that, even if it changes to 0, it keeps Ethernet mode.  
 (For details, Refer to "1.2 Change of operation mode")

#### Alarm reset flag

Alarm reset can be performed by changing the alarm reset flag from 0 to 1 in Ethernet mode.

### 5.12.10 Data instruction

In the Ethernet mode, selected data is displayed in the data instruction 1, 2, 3, 4 by assigning the data instruction.

For the data that can be displayed and the instruction method, refer to "3.13.10 Data instruction" of serial communication.

### 5.12.11 Product number

Reads the product number of this product.

#### ■ Communication example

- When reading the product number and serial number
- Unit identifier : 1
- Function code 04 : Read 19 consecutive data from register 005h.
  - Product number HRL300-A-40
  - Serial number: AA001

Required message010400500013		
Field name	Example (HEX)	Binary data
Unit identifier	0x01	0x01
Function	0x04	0x04
First address of the specified register	0x0050	0x00,0x50
Number of registers to be read	0x0013	0x00,0x13
—	Total quantity of byte	6

Request message		
01042648524C3330302D412D323020202020202020202020202020202020202020414130303120		
Field name	Example (HEX)	Binary data
Unit identifier	0x01	0x01
Function	0x04	0x04
Quantity of bytes to read	0x26	0x26
Information of 0050h (Product number 1, 2)	0x4852	0x48,0x52
Information of 0051h (Product number 3, 4)	0x4C33	0x4C,0x33
Information of 0052h (Product number 5, 6)	0x3030	0x30,0x30
Information of 0053h (Product number 7, 8)	0x2D41	0x2D,0x41
Information of 0054h (Product number 9, 10)	0x2D32	0x2D,0x32
Information of 0055h (Product number 11, 12)	0x3020	0x30,0x20
Information of 0056h (Product number 13, 14)	0x2020	0x20,0x20
Information of 0057h (Product number 15, 16)	0x2020	0x20,0x20
Information of 0058h (Product number 17, 18)	0x2020	0x20,0x20
Information of 0059h (Product number 19, 20)	0x2020	0x20,0x20
Information of 005Ah (Product number 21, 22)	0x2020	0x20,0x20
Information of 005Bh (Product number 23, 24)	0x2020	0x20,0x20
Information of 005Ch (Product number 25, 26)	0x2020	0x20,0x20
Information of 005Dh (Product number 27, 28)	0x2020	0x20,0x20
Information of 005Eh (Product number 29, 30)	0x2020	0x20,0x20
Information of 005Fh (Product number 31, 32)	0x2020	0x20,0x20
Information of 0060h (Product number 1, 2)	0x4141	0x41,0x41
Information of 0061h (Product number 3, 4)	0x3030	0x30,0x30
Information of 0062h (Product number 5, Reservation)	0x3120	0x31,0x20
—	Total quantity of byte	41



**5.12.12 Serial number**

Reads the serial number of the product. Refer to 5.12.11 Communication example.

**5.12.13 Control board program number**

Reads the program number of the product.

**5.12.14 Control board program version**

Reads the program version of the product.

**5.12.15 Display program number**

Reads the display program number of the product.

**5.12.16 Display program version**

Reads the display program version of the product.





Revision
Rev. D :JAN 2023

## SMC Corporation

4-14-1, Sotokanda, Chiyoda-ku, Tokyo 101-0021 JAPAN

Tel: + 81 3 5207 8249 Fax: +81 3 5298 5362

URL <https://www.smcworld.com>

---

Note: Specifications are subject to change without prior notice and any obligation on the part of the manufacturer.  
© 2023 SMC Corporation All Rights Reserved