



Operation Manual

PRODUCT NAME

Communication cable for controller setting kit

MODEL / Series / Product Number

LEC-W2A-C

SMC Corporation

Contents

1. Safety Instructions	2
2. Outline	4
3. Installation of driver	5
3.1 Automatic Installation	5
3.2 Manual Installation	6
4. ACT Controller Installation	10
4.1 Installation	10
4.2 Check of the Communication Port	10
4.3 Communication Setting	11
4.4 Functions of Each Mode	12



Controller Setting Kit

1. Safety Instructions

These safety instructions are intended to prevent hazardous situations and/or equipment damage. These instructions indicate the level of potential hazard with the labels of "Caution," "Warning" or "Danger." They are all important notes for safety and must be followed in addition to International Standards (ISO/IEC)*1), and other safety regulations.

*1) ISO 4414: Pneumatic fluid power -- General rules relating to systems.

ISO 4413: Hydraulic fluid power -- General rules relating to systems.

IEC 60204-1: Safety of machinery -- Electrical equipment of machines .(Part 1: General requirements)

ISO 10218: Manipulating industrial robots -Safety.

etc.



Caution

Caution indicates a hazard with a low level of risk which, if not avoided, could result in minor or moderate injury.



Warning

Warning indicates a hazard with a medium level of risk which, if not avoided, could result in death or serious injury.



Danger

Danger indicates a hazard with a high level of risk which, if not avoided, will result in death or serious injury.



Warning

1. The compatibility of the product is the responsibility of the person who designs the equipment or decides its specifications.

Since the product specified here is used under various operating conditions, its compatibility with specific equipment must be decided by the person who designs the equipment or decides its specifications based on necessary analysis and test results.

The expected performance and safety assurance of the equipment will be the responsibility of the person who has determined its compatibility with the product.

This person should also continuously review all specifications of the product referring to its latest catalog information, with a view to giving due consideration to any possibility of equipment failure when configuring the equipment.

2. Only personnel with appropriate training should operate machinery and equipment.

The product specified here may become unsafe if handled incorrectly.

The assembly, operation and maintenance of machines or equipment including our products must be performed by an operator who is appropriately trained and experienced.

3. Do not service or attempt to remove product and machinery/equipment until safety is confirmed.

1. The inspection and maintenance of machinery/equipment should only be performed after measures to prevent falling or runaway of the driven objects have been confirmed.
2. When the product is to be removed, confirm that the safety measures as mentioned above are implemented and the power from any appropriate source is cut, and read and understand the specific product precautions of all relevant products carefully.
3. Before machinery/equipment is restarted, take measures to prevent unexpected operation and malfunction.

4. Contact SMC beforehand and take special consideration of safety measures if the product is to be used in any of the following conditions.

1. Conditions and environments outside of the given specifications, or use outdoors or in a place exposed to direct sunlight.
2. Installation on equipment in conjunction with atomic energy, railways, air navigation, space, shipping, vehicles, military, medical treatment, combustion and recreation, or equipment in contact with food and beverages, emergency stop circuits, clutch and brake circuits in press applications, safety equipment or other applications unsuitable for the standard specifications described in the product catalog.
3. An application which could have negative effects on people, property, or animals requiring special safety analysis.
4. Use in an interlock circuit, which requires the provision of double interlock for possible failure by using a mechanical protective function, and periodical checks to confirm proper operation.



Controller Setting Kit Safety Instructions

Caution

The product is provided for use in manufacturing industries.

The product herein described is basically provided for peaceful use in manufacturing industries. If considering using the product in other industries, consult SMC beforehand and exchange specifications or a contract if necessary.
If anything is unclear, contact your nearest sales branch.

Limited warranty and Disclaimer/Compliance Requirements

The product used is subject to the following "Limited warranty and Disclaimer" and "Compliance Requirements".

Read and accept them before using the product.

Limited warranty and Disclaimer

1. Grant of license

1. This Software is to be used in accordance with this Agreement non-exclusively for the limited purpose of **writing** data to controllers for SMC electrical actuators.
2. This software can be installed and saved on a PC for the sole purpose specified in the preceding paragraph.

2. Restrictions

1. This software is not to be copied, except as specified in Article 1-2.
2. This software license is not to be transferred or lent wholly or in part to a third party, either free of charge or for payment.
3. Modification, translation, adaptation or reverse engineering of this software is not permitted.

3. Precautions

1. Read the "Safety Instructions", "Precautions", "Specific Product Precautions" and "Specifications" described in the manual for the equipment when using any equipment controlled by this software.
2. This Software and the equipment controlled by it are subject to change without prior notice.

4. Exemption of liability

1. SMC cannot take any responsibility for any damage incurred by the use of the controller to which the data is written by this Software.
2. SMC cannot take any responsibility for any damage incurred by the use of this software.

5. Termination

1. SMC has the full authority to terminate this agreement in the event of any terms and conditions have been breached.
2. This software and any copies thereof must be destroyed when this agreement is terminated.

6. Rights of this Software

The copyright and any other rights of this Software are owned by SMC, and protected by Japanese copyright laws and international treaty provisions.

2. Outline

The communication cable (LEC-W2A-C) is used to connect the electric actuator controller (LECP series, LECA series, JXC□1 series) and PC and helps communication between those devices using the controller setting software (ACT Controller).

Product specifications

Applicable controllers		LECP6, LECA6, LECPA, LECPMJ JXC□1 *1)
Applicable USB cables		LEC-W2-U *2)
Operating environment	OS	Windows®10, Windows®8.1, Windows®7
	Communication interface	USB1.1 or USB2.0 port

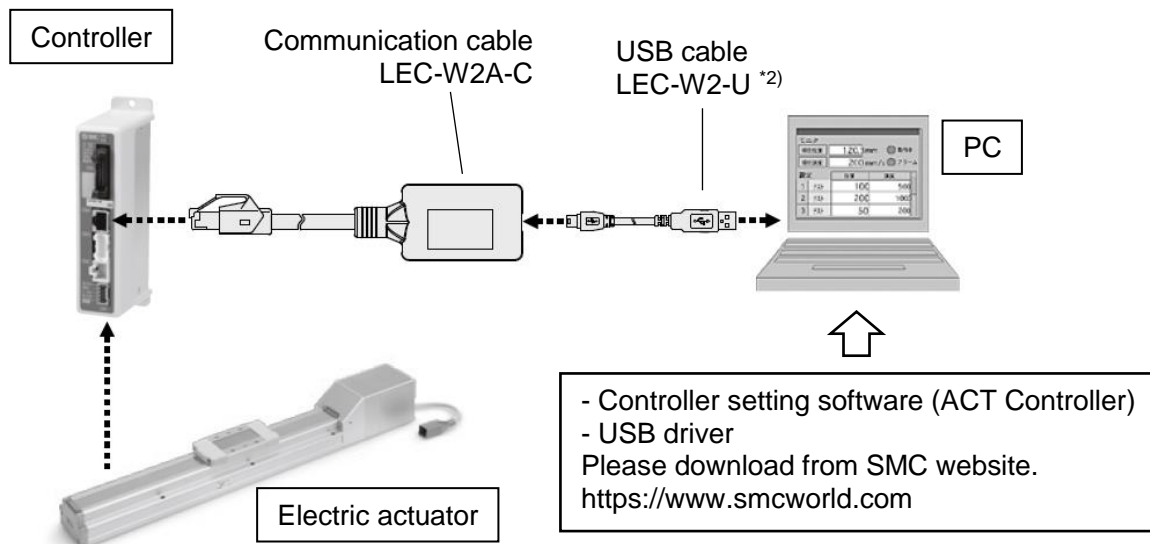

*1) Do not connect the cable to devices other than the applicable controllers.
When connecting the communication cable to the JXC□1 series, use a conversion cable.

Conversion cable No.: P5062-5

*2) Prepare a USB cable (A-miniB) LEC-W2-U to connect the communication cable and PC separately.

Caution

The communication setting cable (LEC-W2A-C) is a dedicated cable for the applicable controllers.

- The cable connected to the controllers is different from the LAN cable. Therefore, if the communication cable is connected to the LAN connector, the LAN connector might be broken.
- For the LECP and LECA series, connect the communication cable to the communication connector (CN4).
- For the JXC□1 series, connect the communication cable to the communication connector (SI) via a conversion cable (P5062-5). (It is not possible to directly connect the communication cable to the communication connector).

3. Installation of driver

3.1 Automatic Installation

Connect the communication cable LEC-W2A-C to the USB port of the PC in which Windows®10 has been installed via the USB cable (A-miniB), and start the PC device manager.

When the USB driver is already installed on the PC, “USB Serial Port (COM□)” is displayed under “Port (COM and LPT)”. (Numerical number is displayed in □)

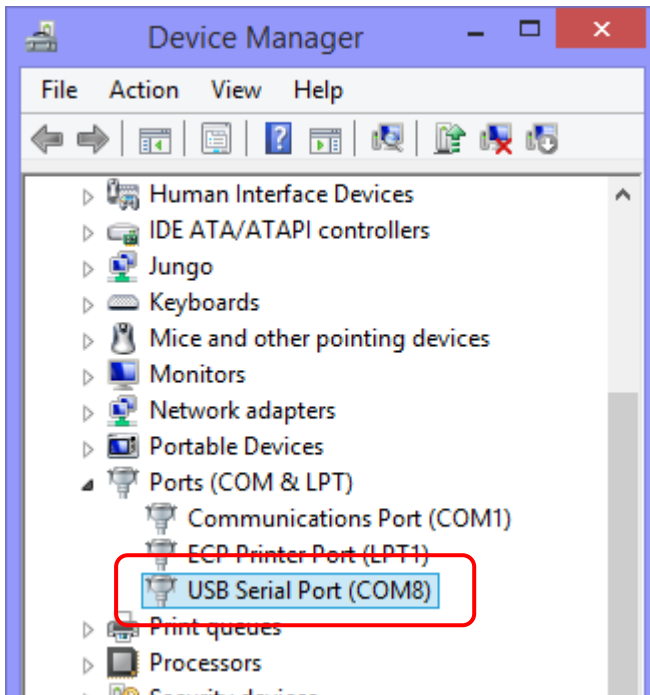

When “Port (COM & LPT)” is not displayed, “SMC Serial Converter” is displayed under “Other devices”. In this case, perform installation in accordance with “3.2 Manual Installation”.

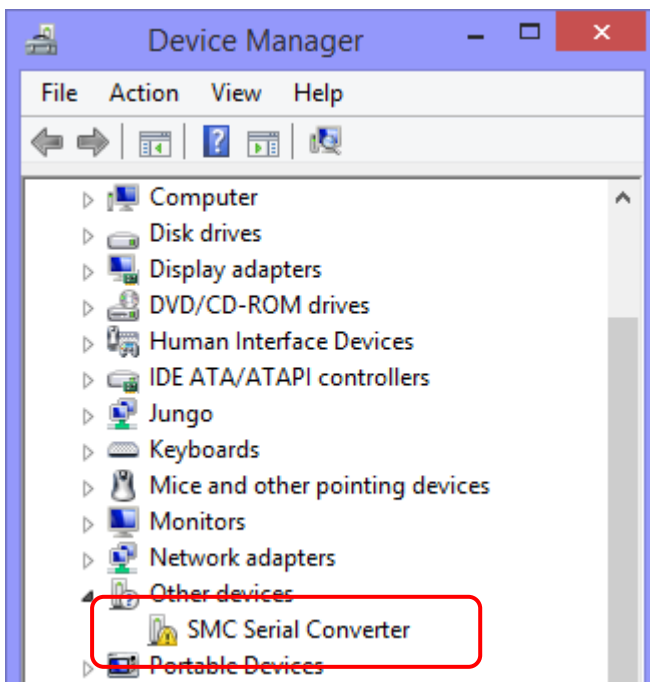

3.2 Manual Installation

~~Perform installation twice in the manual installation of the driver.~~ Follow the procedure as outlined below:

- (1) Please download the USB driver from the SMC website.
Create a folder on the PC and unzip the USB driver in the folder. When the driver is unzipped, the files below are displayed.

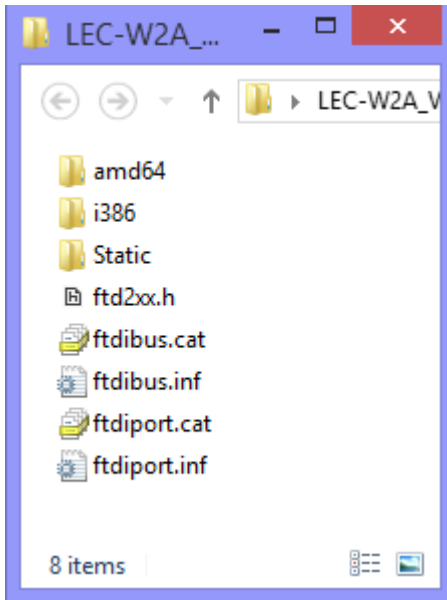

- (2) Start up the device manager and right click the “SMC Serial Converter” under “Other devices” to update the driver software.

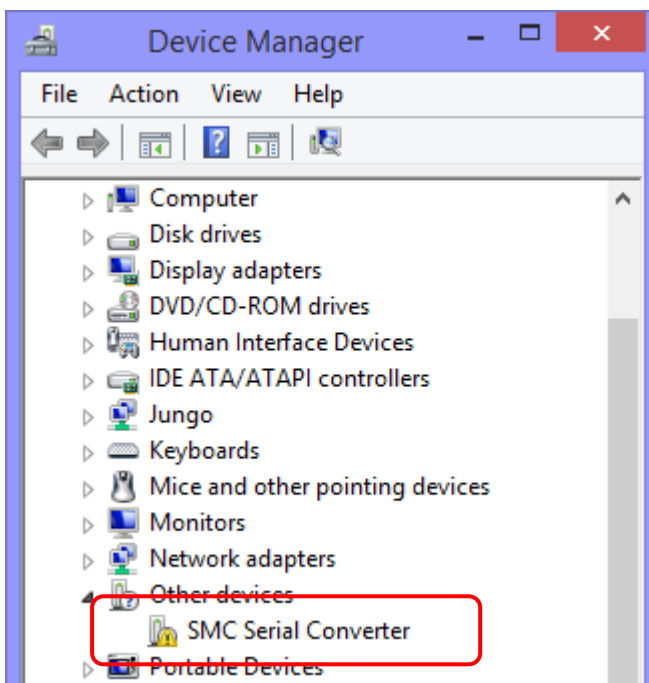

(3) When the following screen is displayed, select the “Browse my computer for driver software”.

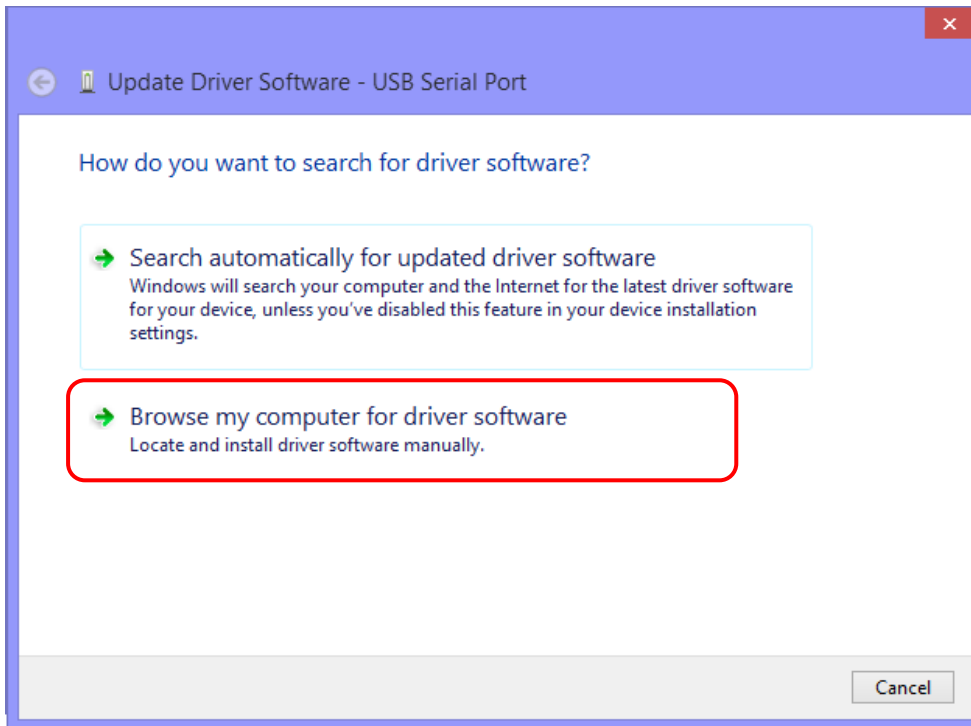

(4) Then the following screen is displayed, so select the folder in which the USB driver is unzipped as the reference page and click “Next”

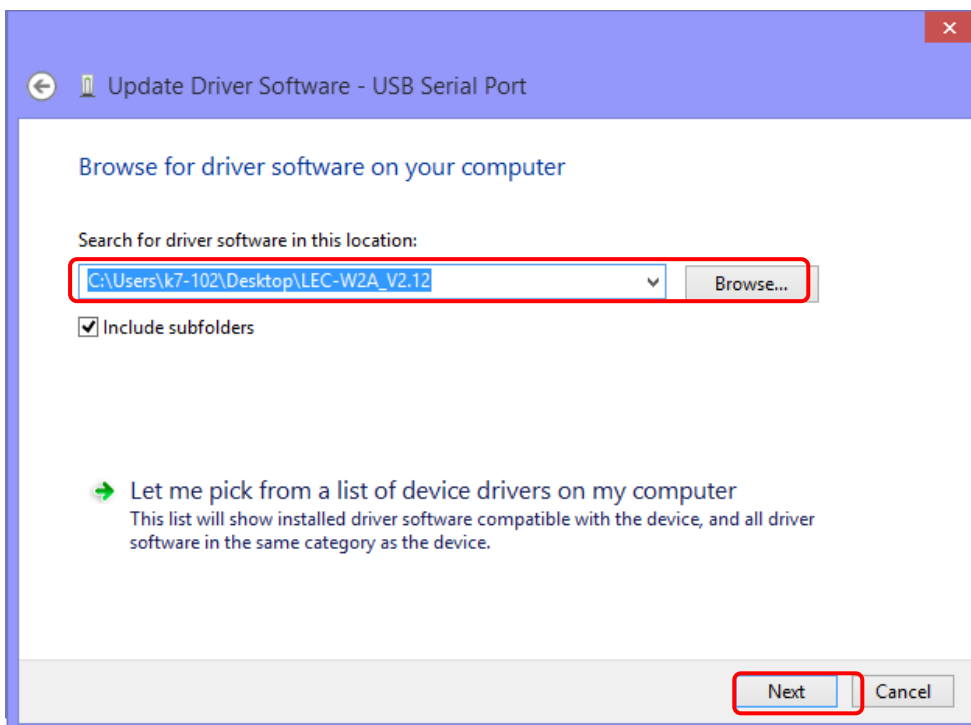

(5) When the driver is installed, “USB Serial Converter” is displayed under the Device Manager “Universal Serial Bus controllers”

Installation needs to be performed once again, so right click the “USB Serial Port” under the Other devices”, then select “Update Driver Software”.

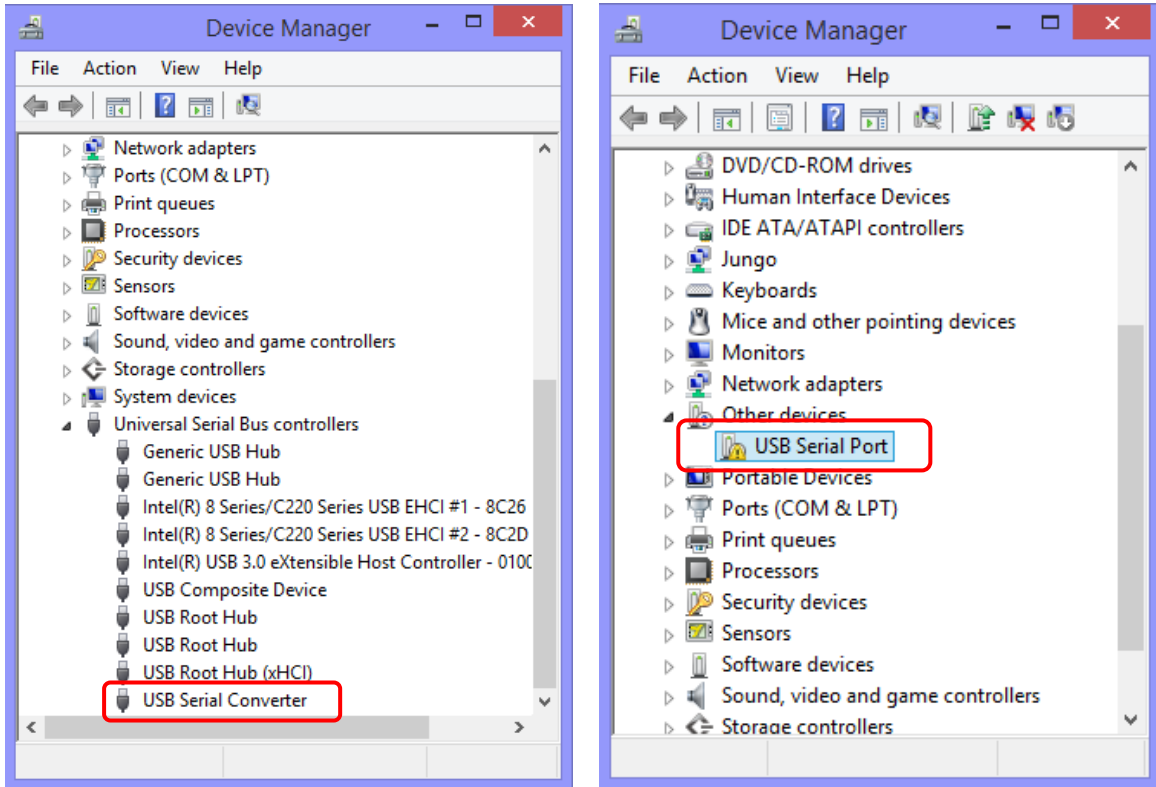

(6) Installation must be performed in accordance with (3) and (4).

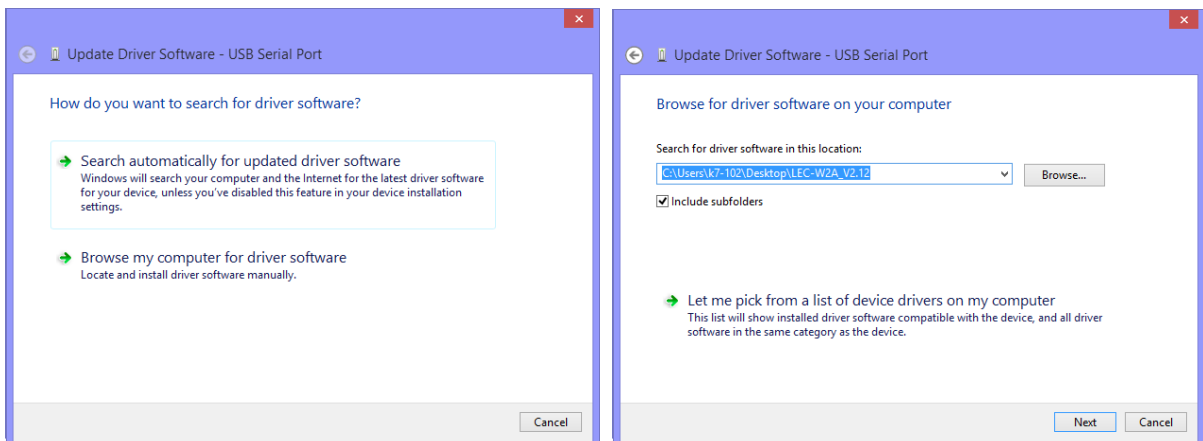

(7) Then, the driver is installed and “USB Serial Port (COM□)” is displayed under “Ports (COM & LPT).” Manual Driver installation has been completed.

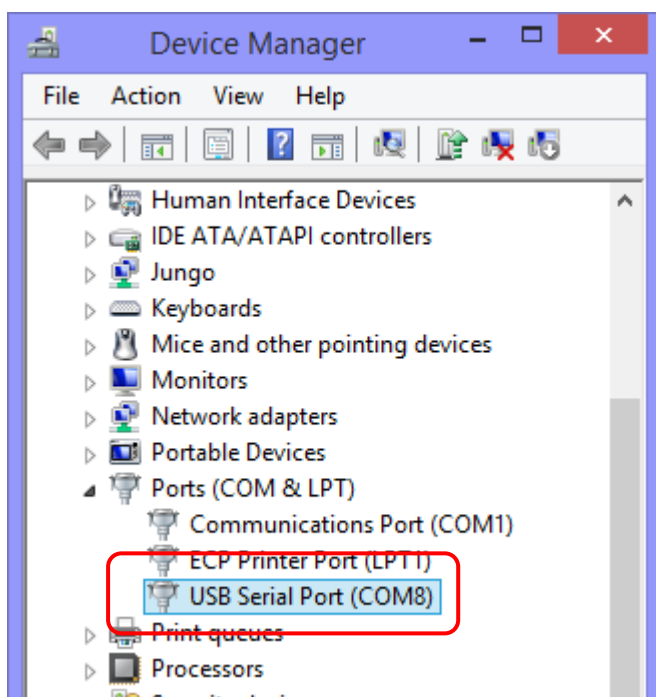

4. ACT Controller Installation

4.1 Installation

Install the controller setting software (ACT Controller), which has been downloaded from the SMC website. Create a folder on the PC and unzip the ACT Controller in the folder. Once the folder is unzipped, the ¥EN (Ver1200) folder is created, so execute the Setup.exe in the folder.

When the installation is complete, "ACT Controller Menu" is displayed on the desktop. Clicking this icon starts up the ACT Controller.

Read chapter "4.2. Check of the Communication Port" before starting the software.

4.2 Check of the Communication Port

Before using this setting software, it is necessary to check the communication port number (COM No.) which has been assigned to the communication unit. Check the COM No. using the Device Manager.

Connect the communication cable LEC-W2A-C to the USB port via the USB cable (A-miniB), and start the PC Device Manager .

Check the COM No., which is displayed in "USB Serial Port (COM□)" of the "Port (COM & LPT)".
(In the case of the figure below, the COM No. is "8".)

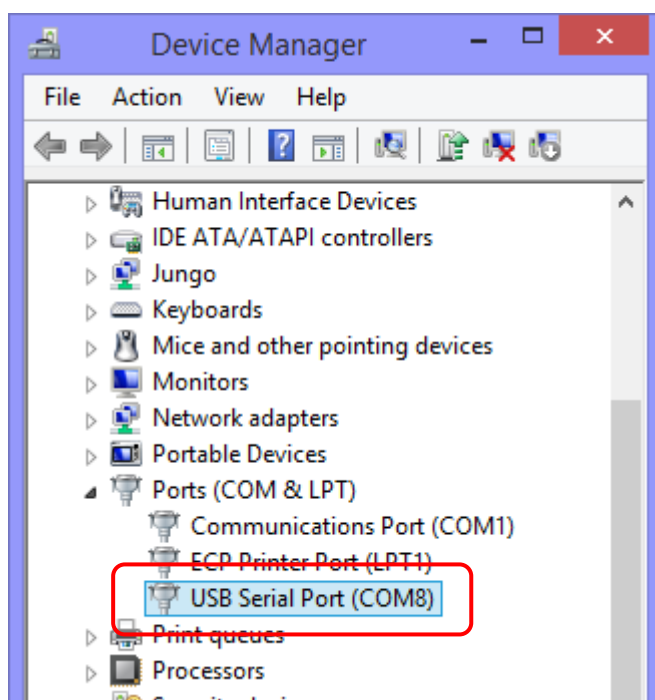

**The COM No. will change depending on the USB port where the communication cable is currently connected to.
Please check it after connecting the communication unit.**

4.3 Communication Setting

When activating the "Normal mode" or "Easy mode", the software recognizes the connected controller automatically. However, if the communication settings such as COM port number are incorrect, communication cannot be established, so communication set up is necessary.

An ACT Controller Menu icon is displayed on the desktop after installing the software. Double click the icon to display the menu shown below. Select "Normal Mode" or "Easy Mode".

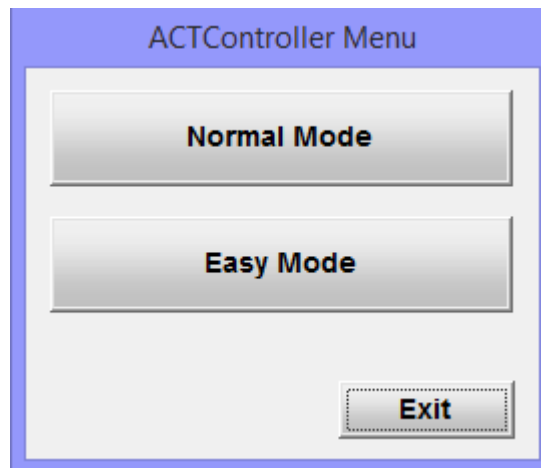

Confirm the following before starting communication.

- The controller for communication and PC are connected using the USB cable (A-miniB) LEC-W2-U and communication cable LEC-W2A-C.
(When connecting the communication cable to the JXC□1 series, use a conversion cable.)
- Check that power is supplied to the connected controller.

(1) Normal mode

By selecting the "Action" -> "System" -> "Setting" in the menu bar, the window shown below is displayed.

Set the COM port number confirmed in the step "4.2. Check of the Communication Port".

Maximum axis	Sets the number of axis
COM Port	Sets the COM port No. of the communication unit
Communication speed	Specifies the communication speed to the controller * The default communication speed of the controller (LEC / JXC) is 38400 bps.

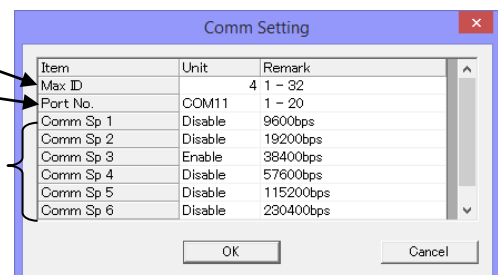

Selecting the "Action" -> "System" -> "Reset" after setting will initiate the software to recognize the connected controller.

The controller is not recognized if "Offline" is displayed in the red frame on the screen after starting the "Normal mode" as shown in the figure below.
 Check the communication port setting, wiring, and power supply to the controller and any other matter that may affect communication with the controller.

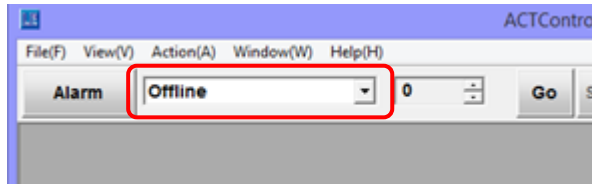

When the controller is recognized correctly, indication other than "Offline" (01-***, etc.) is displayed on the starting screen as shown in the figure below.

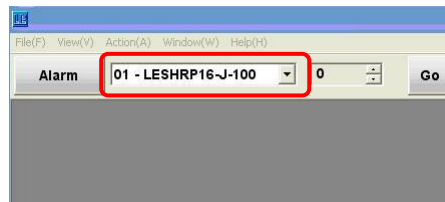

(2) Easy Mode

The communication setting screen is displayed if the communication cannot be established. The operation will be available when the connection is confirmed after the communication setting.

Maximum axis	Sets the number of axis	
COM Port	Sets the COM port No. of the communication unit	
Communication speed	Specifies the communication speed to the controller * The default communication speed of the controller (LEC / JXC) is 38400 bps.	

4.4 Functions of Each Mode

Refer to the "ACT Controller" -> "ACT Control Help" in the Program menu (Start button on Windows screen) for the function of each mode after installation.

Precautions

Do not turn off the controller for communication while the setting software (ACT Controller) is running.

Do not connect or disconnect the cable while the setting software is running.

The communication is continuously established while the setting software is running. Disconnecting the cable during communication may cause the software to become corrupt.

Revision history

Revision history	

SMC Corporation

4-14-1, Sotokanda, Chiyoda-ku, Tokyo 101-0021 JAPAN

Tel: + 81 3 5207 8249 Fax: +81 3 5298 5362

URL <https://www.smcworld.com>

Note: Specifications are subject to change without prior notice and any obligation on the part of the manufacturer.

Windows is the registered Trademark or the Trademark of Microsoft Corporation in the United States or other countries.

© 2019 SMC Corporation All Rights Reserved

