



# Operation Manual

Product Name

Electromagnetic Digital Flow Switch

Model/ Series/ Product Number

*LFE####*

## SMC Corporation

## Contents

Safety Instructions	2
Model Indication and How to Order	11
Summary of Product Parts	13
Definitions and Terminology	14
Mounting and Installation	16
Installation	18
Piping Method	19
Wiring	21
Flow Setting	24
Function Settings	26
Default Setting	26
F1 Setting of OUT1	28
F2 Setting of OUT2	36
F3 Response Time Setting	40
F10 Selection of display of sub screen	41
F20 External input	45
F22 Analogue Output Setting	46
F30 Accumulated Value Hold	47
F32 Flow direction setting	48
F33 Close proximity setting	50
F34 Zero-reset setting	51
F80 Setting of Power Saving Mode	52
F81 Setting of Security Code	53
F82 Input of Line Names	54
F90 Settings of All Functions	55
F98 Check of Output	56
F99 Reset to the Default Setting	57
Other Settings	58
Maintenance and Inspection	60
Troubleshooting	61
Specifications	64
Applicable Fluids	66
Characteristics Chart	67
Analogue Output	70
Dimensions	71



# Safety Instructions

These safety instructions are intended to prevent hazardous situations and/or equipment damage. These instructions indicate the level of potential hazard with the labels of "Caution," "Warning" or "Danger." They are all important notes for safety and must be followed in addition to International Standards (ISO/IEC)\*1), and other safety regulations.

\*1) ISO 4414: Pneumatic fluid power -- General rules relating to systems.  
ISO 4413: Hydraulic fluid power -- General rules relating to systems.  
IEC 60204-1: Safety of machinery -- Electrical equipment of machines .(Part 1: General requirements)  
ISO 10218: Manipulating industrial robots -Safety.  
etc.



## Caution

**Caution** indicates a hazard with a low level of risk which, if not avoided, could result in minor or moderate injury.



## Warning

**Warning** indicates a hazard with a medium level of risk which, if not avoided, could result in death or serious injury.



## Danger

**Danger** indicates a hazard with a high level of risk which, if not avoided, will result in death or serious injury.

## Warning

### 1. The compatibility of the product is the responsibility of the person who designs the equipment or decides its specifications.

Since the product specified here is used under various operating conditions, its compatibility with specific equipment must be decided by the person who designs the equipment or decides its specifications based on necessary analysis and test results.

The expected performance and safety assurance of the equipment will be the responsibility of the person who has determined its compatibility with the product.

This person should also continuously review all specifications of the product referring to its latest catalog information, with a view to giving due consideration to any possibility of equipment failure when configuring the equipment.

### 2. Only personnel with appropriate training should operate machinery and equipment.

The product specified here may become unsafe if handled incorrectly.

The assembly, operation and maintenance of machines or equipment including our products must be performed by an operator who is appropriately trained and experienced.

### 3. Do not service or attempt to remove product and machinery/equipment until safety is confirmed.

1. The inspection and maintenance of machinery/equipment should only be performed after measures to prevent falling or runaway of the driven objects have been confirmed.

2. When the product is to be removed, confirm that the safety measures as mentioned above are implemented and the power from any appropriate source is cut, and read and understand the specific product precautions of all relevant products carefully.

3. Before machinery/equipment is restarted, take measures to prevent unexpected operation and malfunction.

### 4. Contact SMC beforehand and take special consideration of safety measures if the product is to be used in any of the following conditions.

1. Conditions and environments outside of the given specifications, or use outdoors or in a place exposed to direct sunlight.

2. Installation on equipment in conjunction with atomic energy, railways, air navigation, space, shipping, vehicles, military, medical treatment, combustion and recreation, or equipment in contact with food and beverages, emergency stop circuits, clutch and brake circuits in press applications, safety equipment or other applications unsuitable for the standard specifications described in the product catalog.

3. An application which could have negative effects on people, property, or animals requiring special safety analysis.

4. Use in an interlock circuit, which requires the provision of double interlock for possible failure by using a mechanical protective function, and periodical checks to confirm proper operation.



# Safety Instructions

## Caution

### **1. The product is provided for use in manufacturing industries.**

The product herein described is basically provided for peaceful use in manufacturing industries. If considering using the product in other industries, consult SMC beforehand and exchange specifications or a contract if necessary.  
If anything is unclear, contact your nearest sales branch.

## **Limited Warranty and Disclaimer/ Compliance Requirements**

The product used is subject to the following “Limited warranty and Disclaimer” and “Compliance Requirements”.

Read and accept them before using the product.

### **Limited Warranty and Disclaimer**

#### **1. The warranty period of the product is 1 year in service or 1.5 years after the product is delivered, whichever is first.\*2)**

Also, the product may have specified durability, running distance or replacement parts. Please consult your nearest sales branch.

#### **2. For any failure or damage reported within the warranty period which is clearly our responsibility, a replacement product or necessary parts will be provided.**

This limited warranty applies only to our product independently, and not to any other damage incurred due to the failure of the product.

#### **3. Prior to using SMC products, please read and understand the warranty terms and disclaimers noted in the specified catalog for the particular products.**

##### **\*2) Vacuum pads are excluded from this 1 year warranty.**

A vacuum pad is a consumable part, so it is warranted for a year after it is delivered.

Also, even within the warranty period, the wear of a product due to the use of the vacuum pad or failure due to the deterioration of rubber material are not covered by the limited warranty.

### **Compliance Requirements**

#### **1. The use of SMC products with production equipment for the manufacture of weapons of mass destruction(WMD) or any other weapon is strictly prohibited.**

#### **2. The exports of SMC products or technology from one country to another are governed by the relevant security laws and regulation of the countries involved in the transaction. Prior to the shipment of a SMC product to another country, assure that all local rules governing that export are known and followed.**

## Caution

### **SMC products are not intended for use as instruments for legal metrology.**

Measurement instruments that SMC manufactures or sells have not been qualified by type approval tests relevant to the metrology (measurement) laws of each country.

Therefore, SMC products cannot be used for business or certification ordained by the metrology (measurement) laws of each country.

## ■ Explanation of Symbols

Symbol	Definition
	Things you must not do. Actual instructions are provided as a drawing or sentence close to this mark.
	Things you must do Actual instructions are provided as a drawing or sentence close to this mark.



## ■ Operator

<p>(1) This Operation Manual is intended for those who have knowledge of machinery using pneumatic equipment, and have sufficient knowledge of assembly, operation and maintenance of such equipment. Only those persons are allowed to perform assembly, operation and maintenance.</p> <p>(2) Read and understand this Operation Manual carefully before assembling, operating or providing maintenance to the product.</p>
---

## ■ Safety Instructions

Warning	
 Disassembly prohibited	Do not disassemble, modify (including the replacement of board) or repair. Otherwise, an injury or failure can result.
 Do not	Do not operate the product outside of the specifications. Do not use for flammable or harmful fluids. Fire, malfunction, or damage to the product can result. Please check the specifications before use.
 Do not	Do not use in an atmosphere containing flammable or explosive gases. Fire or an explosion can result. The product is not designed to be explosion proof.
 Do not	Do not use the product for flammable or highly permeable fluids. Fire, explosion, breakage or corrosion can result.
 Do not	Do not use the product in a place where static electricity is a problem. Otherwise failure or malfunction of the system can result.
 Instruction	If using the product in an interlocking circuit: - Provide a double interlocking system, for example a mechanical system. - Check the product for proper operation. Otherwise malfunction can result, causing an accident.
 Instruction	The following instructions must be followed during maintenance : - Turn off the power supply - Stop supplying fluid before maintenance. It may cause an injury.

## ⚠ Caution

 Do not touch	Do not touch the terminals and connectors while the power is on. Otherwise electric shock, malfunction or damage to the switch can result.
 Do not touch	Do not touch the piping joint or piping when hot fluid is used. It may lead to burn. Check that the piping is cooled down before touching it.
 Instruction	<ul style="list-style-type: none"> <li>■ After maintenance is complete, perform appropriate functional inspections and leak test.</li> <li>Stop operation if the equipment does not function properly or there is leakage of fluid.</li> <li>When leakage occurs from parts other than the piping, the product itself may be damaged.</li> <li>Cut off the power supply and stop the fluid supply.</li> <li>Do not apply fluid if the system is leaking.</li> <li>Safety cannot be assured in the case of unexpected malfunction.</li> </ul>

### ■ Handling Precautions

- Follow the instructions given below for selecting and handling.

- The instructions on design and selection (installation, wiring, environment, adjustment, operation, maintenance, etc.) described below must be followed.

\*Product specifications

- Use the specified voltage.

Otherwise failure or malfunction can result.

Insufficient supply voltage may not drive a load due to a voltage drop inside the product.

Check the operating voltage of the load before use.

- Do not exceed the specified maximum allowable load.

This may cause damage or shorten the lifetime of the product.

- Data stored by the product is not deleted, even if the power supply is cut off. (Write limit: 1000000 cycles, Data duration: 20 years after power off.)

- Confirm the pressure loss at the sensor according to the flow rate characteristics (pressure loss) graph before designing piping.

Confirm pressure loss of the sensor from the flow characteristics chart.

- Take care that pressure exceeding the specified range will not be applied due to water pulsation.

<Examples of measures for reducing water pulsation>

(1) Use a water pulsation resistant valve.

(2) Use elastic piping material such as rubber hose etc. and an accumulator to absorb impact pressure.

Shorten the length of piping as much as possible.

- Use the product within the specified operating pressure and temperature range.

Withstand pressure is 2.0MPa. Withstand pressure depends on fluid temperature. Refer to the chart of the operating pressure range.

- Reserve a space for maintenance.

When designing an application, allow sufficient clearance for maintenance and inspection.

- Product handling

- \* Mounting

- Tighten to the specified tightening torque.

- If the tightening torque is exceeded, the mounting screws and brackets may be damaged. Insufficient torque can cause displacement of the product from its proper position and the looseness of the mounting screws.

- (Refer to Mounting and Installation (page 16 to 23).)

- If a commercially available switching power supply is used, be sure to ground the frame ground (FG) terminal.

- Do not use where the product is subjected to vibration or impact.

- Otherwise damage to the internal components may result, causing malfunction.

- Do not pull the lead wire forcefully, or lift the product by the lead wire.

- (Tensile strength 49 N or less)

- Hold the product body when handling to prevent damage, failure or malfunction.

- The product will be damaged, leading to failure and malfunction.

- When multiple sensors are mounted together in parallel on an installation within the area not suitable for mounting next to the product, the display may flicker.

- Products should be mounted with a suitable distance between each sensor, or the close proximity setting mode should be set.

- For piping of the pressure switch, hold the piping with a wrench on the metal part of the product (piping attachment).

- Holding other parts of the product with a tool may damage the product.

- Specifically, make sure that the spanner does not damage the M12 connector.

- This will damage the connector.

- Any dust left in the piping should be flushed out by air before connecting the piping to the product.

- Otherwise it can cause damage or malfunction.

- Refer to the flow direction of the fluid indicated on the product label for installation and piping.

- Avoid piping in which the piping size of the IN side of the switch changes suddenly.

- If the piping size is reduced suddenly, or there is a restrictor such as a valve on the IN side, the fluid velocity distribution in the piping will be disturbed, leading to improper measurement. Therefore, the above mentioned piping reduction or restrictor should be connected on the OUT side.

- If the OUT side is opened, or the flow rate is excessive, cavitations may be generated, which may result in improper measurement. As a measure against this, it is possible to reduce the cavitations by increasing the fluid pressure.

- Take action such as mounting an orifice on the OUT side of the switch, and confirm that there is no malfunction before handling.

- If the orifice of the OUT side is fully closed to operate the pump, the switch may malfunction due to the effect of pulsation (pressure fluctuation). Ensure that there is no malfunction before use.

- Do not insert metal wires or other foreign matter into the flow path.

- This can damage the sensor causing failure or malfunction.

- Never mount the product in a place that will be used as a scaffold during piping.

- The product may be damaged if excessive force is applied by stepping or climbing onto it.

## **- Design and install the product so that fluid always fills the detection passage.**

1, If the detection passage is not filled or the product is used in the condition where air bubbles are easily generated, the electrode cannot receive a correct detection signal, which may lead to incorrect measurement.

For vertical mounting, apply fluid from the bottom to the top. Bubbles may be generated when applying fluid from the top to the bottom, leading to operation failure.

(There should not be a problem as long as the fluid passage is completely filled with fluid)

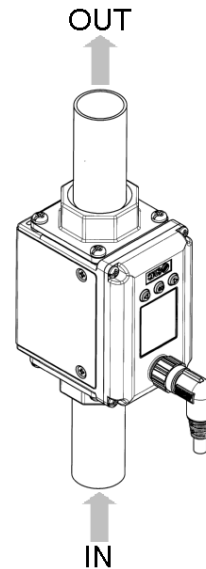

2. When the product is mounted vertically, place the display perpendicular to the floor (to place the electrodes on the right and the left) to prevent bubbles from occurring.

After installation, the flow direction can be changed by setting. Refer to "Operation" in page 48 for details for setting.

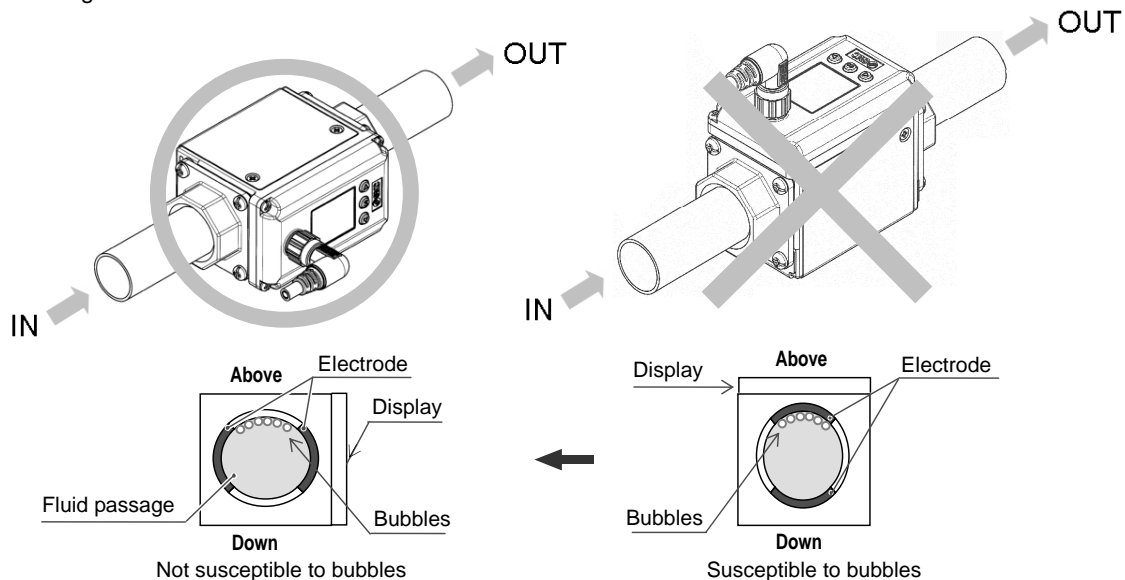



- \* Wiring (Including connecting/disconnecting of the connectors)
  - Do not pull hard on the lead wire, or lift the product by holding the lead wires (Tensile strength 49 N or less). Especially never lift the product equipped with fitting and piping by holding the lead wires.  
Damage to the connector, circuit board, cover or internal components may result, causing failure or malfunction.
  - Avoid repeatedly bending, stretching or applying a heavy object or force to the lead wire.  
Repetitive bending stress or tensile stress can cause the sheath of the wire to peel off, or breakage of the wire.  
If the lead wire can move, fix it near the body of the product.  
The recommended bend radius of the lead wire is 6 times the outside diameter of the sheath, or 33 times the outside diameter of the insulation material, whichever is larger.  
Replace the damaged lead wire with a new one.
  - Wire correctly.  
Incorrect wiring can cause malfunction or damage the product.
  - Do not perform wiring while the power is on.  
Otherwise damage to the internal components may result, causing malfunction.
  - Do not route wires and cables together with power or high voltage cables.  
Route the wires of the product separately from power or high voltage cables to prevent noise and surge from entering the product.
  - Confirm proper insulation of wiring.  
Poor insulation (interference with other circuits, poor insulation between terminals etc.) can apply excessive voltage or current to the product causing damage.
  - Design the system to prevent reverse current when the product is performing an operational check.  
Depending on the circuit used, insulation may not be maintained when operation is forced, allowing reverse current to flow, which can cause malfunction and damage to the product.
  - Keep wiring as short as possible to prevent interference from electromagnetic noise and surge voltage.  
Do not use a cable longer than 10 m.  
Wire the DC (-) line (blue) as close as possible to the power supply.
  - When analogue output is used, install a noise filter (line noise filter, ferrite element, etc.) between the switch-mode power supply and the product.

## Operating environment

- Do not use the product in an environment where the product is constantly exposed to water splashes.  
Otherwise failure or malfunction can result. Take measures such as using a cover.
  - Do not use in an environment where the product could be exposed to corrosive gas or liquids.  
Otherwise damage to the internal parts can result, causing malfunction.
  - Do not use the product in a place where the product could be splashed by oil or chemicals.  
If the product is to be used in an environment containing oils or chemicals such as coolant or cleaning solvent, even for a short time, it may be adversely affected (damage, malfunction, or hardening of the lead wires).
  - Do not use the product with a corrosive fluid or a fluid with an electric conductivity of less than 5 $\mu$ S/cm.  
Do not use the product with a fluid which may corrode the fluid contact part or a fluid with a low electric conductivity, such as pure water or oil.
  - Make sure that foreign matter is not allowed in the detection passage.  
If a large amount of insulating substances are adhered to the passage, incorrect detection may occur.  
If electrically conductive substances are adhered to the internal surface of the detection passage, it may lead to incorrect detection.
  - Do not use in an area where surges are generated.  
When there are machines or equipment that generate large surges near the product (magnetic type lifter, high frequency inductive furnace, motor, etc.), this can result in deterioration and damage of the internal elements. Take measures against the surge sources, and prevent the lines from coming into close contact.
  - Do not use a load which generates surge voltage.  
When a surge-generating load such as a relay or solenoid is directly driven, use the product with a surge absorbing element built-in.
  - The product is CE marked, but not immune to lightning strikes. Take measures against lightning strikes in the system.
  - Mount the product in a location that is not affected by vibration or impact.  
Failure or malfunction may result.
  - Do not use the product in the presence of a magnetic field.  
Malfunction can result.
  - Do not let foreign matter, such as wire debris, get inside the product.
    - In order to avoid failure and malfunction, do not let foreign matter, such as wire debris, get inside the product.
- Do not use the product in an environment that is exposed to temperature cycle.  
Heat cycles other than ordinary changes in temperature can adversely affect the internal components of the product.
- Do not expose the product to direct sunlight.  
If using in a location directly exposed to sunlight, protect the product from the sunlight.  
Failure or malfunction may result.
  - Keep within the specified operating fluid and ambient temperature range.  
The operating fluid temperature range is 0 to 85 °C, and ambient temperature range is 0 to 50°C.  
If the fluid freezes, it may cause damage and malfunction of the switch, so please take measures to prevent freezing.  
If the temperature of the fluid is lower than the ambient temperature, condensation will be generated which may damage the product or cause malfunction.  
Protection against freezing is necessary.  
Avoid abrupt temperature changes even within the specified temperature range.  
Failure or malfunction may result.
  - Do not operate close to a heat source, or in a location exposed to radiant heat.  
Insufficient air quality may cause operation failure.

#### \* Adjustment and Operation

- Connect a load before turning the power supply on.  
If the power supply is turned on with no load, over current may flow, causing the product to break instantly.
- Do not short-circuit the load.  
Although error is displayed when the product load has a short circuit, generated over current may lead to the damage of the product.
- Do not press the setting buttons with a sharp pointed object.  
This may damage the setting buttons.
- Supply the power when there is no flow.
- There will be a drift on the display / analogue output of approx 2 to 3% for 5 minutes after the power supply is turned on.
- The product doesn't produce and output signal for 3 seconds after the power is supplied.
- Perform settings suitable for the operating conditions.  
Incorrect setting can cause operation failure.  
For details of each setting, refer to page 24 to 59 of this Operation Manual.
- During the initial setting and flow setting, the product will switch the measurement output with the condition before setting.  
Check the effect to the equipment before setting.  
Stop the control system for setting, if necessary.
- Do not touch the LCD during operation.  
The display can vary due to static electricity.
- Make sure that a zero-reset is performed when the detection passage is filled.  
Otherwise, detection may not be performed correctly.
- Immediately after switching to the close proximity setting, the display/analogue output may fluctuate.  
Be sure to check for the influence on the product.  
The control system should be turned off before setting.

#### \* Maintenance

- Confirm safety by turning off the power supply and stopping the flow before performing maintenance.  
There is a risk of unexpected malfunction.
- Perform regular maintenance and inspections.  
There is a risk of unexpected failure of components due to the malfunction of equipment and machinery.
- Do not use solvents such as benzene, thinner etc. to clean the product.  
This may damage the surface of the body or erase the markings on the body.  
Use a soft cloth to remove stains.  
For heavy stains, use a cloth soaked with diluted neutral detergent and fully squeezed, then wipe up the stains again with a dry cloth.

## Model Indication and How to Order

LFE□□□□□

Body size (Flow rate range)

Symbol	Content
1	0.5~ 20L/min
2	2.5~100L/min
3	5~200L/min

Output Specifications

Symbol	OUT1	OUT2
A	NPN	NPN
B	PNP	PNP
C	NPN	Analogue 1 to 5V
D	NPN	Analogue 4 to 20mA

Port size

Symbol	Port size	Rated flow range		
		1	2	3
3	3/8	Yes	-	-
4	1/2	Yes	-	-
6	3/4	-	Yes	-
8	1	-	-	Yes

Options

Symbol	Lead wire	Bracket	Display Unit
Nil	Yes	-	L/min
1	-	-	L/min
2	Yes	Yes	L/min
3	-	Yes	L/min
4	Yes	-	gal/min
5	-	-	gal/min
6	Yes	Yes	gal/min
7	-	Yes	gal/min

Thread type

Symbol	Content
Nil	Rc
N	NPT
F	G

### Lead wire

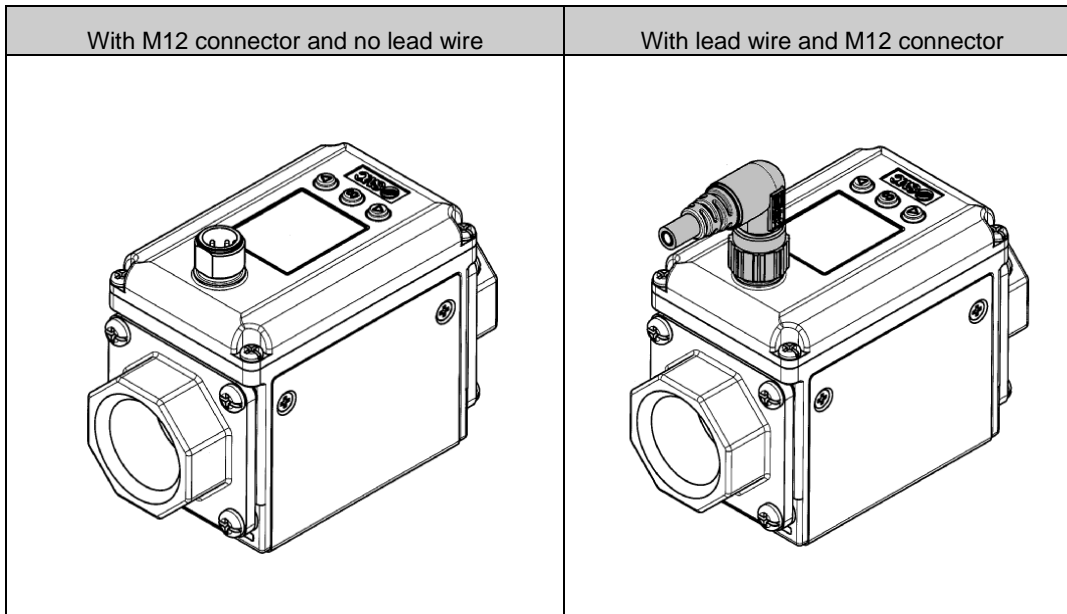

### Bracket

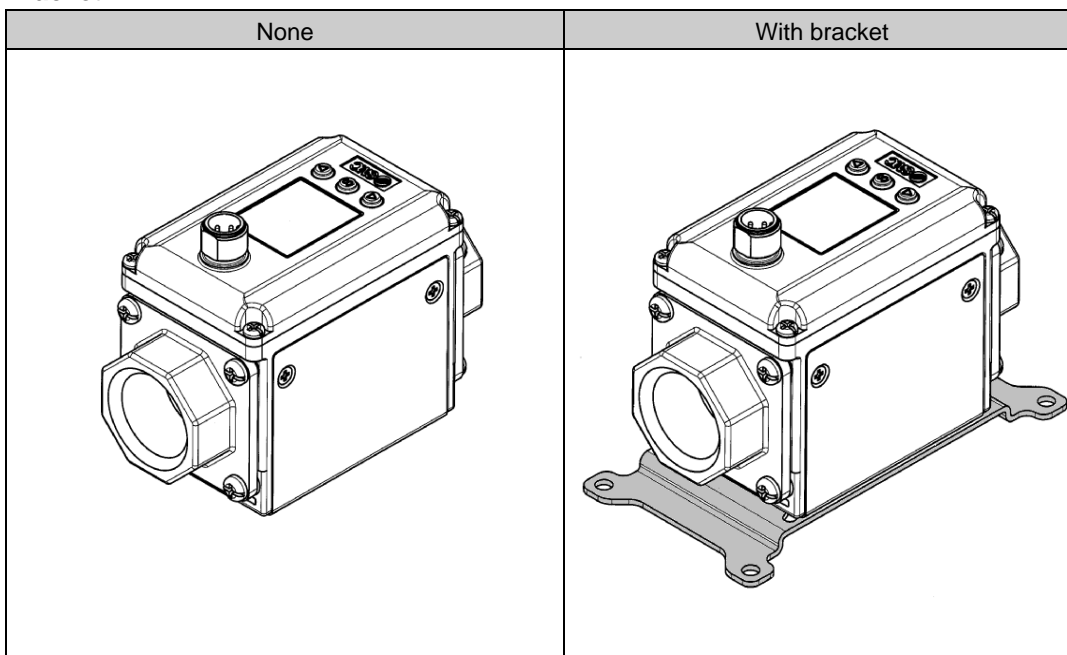

### Accessories/ Part numbers

If an accessory is required, order using the following part number.

Option	Product No.	Remarks	Weight
With lead wire and M12 connector	LFE-1-A3	Lead wire length: 3 m	Approx. 175 g
Bracket	LFE-1-D	Tapping screw 3 x 10, 4 pcs.	Approx. 45 g
	LFE-2-D	Tapping screw 3 x 10, 4 pcs.	Approx. 70 g
	LFE-3-D	Tapping screw 3 x 10, 4 pcs.	Approx. 70 g

## Summary of Product Parts

### Body

With lead wire and M12 connector (4 pins)

(Option)

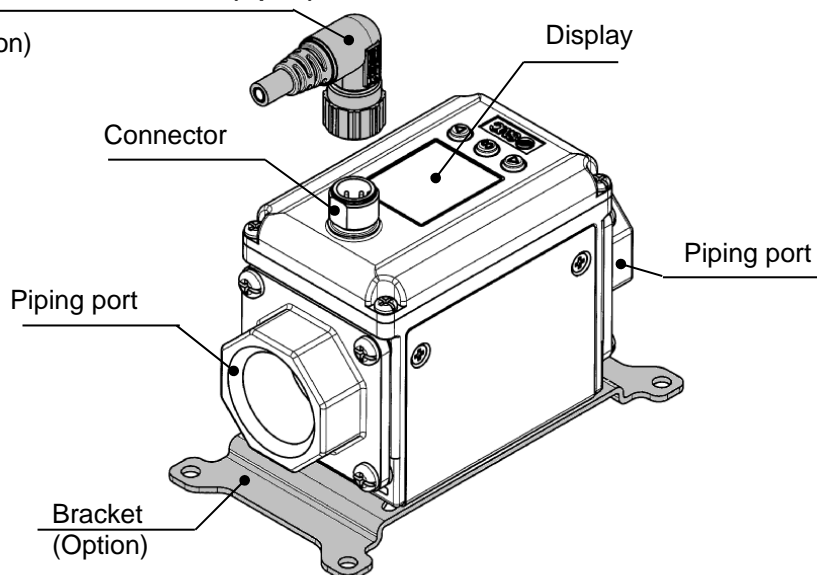

Description	Function
Connector	The part to which lead wires are connected.
With lead wire and M12 connector	This is a cable that supplies power to the product and receives output.
Piping port	For piping connections.
Bracket	This is a mounting bracket used to install the product.
Displays	Displays the flow, setting values and error information. See below

### Display

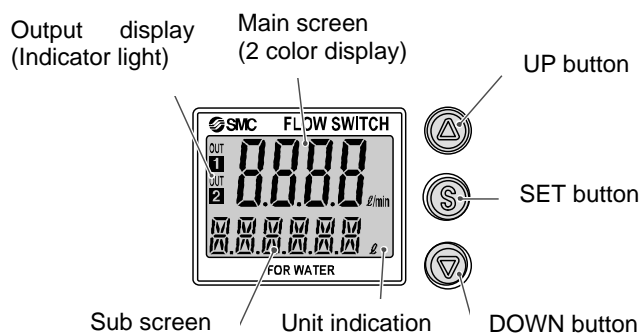

Description	Function
Main screen (2 color display)	Displays the flow value, setting mode and error codes.
Sub screen	Displays the accumulated flow, set value, peak/bottom value, and line names, flow direction and close proximity setting mode. In the measurement mode, the set status is displayed.
Output display (Indicator light)	Displays the output status of OUT1 and OUT2. LED is ON (Orange) when OUT1 is ON.
UP button	Selects the mode and the display shown on the Sub display, or increases the ON/OFF set value.
SET button	Press this button to change the mode and to set a value.
DOWN button	Selects the mode and the display shown on the Sub display, or decreases the ON/OFF set value.
Units indication	Indicates the unit currently selected.

■ Definition and terminology

	Term	Meaning
A	Accumulated flow external reset	A function to reset the accumulated flow to zero by using an external signal
	Accumulated flow	The total amount of fluid that has passed through the device. If an instantaneous flow of 10 L/min lasts for 5 minutes, the accumulated flow will be $10 \times 5=50$ L.
	Accumulated pulse output	A type of output where a pulse is generated every time a predefined accumulated flow passes. It is possible to calculate the total accumulated flow by counting the pulses.
	Accumulated-value hold time.	A function to store the cumulative flow value in the product's internal memory at certain time intervals. Reads the memory data when power is supplied. Accumulation of data begins with the value read at the moment power is supplied. The time interval for memory data storage is selectable from 2 or 5 minutes.
	Ambient temperature range	Ambient temperature range in which the product can operate.
	Analogue output	Outputs a value proportional to the flow rate. When the analogue output is in the range 1 to 5V, it will vary between 1 to 5V according to the rate of flow. The same for analogue output of 4 to -20 mA.
	Attachment	The metal part of both sides of the product to which piping is connected.
C	Cavitation	A phenomenon that may occur in a fluid moving at high speed. In the parts of the fluid where the pressure is low, vapor bubbles form and then rapidly collapse. If cavitation is present for a prolonged period, exposed surfaces will be damaged; this is called cavitation damage or, erosion.
	Chattering	The problem of the switch output turning ON and OFF repeatedly around the set value at high frequency due to the effect of pulsation.
D	Display range	The range of measured values that can be displayed for a product with a digital display.
E	Electric conductivity	The electric conductivity is a ratio which shows how easily the electricity flows. The unit is [S/cm] (siemens/centimeter). The lower the electric conductivity, the more difficult the electricity flows in the fluid. On the contrary, the higher the electric conductivity, the easier the electricity flows in the fluid. The minimum electrical conductivity for fluids for this sensor is 5uS/cm. Conductivity of tap water is 100 to 200uS/cm.
F	F.S.(full span/full scale)	This means "full span" or "full scale", and indicates varied analogue output range at rated value. For example, when analogue output is 1 to 5 V, F.S.=5[V] – 1[V]=4[V]. (Reference: 1%F.S. = 4[V] × 1% = 0.04[V])
	Fluid contact part	A part that comes into physical contact with the fluid.
	Fluids	The fluid(s) that the product can measure.
H	Hysteresis	The difference between ON and OFF points used to prevent chattering. Hysteresis can be effective in avoiding the effects of pulsation.
	Hysteresis mode	Mode where the switch output will turn ON when the flow is greater than the set value, and will turn OFF when the flow falls below the set value by the amount of hysteresis or more.
I	Instantaneous flow	The flow passing per unit of time. If it is 10 L/min, there is a flow of 10 L passing through the device in 1 minute.
	Internal voltage drop	The voltage drop across the product (and therefore not applied to the load), when the switch output is ON. The voltage drop will vary with load current, and ideally should be 0 V.
K	Key-lock function	Function that prevents changes to the settings of the product (disables button operation).
M	Min. setting unit	The resolution of set and display values. If the minimum setting unit is 1 L/min, the display will change in 1 L/min steps, e.g. 10.....11.....12 L/min.

	Term	Meaning
O	Operating fluid temperature	Range of fluid temperature that can be measured by the product.
	Operating pressure range	The pressure range in which the product can be used.
P	Power saving mode	Number display is turned off to reduce power consumption.
	Pressure characteristics	Indicates the change in the display value and analogue output when fluid pressure changes.
R	Rated flow range	The flow range within which the product will meet all published specifications.
	Rated pressure range	The pressure range that satisfies the specifications.
	Repeatability	Reproducibility of the display or analogue output value, when the measured quantity is repeatedly increased and decreased.
	Response time	Time from when the target flow is applied until the flow reaches 63% of the set value.
S	Set point range	The range of ON/OFF threshold values that can be set for those products with a switch output.
	Switch output	Output type that has only 2 conditions, ON or OFF. In the ON condition an indicator LED will show, and any connected load will be powered. In the OFF condition, there will be no indicator LED and no power supplied to the load. An output showing such behavior is called switch output.
T	Temperature characteristics	Indicates the change in the display value and analogue output caused by ambient temperature or fluid temperature changes.
U	Unit selection function	A function to select display units other than the international unit (SI unit) specified in the new Japanese measurement law. The product is not equipped with this function. LFE series does not have unit selection function.
W	Water hammer	Water hammer or impact pressure is a pressure surge due to pressure spread when a fluid in motion is forced to stop or change direction when equipment such as valve, is opened/closed.
	Withstand pressure	Burst pressure at which the product is electrically or mechanically damaged.
	Window comparator mode	An operating mode in which the switch output is turned on and off depending on whether the flow is inside or outside the range of two set values
Z	Zero-reset	A function to adjust the flow rate display to zero.



## Mounting and Installation

### Installation

- Use the product within the specified operating pressure and temperature range.
- Withstand pressure is 2.0MPa.  
Withstand pressure depends on fluid temperature. Refer to the chart of the operating pressure range. (page 69)

### Mounting

- Never mount the switch in a place that will be used as a scaffold.
  - Mount the product so that the fluid flows in the direction indicated by the arrow on the side of the body.
  - Check the flow characteristics data for pressure loss and the straight inlet pipe length effect on accuracy (page 68), to determine inlet piping requirements.
  - Do not suddenly reduce the piping diameter.
  - Piping port and the metal part of the body are grounded to DC(-)/blue line.  
Do not use the power supply with positive ground.
- When multiple sensors are used in parallel, install them outside of the area shown below. (area not suitable for installation).  
If multiple sensors are mounted too close together, the display may flicker.

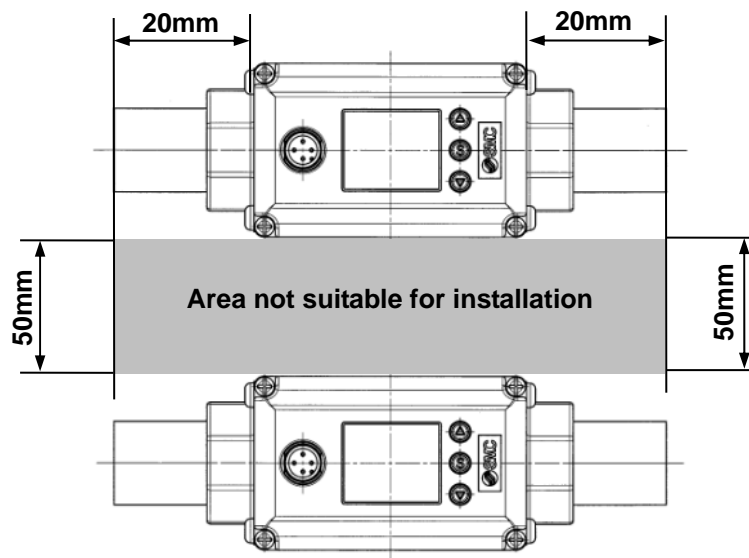

When products must be mounted within the area not suitable for mounting, it is possible to prevent the display from flickering using the close proximity setting function.

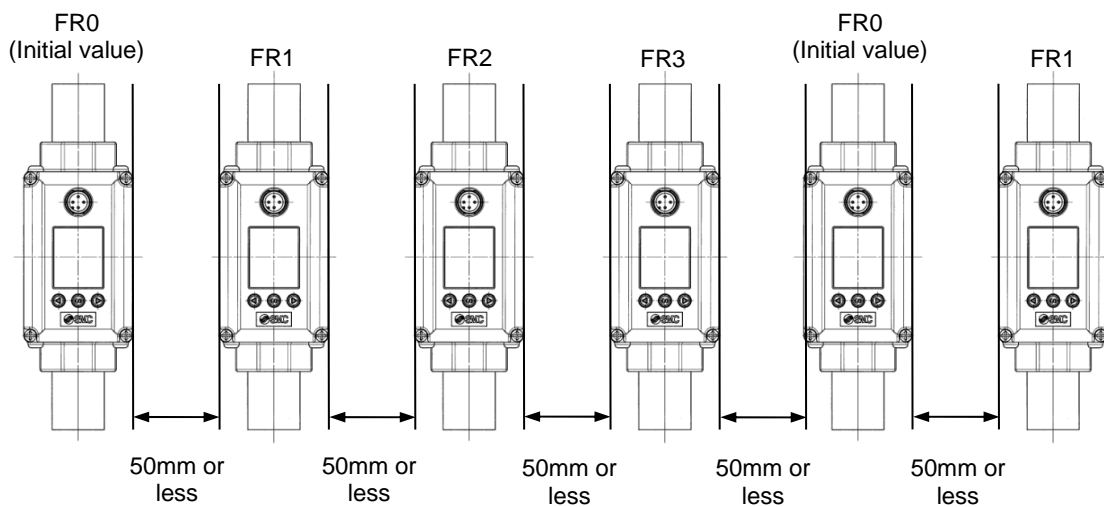

## ■ Installation

### Bracket mounting

Fix the bracket using the mounting screws (Equivalent to M4: 4 pcs.).

Bracket thickness is approx. 1.6mm

Refer to the outline dimension drawing (page 71) for mounting hole sizes.

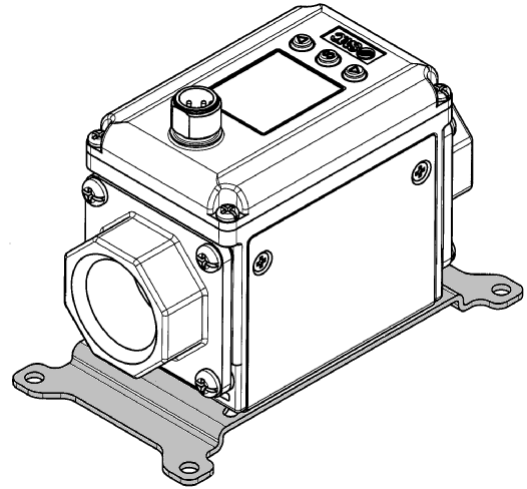

### Direct mounting

Mount the product with the screw stated below.

Thread type	Nominal thread size	Tightening torque
Tapping screw	3	0.7 to 0.8 Nm

Refer to the outer dimensional drawing (page 71) for the diameter and depth of the mounting screw holes.

- If you are installing directly, choose the self tapping screw screw-in depth is to 8mm.
- The self tapping screws cannot be reused.

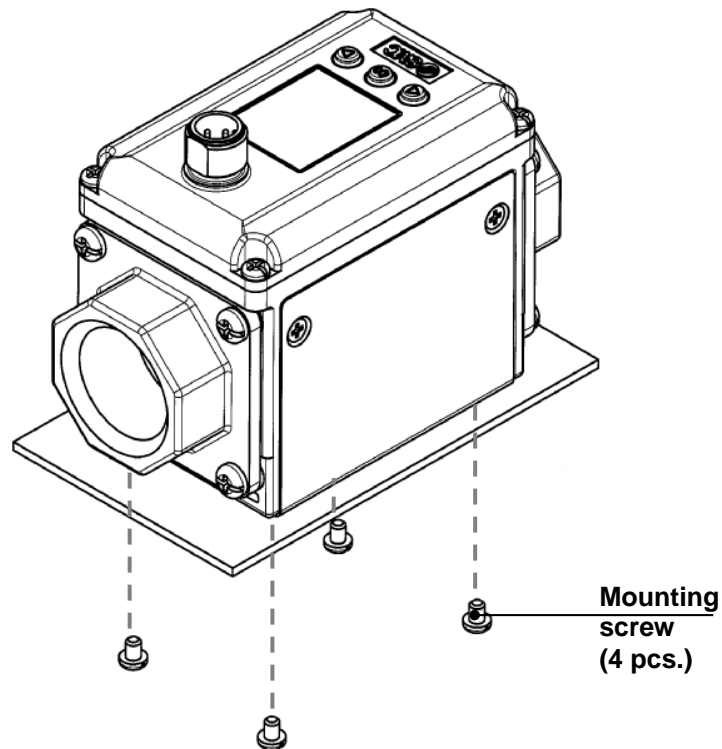

■ Piping method

When connecting the piping to the product, do not rotate the switch. Apply a spanner to the metal part of the piping port to turn the fitting.”

Using a spanner on other parts may damage the product.

Specifically, make sure that the spanner does not damage the M12 connector.

This will damage the connector.

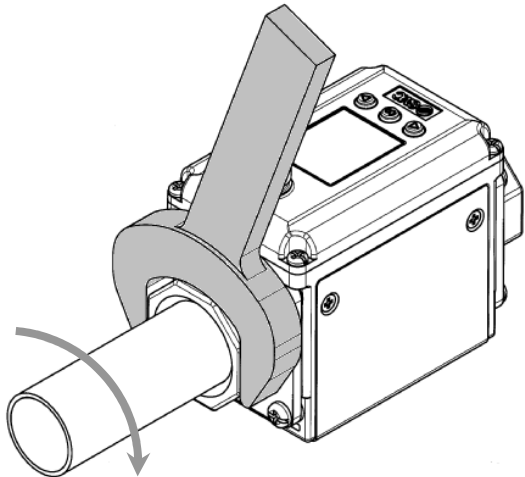

Width across flats of attachment

3/8	24 mm
1/2	28 mm
3/4	35 mm
1	41 mm

- Ensure that the piping is tightened to the required torque.

The tightening torque for connection threads is shown in the table below.

Nominal thread size	Appropriate tightening torque
Rc(NPT)3/8	22 to 24 Nm
Rc(NPT)1/2	28 to 30 Nm
Rc(NPT)3/4	28 to 30 Nm
Rc(NPT)1	36 to 38 Nm

If the tightening torque is exceeded, the product can be damaged. If the tightening torque is insufficient, the mounting screws and brackets may become loose.

The product body is made of resin. Do not apply direct stress, vibration or impact during piping to avoid malfunction, damage or water leakage. Never mount the product in a location that will be used as a scaffold.

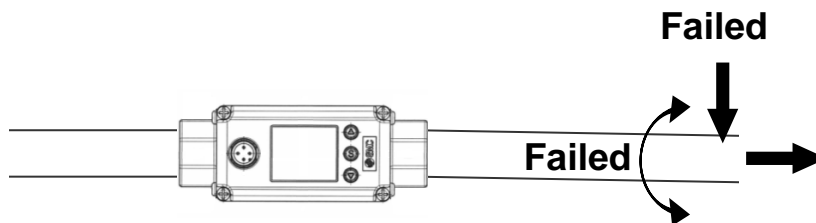

- Affix the piping as close to the product as possible (both before and after the product) to avoid direct stress, vibration or impact.

If the stress, vibration or impact cannot be reduced, affix the product at multiple locations.

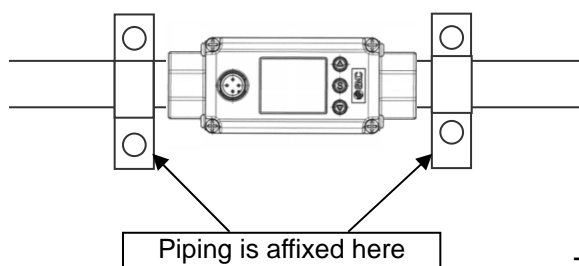

Non-flexible piping materials such as steel piping will be subject to excessive moment load, vibration and impact from the piping side, so use a flexible tube for intermediate connection. Misaligned piping may apply long-term load after piping, causing malfunction, damage, or water leakage.

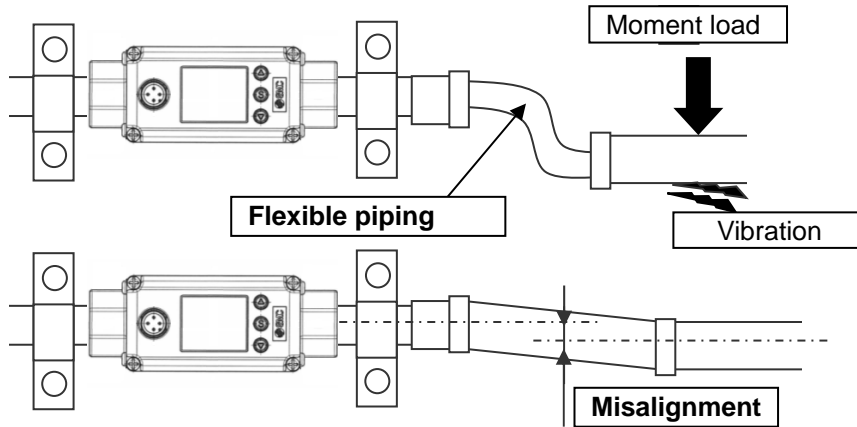

If one-touch fitting is used, hold the fitting by hand so that the load for mounting and removing the tube will not be applied to the product.

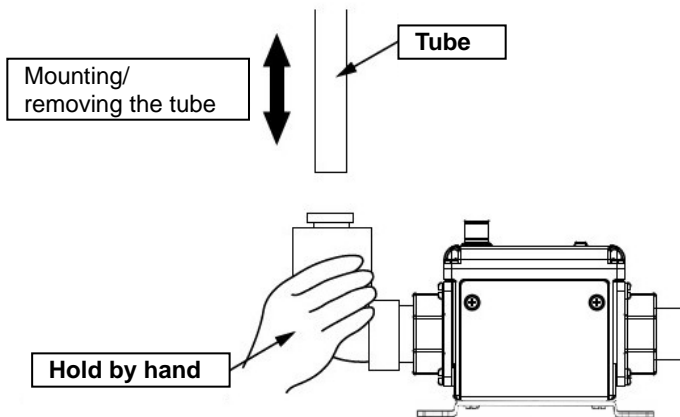

The IN side straight piping length shall be a minimum of 5 times (5D) the piping size to achieve a stable measurement. (page 68)

Avoid any sealing tape getting inside the piping.  
 - Ensure that there is no leakage from loose piping.

■ Wiring

**Connector**

Attaching/detaching of the connector should be done while the power supply is turned off.

Use a separate route for the product wiring and any power or high voltage wiring.

Otherwise, malfunction may result due to noise.

Ensure that the FG terminal is connected to ground when using a commercially available switch-mode power supply.

If the switch-mode power supply is connected for use, switching noise will be superimposed and it will not be able to meet the product specifications.

This can be prevented by inserting a noise filter such as a line noise filter and a ferrite element between the switch-mode power supply and the pressure switch, or by using a linear power supply instead of a switch-mode power supply.

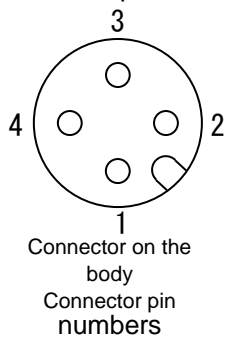

1	DC polar indication
2	OUT2
3	DC (-)
4	OUT1

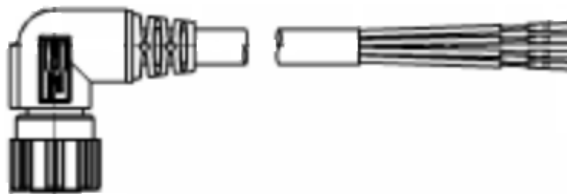
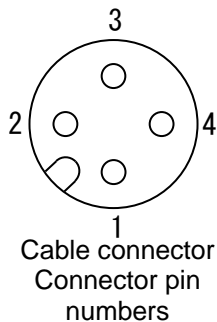

1	DC (+): Brown
2	OUT2: White
3	DC (-): Blue
4	OUT1: Black

\*: When using the lead wire with M12 connector included with the LFE series.

### Internal Circuit and Wiring examples

NPN 2 output type

LFE□A□□□

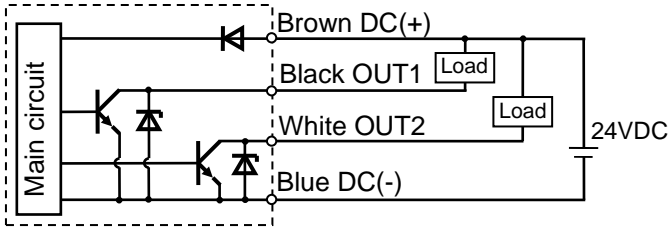

Max.28 V, 80 mA  
Internal voltage drop 1 V max.

PNP 2 output type

LFE□B□□□

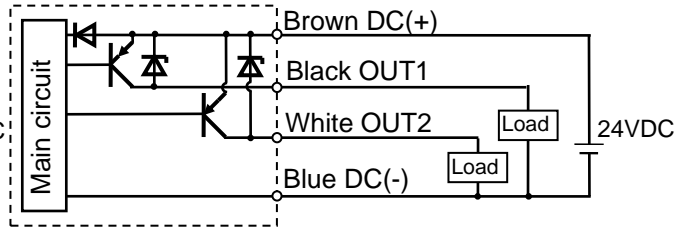

Max.80 mA  
Internal voltage drop 1.5 V max.

NPN + Analogue output type

LFE□C□□□

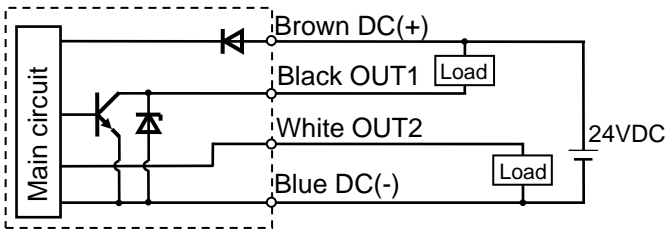

Max.28 V, 80 mA  
Internal voltage drop 1 V max.  
Analogue output 1 to 5 V  
Output impedance 1 KΩ

NPN + Analogue output type

LFE□D□□□

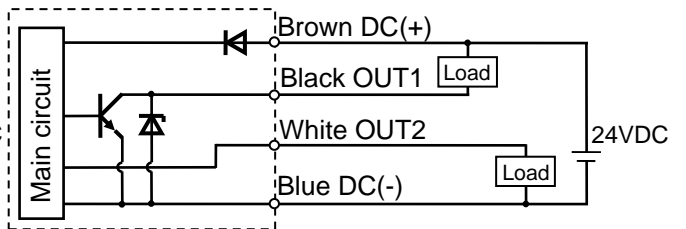

Max.28 V, 80 mA  
Internal voltage drop 1 V max.  
Analogue output 4 to 20mA  
Max. load impedance 600 Ω

## Example of wiring for accumulated pulse output

NPN 2 output type

LFE□A□□□

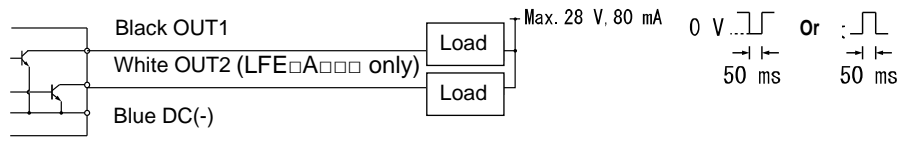

NPN + Analogue output type

LFE□C□□□

LFE□D□□□

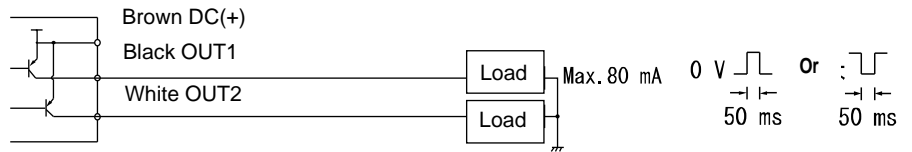

PNP 2 output type

LFE□B□□□

\* When accumulated pulse output is selected, the indicator LED will be turned OFF.



# Flow Setting

## Measurement mode

Measurement mode is the condition where the flow is detected and displayed, and the switch function is operating.

This is the basic mode; other modes should be selected for set-point changes and other function settings.

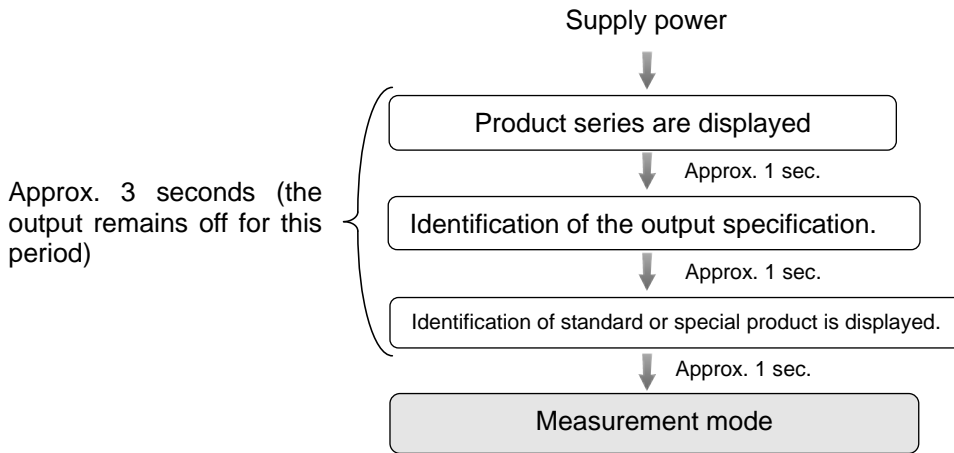

Set ON and OFF points of the switch output.

### - Switch operation

When the flow exceeds the set value, the switch will be turned on.

When the flow falls below the set value by the amount of hysteresis or more, the switch will be turned off.

If the operation shown below is acceptable, then keep these settings.

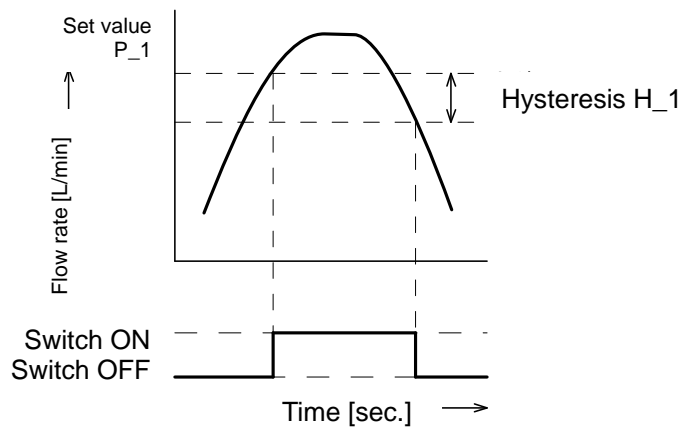

<Operation>

(1) Press the  button once in measurement mode.

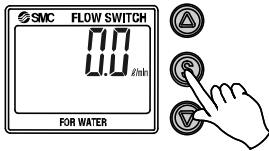

(2) [P\_1] or [n\_1] and the set value are displayed alternately.

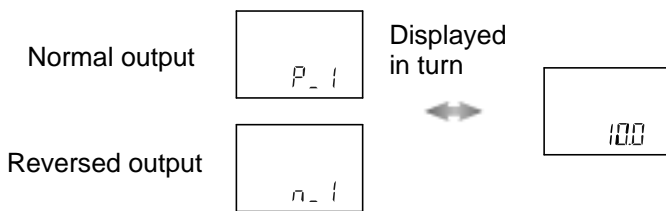

(3) Press the  or  button to change the set value.

The  button is to increase and the  button is to decrease the set value.

- Press the  button once to increase the value by one digit, press and hold to continuously increase.

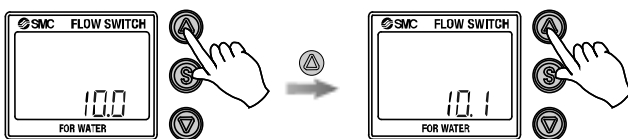

- Press the  button once to reduce the value by one digit, press and hold to continuously reduce.

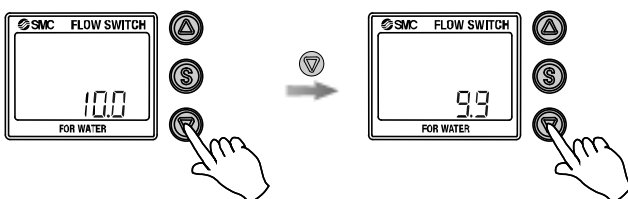

(4) Press the  button to complete the setting.

The Flow switch turns on within a set flow range (from P1L to P1H) during window comparator mode. Set P1L, the lower limit of the switch operation, and P1H, the upper limit of the switch operation, following the instructions given above. When reversed output is selected, the main screen displays [n1L] and [n1H]. When 2 output specification is used, [P\_2] or [n\_2] is displayed. Continue with setting the parameter. (When reversed output is selected, the main screen displays [n\_2]).

\*: If a button operation is not performed for 30 seconds during the change of setting, the set value will start flashing.

# Function Setting

## Function selection mode

In measurement mode, when the **(S)** button is pressed for 2 seconds or longer, [F 1] is displayed. Select to display the function to be changed [F ]. Press and hold the **(S)** button for 2 seconds or longer to return to measurement mode.

\*: The sub

screen displays the content of the function and the function setting in turn.

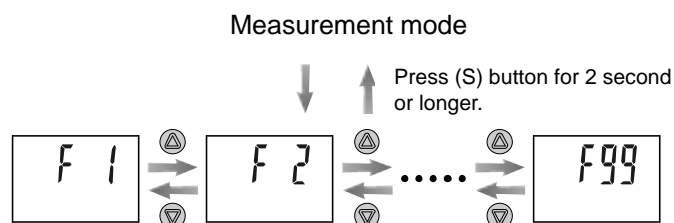

The function is increased and decreased by the **(▲)** and **(▼)** button. Display the required function number and press the **(S)** button.

## ■ Default Setting

The default settings are as follows.

If these settings are acceptable, retain for use.

To change a setting, enter function selection mode (Refer to the table below).

### ■ [F 1] Setting of OUT1 ➡ Page 28

Item	Description	Default setting
Output mode	Selects the switch output type from: Instantaneous flow (either hysteresis or window comparator mode), accumulated flow, accumulated pulse.	Hysteresis mode
Reverse output	Selects which type of switch output is to be used, normal or reversed.	Normal output
Set value	Sets the ON and OFF point of the switch output	50% of rated flow
Hysteresis	Appropriate setting of the hysteresis prevents the switch output from chattering.	5% of rated flow
Display color	Select the color of the main display.	Output ON: Green Output OFF: Red

### ■ [F 2] Setting of OUT2 ➡ Page 36



Item	Description	Default setting
Output mode	Selects the switch output type from: Instantaneous flow (either hysteresis or window comparator mode), accumulated flow, accumulated pulse.	Hysteresis mode
Reverse output	Selects which type of switch output is to be used, normal or reversed.	Normal output
Set value	Sets the ON and OFF point of the switch output	50% of rated flow
Hysteresis	Setting of hysteresis can prevent chattering.	5% of rated flow

\*: Display color is linked to the setting of OUT1, and can not be selected.

## # Other parameter setting

Item	Page	Default setting
[F3] Response time	Page 40	1 sec.
[F10] Sub screen	Page 41	Flow direction
[F20] External input	Page 45	-
[F22] Analogue output	Page 46	Free range analogue output for instantaneous flow: OFF
[F30] Accumulated value display	Page 47	OFF
[F32] Setting of flow direction / back flow detection function.	Page 48	Normal flow, OFF [Does not switch when back flow]
[F33] Close proximity setting	Page 50	FR0
[F34] Zero-reset setting	Page 51	OFF
[F80] Power saving mode	Page 52	OFF (display is turned on)
[F81] Setting of security code	Page 53	OFF
[F82] Input of line name	Page 54	Blank
[F90] Setting of all functions	Page 55	OFF
[F98] Output check	Page 56	OFF
[F99] Reset to the default settings	Page 57	OFF

### Sub screen

In measurement mode, the display of the sub screen can be temporarily changed by pressing the  or  buttons.

\*: After 30 seconds, it will automatically reset to the display selected in [F10]. (page 41)

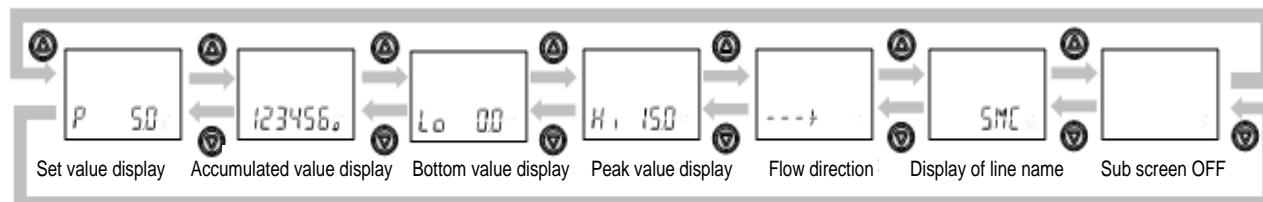

The set values of OUT2 and accumulated output cannot be displayed.  
(Example for 20 L/min type the above)

- [F 1] Setting of OUT1  
Set the output mode of OUT1.

<Function setting Flowchart>

**Selection of output mode**

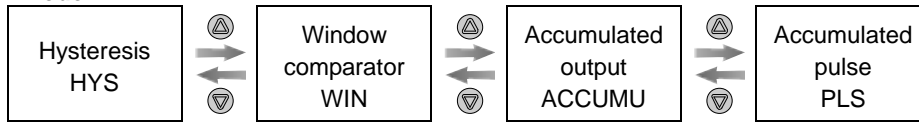

**2. Setting of reversed output**

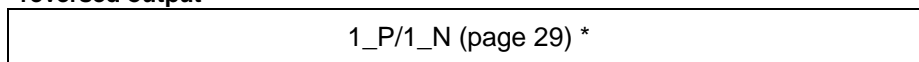

**Input of set values**

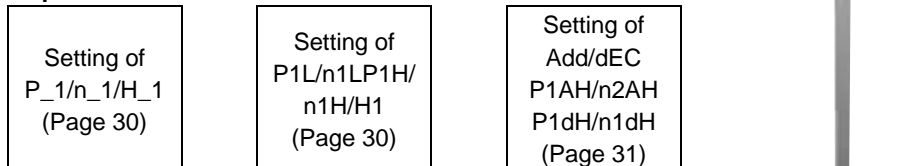

**4 Select display color**



**5. Completed**

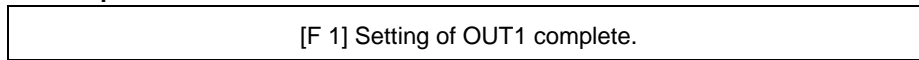

\*: By switching to reversed output, the display color will change in relation to the setting.

<Operation>

### Selection of output mode

Press the or button in function selection mode to display [F 1] on the main screen.

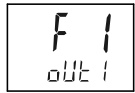

➔ The sub screen alternately displays [oUT1] and the currently set output mode.

↓ Press the button.



➔ Sub screen

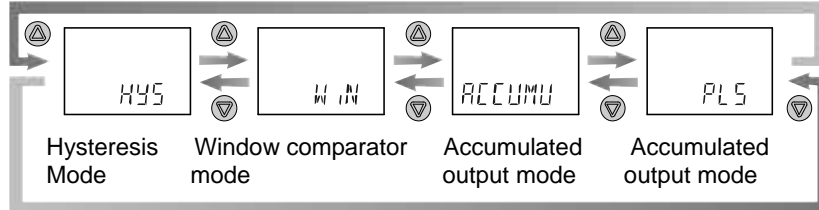

Press the or button to select the desired output mode.

Press the button to set. ↓ Move on to the setting of reversed output.

\*: If a button operation is not performed for 30 seconds during the change of setting, the display will flash.

(This is to prevent the setting from remaining incomplete if, for instance, an operator were to leave during setting.)

\*: When the accumulated pulse output is selected, the output display will turn off.

## 2. Setting of reversed output



➔ Sub screen

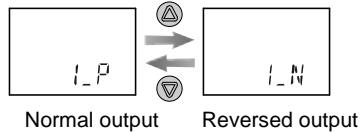

Press the or button to select reversed output mode.

Press the button to set. ↓ Move on to the input of set values(ON-OFF point).

### 3. Input of set values

Output mode

#### a. When hysteresis mode is selected

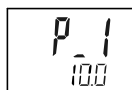

➔ The sub screen displays the set value. Change it with ▲ or ▼ button.  
(When reversed output is selected, the main screen displays [n\_1].)

Press the Ⓢ button to set. ↓ Move on to the setting of hysteresis.

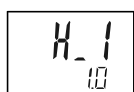

➔ The sub screen displays the hysteresis value. Change it with ▲ or ▼ button.

Press the Ⓢ button to set. ↓ Move on to the selection of display color (page 33).

\*: The set value and hysteresis settings limit each other.

Output mode

#### b. When window comparator output mode is selected.

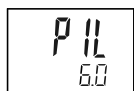

➔ The sub screen displays the set value. Change it with ▲ or ▼ button.  
(When reversed output is selected, the main screen displays [n1L].)

Press the Ⓢ button to set. ↓ Move on to the input of set value for [P1H] or [n1H].

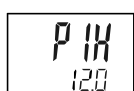

➔ The sub screen displays the set value. Change it with ▲ or ▼ button.  
(When reversed output is selected, the main screen displays [n1H].)

Press the Ⓢ button to set. ↓ Move on to the setting of hysteresis.

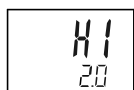

➔ The sub screen displays the hysteresis value. Change it with ▲ or ▼ button.

Press the Ⓢ button to set. ↓ Move on to the selection of display color (page 33).

Output mode

c. When Accumulated output is selected

Selection of accumulated increment (addition) or decrement (subtraction)

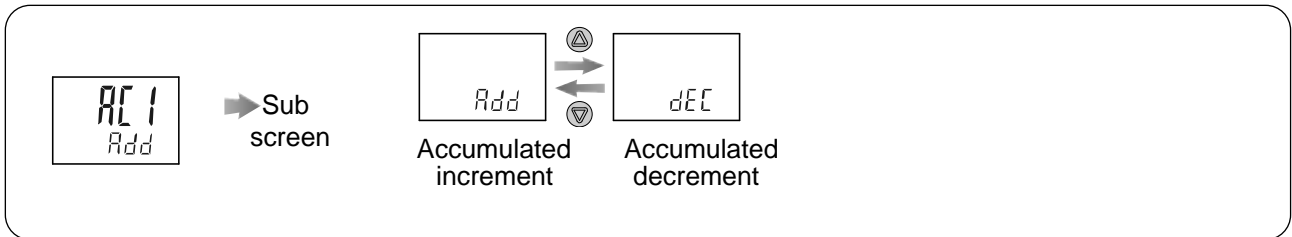

Press the or button to select the desired output mode.

Press the button to set. Move on to the input of set values.

Accumulated increment mode

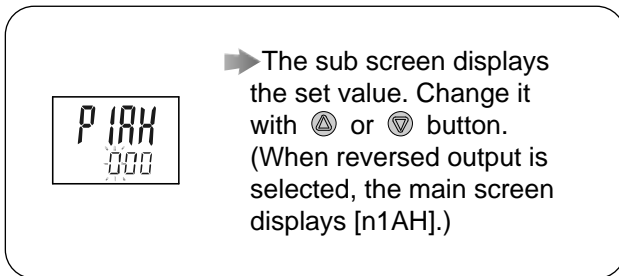

Accumulated decrement mode

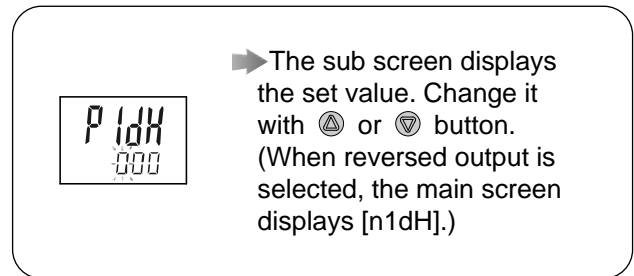

(Continued)



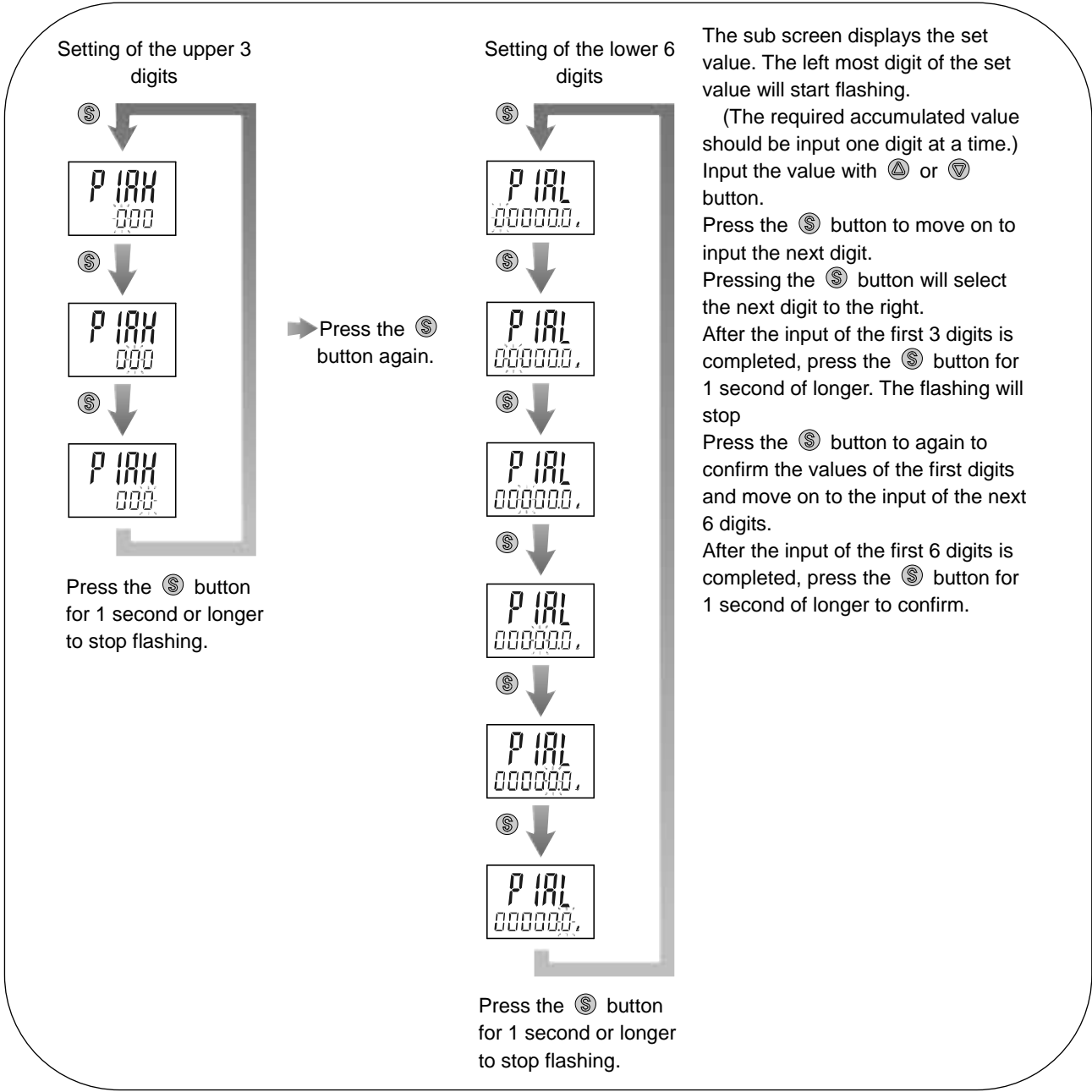

The sub screen displays the set value. The left most digit of the set value will start flashing.

(The required accumulated value should be input one digit at a time.) Input the value with [▲] or [▼] button.

Press the [S] button to move on to input the next digit.

Pressing the [S] button will select the next digit to the right.

After the input of the first 3 digits is completed, press the [S] button for 1 second of longer. The flashing will stop

Press the [S] button to again to confirm the values of the first digits and move on to the input of the next 6 digits.

After the input of the first 6 digits is completed, press the [S] button for 1 second of longer to confirm.

Press the [S] button to set. ↓ Move on to the selection of display color.

#### 4 Select display color

The display color can be set to change depending upon the status of OUT1.

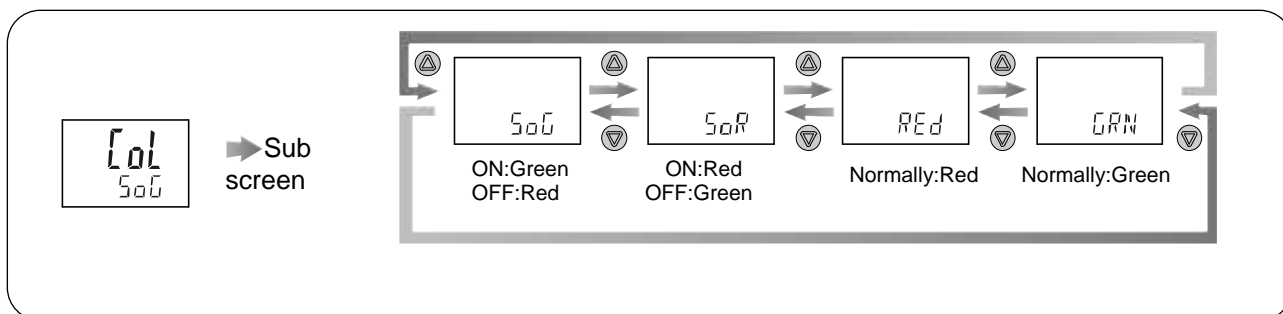

Press the or button to select the display color.

Press the button to set. Return to function selection mode.

#### 5. Completed

[F 1] Setting of OUT1 complete.

# List of output mode

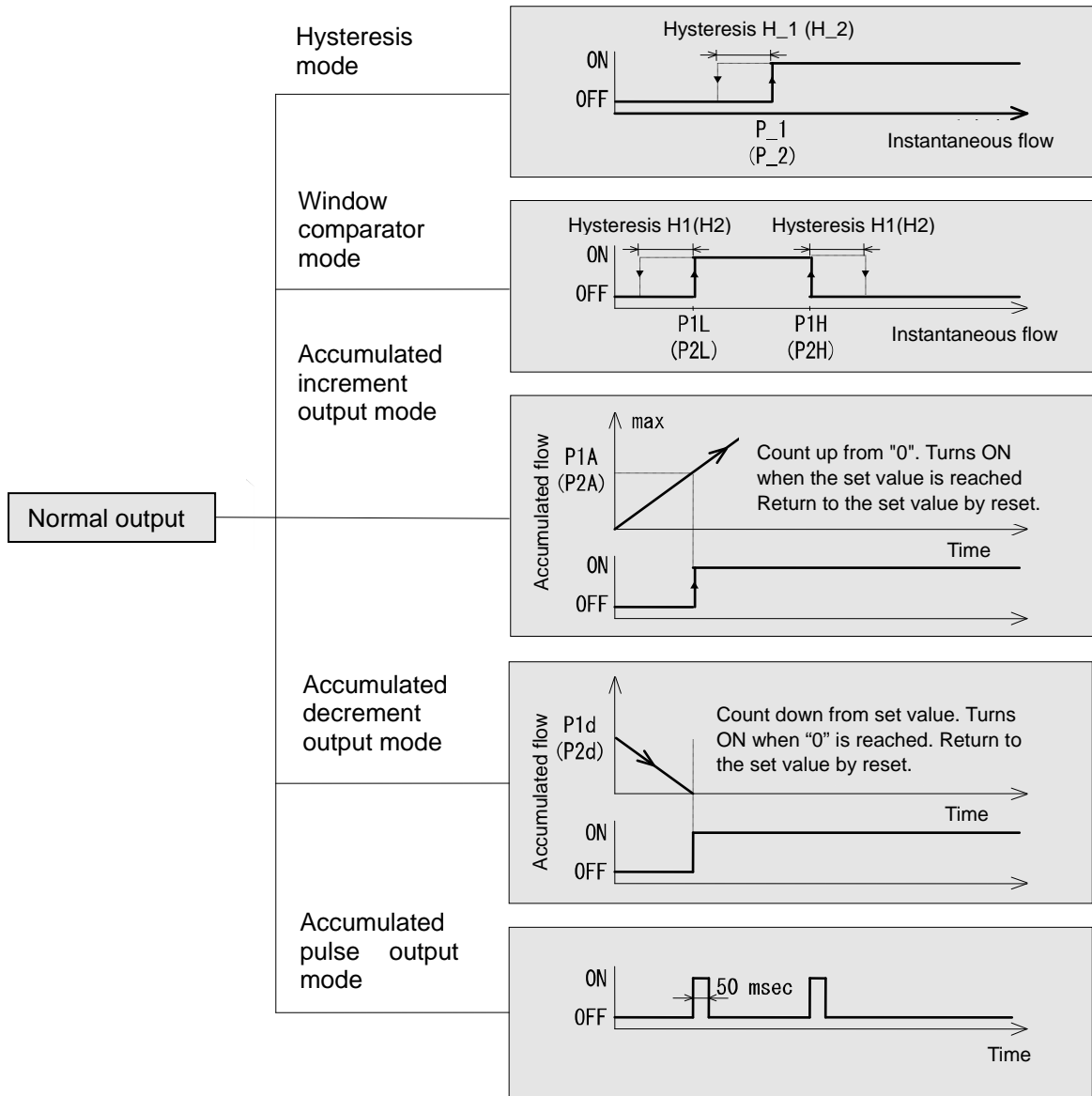

\*: If hysteresis or window comparator mode are selected during unstable flow conditions (due to fluid pulsation, for example), unstable output operation can result.

In such situations, keep sufficient margin between the set values and confirm that the output operation stabilizes.

\*: When the accumulated pulse output is selected, the output display will turn off.

\*: Refer to page 49 when detection function is used for reverse flow.

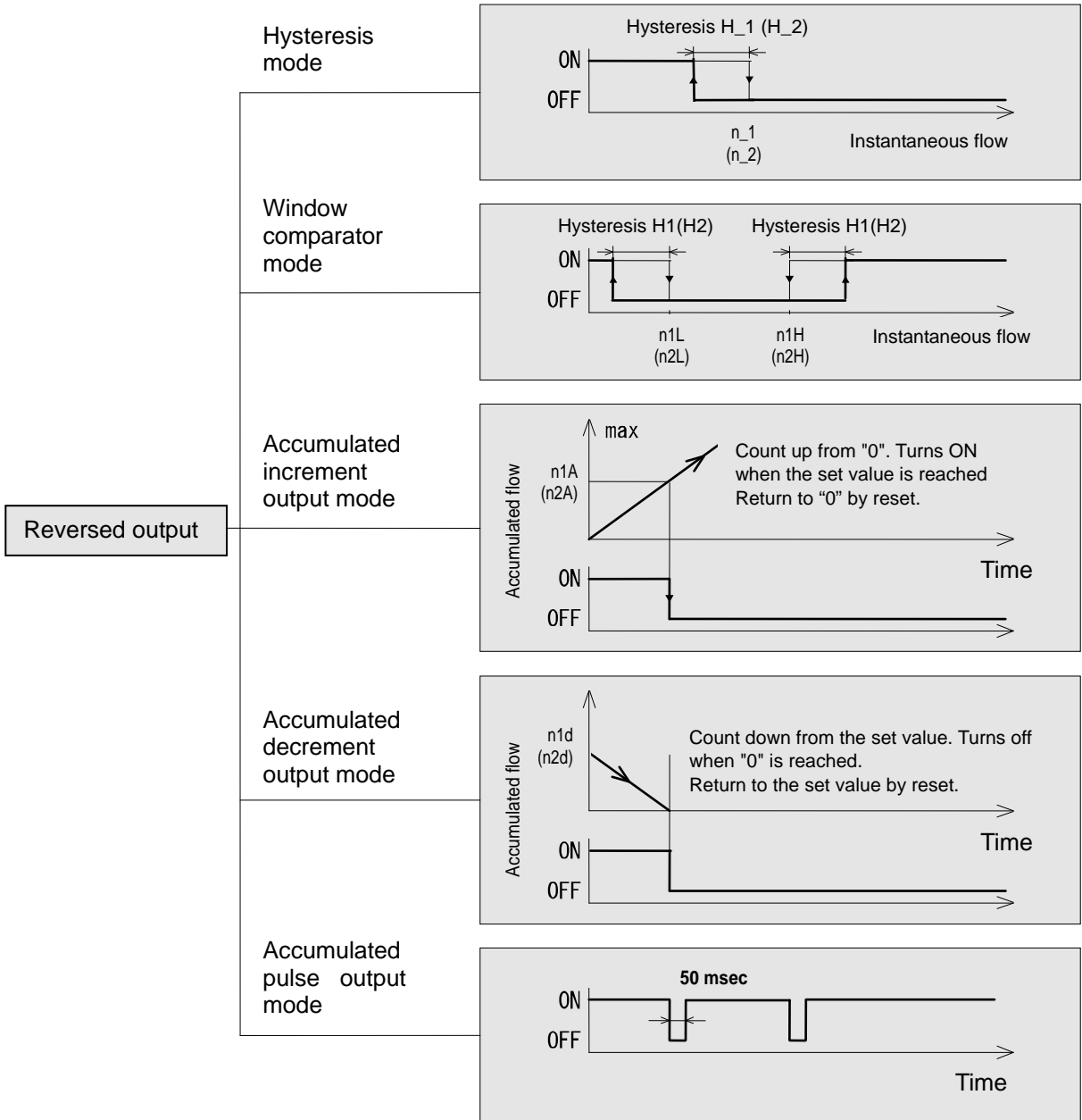

■ [F 2] Setting of OUT2

Set the output mode of OUT2.

The display color is defined by OUT1 and cannot be changed with any OUT2 settings

<Function setting Flowchart>

**Selection of output mode**

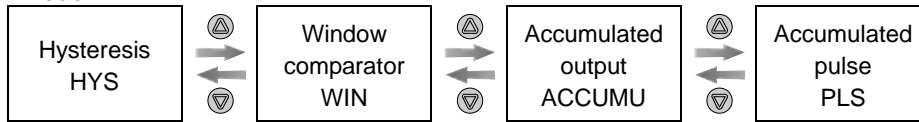

**Setting of reversed output**

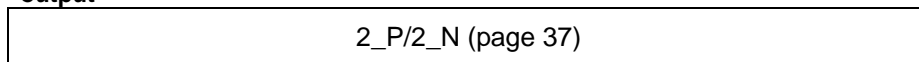

**Input of set values**

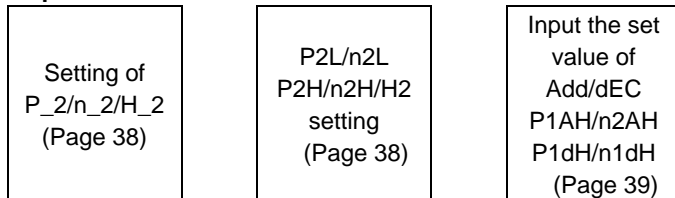

**4 Select display color**

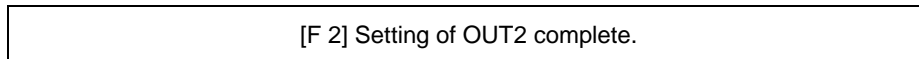

<Operation>

### 1. Selection of output mode

Press the or button in function selection mode to display [F 2] on the main screen.

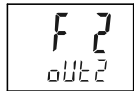

➔ The sub screen displays [oUt2] and the currently set output mode alternately.  
\*: If OUT2 is not provide, the display will be [---].

↓ Press the button.

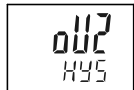

↓ Sub screen

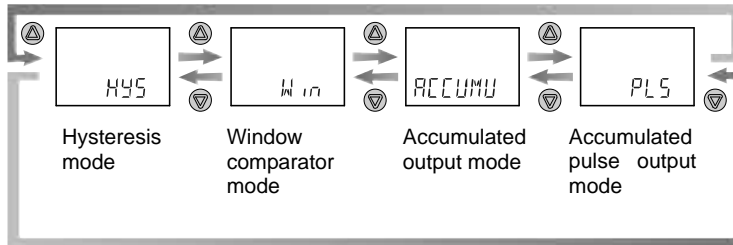

Press the or button to select the desired output mode.

Press the button to set. ↓ Move on to the setting of reversed output.

### 2. Setting of reversed output

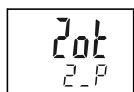

➔ Sub screen

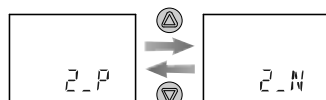

Normal output    Reversed output

Press the or button to select reversed output mode.

Press the button to set. ↓ Move on to the input of set values (ON-OFF point).

### 3. Input of set values

Output mode

#### a. When hysteresis mode is selected



➔ The sub screen displays the set value. Change it with ▲ or ▼ button.  
(When reversed output is selected, the main screen displays [n\_2].)

Press the Ⓢ button to set. ↓ Move on to the setting of hysteresis.

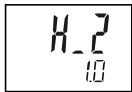

➔ The sub screen displays the hysteresis value. Change it with ▲ or ▼ button.

Press the Ⓢ button to set. ↓ Return to function selection mode.

#### 4. Completed

[F 2] Setting of OUT2 complete.

\*: The set value and hysteresis settings limit each other.

Output mode

#### b. When window comparator output mode is selected.

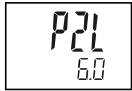

➔ The sub screen displays the set value. Change it with ▲ or ▼ button.  
(When reversed output is selected, the main screen displays [n2L].)

Press the Ⓢ button to set. ↓ Move on to the input of set value for [P2H] (or [n2H])

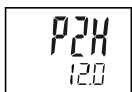

➔ The sub screen displays the set value. Change it with ▲ or ▼ button.  
(When reversed output is selected, the main screen displays [n2H].)

Press the Ⓢ button to set. ↓ Move on to the setting of hysteresis.



➔ The sub screen displays the hysteresis value. Change it with ▲ or ▼ button.

Press the Ⓢ button to set. ↓ Return to function selection mode.

#### 4. Completed

[F 2] Setting of OUT2 complete.

## Output mode

### c. When Accumulated output is selected

Selection of accumulated increment or decrement

Switching of Add/dEC is linked to the setting of OUT1, and cannot be selected. (Refer to page 31)

#### Accumulated increment mode



➡ The sub screen displays the set value. Change it with ▲ or ▼ button. (When reversed output is selected, the main screen displays [n2AH].)

#### Accumulated decrement mode



➡ The sub screen displays the set value. Change it with ▲ or ▼ button. (When reversed output is selected, the main screen displays [n2dH].)

For details, refer to c. When accumulated output mode is selected" on (page 32)

Press the Ⓢ button to set. ↓ Return to function selection mode.

#### 4. Completed

[F 2] Setting of OUT2 complete.



### ■[F3] Response time

The response time of the switch output can be set.

Appropriate setting of the response time can prevent the switch output from chattering.

#### <Operation>

Press the or button in function selection mode to display [F 3] on the main screen.

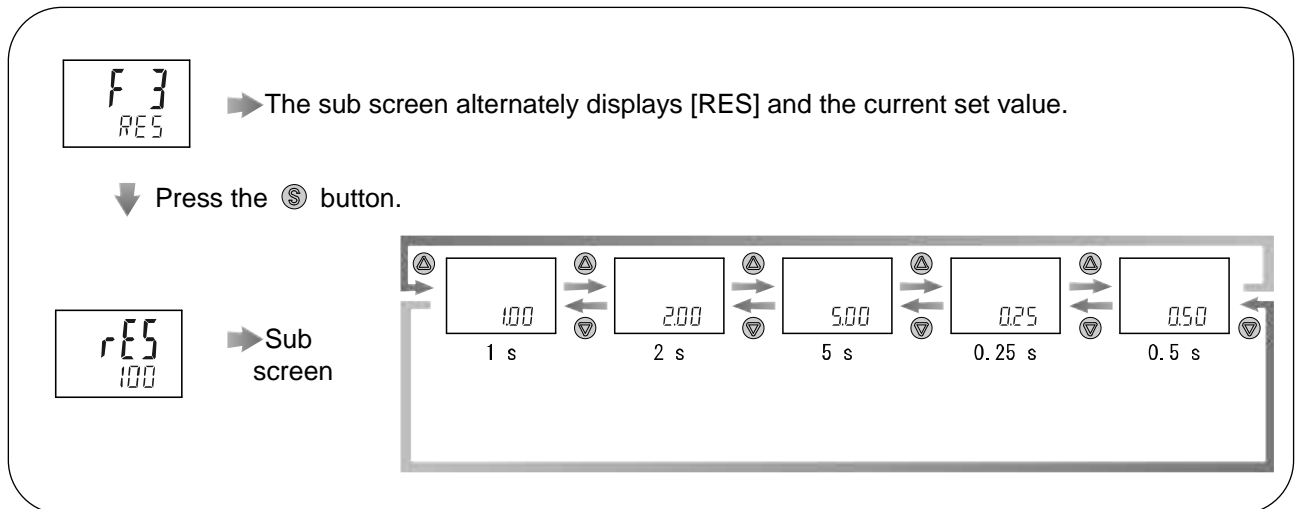

Press the or button to select the response time.

Press the button to set. Return to function selection mode.

[F3] Response time setting complete.

■[F10] Sub screen display

The sub display indication during measurement mode can be selected from the following:

- Set value display: Displays the set value of OUT1 (The set values of OUT2 cannot be displayed.)
- Accumulated flow display: Displays the accumulated flow of OUT1 (The accumulated flow of OUT2 cannot be displayed.)
- Bottom display: The bottom value of fluid is displayed.
- Peak display: The peak value of fluid is displayed.
- Flow direction display: Direction of the flow to be measured is displayed.  
(In the close proximity setting mode, the set value is displayed at the same time.)
- Line name display: Displays the line name
- OFF: Displays nothing

<Operation>

Press the or button in function selection mode to display [F10] on the main screen.

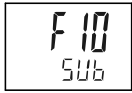

➔ The sub screen alternately displays [Sub] and the current set value.

↓ Press the button.



➔ The sub screen displays the current set value.

↓ Sub screen

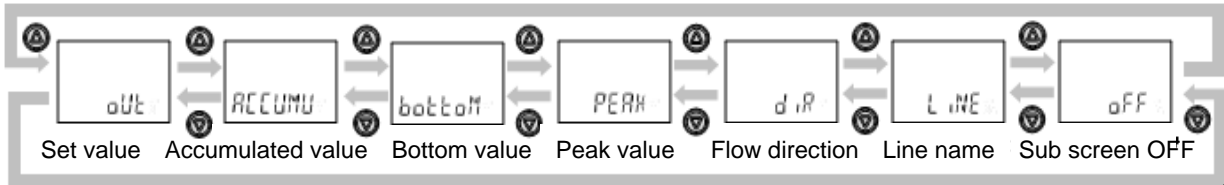

Press the or button to select the desired display.

Press the button to set. ↓ Return to function selection mode.

[F10] Selection of sub screen complete.

<Example of sub screen display>

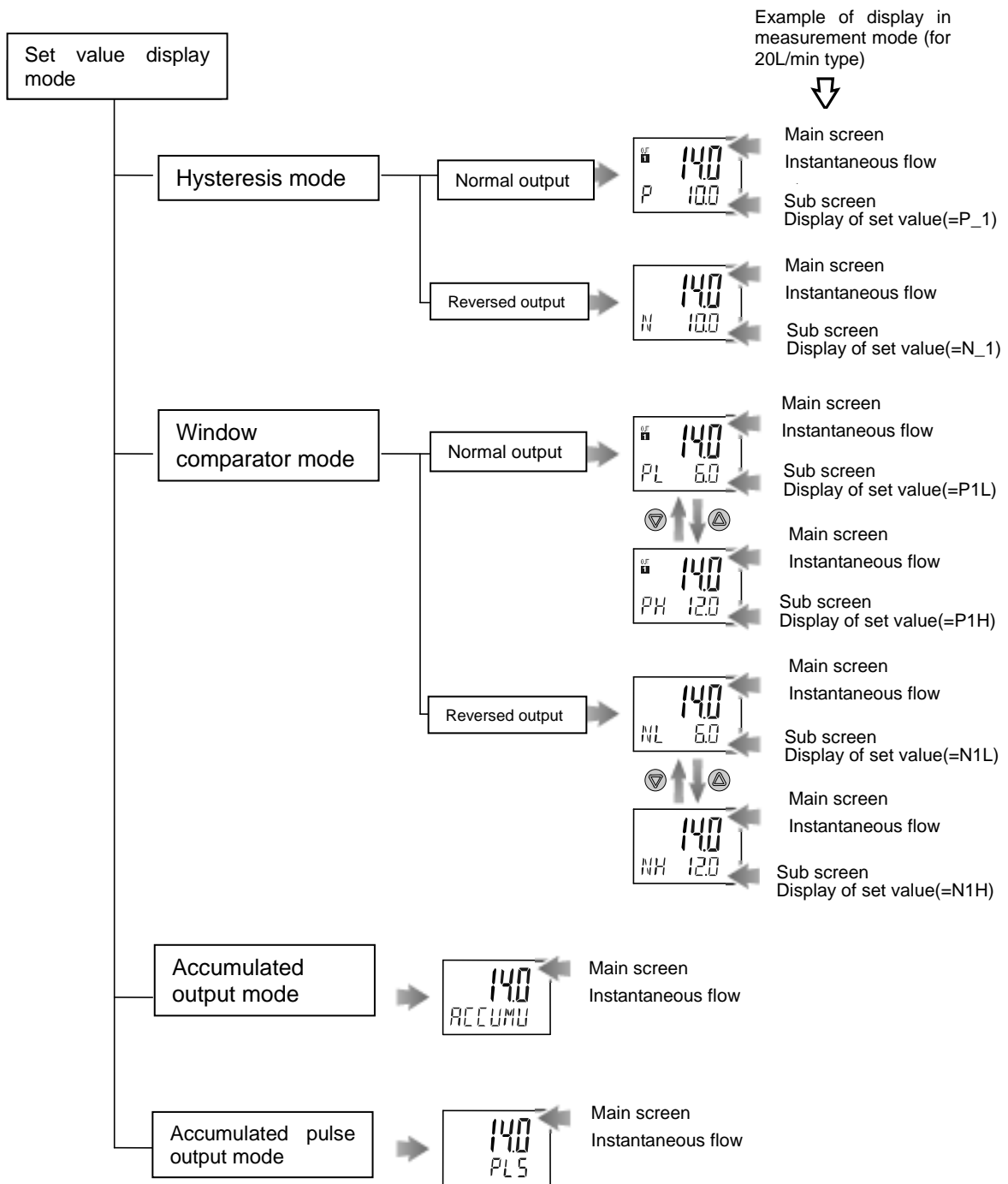

<Example of sub screen display (continued)>

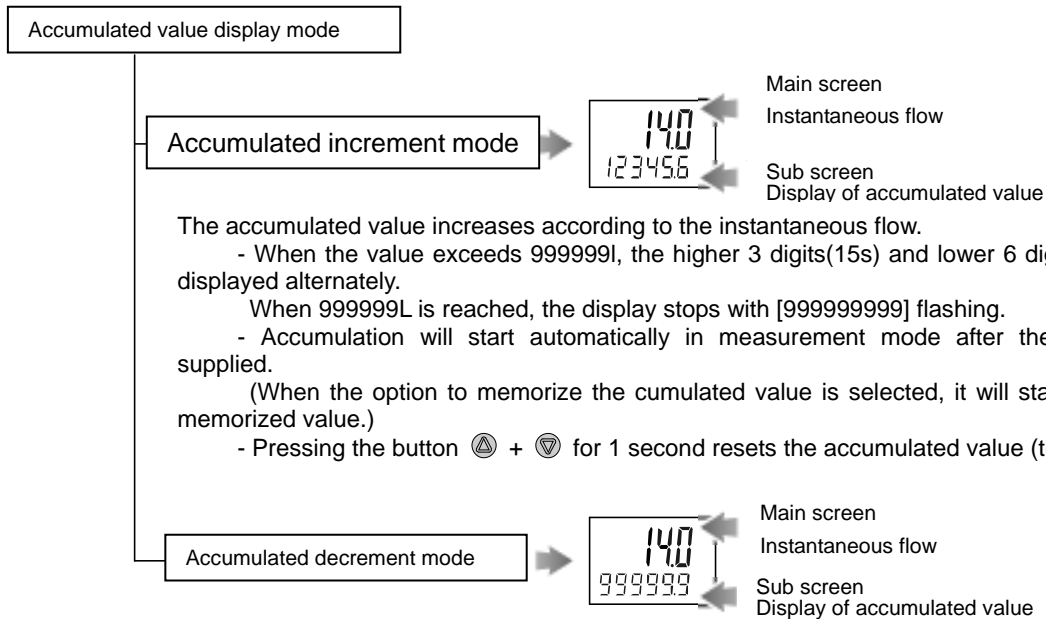

The accumulated value increases according to the instantaneous flow.

- When the value exceeds 999999L, the higher 3 digits(15s) and lower 6 digits(3s) are displayed alternately.
- When 999999L is reached, the display stops with [99999999] flashing.
- Accumulation will start automatically in measurement mode after the power is supplied.
- (When the option to memorize the cumulated value is selected, it will start from the memorized value.)
- Pressing the button  $\Delta$  +  $\nabla$  for 1 second resets the accumulated value (to -0).

The cumulative value decreases from the set value according to the instantaneous flow.

- When the value exceeds 999999L, the higher 3 digits(1.5s) and lower 6 digits(3s) are displayed alternately.
- Below 999999L, only the lower 6 digits are displayed.
- When the accumulated value decreases to 0, the display stops with [0] flashing.
- Accumulation will start automatically in measurement mode after the power is supplied.
- (When the option to memorize the cumulated value is selected, it will start from the memorized value.)
- Pressing the button  $\Delta$  +  $\nabla$  for 1 second resets the accumulated value (returns to the set value).

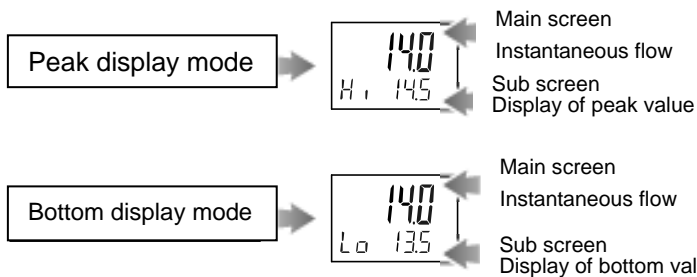

Displays the maximum flow rate (= peak value) or minimum flow rate (= bottom value) from the time power is supplied to current time.

Pressing  $\Delta$  +  $\nabla$  for 1 second clears the peak and bottom.

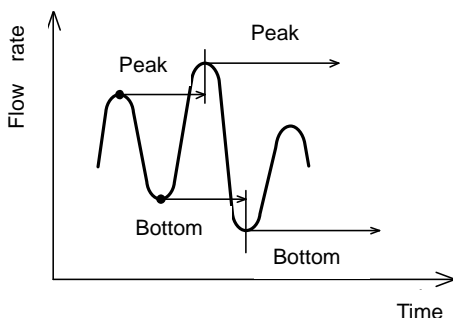

<Example of sub screen display (continued)>



Select the fluid direction

Pressing + buttons for 1 second possible to change the close proximity setting.

Normal flow

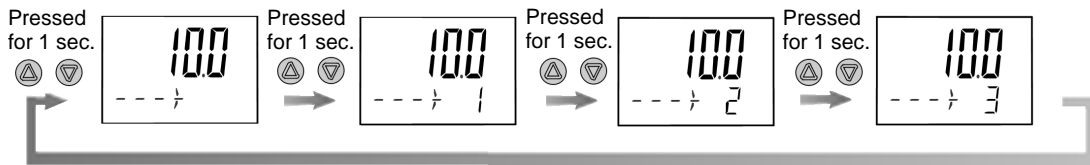

Reverse flow

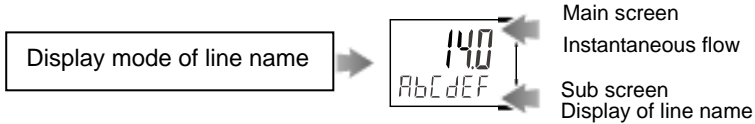
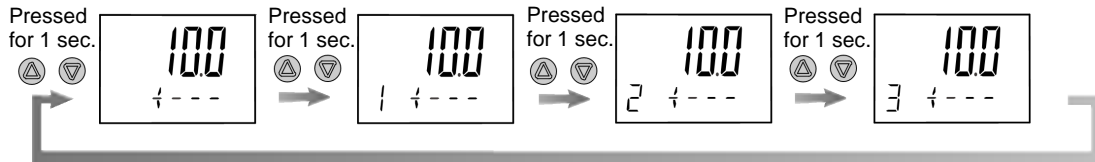

The name of the piping line where the product is installed can be displayed.

Refer to [F82] Input of line names on page for how to input the line name (page 54).

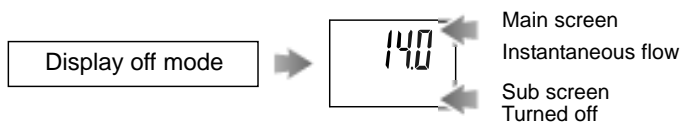

The sub display can be turned off.

- [F 20] External input  
This item is not used for this specification.

■ [F22] Analogue output

This function can be used only when the optional analogue output is present.

The flow that generates the output voltage (=5V) or output current (=20mA) at the span side of analogue output can be variable.

<Operation>

Press the or button in function selection mode to display [F22] on the main screen.



➔ The sub screen alternately displays [AnA] and the current set value.

\*: If the analogue output is not present, the sub screen alternately displays [AnA] and [- - -].

↓ Press the button.

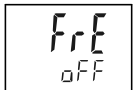

➔ Sub screen

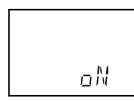

Free range ON

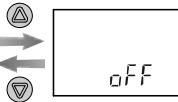

Free range OFF

Press the button.

OFF

ON



➔ Sub screen

Use the + buttons to enter the flow value that will generate 5V or 20mA. The selected flow value can be within the range: 10% of the rated flow, to the upper display limit.

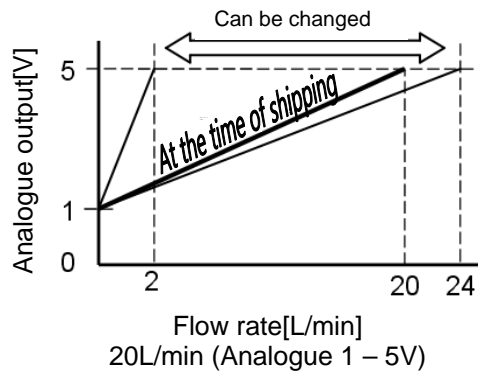

Press the button to set. ↓ Return to function selection mode.

[F22] Setting of analogue output complete.

■[F30] Accumulated value display

The default setting is to clear the accumulated flow value when the power supply is turned off. In the default setting, the accumulated flow value is not held when the power supply is turned off. The maximum writable limit of the memory device is 1 million cycles, which should be taken into consideration.

If the product is operated 24 hours per day, the product life will be as follows:

Data memorized every 5 minutes --- 5 minutes x 1 million cycles = 5 million minutes = 9.5 years

Data memorized every 2 minutes --- 2 minutes x 1 million cycles = 2 million minutes = 3.8 years

<Operation>

Press the  $\Delta$  or  $\nabla$  button in function selection mode to display [F30] on the main screen.

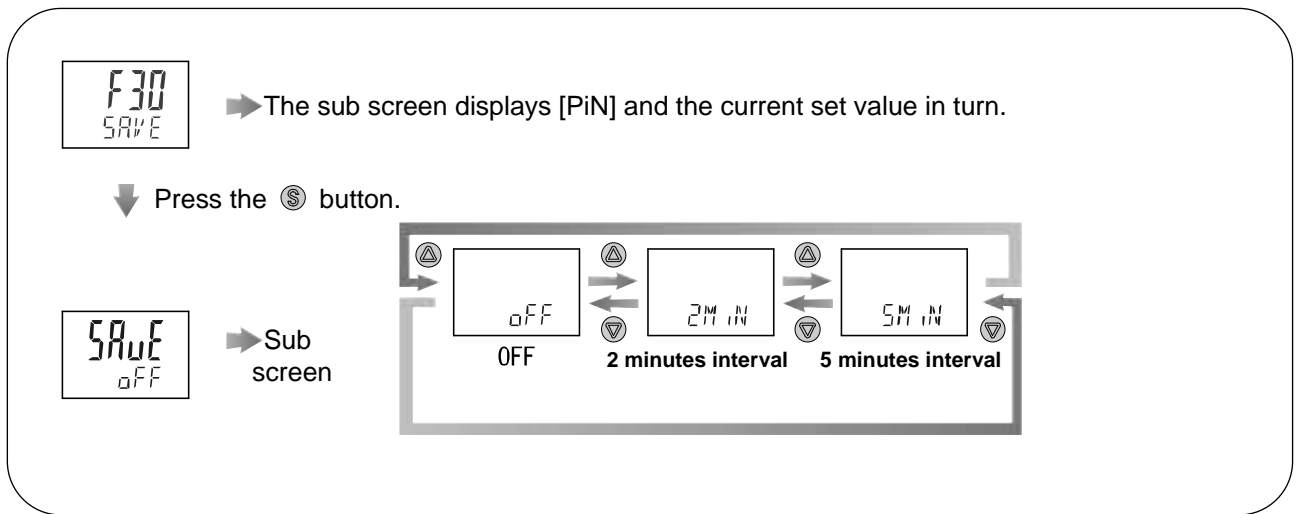

Press the  $\Delta$  or  $\nabla$  button to select the accumulate value hold.

Press the [S] button to set. Return to function selection mode.

[F 30] Setting of accumulated value display complete.

\*: Data is stored every 2 or 5 minutes (depending upon the setting chosen). This means that the accumulated flow value for up to 2 or 5 minutes before the power supply is turned off will not be added to the device memory.

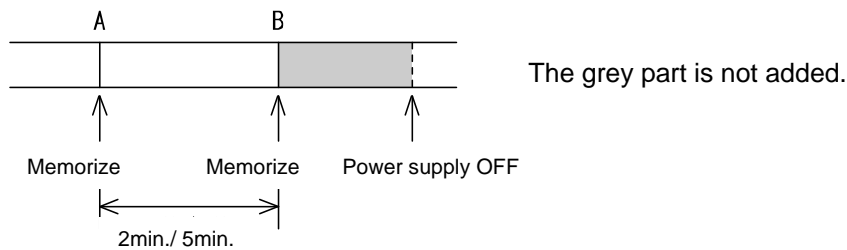

When the power supply is turned on again, the accumulated flow count will start from the last value recorded at B





## ■ [F32] Flow direction setting

With initial setting, the flow direction is from left to right (when the product is viewed from the display side). If the flow direction is changed (right to left) after installing the product, setting is changed.

<Operation>

### 1. Flow direction

Press the  or  button in function selection mode to display [F32] on the main screen.



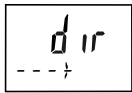

➡ The sub screen displays [diR] and the current set value in turn.

↓ Press the  button.

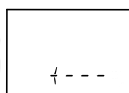
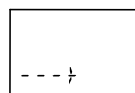

➡ Sub screen



Press the  or  button to select the flow direction.

Press the  button to set. ↓ Moves on to the setting for detection function during reverse flow.

## 2. Selection of the detection function during reverse flow

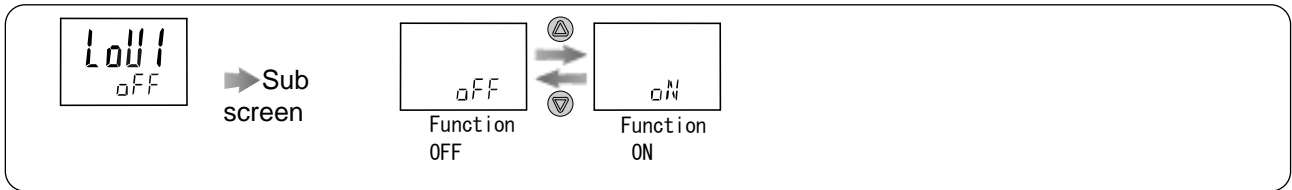

Press the  $\Delta$  or  $\nabla$  button to select the setting.

Press the  $\$$  button to set.  $\downarrow$  Return to function selection mode.

[F 32] Selection of sub screen complete.

You can select reversed output for OUT1 when reversed flow is detected (LLL is displayed). Only OUT1 can be selected. Hysteresis mode and window comparator mode can be selected as output mode.

The output is reversed when the function ON is selected.

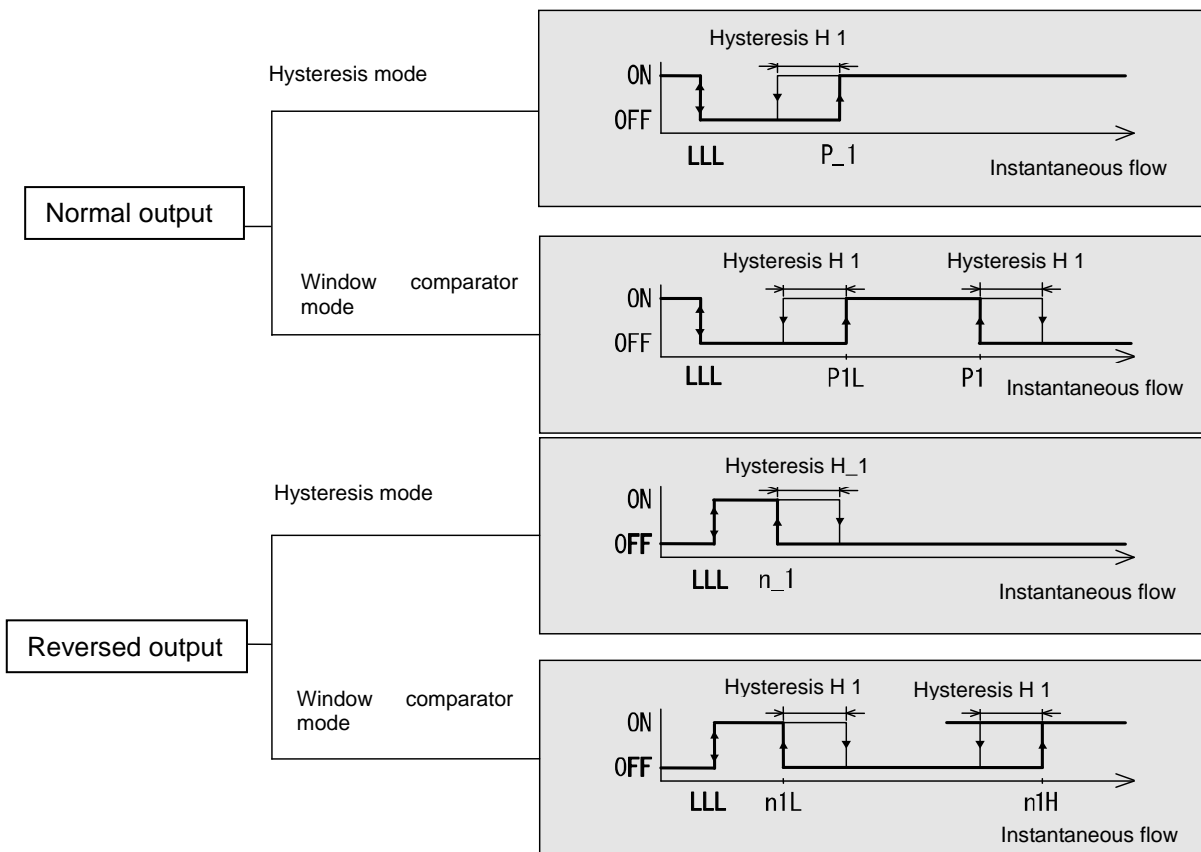

■[F33] Close proximity setting

Use this setting when multiple products are installed close together (inside the area not suitable for mounting) to adjust the display frequency.

<Operation>

Press the ▲ or ▼ button in function selecting mode to display [F33] on the main screen.

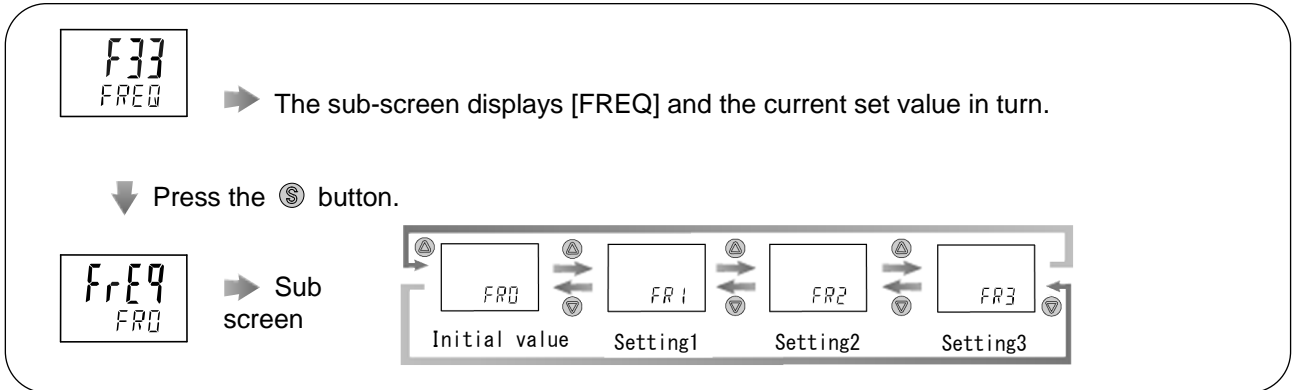

Press the ▲ or ▼ button to select the mode.

Press the Ⓢ button for setting. ↓ Return to the function selection mode.

[F33] Setting of close proximity complete.

■ [F34] Zero-reset setting

This setting is used to adjust the displayed value to zero.

Ensure that the detection passage is filled, with no flow.

Maintain this condition for 1 minute or more. Then move on to the following operation.

<Operation>

Press the or button in function selecting mode to display [F34] on the main screen.

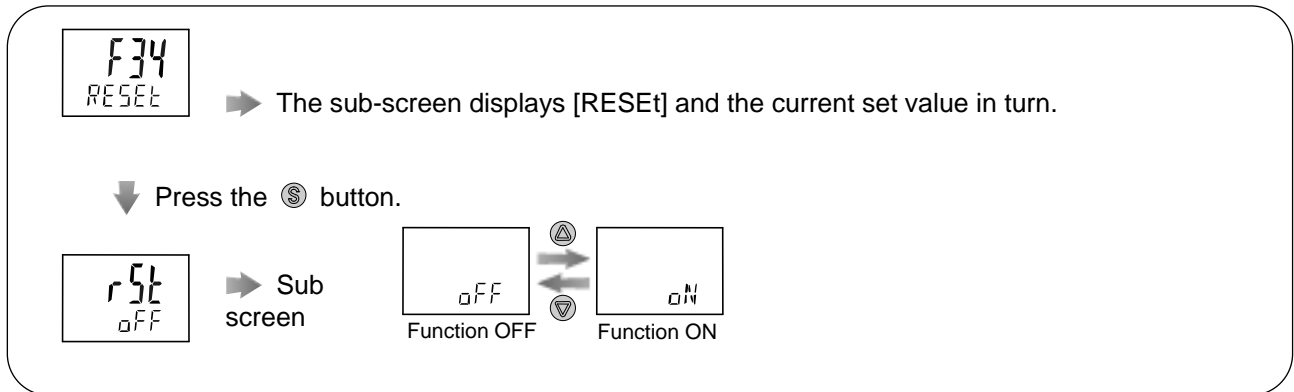

The Zero-reset function is available when the or button is pressed and "ON" is displayed.

Press the and button for more than 2 seconds simultaneously to execute the zero-reset function.

\* : Press the button for more than 1 second, to return to measurement mode with no change of setting.

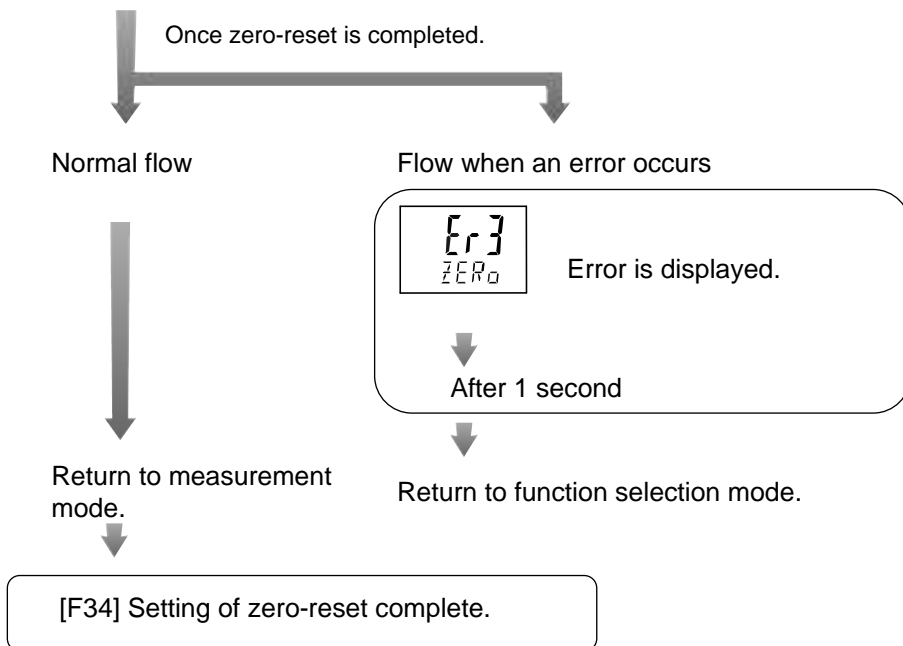

■[F80] Power saving mode



The display can be turned off to reduce power consumption. (Reduced by approx. 10%)

When this function is selected, if no buttons are pressed for 30 seconds, the display will enter power saving mode.



While the display is off, the decimal points of the main display will flash.

In the default setting, power saving mode is ON (normal mode).

<Operation>

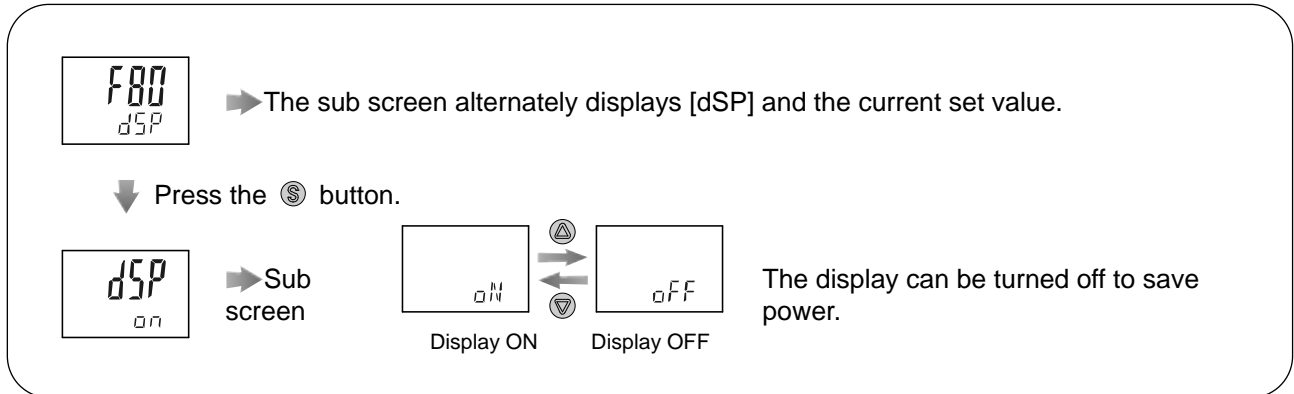
Press the  or  button in function selection mode to display [F80] on the main screen.



Press the  or  button to select the power saving mode setting.

Press the  button to set.  Return to function selection mode.

[F80] Setting of power saving mode complete.

In power saving mode, the decimal points on the main display will flash.

When any button is activated, the display will turn on. If no button operation is performed within 30 seconds, the display will turn off again.



## ■ [F81] Security code

A security code can be selected, which must be entered to unlock the keys.

For the key-lock function, refer to page 58.

In the default setting, entry of a security code number is not required.

### <Operation>

Press the  or  button in function selection mode to display [F81] on the main screen.

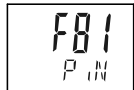

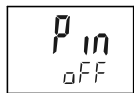

➔ The sub screen displays [PiN] and the current set value in turn.

↓ Press the  button.

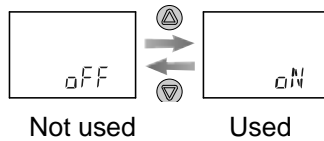

➔ Sub screen



Press the  or  button to select the security code.

Press the  button to set. ↓ Return to function selection mode.

[F 81] Setting of security code complete.



■ [F90] Setting of all functions

All functions can be set one after the other, without having to select each one separately from the function selection mode.

<Operation>

Press the or button in function selection mode to display [F90] on the main screen.

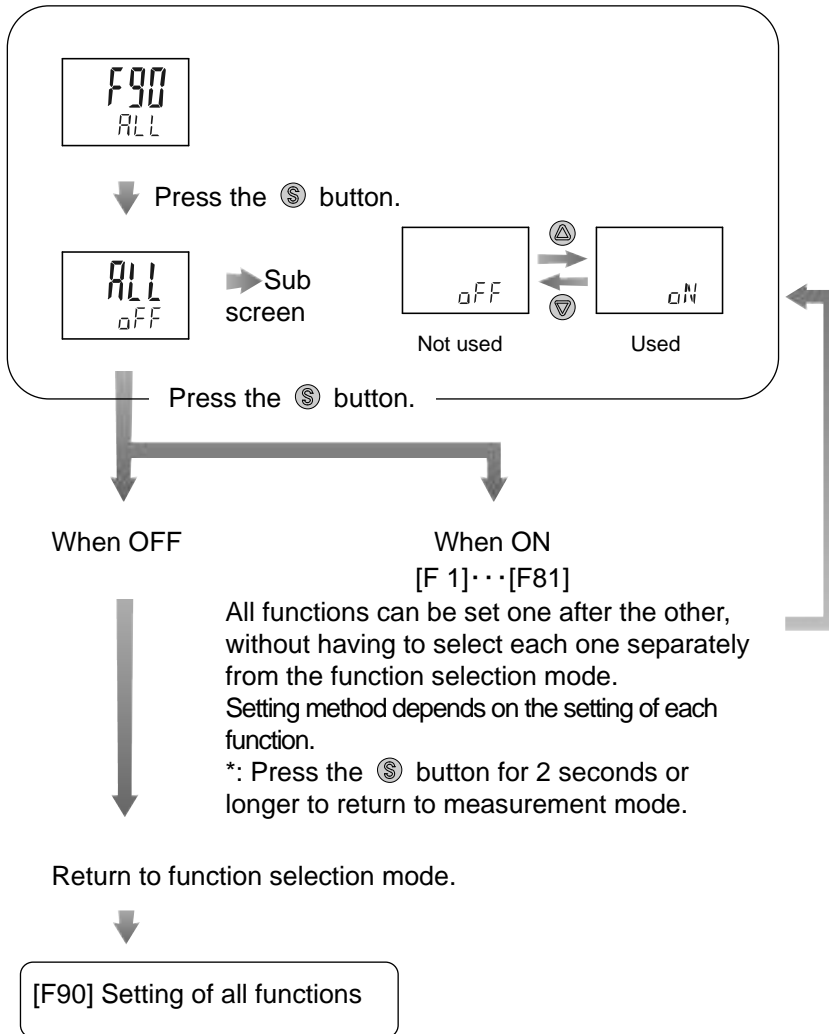



■ [F98] Output check

Forced output to test the product and the wiring.

For the analogue output type: When ON the output will be 5 V or 20 mA , and when OFF 1 V or 4 mA.

<Operation>

Press the or button in function selection mode to display [F98] on the main screen.

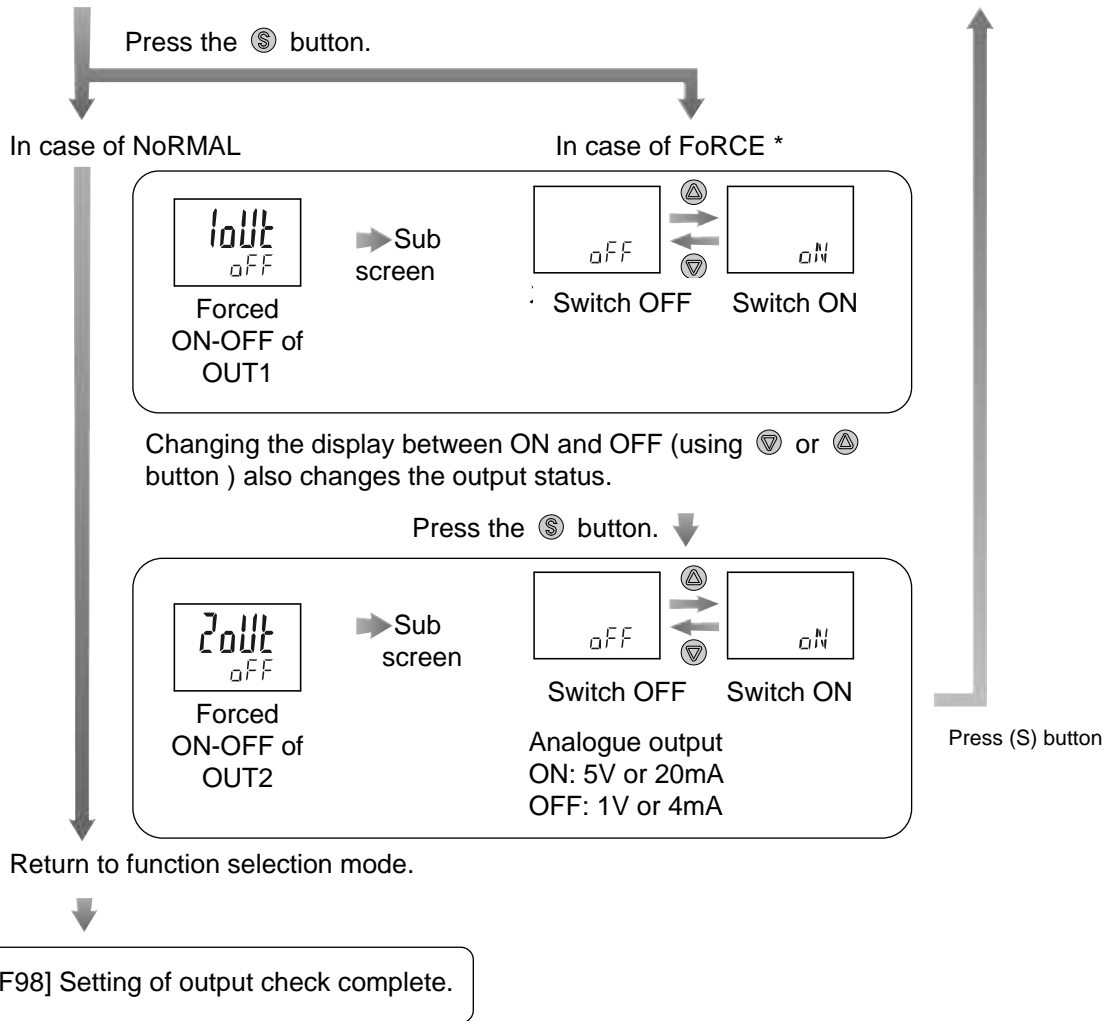
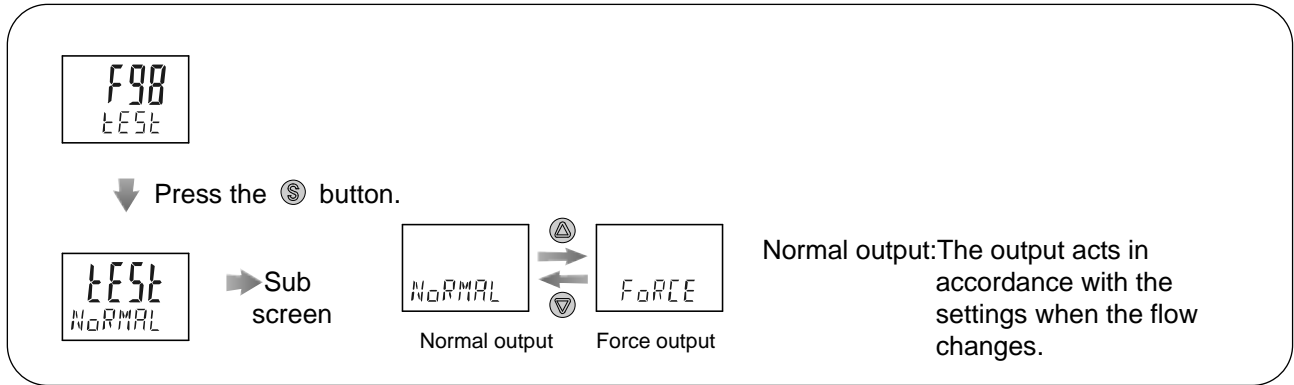



\*: Press the button for 2 seconds or longer to return to measurement mode.

\*: An increase or decrease in flow will have no effect on the output while the output check is being performed.



## ■[F99] Reset to the default settings

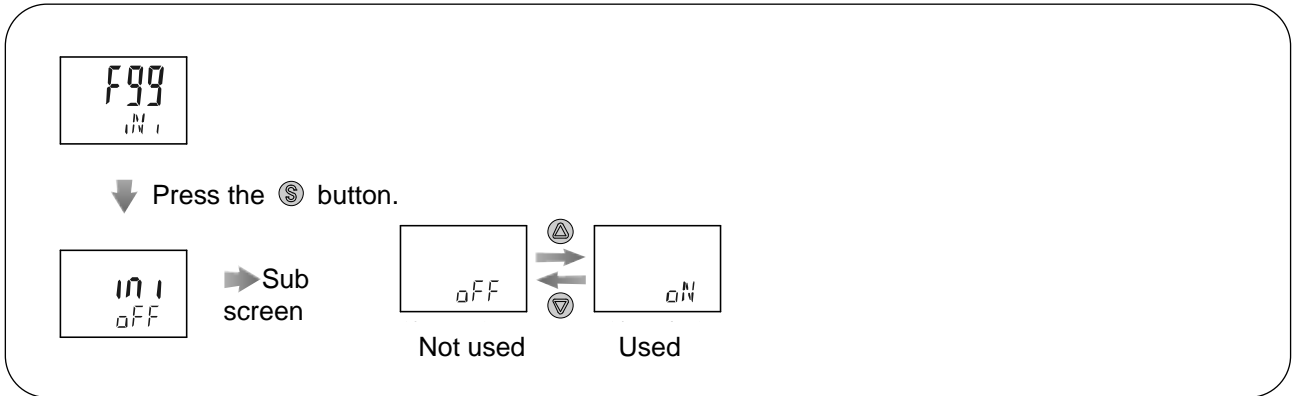

The product can be returned to the default settings.

<Operation>

Press the  or  button in function selection mode to display [F99] on the main screen.



Press the  or  button to display "ON".

Press the  and  button simultaneously for 5 seconds to restore the default settings.

\*: Press the  button for 1 second or longer, the display returns to measurement mode without changing the setting.

The device automatically returns to function selection mode.

[F99] Reset to the default settings complete.

## Other Settings

- Key-lock function

The key-lock function is used to prevent errors occurring due to unintentional changes of the set values. During key lock setting, it is possible to change the display (simple display of set value <--> sub screen )

< Procedure for key-lock setting >

**Quick check of the set value**

[LoC] appears for 1 second by pressing the  button.

When the  button is released with [LoC] displayed, the sub screen will scroll through the set values. After the scrolling of set values is finished, [LoC] is displayed for approx. 1 second, the Flow switch then returns to measurement mode.

Pressing the  or  buttons will change the sub screen display.



The peak and bottom hold values and the accumulated flow can be viewed, but not cleared.

< Operation – Without security code input >

(1) Press the  button for 5 seconds or longer in measurement mode.

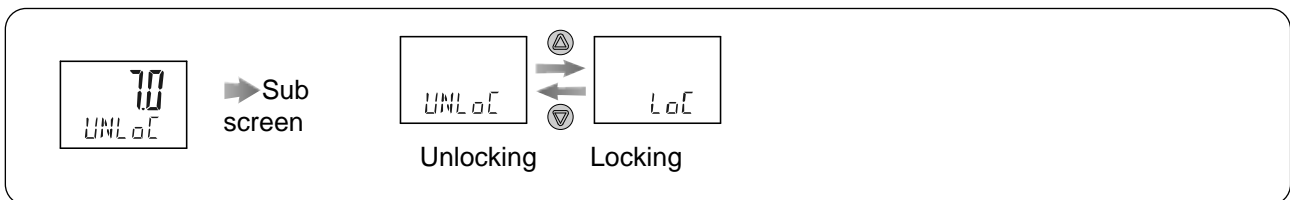
The current setting “LoC” or “UnLoC” will be displayed on the sub screen.



(2) Press the  or  button to select between locking and unlocking the keys.

(3) Press the  button to select the setting. Return to measurement mode.

To release key-lock, repeat the above operation

\*: During simple display of the set value, setting and release of key-lock is not available. Operate in measurement mode.

< Operation – With security code input >

The procedure to lock the keys is the same as that for "without security code".

- Unlocking

(1) Press the  button for 5 seconds or longer in measurement mode.

[LoC] will be displayed on the sub display.

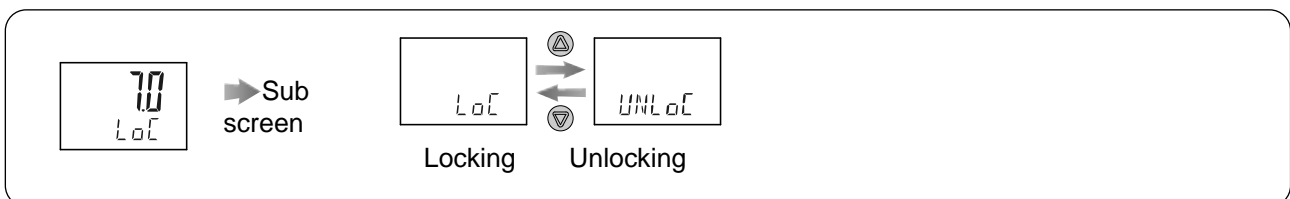

(2) Press the  or  button to select unlocking [UnLoC].

(3) After the  button is pressed, the security code must be entered.

(4) Input of security code (3 digit setting)

The first digit will start flashing.

Press the ▲ or ▼ button to change the value.

Press the Ⓢ button to make the next value to the right flash.

(If the Ⓢ button is pressed on the far right digit, the hundreds digit will flash)

After the input is complete, press and hold the Ⓢ button for 1 second or longer.

(If no key operation is performed for 30 seconds during input or change of the security code, the display will return to measurement mode with LoC status.)

If the security code entered is wrong, [FAL] will be indicated on the sub display.

In this case, retry inputting the security code.

If an incorrect security code is entered 3 times, the display will return to measurement mode with LoC status.

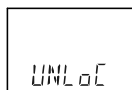
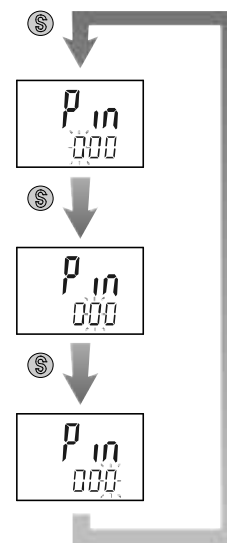

➡ [UnLoC] is displayed on the sub screen.



Press the Ⓢ button to complete the unlocking operation.

■ Change of security code

In the default setting, the security code is set to [000], but this can be changed to any number.

<Operation>

(1) After the key lock setting is completed, perform all four steps in the key unlocking procedure.

(Refer to page 58, Key-lock function)

(2) When [UnLoC] is displayed in the sub screen, press the Ⓢ and ▼ button simultaneously for 5 seconds or longer.

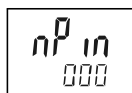

➡ [000] is displayed on the sub screen and the new security code should be entered. Refer to page 59, (4) for input method.

↓ Press the Ⓢ button for 1 seconds or longer.

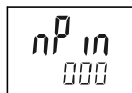

➡ The new security code is displayed on the sub screen.

↓ Press the Ⓢ button for 1 seconds or longer.

The change of security code is complete.

After the change, the status is [UnLoC]. To [LoC], perform key-lock setting again.

## Maintenance and Inspection

### **How to reset the product after a power cut or when the power has been unexpectedly removed**

The settings for the product are retained in memory prior to the power loss or de-energizing of the product. The output condition is also recoverable to that prior to the power loss or de-energizing. However, this may change depending on the operating environment. Therefore, check the safety of the whole installation before operating the product.

# Troubleshooting

## Troubleshooting

Applicable Flow switch: LFE series

If an operation failure of the flow switch occurs, please confirm the cause of failure from the flow chart below. If a cause applicable to the failure cannot be identified and normal operation can be recovered by replacement with a new flow switch, this indicates that the flow switch itself was faulty. The damage to the pressure switch may have been caused by operating environment (network construction, etc.). Consult with SMC separately to obtain countermeasures.

### Troubleshooting list

Fault Status	Problem	Possible cause	Investigation method	Countermeasure
Display failure	No display.	Incorrect wiring	Check that the brown wire is connected to DC (+), blue wire is connected to DC (-).	Check and correct the wiring.
		Loose connector	Check the connection of the connector.	Connect the connector.
	Unstable display	Foreign matter in the sensor fluid passage	Check the presence of foreign matter	Remove foreign matter.
		Water supply shortage	- Confirm whether the fluid path is full.	Fill the fluid path with fluid.
		There are bubbles in the fluid path.	Check there are no air bubbles in the tank.	Change the layout of piping to prevent air bubbles from occurring in the fluid path.
		Pulsation in the flow.	Check if there is supply pressure fluctuation or pressure pulsation due to the characteristics of the compressor or pump acting as the pressure source.	Change to a pump with less pulsation. Install a tank to reduce the pressure fluctuation. Change to elastic piping such as rubber hoses.
		Installed in area not suitable for mounting.	Check the distance between sensors. (See page 16.)	Install sensors outside of the area not suitable for mounting. Execute the close proximity setting mode. (See page 50.)
	Incorrect display	Foreign matter in the sensor fluid passage	Check the presence of foreign matter	Remove foreign matter.
		The piping is connected in the wrong direction.	Check the fluid direction	Correct the fluid piping direction.
		Water supply shortage	- Confirm whether the fluid path is full.	Fill the fluid path with fluid.
		There are bubbles in the fluid path.	Check there is no air bubble in the tank.	Change the layout of piping to prevent air bubbles from occurring.
		Leakage occurs	Check for air leakage due to insufficient tightening of the screw of the piping and/or improper sealing.	Reconnect the pipes with the specified tightening torque and rewrap the sealant tape.

Fault	Problem	Possible cause	Investigation method	Countermeasure
Output signal is abnormal	No output	Incorrect wiring	Check if the brown wire DC (+), blue wire DC (-) and white wire (OUT2) are connected.	Check and correct the wiring.
		Loose connector	Check the connection of the connector.	Connect the connector.
	Unstable output	Foreign matter in the sensor fluid passage	Check the presence of foreign matter	Remove foreign matter.
		Water supply shortage	- Confirm whether the fluid path is full.	Fill the fluid passage with water.
		There are bubbles in the fluid path.	Check there is no air bubble in the tank.	Change the layout of piping to prevent air bubbles from occurring.
		Pulsation in the flow.	Check if there is supply pressure fluctuation or pressure pulsation due to the characteristics of the compressor or pump acting as the pressure source.	Change to a pump with less pulsation. Install a tank to reduce the pressure fluctuation. Change to elastic piping such as rubber hoses.
		Leakage occurs	Check for air leakage due to insufficient tightening of the screw of the piping and/or improper sealing.	Reconnect the pipes with the specified tightening torque and rewrap the sealant tape.
		Noise	Check if there is a power line or a high voltage line which generates noise in the wiring route.	Route wiring separately from power lines and high voltage lines.
	Hysteresis is too small.	Check the hysteresis set value.	Increase the hysteresis.	
	The push buttons do not work	The push buttons do not react.	Key-lock mode is activated.	Check if it displays "Loc" when the buttons are pushed.
Cannot be set	OUT1/OUT2 set value does not go down.	Hysteresis is too large.	Check the hysteresis.	Reduce the hysteresis.  Display and output may become unstable due to flow rate pulsation.

## Error display function

Error Name	Display	Description	Measures
OUT1 over current error	Er1	A load current of 80 mA or more is flowing to the switch output (OUT1).	Turn the power off and remove the cause of the over current. Then turn the power on again.
OUT2 over current error	Er2	A load current of 80 mA or more is flowing to the switch output (OUT2).	
Zero-reset Error	Er3	The detection passage is not filled or the flow rate exceeds +/-20% F.S. of the rated flow rate during zero-reset setting.  Note that the screen will return to the function mode [F34] automatically after 1 second. +/-1% F.S. of the rated flow rate varies due to individual product difference.	Leave the product for sufficient while filling the detection passage with no flow before operation.
Excessive instantaneous flow	HHH	The flow rate is exceeding the flow rate range (the rated flow rate x 1.2).	Reduce the flow.
Reverse flow error	LLL	The flow is flowing in the reverse direction of the setting.	Apply flow in the correct direction.
Excessive accumulated flow	9999999999 (Alternately displays [999] and [999999].)	The accumulated flow range has been exceeded.	Reset the accumulated flow. (This measure is not necessary unless accumulated flow is used)
System error	Er0 Er4 Er6 Er8	Displayed if an internal data error has occurred.	Turn the power off and on again.
Sensor	Er10	Source voltage has exceeded 24 V +/-10%	Check the power supply voltage, and turn the power off and turn it on again.

If the error cannot be reset after the above measures are taken, then please contact SMC



## Specifications

### ■ Specifications

#### Specifications

Model	LFE1	LFE2	LFE3
Applicable Fluids *1	Conductive fluids which do not corrode the fluid contact materials. *1		
Applicable fluid conductivity *1	5 $\mu$ S/cm or more (micro Siemens/cm)		
Detecting method	Electro static capacity		
Ground*10	Negative ground		
Rated flow range	0.5 to 20 L/min	2.5 to 100 L/min	5 to 200 L/min
Display range	0.4~24.0 L/min	2.0 to 120.0 L/min	4 to 240 L/min
Set point range	0.4~24.0 L/min	2.0 to 120.0 L/min	4 to 240 L/min
Zero-cut flow *2	0.4 L/min	2.0 L/min	4 L/min
Min. setting unit	0.1 L/min	0.5 L/min	1 L/min
Accumulated volume per pulse (Pulse width=50ms)	0.1 L/pulse	0.5 L/pulse	1 L/pulse
Fluid temperature *3	0 to 85°C (No condensation or freezing)		
Display unit	Instantaneous flow L/min, accumulated flow L		
Repeatability	Display value: +/-2%F.S.*2 Analogue output: +/-1.5%F.S.		
Temperature characteristics	Ambient temperature characteristics	+/-5%F.S. (0 to 25°C standard)	
	Fluid temperature characteristic	+/-5%F.S. (0 to 25°C standard)	
Operating pressure range*3	0 to 1 MPa		
Withstand pressure *3	2 MPa		
Accumulated flow range*4	99999999.9 L	999999999 L	
	By 0.1L	By 1L	
Switch output	NPN or PNP open collector output		
Switch output	Maximum load Current	80 mA	
	Maximum applied voltage	28 VDC	
	Internal voltage drop	NPN: 1 V max. (at 80 mA load current) PNP: 1.5 V max. (at 80 mA load current)	
	Response time *5*7	0.25 s/0.5 s/1 s/2 s/5 s	
	Output protection	Short circuit protection	
	Output Mode	Select from Hysteresis mode, Window comparator mode, Accumulated output mode or Accumulated pulse output mode	
Analogue output	Response time *6*7	0.25 s/0.5 s/1 s/2 s/5 s	
	Voltage output	Output voltage: 1 to 5V (Output impedance approx. 1k $\Omega$ )	
	Current output	Output current : 4 to 20 mA Max. load impedance 600 $\Omega$	
Hysteresis	Variable		
Display type	2 types of display(7-segment for upper 4 digits) 2-color indication Red / Green, Lower 6 digits 11-segment White) Display updating interval 5 times/sec.		
Operation LED	Output 1 Output 2: Orange		

Model		LFE1	LFE2	LFE3
Power supply voltage		DC24V +/-10%		
Current consumption		45mA or less (Load current is not included)		
Environmental resistance	Enclosure *9	IP65		
	Operating temperature range	0 to 50°C (No condensation or freezing)		
	Operating humidity range	Operation, Storage: 35 to 85%RH (No condensation)		
Standards		CE marking, RoHS		
Material of fluid contact parts		PPS, FKM, C37		
Port size		3/8(10 A)	1/2(15 A)	3/4(20 A) 1(25 A)
Weight(Body) *8		Approx. 340 g	Approx. 400 g	Approx. 520 g Approx. 680 g

\*1: Refer to page 66 [Applicable fluids list].

\*2: 0L/min is displayed when the flow is less than zero-cut flow.

\*3: When fluids with high temperature are used, the available pressure range will be reduced. (See [operating pressure range] on page 69 for details.)

\*4: The accumulated value will be cleared when the power supply is turned off. It is possible to select the function to memorize it. (Select the interval of 2 min. or 5min.)  
When a 5min. interval is selected, the maximum life of the electronic memory element is 1 million writes (if energized for 24 hours, 5min. x 1 million times = 5 million minutes = Approx. 9.5 years). If accumulated value hold is used, calculate the life based on the operating conditions not to exceed the life of the product.

\*5: The response time is when the set value is 63% in relation to the step input.

\*6: The response time is when the set value reaches 63% in relation to the step input. There might be a 0.05 seconds delay at response time of 0.25s or 0.5s due to the timing of internal processing.

\*7: The stability of display and analogue output improves by increasing the response time. (See [Stability] on page 69 for details.)

\*8: When options are used, add the weight of the option parts.

\*9: The enclosure rating includes the digital flow switch with a lead wire with M12 connector.

\*10: Piping port of the body is grounded to DC(-)/blue line. A power supply with positive ground cannot be used.

■ Applicable Fluids

**Applicable fluid list**

Substance description	Judgment	Remarks
Water	O	Conductivity of tap water: 100 to 200 $\mu$ S/cm
Deionized water	X	The electric conductivity is too low.
Water base coolant	O	When the ratio of water is 50% or more.
Oil	X	The electric conductivity is too low.
Oil base coolant	X	The electric conductivity is too low.
Sea water	X	Corrosive to the product.
Ethylene glycol	X	The electric conductivity is too low.
Ethanol	X	The electric conductivity is too low.
Methanol	X	The electric conductivity is too low.
Chloride water (Hypochlorous acid)	X	Corrosive to the product.

\*: The applicable fluid list should be used as a guide.

(1) Operate fluids with electric conductivity of 5 $\mu$ S/cm or more.

Note that this product can not be used for fluids with low conductivity.

This product cannot be used for fluids that do not conduct electricity such as De-ionized water and oil.

The electric conductivity is a ratio which shows how easily the electricity flows.

(2) If insulating material gets stuck inside of the piping, it may cause an error.

Remove the foreign material stuck inside of the piping with a brush for washing test tubes so that internal rubber piping will not be damaged.

(3) If conductive materials such as metal get stuck to the interior surface in the piping, the switch may malfunction.

Remove the foreign material as mentioned above.

(4) If stray electrical currents are flowing through the fluid to be measured, the switch may malfunction.

Beware that electrical leakage currents may be generated by equipment around the flow sensor such as pumps, valves and metal piping when this equipment is at different electrical potentials in relation to earth ground.

(5) Any fluid which corrodes the internal fluid contact parts cannot be used.

**Cable with M12 connector lead wire (LFE-1-A3)**

Item		Specifications
Conductor	Nominal cross section	AWG21
	O.D.	Approx. 0.9 mm
Insulator	Material	Lead free heat resistant PVC
	O.D.	Approx. 1.7 mm
	Colours	Brown, White, Black, Blue
Sheath	Material	Lead free heat and oil resistant PVC
Finished O.D.		$\phi$ 6

■ Characteristics Chart

**Flow characteristics (pressure loss)**

LFE1

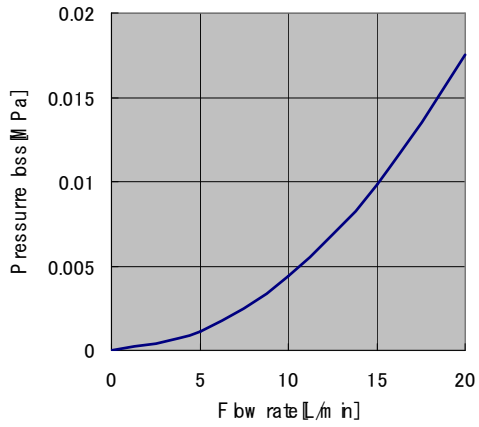

LFE2

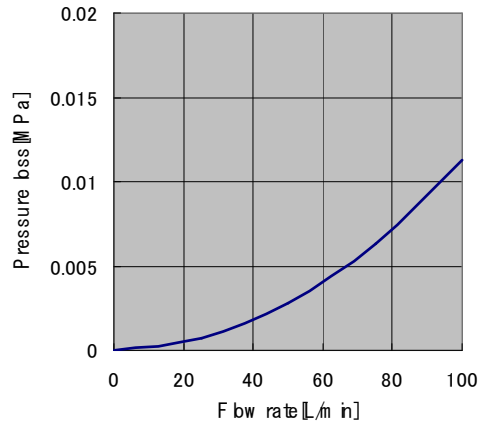

LFE3

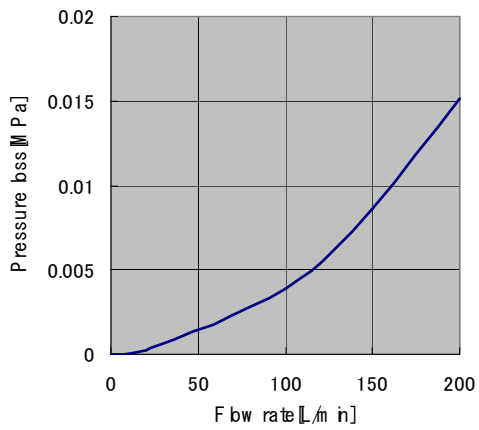

### IN side straight pipe length (reference value)

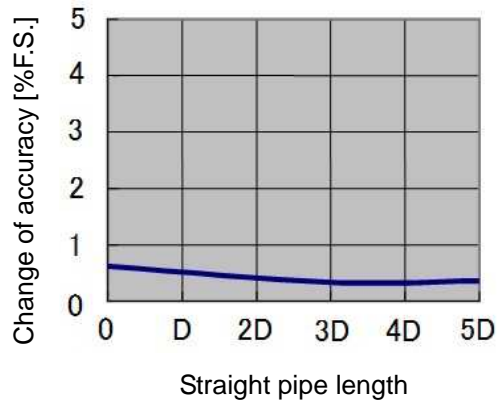
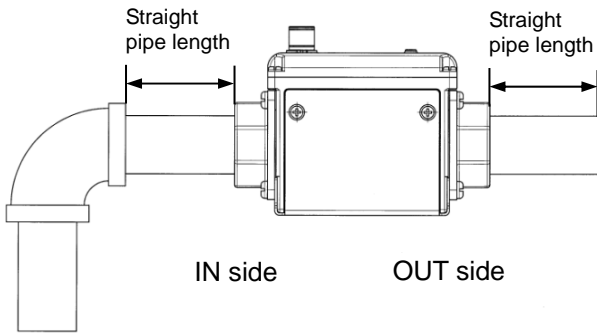

[Measurement condition]	[Port size]
Measurement: Tap water	LFE1 : 3/8 inch
Pressure: 0.2 MPa	LFE2 : 3/4 inch
	LFE3 : 1 inch

The smaller the piping size, the more the product is affected by the straight piping length. The straight piping length shall be 5 times (5D) or more of the piping size to satisfy and achieve the stable measurement.

Model	Straight pipe length (mm)	
	D	5 D
LFE1	11	55
LFE2	21	105
LFE3	27	135

### ■ Stability

Fluctuation of the display and the analogue output can be reduced by lengthening the response time setting.

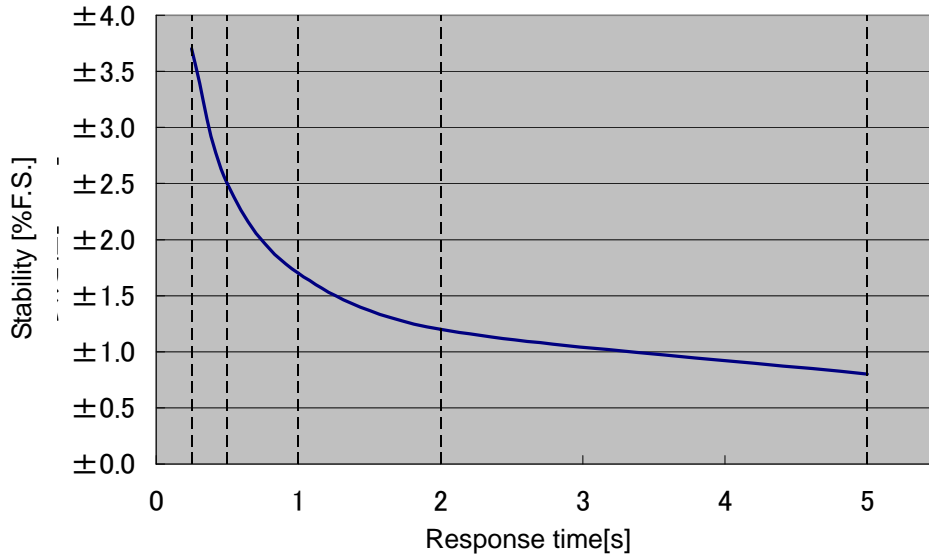

### ■ Operating pressure range

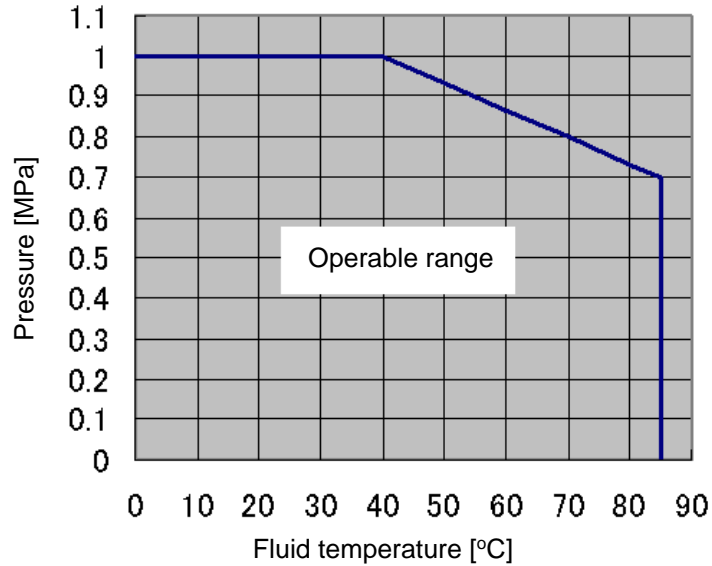

When fluids with high temperature are used, the operating pressure range will be reduced. Operate within the range mentioned above.

The proof pressure is double the operating pressure range.

■ Analogue output

**Flow/Analogue output**

	A	B	C
Voltage output	1 V	1.1 V	5 V
Current output	4 mA	4.4 mA	20 mA

Model	Rated flow[L/min]	
	Minimum	Maximum
LFE1	0.5	20
LFE2	2.5	100
LFE3	5	200

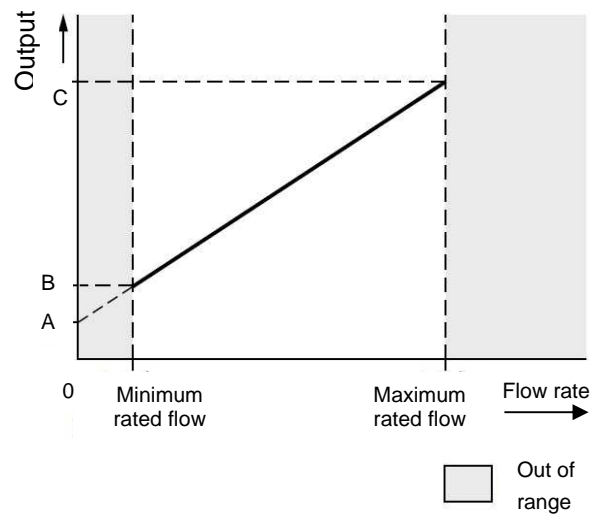

■ Dimensions

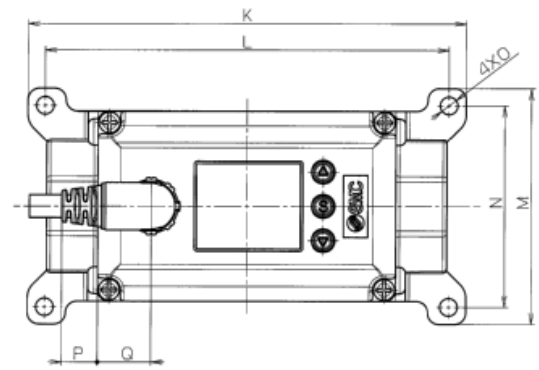
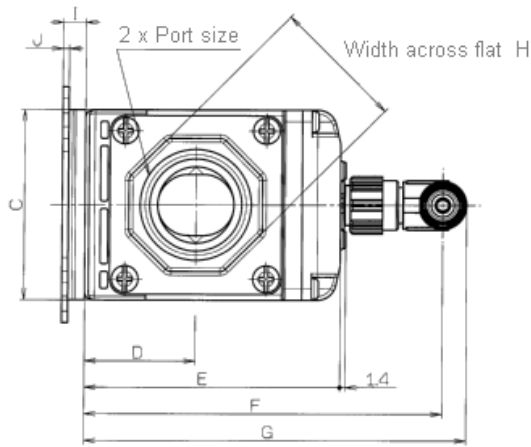

Note) The electrical entry for lead wire with M12 connector does not rotate and is limited to only one entry direction.

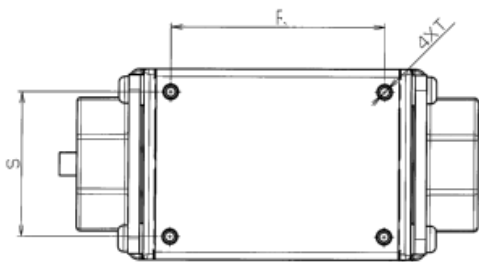

Without bracket ( Bottom view )

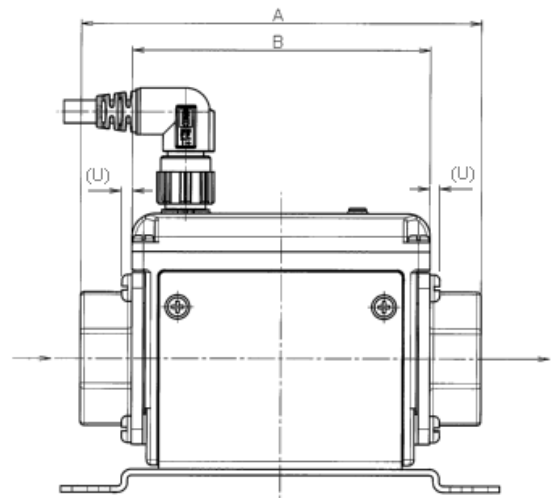

Bracket thickness is approx. 1.6mm

Model	Piping port size	A	B	C	D	E	F	G	H	I	J	K	L
LFE1□3□□	3/8	90	73	40	23.5	56	83	89	24	6	1.6	96	87
LFE1□4□□	1/2	104	73	40	23.5	56	83	89	28	6	1.6	96	87
LFE2□6□□	3/4	105	78	50	29	67	94	100	35	6	1.6	115	106
LFE3□8□□	1	120	90	55	32	73	100	106	41	6	1.6	115	106

Model	M	N	O	P	Q	R	S	T	U	Bracket weight
LFE1□3□□	48	39	4.6	12	11.5	52	28	2.5 depth 8.5	2	Approx. 45g
LFE1□4□□	48	39	4.6	12	11.5	52	28	2.5 depth 8.5	2	Approx. 45g
LFE2□6□□	62	53	4.6	9.5	14	56	38	2.5 depth 8.5	2.6	Approx. 70g
LFE3□8□□	62	53	4.6	3.5	20	68	43	2.5 depth 8.5	2.6	Approx. 70g



Dimension of the cable with M12 connector lead wire (LFE-1-A3)

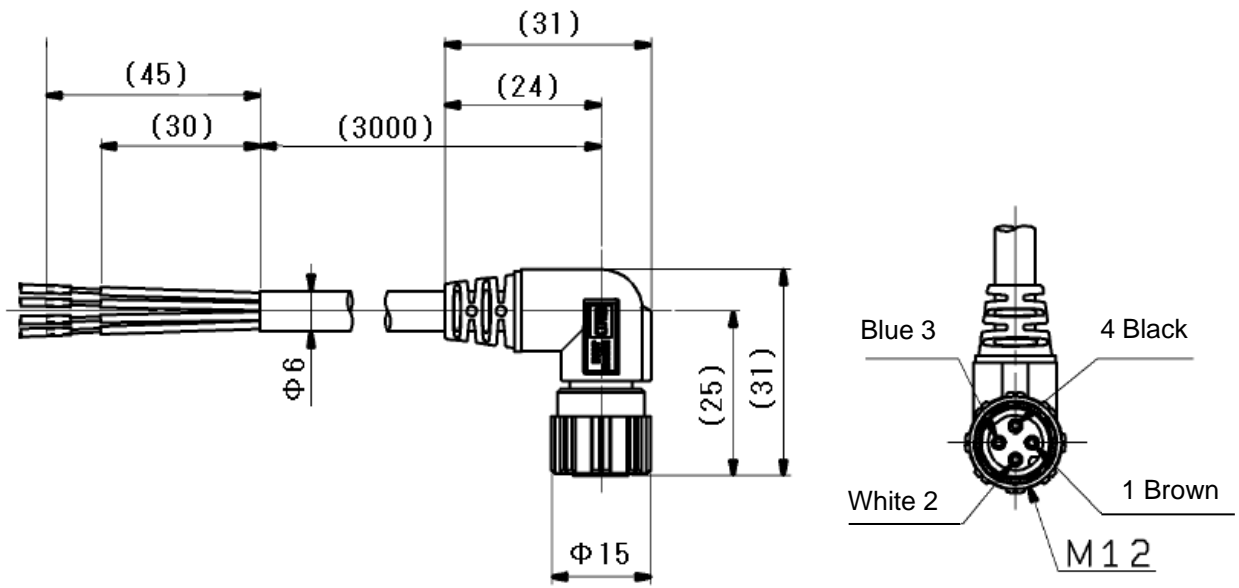

Revision
A : Contents revised in several places.
B : Contents revised in several places.
C : Contents revised in several places.
D : Contents are added.
E : Contents revised in several places.
F : Contents revised in several places.
G : Contents revised in several places.

## SMC Corporation

4-14-1, Sotokanda, Chiyoda-ku, Tokyo 101-0021 JAPAN

Tel: + 81 3 5207 8249 Fax: +81 3 5298 5362

URL <https://www.smcworld.com>

---

Note: Specifications are subject to change without prior notice and any obligation on the part of the manufacturer.  
© 2020 SMC Corporation All Rights Reserved

No.LV50\*\*\*-OMQ0002-G