

Flow Sensor Operation Manual



PF2D5□□

Thank you for purchasing an SMC PF2D5□□ Series Flow Sensor. Please read this manual carefully before operating the product and make sure you understand its capabilities and limitations. Please keep this manual handy for future reference.

To obtain more detailed information about operating this product, please refer to the SMC website (URL <http://www.smcworld.com>) or contact SMC directly.

Safety Instructions

These safety instructions are intended to prevent hazardous situations and/or equipment damage. These instructions indicate the level of potential hazard with the labels of "Caution", "Warning" or "Danger". They are all important notes for safety and must be followed in addition to International standards (ISO/IEC) and other safety regulations.

- Caution:** CAUTION indicates a hazard with a low level of risk which, if not avoided, could result in minor or moderate injury.
- Warning:** WARNING indicates a hazard with a medium level of risk which, if not avoided, could result in death or serious injury.
- Danger:** DANGER indicates a hazard with a high level of risk which, if not avoided, will result in death or serious injury.

Operator

- ◆ This operation manual is intended for those who have knowledge of machinery using pneumatic equipment, and have sufficient knowledge of assembly, operation and maintenance of such equipment. Only those persons are allowed to perform assembly, operation and maintenance.
- ◆ Read and understand this operation manual carefully before assembling, operating or providing maintenance to the product.

Safety Instructions

Warning

- Do not disassemble, modify (including changing the printed circuit board) or repair. An injury or failure can result.
- Do not operate the product outside of the specifications. Do not use for flammable or harmful fluids. Fire, malfunction, or damage to the product can result. Verify the specifications before use.
- Do not operate in an atmosphere containing flammable, explosive or corrosive gas. Fire, explosion or corrosion can result. This product is not designed to be explosion proof.
- Do not use the product for flammable or highly permeable fluids. Fire, explosion, corrosion or damage can result. Refer to the Material Safety Data Sheet and confirm safety before use.
- Do not use the product in a place where static electricity is a problem. Otherwise it can cause failure or malfunction of the system.
- If using the product in an interlocking circuit:
 - Provide a double interlocking system, for example a mechanical system
 - Check the product regularly for proper operation
 Otherwise malfunction can result, causing an accident.

- The following instructions must be followed during maintenance:
 - Turn off the power supply
 - Ensure the flow is shut off before performing maintenance
 Otherwise an injury can result.

Caution

- Do not touch the terminals and connectors while the power is on. Otherwise electric shock, malfunction or damage to the product can result.
- Do not touch the piping or its connected parts when the fluid is at high temperature. It may lead to burnt. Ensure the piping cools sufficiently before touching.
- After maintenance is complete, perform appropriate functional inspections and leak tests. Stop operation if the equipment does not function properly or there is a leakage of fluid. When leakage occurred from parts other than the piping, the product might be faulty. Disconnect the power supply and stop supplying fluid. Do not apply fluid under leaking conditions. Safety cannot be assured in the case of unexpected malfunction.

Summary of Product parts

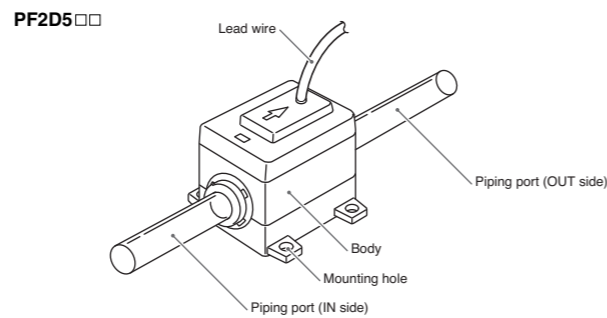

Item	Description
Body	The body of the product.
Piping port (Tube)	Connected to the fluid inlet at IN side and to the fluid outlet at OUT side.
Mounting hole	Used to mount the product.
Lead wire	Lead wire to supply power and transmit output signals. (3 m)

Piping

- Use the product within the specified operating pressure range and temperature range.
- Proof pressure is 1.5 MPa for PF2D504/520 and 0.9 MPa for PF2D540. Proof pressure could vary according to the fluid temperature. Check the characteristics data for operating pressure and proof pressure.
- Connect the piping using suitable fittings.
- Mount the product so that the fluid direction is the same as the arrow indicated on the product.
- The piping on the IN side must have a straight section of piping whose length is 8 times the piping diameter or more.
- Avoid sudden changes in the piping size on the IN side of the product.

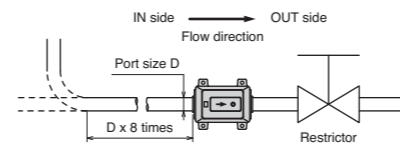

- Bubbles may be generated depending on the piping design. Refer to an example of recommended piping system.

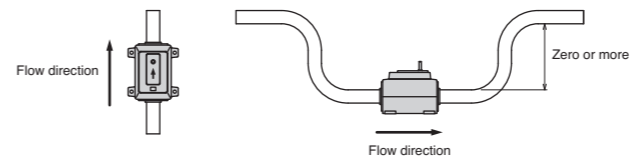

Connecting the piping

- LQ1 fitting is recommended for connecting of the piping.
- Refer to the literatures of fitting for piping method.

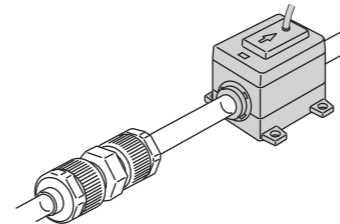

Wiring

- Connections should only be made with the power supply turned off.
- Use separate routes for the product wiring and any power or high voltage wiring. Otherwise, malfunction may result due to noise.
- Ensure that the FG terminal is connected to ground when using a commercially available switch-mode power supply. When a switch-mode power supply is connected to the product, switching noise will be superimposed and the product specification can no longer be met. This can be prevented by inserting a noise filter, such as a line noise filter and ferrite core, between the switch-mode power supply and the product, or by using a series power supply instead of a switch-mode power supply.

Lead wire

Colour	Content
Black	Output for PF2D3□□
Brown	DC(+)
Blue	DC(-)
White	Analogue output

Connecting the wiring

Attaching the sensor connector to the lead wire (When the product connects to the PF2D2□□)
Refer to the PF2D2□□ operation manual for details of the sensor connector pin numbers.

- Strip the lead wire as shown. Do not cut the insulator.

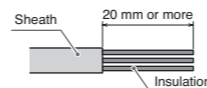

- Insert the corresponding wire colour into the pin number printed on the sensor connector, to the bottom, then part A shown should be pressed in by hand to make temporary connection.

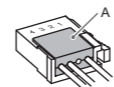

- Part A should then be pressed in using a suitable tool, such as pliers.



*: The connector cannot be re-used once it has been fully crimped. In cases of connection failure such as incorrect order of wires or incomplete insertion, please use the new connector.

Internal circuit and wiring example

Output for PF2D3□□ + Analogue (1 to 5 V) type: PF2D5□□-□□-1

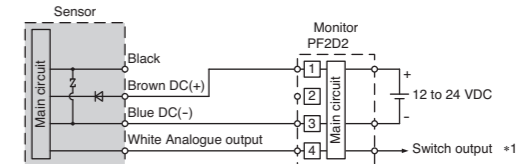
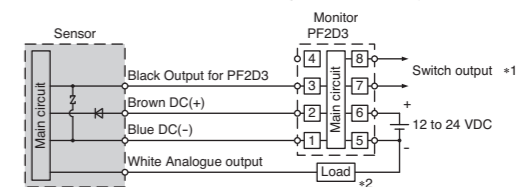

Analogue output: 1 to 5 V
Output impedance: 1 kΩ
(load impedance: 100 kΩ or more)

- *1: Refer to the PF2D3□□ or PF2D2□□ operation manual for details of the flow monitors.
- *2: Load indicates analogue input equipment such as a voltmeter.

Output for PF2D3□□ + Analogue (4 to 20 mA) type: PF2D5□□-□□-2

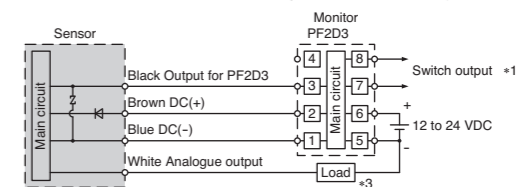

Analogue output: 4 to 20 mA
Max. load impedance: 300 Ω (12 VDC)
600 Ω (24 VDC)

- *1: Refer to the PF2D3□□ operation manual for details of the flow monitor.
- *3: Load indicates analogue input equipment such as an ammeter.

Troubleshooting

Refer to the SMC website (URL <http://www.smcworld.com>) for more information about troubleshooting.

Specifications / Outline with Dimensions

Material of parts in contact with fluid and fluids compatibility checklist

Fluid	Condition	Compatibility
Acetone	concentration 100% or less	○
Ammonium hydroxide	concentration 30% or less	○
Isobutyl alcohol	-	x
Isopropyl alcohol	-	○
Hydrochloric acid	concentration 38% or less	○
Ozone	-	x
Hydrogen peroxide	concentration 50% or less, 50 °C or less	○
Ethyl acetate	-	○
Butyl acetate	-	○
Nitric acid	concentration 10% or less	○
Pure water	-	○
Sodium hydroxide	-	x
Super pure water	-	○
Toluene	-	○
Hydrofluoric acid	concentration 50% or less	○
Sulfuric acid	concentration 20% or less	○
Phosphoric acid	concentration 30% or less	○

Table symbol ○: Can be used, Can be used under certain condition x: Cannot be used

- *1: The material and fluid compatibility check list provides reference value as a guide only.
- *2: It is possible that some fluids are permeable on the type of fluid, its density and temperature. Any permeated fluid may affect the products life. Thus, when using these fluids type verify the fluid in advance by testing it, prior to making a decision to use it.

Refer to the product catalogue or SMC website (URL <http://www.smcworld.com>) for more information about the product specifications and outline dimensions.

SMC Corporation URL <http://www.smcworld.com>

Akihabara UDX 15F, 4-14-1, Sotokanda, Chiyoda-ku, Tokyo 101-0021, JAPAN
Phone: +81 3-5207-8249 Fax: +81 3-5298-5362

Note: Specifications are subject to change without prior notice and any obligation on the part of the manufacturer.
© 2011 SMC Corporation All Rights Reserved