



Operation Manual

PRODUCT NAME

Digital Flow Switch
(Remote type monitor unit)

MODEL / Series / Product Number

PF2A3##
PF2W3##
PF2D3##

SMC Corporation

Table of Contents

Safety Instructions	2
Model Indication and How to Order	9
Summary of Product parts	11
Definition and terminology	12
Mounting and Installation	14
Installation	14
Wiring	16
Outline of setting	18
List of outputs	19
Initialize mode	20
Default settings	20
Setting procedure of Initialize mode	21
Function selection mode	26
Default settings	26
F_1 Input procedure of the Set value of instantaneous output	27
F_2 Input procedure of the Set value of instantaneous output (Auto-preset)	28
F_3 Input procedure of the Set value of accumulated output	29
Key-lock function	31
Maintenance	32
Troubleshooting	33
Cross-reference for troubleshooting	33
Error indication	35
Specifications	36
Specifications	36
Dimensions	40



Safety Instructions

These safety instructions are intended to prevent hazardous situations and/or equipment damage. These instructions indicate the level of potential hazard with the labels of "Caution", "Warning" or "Danger".

They are all important notes for safety and must be followed in addition to International Standards (ISO/IEC)*1), and other safety regulations.

*1) ISO 4414: Pneumatic fluid power -- General rules relating to systems.

ISO 4413: Hydraulic fluid power -- General rules relating to systems.

IEC 60204-1: Safety of machinery -- Electrical equipment of machines. (Part 1: General requirements)

ISO 10218: Manipulating industrial robots -Safety.

etc.



Caution

Caution indicates a hazard with a low level of risk which, if not avoided, could result in minor or moderate injury.



Warning

Warning indicates a hazard with a medium level of risk which, if not avoided, could result in death or serious injury.



Danger

Danger indicates a hazard with a high level of risk which, if not avoided, will result in death or serious injury.

Warning

1. The compatibility of the product is the responsibility of the person who designs the equipment or decides its specifications.

Since the product specified here is used under various operating conditions, its compatibility with specific equipment must be decided by the person who designs the equipment or decides its specifications based on necessary analysis and test results.

The expected performance and safety assurance of the equipment will be the responsibility of the person who has determined its compatibility with the product.

This person should also continuously review all specifications of the product referring to its latest catalog information, with a view to giving due consideration to any possibility of equipment failure when configuring the equipment.

2. Only personnel with appropriate training should operate machinery and equipment.

The product specified here may become unsafe if handled incorrectly.

The assembly, operation and maintenance of machines or equipment including our products must be performed by an operator who is appropriately trained and experienced.

3. Do not service or attempt to remove product and machinery/equipment until safety is confirmed.

1. The inspection and maintenance of machinery/equipment should only be performed after measures to prevent falling or runaway of the driven objects have been confirmed.

2. When the product is to be removed, confirm that the safety measures as mentioned above are implemented and the power from any appropriate source is cut, and read and understand the specific product precautions of all relevant products carefully.

3. Before machinery/equipment is restarted, take measures to prevent unexpected operation and malfunction.

4. Contact SMC beforehand and take special consideration of safety measures if the product is to be used in any of the following conditions.

1. Conditions and environments outside of the given specifications, or use outdoors or in a place exposed to direct sunlight.

2. Installation on equipment in conjunction with atomic energy, railways, air navigation, space, shipping, vehicles, military, medical treatment, combustion and recreation, or equipment in contact with food and beverages, emergency stop circuits, clutch and brake circuits in press applications, safety equipment or other applications unsuitable for the standard specifications described in the product catalog.

3. An application which could have negative effects on people, property, or animals requiring special safety analysis.

4. Use in an interlock circuit, which requires the provision of double interlock for possible failure by using a mechanical protective function, and periodical checks to confirm proper operation.



Safety Instructions

Caution

1. The product is provided for use in manufacturing industries.

The product herein described is basically provided for peaceful use in manufacturing industries. If considering using the product in other industries, consult SMC beforehand and exchange specifications or a contract if necessary.
If anything is unclear, contact your nearest sales branch.

Limited warranty and Disclaimer/Compliance Requirements

The product used is subject to the following "Limited warranty and Disclaimer" and "Compliance Requirements".

Read and accept them before using the product.

Limited warranty and Disclaimer

1. The warranty period of the product is 1 year in service or 1.5 years after the product is delivered, whichever is first.*2)

Also, the product may have specified durability, running distance or replacement parts. Please consult your nearest sales branch.

2. For any failure or damage reported within the warranty period which is clearly our responsibility, a replacement product or necessary parts will be provided.

This limited warranty applies only to our product independently, and not to any other damage incurred due to the failure of the product.

3. Prior to using SMC products, please read and understand the warranty terms and disclaimers noted in the specified catalog for the particular products.

***2) Vacuum pads are excluded from this 1 year warranty.**

A vacuum pad is a consumable part, so it is warranted for a year after it is delivered. Also, even within the warranty period, the wear of a product due to the use of the vacuum pad or failure due to the deterioration of rubber material are not covered by the limited warranty.

Compliance Requirements

1. The use of SMC products with production equipment for the manufacture of weapons of mass destruction (WMD) or any other weapon is strictly prohibited.

2. The exports of SMC products or technology from one country to another are governed by the relevant security laws and regulation of the countries involved in the transaction. Prior to the shipment of a SMC product to another country, assure that all local rules governing that export are known and followed.

Caution

SMC products are not intended for use as instruments for legal metrology.

Products that SMC manufactures or sells are not measurement instruments that are qualified by pattern approval tests relating to the measurement laws of each country. Therefore, SMC products cannot be used for business or certification ordained by the measurement laws of each country.

Operator

- ◆ This operation manual is intended for those who have knowledge of machinery using pneumatic equipment, and have sufficient knowledge of assembly, operation and maintenance of such equipment. Only those persons are allowed to perform assembly, operation and maintenance.
- ◆ Read and understand this operation manual carefully before assembling, operating or providing maintenance to the product.

■ Safety Instructions

Warning

- Do not disassemble, modify (including changing the printed circuit board) or repair.
An injury or failure can result.
- Do not operate the product outside of the specifications.
Do not use for flammable or harmful fluids.
Fire, malfunction, or damage to the product can result.
Verify the specifications before use.
- Do not operate in an atmosphere containing flammable, explosive or corrosive gas.
Fire, explosion or corrosion can result.
This product is not designed to be explosion proof.
- Do not use the product in a place where static electricity is a problem.
Otherwise it can cause failure or malfunction of the system.
- If using the product in an interlocking circuit:
 - Provide a double interlocking system, for example a mechanical system
 - Check the product regularly for proper operationOtherwise malfunction can result, causing an accident.
- The following instructions must be followed during maintenance:
 - Turn off the power supply
 - Ensure the flow is shut off before performing maintenanceOtherwise an injury can result.

Caution

- Do not touch the terminals and connectors while the power is on.
Otherwise electric shock, malfunction or damage to the product can result.
- Do not touch the piping or its connected parts when the fluid is at high temperature.
It may lead to burnt.
Ensure the piping cools sufficiently before touching.
- After maintenance is complete, perform appropriate functional inspections and leak tests.
Stop operation if the equipment does not function properly or there is a leakage of fluid.
When leakage occurs from parts other than the piping, the product might be faulty.
Disconnect the power supply and stop the fluid supply.
Do not apply fluid under leaking conditions.
Safety cannot be assured in the case of unexpected malfunction.

■ NOTE

- Follow the instructions given below when designing, selecting and handling the product.
 - The instructions on design and selection (installation, wiring, environment, adjustment, operation, maintenance, etc.) described below must also be followed.
 - *Product specifications
 - Use the specified voltage.
Otherwise failure or malfunction can result.
Insufficient supply voltage may not drive a load due to a voltage drop inside the product.
Verify the operating voltage of the load before use.
 - Do not exceed the specified maximum allowable load.
Otherwise it can cause damage or shorten the lifetime of the product.
 - Data stored by the product is not deleted, even if the power supply is cut off.
(writing time: 1000000 cycles)
 - Reserve a space for maintenance.
Allow sufficient space for maintenance when designing the system.

● Product handling

*Installation

- Do not apply excessive stress to the product when it is panel mounted.
Otherwise damage to the product and disconnection from the panel mount can result.
- Ensure that the FG terminal is connected to ground when using a commercially available switch-mode power supply.
- Do not drop, hit or apply excessive shock to the product.
Otherwise damage to the internal parts can result, causing malfunction.
- Do not pull the lead wire forcefully, not lift the product by pulling the lead wire. (Tensile force 49 N or less)
Hold the product body when handling, to prevent damage, failure or malfunction.
- The tensile strength of the power supply/output connection cable is 50 N and the sensor lead wire with a connector is 25 N.
- Never mount the product in a location that will be used as a foothold.
The product may be damaged if excessive force is applied by stepping or climbing onto it.

*Wiring

- Do not pull the lead wires.
In particular, never lift a product equipped with fitting and piping by holding the lead wires.
Otherwise damage to the internal parts can result, causing malfunction or disconnection of the connector.
- Avoid repeatedly bending or stretching the lead wire, or placing heavy loads on it.
Repeated bending stress or tensile stress can cause damage to the sheath, or breakage of the wires.
If the lead wire can move, fix it near the body of the product.
The recommended bend radius of the lead wire is 6 times the outside diameter of the sheath, or 33 times the outside diameter of the wire insulation material, whichever is larger.
Replace any the damaged lead wire with a new one.
- Wire correctly.
Incorrect wiring can damage the product.
- Do not perform wiring while the power is on.
Otherwise damage to the internal parts can result, causing malfunction.
- Do not route wires and cables together with power or high voltage cables.
Otherwise the product can malfunction due to interference of noise and surge voltage from power and high voltage cables.
- Confirm proper insulation of wiring.
Poor insulation (interference from another circuit, poor insulation between terminals, etc.) can lead to excess voltage or current being applied to the product, causing damage.
- Keep wiring as short as possible to prevent interference from electromagnetic noise and surge voltage.
Do not use a cable longer than 30 m.
Wire the DC(-) line (blue) as close as possible to the power supply.
- When analogue output is used, install a noise filter (line noise filter, ferrite element, etc.) between the switch-mode power supply and this product.

*Environment

- Do not use the product in area that is exposed to corrosive gases, chemicals, sea water, water or steam.
Otherwise failure or malfunction can result.
- Do not use in a place where the product could be splashed by oil or chemicals.
If the product is to be used in an environment containing oils or chemicals such as coolant or cleaning solvent, even for a short time, it may be adversely affected (damage, malfunction, or hardening of the lead wires).
- Do not use in an area where electrical surges are generated.
If there is equipment which generates large electrical surges (solenoid type lifter, high frequency induction furnace, motor, etc.) close to the product, damage or failure of the internal circuit may occur. Take measures against the surge sources, and prevent the wires from coming into close contact.
- Do not use a load which generates surge voltage.
When a surge-generating load such as a relay or solenoid is driven directly, use a product with a built-in surge absorbing element.
- The product is CE marked, but not immune to lightning strikes. Take measures against lightning strikes in the system.
- Do not use the product in areas that are exposed to vibration or impact.
Otherwise failure or malfunction can result.
- Do not use the product in the presence of a magnetic field.
This may lead to the malfunction of the product.
- Prevent foreign matter such as wire debris from entering the product.
Otherwise failure or malfunction can result.
- Do not use the product in areas subject to large temperature cycle.
Heating/cooling cycles other than ordinary changes in temperature can adversely affect the internal structure of the product.
- Do not expose the product to direct sunlight.
If using in a location directly exposed to sunlight, use a suitable protective cover.
Otherwise failure or malfunction can result.
- Keep within the operating temperatures range.
Operating temperature range is 0 to 50 °C.
Operation below the minimum temperature limit may cause damage or operation failure due to frozen moisture in the fluid or air.
Avoid sudden temperature change even within the specified temperature range.
- Do not operate close to a heat source, or in a location exposed to radiant heat.
Otherwise malfunction can result.

*Adjustment and Operation

- Connect load before turning on the power.

- Do not short-circuit the load.

Although an error is displayed when the product load is short circuited, excess current may cause the damage to the product.

- Do not press the setting buttons with a sharp pointed object.

It may damage the setting buttons.

- Supply the power when there is no flow.

- Check regulators and flow adjustment valves before introducing the fluid.

If pressure or flow rate beyond the specified range are applied to the sensor, the sensor unit may be damaged.

- Do not attempt to insert or pull the flow rate sensor or its connector when the power is on.

- The output is off for 3 seconds after power is supplied.

- Perform settings suitable for the operating conditions.

Incorrect settings can cause operational failure.

(Refer to page 18 "Outline of setting")

- During the initial setting and any subsequent flow rate setting, the product will switch the output according to the existing settings until the changes are complete.

Confirm the output has no adverse effect on machinery and equipment before setting.

Stop the control system before setting if necessary.

- Do not touch the LED during operation.

The display can vary due to static electricity.

*Maintenance

- Perform regular maintenance and inspections.

There is a risk of unexpected malfunction of components due to the malfunction of equipment and machinery.

- Turn off the power supply, stop the fluid and check the safety before performing any maintenance.

There is a risk of unexpected malfunction.

- Do not use solvents such as benzene, thinner etc. to clean the product.

They could damage the surface of the body and erase the markings on the body.

Use a soft cloth to remove stains.

For heavy stains, use a cloth lightly dampened with diluted neutral detergent, then wipe up any residue with a dry cloth.

Model indication and How to Order

PF2A3 □ □ -A- □

For air
Remote type monitor

Rated flow range (Applicable sensor)

Symbol	Content
0	1 to 10 L/min (PF2A510)
	5 to 50 L/min (PF2A550)
1	10 to 100 L/min (PF2A511)
	20 to 200 L/min (PF2A521)
	50 to 500 L/min (PF2A551)

Output specification

Symbol	Content
0	NPN (2 outputs)
1	PNP (2 outputs)

Unit specification

Symbol	Content
Nil	Unit selection function *1
M	SI unit only *2

*1: Since the unit for Japan is fixed to SI due to new measurement law, this option is for overseas.
*2: Fixed unit Instantaneous flow: L/min
Accumulated flow: L

Mounting

Symbol	Content
A	Panel mounting

PF2W3 □ □ -A- □

For water
Remote type monitor

Rated flow range (Applicable sensor)

Symbol	Content
0	0.5 to 4 L/min (PF2W504)
	2 to 16 L/min (PF2W520)
	5 to 40 L/min (PF2W540)
3	10 to 100 L/min (PF2W511)

Output specification

Symbol	Content
0	NPN (2 outputs)
1	PNP (2 outputs)

Unit specification

Symbol	Content
Nil	Unit selection function *1
M	SI unit only *2

*1: Since the unit for Japan is fixed to SI due to new measurement law, this option is for overseas.
*2: Fixed unit Instantaneous flow: L/min
Accumulated flow: L

Mounting

Symbol	Content
A	Panel mounting

PF2D3 □ □ -A- □

For deionized water and chemicals
Remote type monitor

Rated flow range (Applicable sensor)

Symbol	Content
0	0.4 to 4 L/min (PF2D504)
	1.8 to 20 L/min (PF2D520)
	4 to 40 L/min (PF2D540)

Output specification

Symbol	Content
0	NPN (2 outputs)
1	PNP (2 outputs)

Unit specification

Symbol	Content
Nil	Unit selection function *1
M	SI unit only *2

*1: Since the unit for Japan is fixed to SI due to new measurement law, this option is for overseas.
*2: Fixed unit Instantaneous flow: L/min
Accumulated flow: L

Mounting

Symbol	Content
A	Panel mounting

Accessories/Part number

If an accessory is required separately, order using the following part numbers.

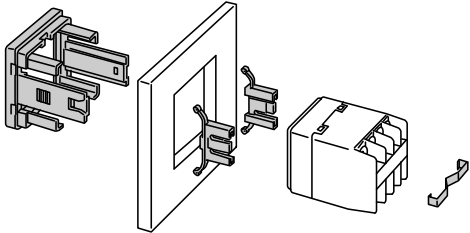
Part number	Description	Remarks	Weight
ZS-22-E	Panel mount adapter		15 g

Summary of Product parts

Front

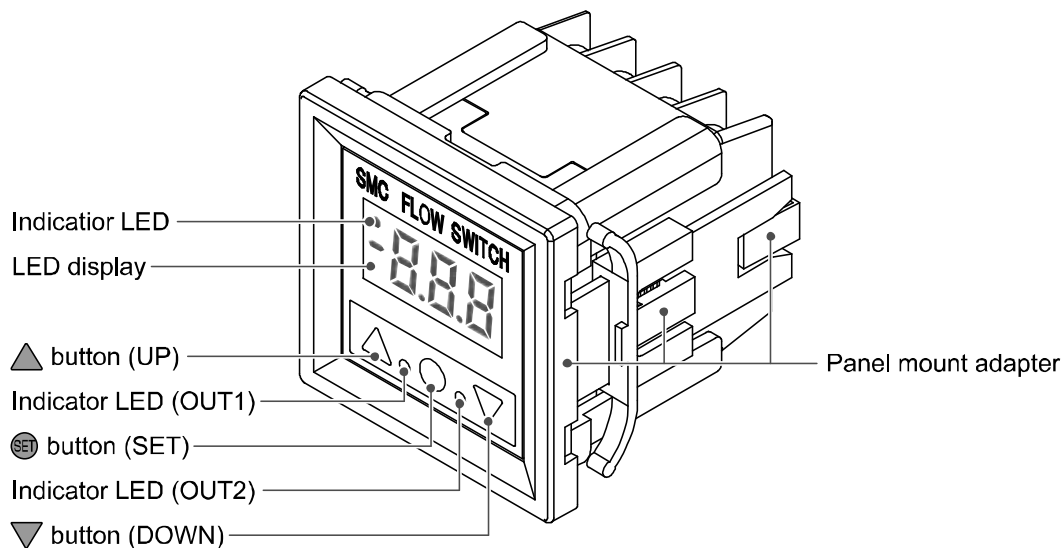

Item	Description
Indicator LED	Indicates the reference condition selected. LED is ON (Red) when normal condition is selected. (Only the PF2A3□□)
LED display	Displays the flow value, setting mode, and error indication.
Indicator LED (OUT1)	Indicates the output status of OUT1. LED is ON (Green) when OUT1 is ON. The LED flashes when an over current error occurs. When the accumulated pulse output mode is selected, the indicator LED will turn OFF.
Indicator LED (OUT2)	Indicates the output status of OUT2. LED is ON (Red) when OUT2 is ON. The LED flashes when an over current error occurs. When the accumulated pulse output mode is selected, the indicator LED will turn OFF.
▲ button (UP)	Selects the mode or increases the ON/OFF Set value.
● button (SET)	Press this button to change to another mode and to set a value.
▼ button (DOWN)	Selects the mode or decreases the ON/OFF Set value.
Panel mount adapter	Adapter to mount the product to the panel.

Back

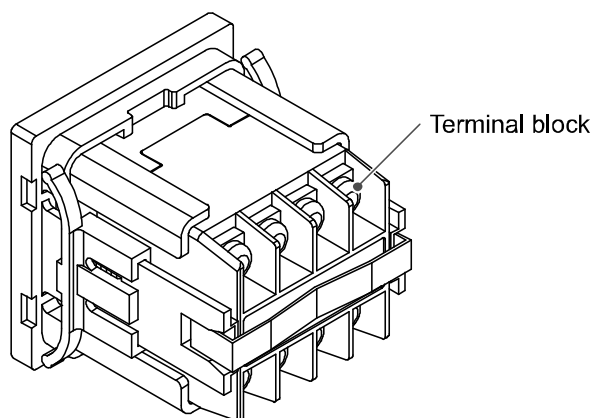

Item	Description
Terminal block	Terminals to connect the power, output and sensor wires. For details, refer to Wiring (page 16).

■ Definition and terminology

	Terms	Meaning
A	Accumulated flow	The total amount of fluid that has passed through the device. If an instantaneous flow of 10 L/min continues for 5 minutes, the accumulated flow will be $10 \times 5 = 50$ L.
	Accumulated pulse output	A type of output where a pulse is generated every time a predefined accumulated flow passes. It is possible to calculate the total accumulated flow by counting the pulses.
	Analogue output	Outputs a value proportional to the flow rate. When the analogue output is in the range 1 to 5 V, it will vary between 1 to 5 V according to the rate of flow. The same for analogue output of 4 to 20 mA.
	Auto-preset	This function calculates and sets an approximate Set value automatically based on the on-going operation.
C	Chattering	The problem of the switch output turning ON and OFF repeatedly around the Set value at high frequency due to the effect of pulsation.
D	Digit	Minimum unit for setting/display is 1 digit. When the minimum unit for setting/display is 5 L/min, 3 digits will be $3 \times 5 = 15$ L/min.
	Display flow range	The range that which can be displayed by the product with a digital display.
F	F.S. (Full span, Full scale)	Stands for "full span" or "full scale", and indicates varied analogue output range at rated value. For example, when analogue output is 1 to 5 V, F.S. = $5[V] - 1[V] = 4[V]$, (ref. $1\%F.S. = 4[V] \times 1\% = 0.04[V]$)
H	Hysteresis	The difference between ON and OFF points used to prevent chattering. Hysteresis can be effective in avoiding the effects of pulsation.
	Hysteresis mode	Mode where the switch output will turn ON when the flow is greater than the Set value, and will turn OFF when the flow falls below the Set value – hysteresis value.
I	Instantaneous flow	The flow passing per unit of time. If it is 10 L/min, there is a flow of 10 L passing through the device in 1 minute.
	Internal voltage drop	The voltage drop across the product (and therefore not applied to the load), when the switch output is ON. The voltage drop will vary with load current, and ideally should be 0 V.
M	Minimum setting/display unit	The resolution of set and display values. If the minimum setting unit is 1 L/min, the display will change in 1 L/min steps, e.g. 10.....11.....12 L/min.
O	Operating humidity range	The ambient humidity range within which the product will meet all published specifications.
	Operating temperature range	The ambient temperature range within which the product will meet all published specifications.
R	Rated flow range	The flow range within which the product will meet all published specifications.
	Rated pressure range	The pressure range within which the product will meet all published specifications.
	Repeatability	Reproducibility of the display or analogue output value, when the measured quantity is repeatedly increased and decreased.
	Response time	Time from when the target flow is applied until the flow reaches 90% of the Set value.

	Terms	Meaning
S	Setting flow range	The range of ON/OFF threshold values that can be set for those products with a switch output.
	Switch output	Output type that has only 2 conditions, ON or OFF. In the ON condition, an indicator LED (output) will show, and any connected load will be powered. In the OFF condition, there will be no indicator LED (output) and no power is supplied to the load.
T	Temperature characteristics	The amount of variation in the analogue output or display value when ambient temperature is changed.
U	Unit selection function	A function to select display units other than the international unit (SI unit) specified in the new Japanese measurement law. Flow can only be displayed by SI units in Japan.
W	Window comparator mode	An operating mode in which the switch output is turned on and off depending on whether the flow is inside or outside the range of two Set values.

Mounting and Installation

■ Installation

- Never mount the product in a location that will be used as a foothold.

● Installing

Removing the panel mount adapter

- Remove the panel mount adapter from the product if it has been delivered assembled.
- Remove the mounting bracket using a flat blade screwdriver.

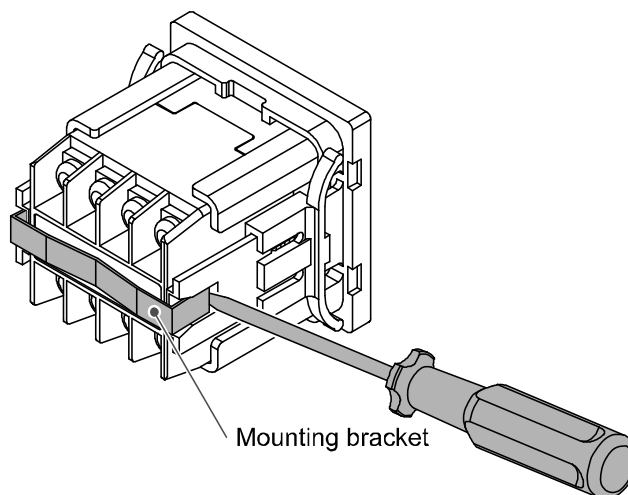

- Lever the hook to the outside to remove the adapter (See below).
- If the panel mount adapter is pulled with the hook engaged, the product or the panel mount adapter will be damaged.

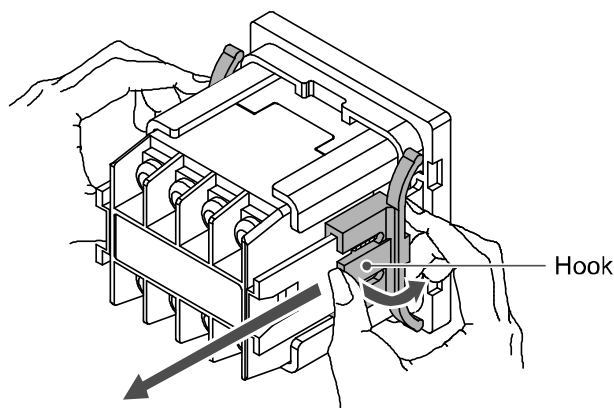

Mounting with the panel mount adapter

- Install the product as shown below.
- Insert panel mount adapter B into section A of panel mount adapter A.
 - Push panel mount adapter B from behind until the display is fixed onto the panel.
 - The pin of panel mount adapter B engages the notched part of panel adapter section A to fix the display.
- The product can be mounted on a panel with a thickness of 1.0 to 3.2 mm.
- Refer to the dimension drawing (page 40) for panel cut-out dimensions.

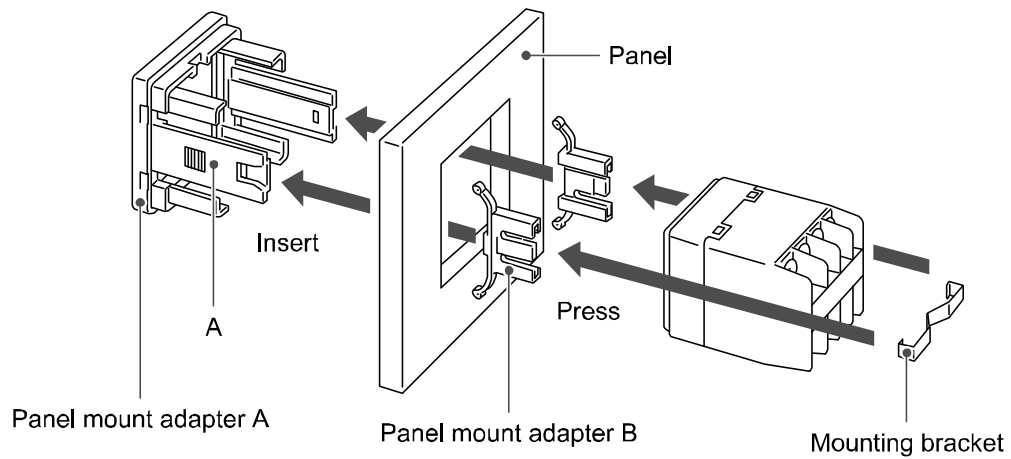

■Wiring

- Connections should only be made with the power supply turned off.
- Use separate routes for the product wiring and any power or high voltage wiring. Otherwise, malfunction may result due to noise.
- Ensure that the FG terminal is connected to ground when using a commercially available switch-mode power supply. When a switch-mode power supply is connected to the product, switching noise will be superimposed and the product specification can no longer be met. This can be prevented by inserting a noise filter, such as a line noise filter and ferrite core, between the switch-mode power supply and the product, or by using a series power supply instead of a switch-mode power supply.

●Connecting the wiring

- Do not connect the wiring when the power is on.
- Use suitable crimp terminals for connection to the terminal block.
- Attention should be paid to the terminals to avoid short circuits.

●Terminal block number

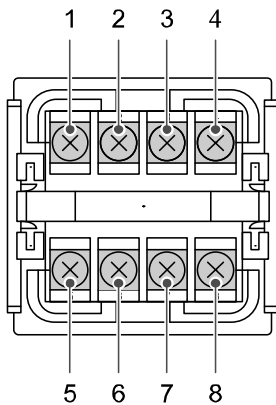

No.	Description
1	DC(-) (for sensor)
2	DC(+) (for sensor)
3	Sensor input
4	N.C.
5	DC(-) (supply voltage)
6	DC(+) (supply voltage)
7	OUT1
8	OUT2

● Internal circuit and wiring example

Use sensor PF2□5□□ series for accurate measurement.

NPN (2 outputs) type

PF2□3□0-A-□

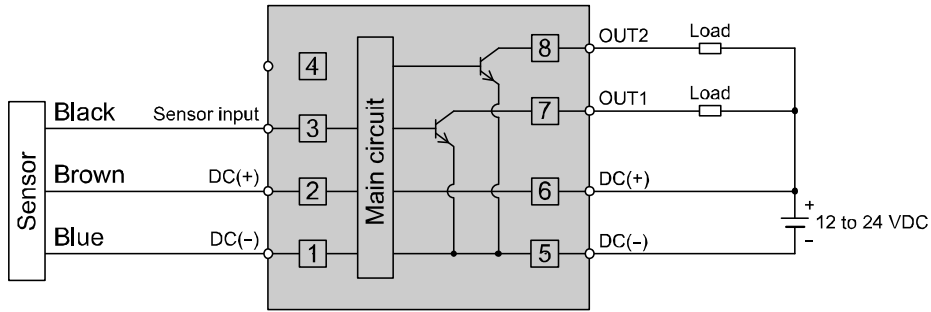

Max. 30 V, 80 mA

Internal voltage drop: 1 V or less

PNP (2 outputs) type

PF2□3□1-A-□

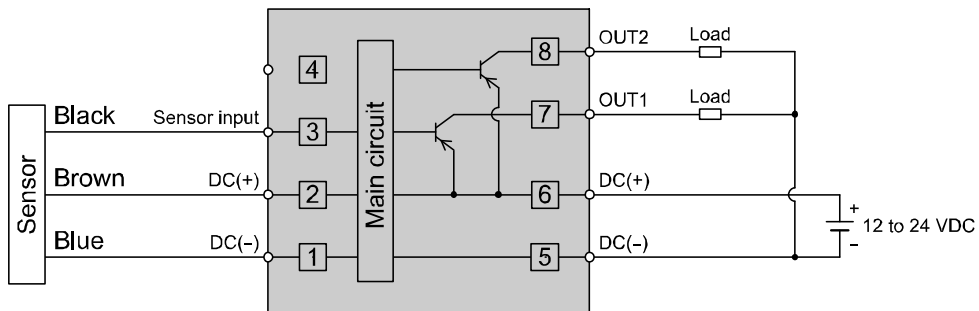

Max. 80 mA

Internal voltage drop: 1.5 V or less

Outline of setting

Power is supplied



The output will not operate for 3 seconds after supplying power.
The identification code of the product is displayed.







Measurement mode



The mode in which the flow is detected and displayed, and the switch function is operating. This is the basic operating mode; and other modes should be selected for setting changes and other function settings.

The display of instantaneous flow and accumulated flow can be changed while the  button is pressed.

While pressing the  button during the display of accumulated flow, the accumulation can be started/stopped by pressing the  button.

  button
press
for 2 sec.

  button
press.

  button
press
for 3 sec.

Initialize mode

(Refer to page 20)

Items below can be set.

- Connected sensor
- Display mode
- Unit selection function *1
- Output mode (OUT1)
- Output mode (OUT2)
- Switch operation (OUT1)
- Switch operation (OUT2)
- Reference condition *2

Function selection mode

(Refer to page 26)

Items below can be set.

- [F_1]
Input the Set value of instantaneous output
- [F_2]
Input the Set value of instantaneous output (Auto-preset)
- [F_3]
Input the Set value of accumulated output

Key-lock function

(Refer to page 31)

This function is used to prevent errors occurring due to unintentional changes of the Set values.

*1: Operate only the product with unit selection function.

*2: Operate only the PF2A3□□ series.

■List of outputs

Find the diagram of the output required in the table below. Perform settings following the Set value column on the right. Characters in () are for OUT2.

	Switch output diagram	Output mode	Switch operation	Set value	
Instantaneous flow	<p>Hysteresis ON OFF P_2 P_1 (P_4) (P_3) Instantaneous flow</p>	Instantaneous output mode 	Non-Reverse output 	Set point 2 Set point 1 *2 () Hysteresis mode	
	<p>Hysteresis *1 Hysteresis *1 ON OFF P_1 P_2 (P_3) (P_4) Instantaneous flow</p>			Set point 1 Set point 2 *2 () Window comparator mode	
	<p>Hysteresis ON OFF n_2 n_1 (n_3) (n_4) Instantaneous flow</p>			Reverse output 	Set point 2 Set point 1 *2 () Hysteresis mode
	<p>Hysteresis *1 Hysteresis *1 ON OFF n_1 n_2 (n_3) (n_4) Instantaneous flow</p>				Set point 1 Set point 2 *2 () Window comparator mode
Accumulated flow	<p>Accumulated flow 1PH+1PL (2PH+2PL) ON OFF Time</p>	Accumulated output mode 	Non-Reverse output 		Upper 3 digits Lower 3 digits *2 ()
	<p>Accumulated flow 1nH+1nL (2nH+2nL) ON OFF Time</p>				Reverse output
Accumulated pulse	<p>ON OFF 50 ms Time</p>	Accumulated pulse output mode 	Non-Reverse output 	No Set value input	
	<p>ON OFF 50 ms Time</p>			Reverse output 	No Set value input

*1: In window comparator mode, the hysteresis is fixed at 3 digits. When setting, allow 7 digits or more between Set point 1 and Set point 2 (Set point 3 and Set point 4).

*2: When Set point 1 = Set point 2 (Set point 3 = Set point 4), chattering may occur.

Initialize mode

■Default settings

●PF2A3□□ series

Item		Default settings	Page
Selection of the connected sensor	PF2A30□ series	[10L] 1 to 10 L/min type (PF2A510)	Page 21
	PF2A31□ series	[11L] 10 to 100 L/min type (PF2A511)	
Selection of display mode		[d_1] Display instantaneous flow	Page 22
Unit selection function □		[U_1] L/min	
Selection of output mode (OUT1)		[o10] Instantaneous output mode	Page 23
Selection of output mode (OUT2)		[o20] Instantaneous output mode	
Selection of switch operation (OUT1)		[1_n] Reverse output	
Selection of switch operation (OUT2)		[2_n] Reverse output	
Selection of reference condition		[Anr] Standard condition	Page 24

*: Operate only the product with unit selection function.

●PF2W3□□ series

Item		Default settings	Page
Selection of the connected sensor	PF2W30□ series	[04L] 0.5 to 4 L/min type (PF2W504)	Page 21
	PF2W33□ series	[11L] 10 to 100 L/min type (PF2W511)	
Selection of display mode		[d_1] Display instantaneous flow	Page 22
Unit selection function □		[U_1] L/min	
Selection of output mode (OUT1)		[o10] Instantaneous output mode	Page 23
Selection of output mode (OUT2)		[o20] Instantaneous output mode	
Selection of switch operation (OUT1)		[1_n] Reverse output	
Selection of switch operation (OUT2)		[2_n] Reverse output	

*: Operate only the product with unit selection function.

●PF2D3□□ series

Item		Default settings	Page
Selection of the connected sensor		[04d] 0.4 to 4 L/min type (PF2D504)	Page 21
Selection of display mode		[d_1] Display instantaneous flow	Page 22
Unit selection function □		[U_1] L/min	
Selection of output mode (OUT1)		[o10] Instantaneous output mode	Page 23
Selection of output mode (OUT2)		[o20] Instantaneous output mode	
Selection of switch operation (OUT1)		[1_n] Reverse output	
Selection of switch operation (OUT2)		[2_n] Reverse output	

*: Operate only the product with unit selection function.

■ Setting procedure of Initialize mode

<Operation>

Press the  button for 2 seconds or longer during measurement mode.

Selection of the connected sensor

The sensor to be connected is selectable before using the product.

If the select connected sensor is changed, the Set value and the accumulated value are return to default setting.

Press the  button to select.

•PF2A30□ series

- [10L]: 1 to 10 L/min type (PF2A510)
- [50L]: 5 to 50 L/min type (PF2A550)

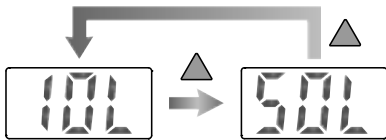

•PF2A31□ series

- [11L]: 10 to 100 L/min type (PF2A511)
- [21L]: 20 to 200 L/min type (PF2A521)
- [51L]: 50 to 500 L/min type (PF2A551)



•PF2W30□ series

- [04L]: 0.5 to 4 L/min type (PF2W504)
- [20L]: 2 to 16 L/min type (PF2W520)
- [40L]: 5 to 40 L/min type (PF2W540)



•PF2W33□ series

- [11L]: 10 to 100 L/min type (PF2W511)

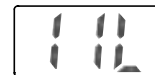

•PF2D30□ series

- [04d]: 0.4 to 4 L/min type (PF2D504)
- [20d]: 1.8 to 20 L/min type (PF2D520)
- [40d]: 4 to 40 L/min type (PF2D540)



↓ Press the  button. (continued)



Selection of display mode

Select the display of instantaneous flow or accumulated flow.

Press the button to select.

- [d_1]: display instantaneous flow
- [d_2]: display accumulated flow

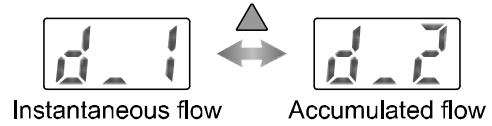

The product with unit selection function

Press the button.

SI unit only

Unit selection function

The display unit can only be selected for products with unit selection function.

Press the button to select.



•PF2A3□□ series

Display	Instantaneous flow	Accumulated flow
[U_1]	L/min	L
[U_2] *	CFM x 10 ⁻² , CFM x 10 ⁻¹	ft ³ x 10 ⁻¹ , ft ³ x 10 ⁻²

•PF2W3□□ series

Display	Instantaneous flow	Accumulated flow
[U_1]	L/min	L
[U_2] *	gal(US)/min	gal(US)

•PF2D3□□ series

Display	Instantaneous flow	Accumulated flow
[U_1]	L/min	L
[U_2] *	gal(US)/min	gal(US)

*: Refer to page 25 for the flow rate when [U_2] is selected.



Press the button. (continued)





Selection of output mode (OUT1)

Select the switch output mode required referring to the list of outputs (page 19).

Press the ▲ button to select.

- [o10]: Instantaneous output mode
- [o11]: Accumulated output mode
- [o12]: Accumulated pulse output mode

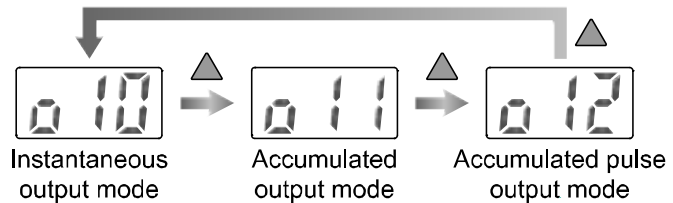

Press the SET button.

Selection of output mode (OUT2)

Select the switch output mode required referring to the list of outputs (page 19).

Press the ▲ button to select.

- [o20]: Instantaneous output mode
- [o21]: Accumulated output mode
- [o22]: Accumulated pulse output mode

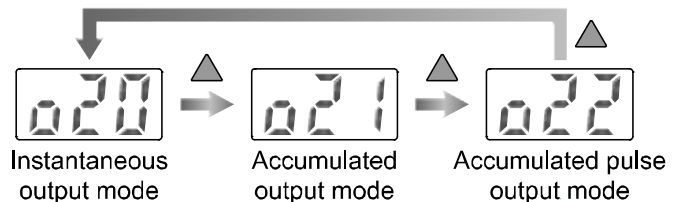

Press the SET button.

Selection of switch operation (OUT1)

Select the switch operation required referring to the list of outputs (page 19).

Press the ▲ button to select.

- [1_n]: Reverse output
- [1_P]: Non-Reverse output

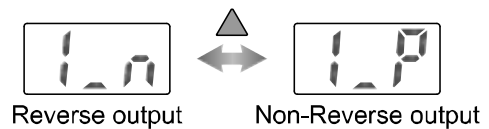

Press the SET button.

Selection of switch operation (OUT2)

Select the switch operation required referring to the list of outputs (page 19).

Press the ▲ button to select.

- [2_n]: Reverse output
- [2_P]: Non-Reverse output

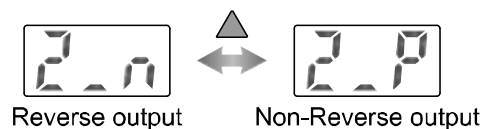

Press the SET button. (continued)



Selection of reference condition

Operate only the PF2A3□□ series.

Select standard condition or normal condition for the display unit.

Press the ▲ button to select.

- [Anr]: Standard condition.
Flow display which is converted in atmospheric pressure at 20 °C, 65%R.H.
- [nor]: Normal condition.
Flow display which is converted in atmospheric pressure at 0 °C.

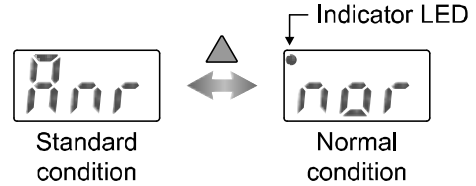

*: Flow rate in the specification is the value at standard condition.

If the display unit standard is changed from standard to normal, use the conversion formula.

Flow rate at standard condition x 0.927 = Flow rate at normal condition

*: When [nor] is selected, an Indicator LED [•] appears on the upper left of the screen.



Press the SET button.

Setting of initialize mode is completed.
Return to measurement mode.

Flow specification when [U_2] is selected by the unit selection function

•PF2A3□□ series

Model		PF2A30□		PF2A31□			
Applicable sensor		PF2A510	PF2A550	PF2A511	PF2A521	PF2A551	
Flow	Rated flow range	3.5 to 35.5 CFM x 10 ⁻²	18 to 176 CFM x 10 ⁻²	3.5 to 35.5 CFM x 10 ⁻¹	7 to 71 CFM x 10 ⁻¹	18 to 176 CFM x 10 ⁻¹	
	Instantaneous flow	Setting/display flow range *	1.0 to 38.0 CFM x 10 ⁻²	8 to 186 CFM x 10 ⁻²	1.0 to 38.0 CFM x 10 ⁻¹	2 to 76 CFM x 10 ⁻¹	8 to 186 CFM x 10 ⁻¹
		Min. setting/display unit	0.5 CFM x 10 ⁻²	2.0 CFM x 10 ⁻²	0.5 CFM x 10 ⁻¹	1.0 CFM x 10 ⁻¹	2.0 CFM x 10 ⁻¹
	Accumulated flow	Setting/display flow range	0 to 999999 ft ³ x 10 ⁻²		0 to 999999 ft ³ x 10 ⁻¹		
		Min. setting/display unit	1 ft ³ x 10 ⁻³		1 ft ³ x 10 ⁻¹		
Conversion of accumulated pulse		0.5 ft ³ x 10 ⁻² /pulse	2.0 ft ³ x 10 ⁻² /pulse	0.5 ft ³ x 10 ⁻¹ /pulse	1.0 ft ³ x 10 ⁻¹ /pulse	2.0 ft ³ x 10 ⁻¹ /pulse	

*: Flow rate in the specification is the value at standard condition.

If the display unit standard is changed from standard to normal, use the conversion formula.

Flow rate at standard condition x 0.927 = Flow rate at normal condition

•PF2W3□□ series

Model		PF2W30□			PF2W33□	
Applicable sensor		PF2W504	PF2W520	PF2W540	PF2W511	
Flow	Rated flow range	0.13 to 1.06 gal(US)/min	0.55 to 4.25 gal(US)/min	1.3 to 10.6 gal(US)/min	2.6 to 26.4 gal(US)/min	
	Instantaneous flow	Setting/display flow range	0.10 to 1.16 gal(US)/min	0.40 to 4.75 gal(US)/min	1.0 to 11.6 gal(US)/min	7 to 110 gal(US)/min
		Min. setting/display unit	0.01 gal(US)/min	0.05 gal(US)/min	0.1 gal(US)/min	0.2 gal(US)/min
	Accumulated flow	Setting/display flow range	0 to 999999 gal(US)			
		Min. setting/display unit	1 gal(US)			
Conversion of accumulated pulse		0.01 gal(US)/pulse	0.05 gal(US)/pulse	0.1 gal(US)/pulse	0.2 gal(US)/pulse	

•PF2D3□□ series

Model		PF2D30□			
Applicable sensor		PF2D504	PF2D520	PF2D540	
Flow	Rated flow range	0.11 to 1.06 gal(US)/min	0/40 to 5.30 gal(US)/min	1.1 to 10.6 gal(US)/min	
	Instantaneous flow	Setting/display flow range	0.9 to 1.16 gal(US)/min	0.25 to 5.80 gal(US)/min	0.9 to 11.6 gal(US)/min
		Min. setting/display unit	0.01 gal(US)/min	0.05 gal(US)/min	0.1 gal(US)/min
	Accumulated flow	Setting/display flow range	0 to 999999 gal(US)		
		Min. setting/display unit	1 gal(US)		
Conversion of accumulated pulse		0.01 gal(US)/pulse	0.05 gal(US)/pulse	0.1 gal(US)/pulse	

Function selection mode

Function selection mode

In measurement mode, press the  button, to display [F_□].

This [F_□] indicates the mode for changing each functional setting.

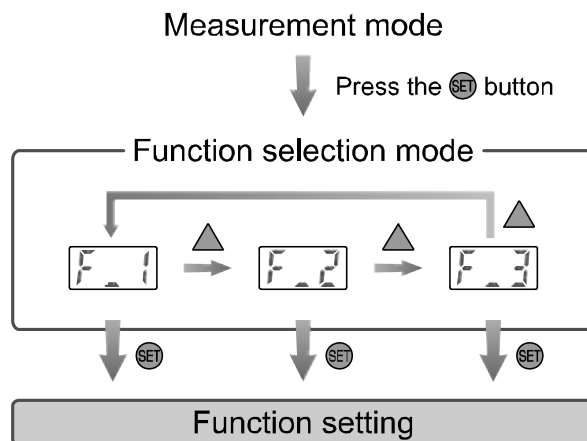

*: When OUT1 or OUT2 is assigned to be instantaneous output mode during initialize mode, [F_1] and [F_2] are displayed.

When OUT1 or OUT2 is assigned to be accumulated output mode, [F_3] is displayed.

■ Default settings

Item		Default Setting	Page
[F_1] Input the Set value of instantaneous output	[n_1] * Input of the Set point 1 (OUT1)	50% of max. rated flow	Page 27
	[n_2] * Input of the Set point 2 (OUT1)	PF2A30□: [5. 0] L/min (PF2A510) PF2A31□: [50] L/min (PF2A511)	
	[n_3] * Input of the Set point 3 (OUT2)	PF2W30□: [2. 00] L/min (PF2W504) PF2W33□: [50] L/min (PF2W511)	
	[n_4] * Input of the Set point 4 (OUT2)	PF2D30□: [2. 00] L/min (PF2D504)	
[F_2] Input the Set value of instantaneous output (Auto-preset)	-	-	Page 28
[F_3] Input the Set value of accumulated output	[1nL] * Input of the Set value for the lower 3 digits (OUT1)	[0]	Page 29
	[1nH] * Input of the Set value for the upper 3 digits (OUT1)	[0]	
	[2nL] * Input of the Set value for the lower 3 digits (OUT2)	[0]	
	[2nH] * Input of the Set value for the upper 3 digits (OUT2)	[0]	

*: When Non-Reverse output is selected as the switching operation, n becomes P.

■[F_1] Input procedure of the Set value of instantaneous output



The Set point of the switch output can be set manually.

<Operation>

Press the  button in function selection mode to display [F_1]. (When OUT1 or OUT2 is assigned to be accumulated output mode, [F_1] is displayed.)

↓ Press the  button.

Input of the Set point 1 (OUT1)

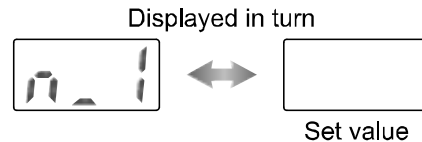

[n_1]* and the current Set value are displayed in turn. Press the  and  button to change the value referring to the list of outputs (page 19).



*: When Non-Reverse output is selected as the switch operation, [P_1] is displayed.

↓ Press the  button.

Input of the Set point 2 (OUT1)

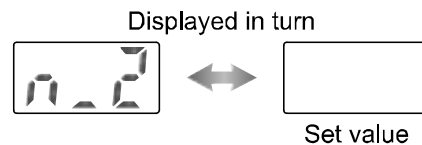

[n_2]* and the current Set value are displayed in turn. Press the  and  button to change the value referring to the list of outputs (page 19).



*: When Non-Reverse output is selected as the switch operation, [P_2] is displayed.

↓ Press the  button.

Input of the Set point 3 (OUT2)

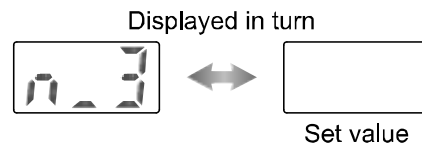

[n_3]* and the current Set value are displayed in turn. Press the  and  button to change the value referring to the list of outputs (page 19).



*: When Non-Reverse output is selected as the switch operation, [P_3] is displayed.

↓ Press the  button.

Input of the Set point 4 (OUT2)

[n_4]* and the current Set value are displayed in turn. Press the  and  button to change the value referring to the list of outputs (page 19).

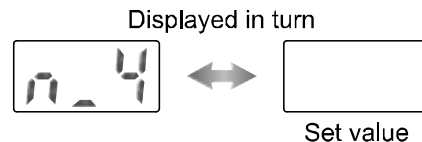

*: When Non-Reverse output is selected as the switch operation, [P_4] is displayed.

↓ Press the  button.

[F_1] Input procedure of the Set value of instantaneous output is completed.
Return to measurement mode.

■ [F_2] Input procedure of the Set value of instantaneous output (Auto-preset)

The Set point of the switch output can be automatically set referring to actual flow.

<Operation>

Press the ▲ button in function selection mode to display [F_2]. (When OUT1 or OUT2 is assigned to be accumulate output mode, [F_2] is displayed.)

↓ Press the  button.

Measurement of the Set value (OUT1)

[AP1] is displayed.

Apply flow rate to set for OUT1.



*: If setting of OUT1 is not necessary, press the ▲ and ▼ buttons simultaneously.
Moves on to the measurement of OUT2 Set value.

↓ Press the  button.

[A1L] and the Set value are displayed in turn.
The flow rate is read automatically,
and the Set value is set.
A value 3 digits below is set as hysteresis.

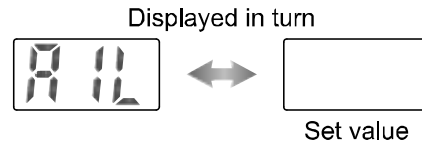

↓ Press the  button.

Measurement of the Set value (OUT2)

[AP2] is displayed.

Apply flow rate to set for OUT2.



*: If setting of OUT1 is not necessary, press the ▲ and ▼ buttons simultaneously.
Return to the measurement mode.

↓ Press the  button.

[A2L] and the Set value are displayed in turn.
The flow rate is read automatically,
and the Set value is set.
A value 3 digits below is set as hysteresis.

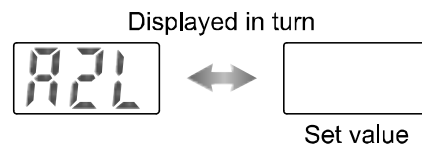

↓ Press the  button.

[F_2] Input procedure of the Set value of instantaneous output (Auto-preset) is completed.
Return to measurement mode.

■ [F_3] Input procedure of the Set value of accumulated output

The Set point of the switch output can be manually set. Accumulated flow rate is displayed by the lower 3 digits and upper 3 digits separately. Setting is performed separately.

<Operation>

Press the ▲ button in function selection mode to display [F_3]. (When both OUT1 and OUT2 are assigned to be instantaneous output mode or accumulated output mode, [F_3] is not displayed. When OUT1 or OUT2 is assigned to be accumulated output mode, [F_3] is displayed.)

↓ Press the  button.

Input of the Set value for the lower 3 digits (OUT1)

[1nL]* and the current Set value are displayed in turn. Press the ▲ and ▼ button to change the value referring to the list of outputs (page 19).

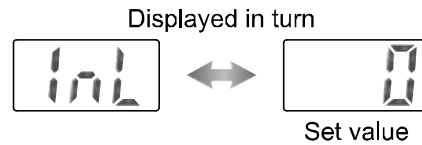

*: When Non-Reverse output is selected as the switch operation, [1PL] is displayed.

↓ Press the  button.

Input of the Set value for the upper 3 digits (OUT1)

[1nH]* and the current Set value are displayed in turn. Press the ▲ and ▼ button to change the value referring to the list of outputs (page 19).

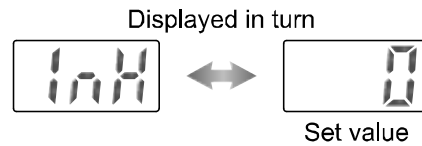

*: When Non-Reverse output is selected as the switch operation, [1PH] is displayed.

↓ Press the  button.

Input of the Set value for the lower 3 digits (OUT2)

[2nL]* and the current Set value are displayed in turn. Press the ▲ and ▼ button to change the value referring to the list of outputs (page 19).

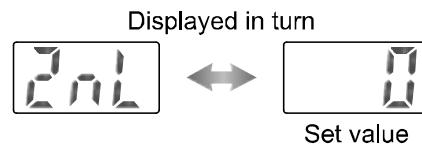

*: When Non-Reverse output is selected as the switch operation, [2PL] is displayed.

↓ Press the  button.

Input of the Set value for the upper 3 digits (OUT2)

[2nH]* and the current Set value are displayed in turn. Press the ▲ and ▼ button to change the value referring to the list of outputs (page 19).

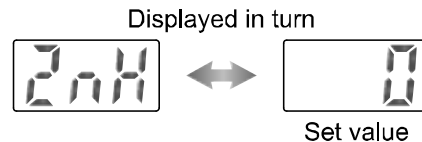



*: When Non-Reverse output is selected as the switch operation, [2PH] is displayed.

↓ Press the  button. (continued)

[F_3] Input procedure of the Set value of accumulated output is completed.
Return to measurement mode.

Starting of accumulation

Check that the display of accumulated flow rate is selected as the display mode.

Press the  and  buttons simultaneously in measurement mode.

[-] flashes and accumulation starts.



Stop and restart of accumulation are performed the same way.



Pressing the  button displays the instantaneous flow rate while displaying the accumulated flow.

The accumulated flow rate can be displayed up to 999,999 L, but the display normally shows the lower 3 digits.

Press the  button to display the upper 3 digits.

The display flashes when the value reaches 999,999 L. To reset the accumulated value, press the  and  buttons simultaneously for 2 seconds or longer.





The accumulated value will be reset if the power supply is turned off.

Key-lock function

This function is used to prevent errors occurring due to unintentional changes of the Set values.

<How to lock>

1. Press the  button for 3 seconds or longer in measurement mode. The display will change from [F_□] to [□□L] ([□□d]) to [unL]. When [unL] is displayed, release  button.

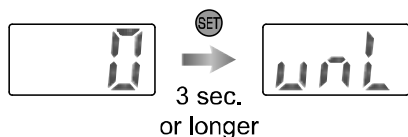

2. Press the  button to select [Loc], to lock the keys.

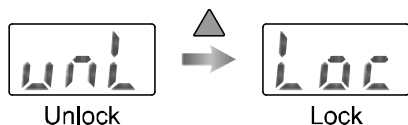

3. Key operation is locked by pressing the  button, and returns to measurement mode.



*: Even when keys are locked, while the  button is pressed, instantaneous flow and accumulated flow can be displayed in turn.

<How to unlock>

1. Press the  button for 3 seconds or longer in measurement mode.

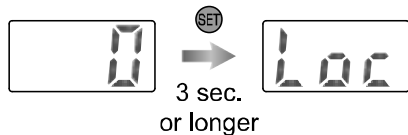

2. Press the  button to select [unL], to unlock the keys.

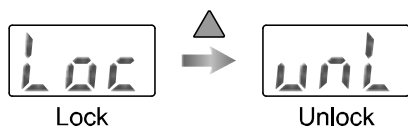

3. Key operation is unlocked by pressing the  button, and returns to measurement mode.



Maintenance

How to reset the product after a power cut or forcible de-energizing

The setting of the product will be retained as it was before a power cut or de-energizing.

The output condition is also basically recovered to that before a power cut or de-energizing, but may change depending on the operating environment.

Therefore, check the safety of the whole installation before operating the product.

Troubleshooting

Troubleshooting

If an operation failure occurs with the product, use the table below to find out the cause of the problem. If none of the countermeasures seem to be applicable, or a replacement product operates normally when installed, the product may be faulty. A product can be damaged by the operating environment (system configuration etc). If the product seems to be faulty, please contact SMC.

■ Cross-reference for troubleshooting

Fault		Probable cause	Recommended action
Display	Display is OFF.	Wiring failure.	Correct the wiring.
		Connector loose.	Check the connector.
	The display is unstable.	Foreign matter inside.	Refer to the operation manual of the sensor.
		Piping is connected in the wrong direction.	Install the sensor with the mounting direction corresponding to the flow direction (arrow indicated on the sensor body).
		Insufficient fluid supply. *1	Check the fluid path.
		Pulsation in the flow.	It is possible that pulsation is generated due to the fluctuation of the supply pressure or the characteristics of the compressor or pump used as the pressure source. Change to a pressure source with less fluctuation or install a tank which reduces the pressure fluctuation.
		Fluid leakage	Refer to the operation manual of the sensor.
	The display is not correct.	Foreign matter inside.	Refer to the operation manual of the sensor.
		Piping is connected in the wrong direction.	Make the mounting direction (the arrow indicated on the side of the sensor body or the product label) correspond to the flow direction.
		Insufficient fluid supply. *1	Check the fluid path.
		An incorrect flow unit was selected. *2	Select the appropriate flow unit.
		Fluid leakage	Refer to the operation manual of the sensor.

*1: Operate only the PF2W3□□ and PF2D3□□ series.

*2: Operate only the product with unit selection function.

Fault		Probable cause	Recommended action
Output	There is no output.	Wiring failure.	Correct the wiring.
		Connector loose.	Check the connector.
	Output is unstable.	Foreign matter inside.	Refer to the operation manual of the sensor.
		Piping is connected in the wrong direction.	Install the sensor with the mounting direction corresponding to the flow direction (arrow indicated on the sensor body).
		Insufficient fluid supply. *1	Check the fluid path.
		Pulsation in the flow.	It is possible that pulsation is generated due to the fluctuation of the supply pressure or the characteristics of the compressor or pump used as the pressure source. Change to a pressure source with less fluctuation or install a tank which reduces the pressure fluctuation.
		Fluid leakage	Refer to the operation manual of the sensor.
Hysteresis is narrow.	Increase the hysteresis.		
Button	The buttons cannot be operated.	Key-lock function is activated.	Cancel the key-lock function (page 31).

*1: Operate only the PF2W3□□ and PF2D3□□ series.

■ Error indication

Error Name	Error Display	Error Type	Troubleshooting Method
Excessive instantaneous flow	- - -	Flow has exceeded the upper limit of the display flow range.	Reduce the flow.
OUT1 over current error	Er1	The switch output load current is more than 80 mA (OUT1).	Turn the power off and remove the cause of the over current. Then turn the power on again.
OUT2 over current error	Er2	The switch output load current is more than 80 mA (OUT2).	
System error	Er4	The set data has been changed unexpectedly.	To reset, press ▲ and ▼ buttons simultaneously for 2 seconds or longer. Then set all data again.
Excessive accumulated flow	-999- Accumulated flow displayed (flashing)	The display flow range of accumulated flow has been exceeded.	To reset the accumulated flow value, press ▲ and ▼ buttons simultaneously for 2 seconds or longer.

*: If the error cannot be reset after the above measures are taken, then please contact SMC.

Specifications

■ Specifications

● PF2A3□□

Model		PF2A3□□					
Applicable sensor		PF2A510	PF2A550	PF2A511	PF2A521	PF2A551	
Flow	Rated flow range	1 to 10 L/min	5 to 50 L/min	10 to 100 L/min	20 to 200 L/min	50 to 500 L/min	
	Instantaneous flow	Setting/display flow range *1 *2	0.5 to 10.5 L/min	2.5 to 52.5 L/min	5 to 105 L/min	10 to 210 L/min	25 to 525 L/min
		Min. setting/display unit	0.1 L/min	0.5 L/min	1.0 L/min	2.0 L/min	5.0 L/min
	Accumulated Flow	Setting/display flow range	0 to 999999 L				
		Min. setting/display unit	1 L				
Reference condition *3		Standard condition, Normal condition *4					
Switch output	Output mode *3		NPN open collector output, PNP open collector output Instantaneous flow output mode (hysteresis mode, window comparator mode) Accumulated flow output mode, Accumulated pulse output mode				
	Switch operation *3		Non-Reversed output, Reversed output				
	Max. load current		80 mA				
	Max. applied voltage		30 VDC (NPN output)				
	Internal voltage drop		NPN output: 1 V or less (at 80 mA) PNP output: 1.5 V or less (at 80 mA)				
	Response time		1 s or less				
	Repeatability *5		±1%F.S. max.				
	Accuracy *5		±5%F.S. max.				
	Hysteresis		Hysteresis mode: Variable *3 Window comparator mode: Fixed (3 digits)				
	Output protection		Short circuit protection				
	Accumulated pulse	Pulse width	50 ms				
		Conversion of accumulated pulse	0.1 L/pulse	0.5 L/pulse	1 L/pulse	2 L/pulse	5 L/pulse
Supply voltage		12 to 24 VDC±10%					
Power consumption (No load)		50 mA or less		60 mA or less			
Temperature characteristics		±1%F.S. max. (15 to 35 °C, 25 °C reference) ±2%F.S. max. (0 to 50 °C, 25 °C reference)					

*1: Display flow range in the specification is the value at standard condition.

If the display unit standard is changed from standard to normal, use the conversion formula.

Flow rate at standard condition x 0.927 = Flow rate at normal condition

*2: If the flow rate is smaller than the minimum flow of the display range, "0 L/min" is displayed.

*3: Selectable by setting.

*4: Standard condition: Flow display which is converted in atmospheric pressure at 20 °C, 65%R.H.

Normal condition: Flow display which is converted in atmospheric pressure at 0 °C.

*5: Total accuracy when used with applicable sensor.

•PF2W3□□

Model		PF2W3□□				
Applicable sensor		PF2W504(T)	PF2W520(T)	PF2W540(T)	PF2W511(T)	
Flow	Rated flow range	0.5 to 4.0 L/min	2 to 16 L/min	5 to 40 L/min	10 to 100 L/min	
	Instantaneous flow	Setting/display flow range *1	0.35 to 4.50 L/min	1.7 to 17.0 L/min	3.5 to 45.0 L/min	7 to 110 L/min
		Min. setting/display unit	0.05 L/min	0.1 L/min	0.5 L/min	1 L/min
	Accumulated Flow	Setting/display flow range	0 to 999999 L			
Min. setting/display unit		1 L				
Switch output	NPN open collector output, PNP open collector output					
	Output mode *2	Instantaneous flow output mode (hysteresis mode, window comparator mode) Accumulated flow output mode, Accumulated pulse output mode				
	Switch operation *2	Non-Reversed output, Reversed output				
	Max. load current	80 mA				
	Max. applied voltage	30 VDC (NPN output)				
	Internal voltage drop	NPN output: 1 V or less (at 80 mA) PNP output: 1.5 V or less (at 80 mA)				
	Response time	1 s or less				
	Repeatability *3	±3%F.S. max.			±1%F.S. max.	
	Accuracy *3	±5%F.S. max.			±3%F.S. max.	
	Hysteresis	Hysteresis mode: Variable *2 Window comparator mode: Fixed (3 digits)				
	Output protection	Short circuit protection				
Accumulated pulse	Pulse width	50 ms				
	Conversion of accumulated pulse	0.05 L/pulse	0.1 L/pulse	0.5 L/pulse	1 L/pulse	
Supply voltage	12 to 24 VDC±10%					
Power consumption (No load)	50 mA or less				60 mA or less	
Temperature characteristics	±5%F.S. max. (0 to 50 °C, 25 °C reference)				±1%F.S. max. (15 to 35 °C, 25 °C reference) ±2%F.S. max. (0 to 50 °C, 25 °C reference)	

*1: If the flow rate is smaller than the minimum flow of the display range, "0 L/min" is displayed.

*2: Selectable by setting.

*3: Total accuracy when used with applicable sensor.

●PF2D3□□

Model		PF2D3□□				
Applicable sensor		PF2D504	PF2D520	PF2D540		
Flow	Rated flow range		0.4 to 4.0 L/min	1.8 to 20.0 L/min	4 to 40 L/min	
	Instantaneous flow	Setting/display flow range *1	0.25 to 4.50 L/min	1.3 to 21.0 L/min	2.5 to 45.0 L/min	
		Min. setting/display unit	0.05 L/min	0.1 L/min	0.5 L/min	
	Accumulated Flow	Setting/display flow range	0 to 999999 L			
		Min. setting/display unit	1 L			
Switch output			NPN open collector output, PNP open collector output			
	Output mode *2		Instantaneous flow output mode (hysteresis mode, window comparator mode) Accumulated flow output mode, Accumulated pulse output mode			
	Switch operation *2		Non-Reversed output, Reversed output			
	Max. load current		80 mA			
	Max. applied voltage		30 VDC (NPN output)			
	Internal voltage drop		NPN output: 1 V or less (at 80 mA) PNP output: 1.5 V or less (at 80 mA)			
	Response time		1 s or less			
	Repeatability *3		±0.5%F.S. max.			
	Accuracy *3		±0.5%F.S. max.			
	Hysteresis		Hysteresis mode: Variable *2 Window comparator mode: Fixed (3 digits)			
	Output protection		Short circuit protection			
	Accumulated pulse	Pulse width		50 ms		
		Conversion of accumulated pulse		0.05 L/pulse	0.1 L/pulse	0.5 L/pulse
Supply voltage		12 to 24 VDC±10%				
Power consumption (No load)		60 mA or less				
Temperature characteristics		±1%F.S. max. (15 to 35 °C, 25 °C reference) ±2%F.S. max. (0 to 50 °C, 25 °C reference)				

*1: If the flow rate is smaller than the minimum flow of the display range, "0 L/min" is displayed.

*2: Selectable by setting.

*3: Total accuracy when used with applicable sensor.

•Common Specifications

Model		PF2□3□□
Display	Display part	Displayed digit: 3 digits 7 segments, Colour: Red
	Indicator LED	OUT1: When ON, Green LED ON OUT2: When ON, Red LED is ON
Environment	Enclosure	IP40
	Operating temperature range	Operation: 0 to 50 °C, Storage: -25 to 85 °C (no freezing or condensation)
	Operating humidity range	Operation, Storage: 35 to 85%R.H. (no condensation)
	Withstand voltage	1000 VAC, for 1 minute between the external terminals and case
	Insulation resistance	50 MΩ or more (with 500 VDC mega meter) between the external terminals and case
Standards and regulations		CE, RoHS
Materials		Enclosure: m-PPO, Terminal block: brass Panel mount adapter: POM, m-PPO, SUS
Weight		45 g

■ Dimensions (in mm)

PF2□3□□ + Panel mount adapter (ZS-22-E)

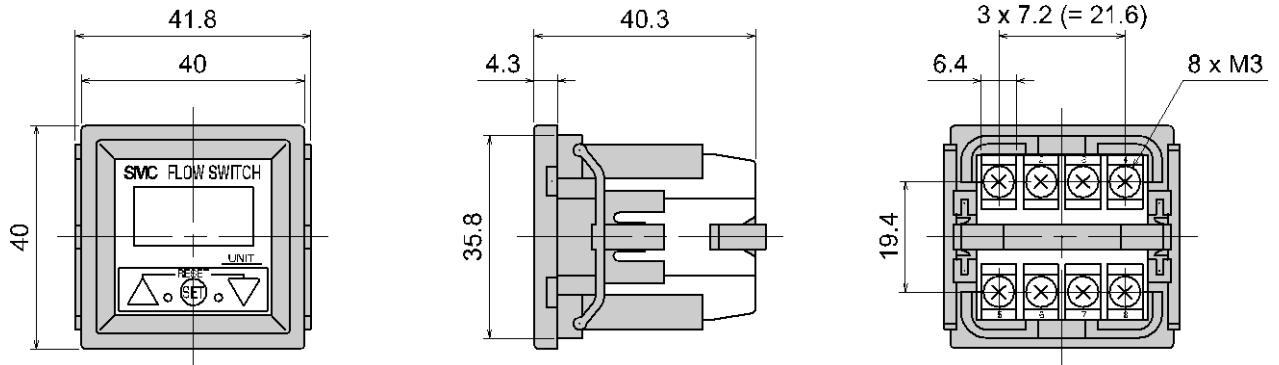

Panel cut-out dimensions

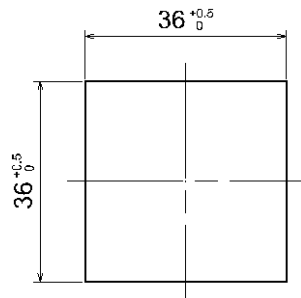

*: Suitable for panel thickness of 1 to 3.2 mm.

Revision history

- A: Full scale revision due to the change of the format and addition of items.
- B: Content is changed due to the change of the format.
- C: Modified errors in text.
- D: Contents revised in several places.
- E: Modified errors in text.
- F: Contents revised in several places. [July 2018]

SMC Corporation

4-14-1, Sotokanda, Chiyoda-ku, Tokyo 101-0021 JAPAN

Tel: + 81 3 5207 8249 Fax: +81 3 5298 5362

URL <http://www.smcworld.com>

Note: Specifications are subject to change without prior notice and any obligation on the part of the manufacturer.
© 2011-2018 SMC Corporation All Rights Reserved

