



Operation Manual

PRODUCT NAME

Digital Flow Switch
( IO-Link compatible)

MODEL / Series / Product Number

PFMC7501-L
PFMC7102-L
PFMC7202-L

SMC Corporation

Contents

Safety Instructions	3
Model Indication and How to Order	11
Summary of Product parts	12
Definition and terminology	14
Mounting and Installation	16
Installation	17
Piping	19
Wiring	20
Outline of Settings [Measurement mode]	26
Flow Setting (set value only) of OUT1 · OUT2 [3 step setting mode]	27
Default settings	31
Simple Setting Mode	29
Function Setting [Function selection mode]	30
Default settings	31
[F 0] Selection of reference condition, unit selection function, switch output specifications	32
[F 1] Setting of OUT1	35
[F 2] Setting of OUT2	42
[F 3] Digital filter setting	48
[F10] Sub screen setting	49
[F14] Zero-cut setting	55
[F20] Setting of external input	56
[F22] Analogue output setting	57
[F30] Accumulated flow value hold setting	58
[F80] Display OFF mode setting	59
[F81] Setting of security code	60
[F90] Setting of all function	62
[F96] Check of input signal	63
[F98] Setting of output check	64
[F99] Reset to default settings Other Functions	67

Other Functions	68
Maintenance	72
IO-Link Specifications	72
Outline of IO-Link functions	72
Communication specifications	72
Process data	73
IO-Link parameter setting	76
Troubleshooting	85
Specifications	89
Characteristics data	92
Dimensions	95



Safety Instructions

These safety instructions are intended to prevent hazardous situations and/or equipment damage. These instructions indicate the level of potential hazard with the labels of "Caution", "Warning" or "Danger". They are all important notes for safety and must be followed in addition to International Standards (ISO/IEC)*1), and other safety regulations.

*1) ISO 4414: Pneumatic fluid power -- General rules relating to systems.

ISO 4413: Hydraulic fluid power -- General rules relating to systems.

IEC 60204-1: Safety of machinery -- Electrical equipment of machines. (Part 1: General requirements)

ISO 10218: Manipulating industrial robots -Safety.
etc.



Caution

Caution indicates a hazard with a low level of risk which, if not avoided, could result in minor or moderate injury.



Warning

Warning indicates a hazard with a medium level of risk which, if not avoided, could result in death or serious injury.



Danger

Danger indicates a hazard with a high level of risk which, if not avoided, will result in death or serious injury.

Warning

1. The compatibility of the product is the responsibility of the person who designs the equipment or decides its specifications.

Since the product specified here is used under various operating conditions, its compatibility with specific equipment must be decided by the person who designs the equipment or decides its specifications based on necessary analysis and test results.

The expected performance and safety assurance of the equipment will be the responsibility of the person who has determined its compatibility with the product.

This person should also continuously review all specifications of the product referring to its latest catalog information, with a view to giving due consideration to any possibility of equipment failure when configuring the equipment.

2. Only personnel with appropriate training should operate machinery and equipment.

The product specified here may become unsafe if handled incorrectly.

The assembly, operation and maintenance of machines or equipment including our products must be performed by an operator who is appropriately trained and experienced.

3. Do not service or attempt to remove product and machinery/equipment until safety is confirmed.

1. The inspection and maintenance of machinery/equipment should only be performed after measures to prevent falling or runaway of the driven objects have been confirmed.

2. When the product is to be removed, confirm that the safety measures as mentioned above are implemented and the power from any appropriate source is cut, and read and understand the specific product precautions of all relevant products carefully.

3. Before machinery/equipment is restarted, take measures to prevent unexpected operation and malfunction.

4. Contact SMC beforehand and take special consideration of safety measures if the product is to be used in any of the following conditions.

1. Conditions and environments outside of the given specifications, or use outdoors or in a place exposed to direct sunlight.

2. Installation on equipment in conjunction with atomic energy, railways, air navigation, space, shipping, vehicles, military, medical treatment, combustion and recreation, or equipment in contact with food and beverages, emergency stop circuits, clutch and brake circuits in press applications, safety equipment or other applications unsuitable for the standard specifications described in the product catalog.

3. An application which could have negative effects on people, property, or animals requiring special safety analysis.

4. Use in an interlock circuit, which requires the provision of double interlock for possible failure by using a mechanical protective function, and periodical checks to confirm proper operation.



Safety Instructions

Caution

1. The product is provided for use in manufacturing industries.

The product herein described is basically provided for peaceful use in manufacturing industries. If considering using the product in other industries, consult SMC beforehand and exchange specifications or a contract if necessary.
If anything is unclear, contact your nearest sales branch.

Limited warranty and Disclaimer/Compliance Requirements

The product used is subject to the following "Limited warranty and Disclaimer" and "Compliance Requirements".

Read and accept them before using the product.

Limited warranty and Disclaimer

1. The warranty period of the product is 1 year in service or 1.5 years after the product is delivered, whichever is first.*2)

Also, the product may have specified durability, running distance or replacement parts. Please consult your nearest sales branch.

2. For any failure or damage reported within the warranty period which is clearly our responsibility, a replacement product or necessary parts will be provided.

This limited warranty applies only to our product independently, and not to any other damage incurred due to the failure of the product.

3. Prior to using SMC products, please read and understand the warranty terms and disclaimers noted in the specified catalog for the particular products.

***2) Vacuum pads are excluded from this 1 year warranty.**

A vacuum pad is a consumable part, so it is warranted for a year after it is delivered.

Also, even within the warranty period, the wear of a product due to the use of the vacuum pad or failure due to the deterioration of rubber material are not covered by the limited warranty.

Compliance Requirements

1. The use of SMC products with production equipment for the manufacture of weapons of mass destruction (WMD) or any other weapon is strictly prohibited.

2. The exports of SMC products or technology from one country to another are governed by the relevant security laws and regulation of the countries involved in the transaction. Prior to the shipment of a SMC product to another country, assure that all local rules governing that export are known and followed.

Caution

SMC products are not intended for use as instruments for legal metrology.

Products that SMC manufactures or sells are not measurement instruments that are qualified by pattern approval tests relating to the measurement laws of each country.

Therefore, SMC products cannot be used for business or certification ordained by the measurement laws of each country.

Operator

- ◆ This operation manual is intended for those who have knowledge of machinery using pneumatic equipment, and have sufficient knowledge of assembly, operation and maintenance of such equipment. Only those persons are allowed to perform assembly, operation and maintenance.
- ◆ Read and understand this operation manual carefully before assembling, operating or providing maintenance to the product.

■ Safety Instructions

Warning

- Do not disassemble, modify (including changing the printed circuit board) or repair.
An injury or failure can result.
- Do not operate the product outside of the specifications.
Do not use for flammable or harmful fluids.
Fire, malfunction, or damage to the product can result.
Verify the specifications before use.
- Do not operate in an atmosphere containing flammable, explosive or corrosive gas.
Fire, explosion or corrosion can result.
This product is not designed to be explosion proof.
- Do not use the product for flammable fluid.
Fire or explosion can result.
Only air and N₂ are applicable.
- Do not use the product in a place where static electricity is a problem.
Otherwise it can cause failure or malfunction of the system.
- If using the product in an interlocking circuit:
 - Provide a double interlocking system, for example a mechanical system
 - Check the product regularly for proper operationOtherwise malfunction can result, causing an accident.
- The following instructions must be followed during maintenance:
 - Turn off the power supply
 - Stop the air supply, exhaust the residual pressure and verify that the air is released before performing maintenance workOtherwise an injury can result.

Caution

- Do not touch the terminals and connectors while the power is on.
Otherwise electric shock, malfunction or damage to the product can result.
- After maintenance is complete, perform appropriate functional inspections and leak tests.
Stop operation if the equipment does not function properly or there is a leakage of fluid.
When leakage occurs from parts other than the piping, the product might be faulty.
Disconnect the power supply and stop the fluid supply.
Do not apply fluid under leaking conditions.
Safety cannot be assured in the case of unexpected malfunction.

■ NOTE

- Follow the instructions given below when designing, selecting and handling the product.
 - The instructions on design and selection (installation, wiring, environment, adjustment, operation, maintenance, etc.) described below must also be followed.
 - * Product specifications
 - The direct current power supply used should be UL approved as follows.
Circuit (Class 2) of maximum 30 Vrms (42.4 V peak) or less, with UL1310 Class 2 power supply unit or UL1585 Class 2 transformer.
 - The product is a UL approved product only if it has a  mark on the body.
 - Use the specified voltage.
Otherwise failure or malfunction can result.
Insufficient supply voltage may not drive a load due to a voltage drop inside the product.
Verify the operating voltage of the load before use.
 - Do not exceed the specified maximum allowable load.
Otherwise it can cause damage or shorten the lifetime of the product.
 - Data stored by the product is not deleted, even if the power supply is cut off.
(Writing time: 1000000 cycles)
 - The applicable fluids are dry air and Nitrogen.
The fluid temperature range is 0 to 50 °C.
 - Before designing piping confirm the pressure loss at the sensor from the pressure loss graph.
 - For the details of compressed air quality, refer to ISO 8573-1, 1.1.2 to 1.6.2.
 - Use the specified measurement flow rate and operating pressure.
Otherwise it can cause damage to the product or inability to measure correctly.
 - Reserve a space for maintenance.
Allow sufficient space for maintenance when designing the system.

●Product handling

*Installation

- Tighten to the specified tightening torque.

If the tightening torque is exceeded the mounting screws, the product may be damaged.

If the tightening torque is insufficient, the product may be displaced and the mounting screws may come loose.

- Ensure that the FG terminal is connected to ground when using a commercially available switch-mode power supply.
- Do not drop, hit or apply excessive shock to the product.
Otherwise damage to the internal parts can result, causing malfunction.
- Do not pull the lead wire forcefully, or lift the product by the lead wire. (Tensile force 49 N or less)
Hold the product body when handling, to prevent damage, failure or malfunction.
- For piping of the product, hold the piping with a wrench on the metal part of the product.
Holding other parts with a wrench leads to may damage the product.
- Any dust left in the piping should be flushed out by air blow before connecting the piping to the product.
Otherwise damage or malfunction can result.
- Refer to the flow direction of the fluid indicated on the product label for installation and piping.
- Do not mount the body with the bottom facing upwards.
Retention of air can cause inability to measure accurately.
- Do not insert metal wires or other foreign matter into the piping port.
This can damage the sensor causing failure or malfunction.
- Never mount a product in a location that will be used as a foothold.
The product may be damaged if excessive force is applied by stepping or climbing onto it.
- Do not apply excessive rotational force to the monitor.
The monitor with integrated display can be rotated.
It can be positioned at 45 ° and 90 ° intervals, clockwise and anti-clockwise.
Rotating the display with excessive force will damage the end stop.
- If there is a risk of foreign matter entering the fluid, install and pipe a filter or the mist separator at the inlet to avoid failure and malfunction.
Otherwise failure or malfunction can result, and it can cause inability to measure accurately.
It is possible to satisfy the air quality class indicated in the specification using the pneumatic circuit below.

Recommended pneumatic circuit example (Compressed air)

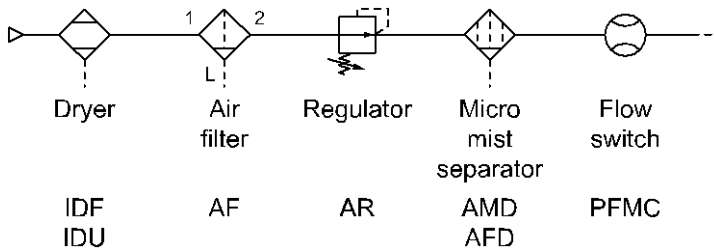

*Wiring

- Do not pull the lead wires. In particular, never lift a product equipped with fitting and piping by holding the lead wires.
Otherwise damage to the internal parts can result, causing malfunction or disconnection of the connector.
- Avoid repeatedly bending or stretching the lead wire, or placing heavy loads on it.
Repeated bending stress or tensile stress can cause damage to the sheath, or breakage of the wires.
If the lead wire can move, fix it near the body of the product.
The recommended bend radius of the lead wire is 6 times the outside diameter of the sheath, or 33 times the outside diameter of the wire insulation material, whichever is larger.
Replace any damaged lead wire with a new one.
- Wire correctly.
Incorrect wiring can damage the product.
- Do not perform wiring while the power is on.
Otherwise damage to the internal parts can result, causing malfunction.
- Do not route wires and cables together with power or high voltage cables.
Otherwise the product can malfunction due to interference or noise and surge voltage from power and high voltage cables.
- Confirm proper insulation of wiring.
Poor insulation (interference from another circuit, poor insulation between terminals, etc.) can lead to excess voltage or current being applied to the product, causing damage.
- Keep wiring as short as possible to prevent interference from electromagnetic noise and surge voltage.
Do not use a cable longer than 20 m.
Wire the DC (-) line (blue) as close as possible to the power supply.
- When analogue output is used, install a noise filter (line noise filter, ferrite element, etc.) between the switch-mode power supply and this product.

*Environment

- Do not use the product in an environment that is constantly exposed to the splash of water.
Otherwise failure or malfunction can result. Take measures such as using a cover.
- Do not use the product in an environment where corrosive gases or fluids could be splashed.
Otherwise damage to the product and malfunction can result.
- Do not use in a place where the product could be splashed by oil or chemicals.
If the product is to be used in an environment containing oils or chemicals such as coolant or cleaning solvent, even for a short time, it may be adversely affected (damage, malfunction, or hardening of the lead wires).
- Do not use the product in an area where electrical surges are generated.
If there is equipment generates large electrical surges (solenoid type lifter, high frequency induction furnace, motor, etc.) close to the product, damage or failure of the internal circuit may occur. Take measures against the surge sources, and prevent the wires from coming into close contact.
- Do not use a load which generates a surge voltage.
When a surge-generating load such as a relay or solenoid is driven directly, use a product with a built-in surge absorbing element.
- The product is CE marked, but not immune to lightning strikes. Take measures against lightning strikes in the system.
- Do not use the product in areas that are exposed to vibration or impact.
Otherwise failure or malfunction can result.
- Do not use the product in the presence of a magnetic field.
This may lead to the malfunction of the product.
- Prevent foreign matter such as wire debris from entering the product.
Otherwise failure or malfunction can result.
- Do not use the product in areas subject to large temperature cycle.
Heating/cooling cycles other than ordinary changes in temperature can adversely affect the internal structure of the product.
- Do not expose the product to direct sunlight.
If using in a location directly exposed to sunlight, use a suitable protective cover.
Otherwise failure or malfunction can result.
- Keep within the operating temperatures range.
The operating temperature range is 0 to 50 °C.
Operation below the minimum temperature limit may cause damage or operation failure due to frozen moisture in the fluid or air.
Protection against freezing is necessary.
An air dryer is recommended for elimination of drainage and water.
Avoid sudden temperature changes even within the specified temperature range.
- Do not operate close to a heat source, or in a location exposed to radiant heat.
Otherwise malfunction can result.

*Adjustment and Operation

- Connect load before turning on the power.

- Do not short-circuit the load.

Although an error is displayed when the product load is short circuited, excess current may cause damage to the product.

- Do not press the setting buttons with a sharp pointed object.

This may damage the setting buttons.

- Supply the power when there is no flow.

- If using the product to detect very small flow rates, warm up the product for 10 to 15 minutes first.

There will be a drift on the display or the analogue output of approximate ± 2 to 3% immediately after the power supply is turn on, within 10 minutes.

- The output is off for 3 seconds after power is supplied.

- Use settings suitable for the operating conditions.

Incorrect settings can cause operational failure.

- During the initial setting and any subsequent flow rate setting, the product will switch the output according to the existing settings until the changes are complete.

Confirm the output has no adverse effect on machinery and equipment before setting.

Stop the control system before setting if necessary.

- Do not touch the LCD display during operation.

The display can vary due to static electricity.

*Maintenance

- Perform regular maintenance and inspections.

There is a risk of unexpected malfunction of components due to the malfunction of equipment and machinery.

- Turn off the power supply, stop the supplied air, exhaust the residual pressure and verify the release of air before performing maintenance.

There is a risk of unexpected malfunction.

- Perform drainage regularly.

If condensate enters the outside, it can cause failure of other pneumatic equipment.

- Do not use solvents such as benzene, thinner etc. to clean the product.

They could damage the surface of the body and erase the markings on the body.

Use a soft cloth to remove stains.

For heavy stains, use a cloth lightly dampened with diluted neutral detergent, then wipe up any residue with a dry cloth.

Model Indication and How to Order

PFMC 7 - - -

Type

Symbol	Type
7	Integrated display type

Rated flow range

Symbol	Content
501	0.5 to 4 L/min
102	2 to 16 L/min
202	5 to 40 L/min

Thread type

Symbol	Content
Nil	Rc
N	NPT
F	G *1

*1: ISO228 compliant.

Port size

Symbol	Size	Rated flow range		
		501	102	202
04	1/2	●	●	-
06	3/4	-	-	●

Calibration certificate

Symbol	Content
Nil	Without calibration certificate
A	With calibration certificate *9

*9: Made to Order.
Certificate in both Japanese and English.

Option 2

Symbol	Content
Nil	No bracket
R	With bracket *8

*8: Each accessory is not assembled with the product, but shipped together.

Unit specification

Symbol	Content
Nil	Unit selection function *6
M	SI unit only *7

*6: Since the unit for Japan is fixed to SI due to new measurement law, this option is for overseas.

*7: Fixed unit Instantaneous flow: L/min, Accumulated flow: L

Option 1

Symbol	Content
Nil	With lead wire with M8 connector (3 m) *5
N	No lead wire
Q	With M12-M8 conversion lead wire (0.1 m)

*5: Each accessory is not assembled with the product, but shipped together.

Output specification

Symbol	OUT1	OUT2 *2	Applicable monitor
L	IO-Link/Switch output (N/P)	-	-
L2	IO-Link/Switch output (N/P)	Switch output (N/P) ↔ External input *3	-
L3	IO-Link/Switch output (N/P)	Analogue voltage output *4	PFG300 series
L4	IO-Link/Switch output (N/P)	Analogue current output	PFG310 series

*2: Switch output (analogue output) or external input can be selected by pressing the buttons.
Analogue output is set as the default setting.

Output option symbol "L" is not available because the OUT2 terminal is not connected.

*3: Accumulated value external reset or peak/bottom reset can be selected.

*4: 1 to 5 V or 0 to 10 V can be selected by pressing the buttons.
The default setting is 1 to 5 V.

Accessories/Part numbers

If an accessory is required, order using the following part number.

Part number	Description	Note
ZS-40-A	Lead wire with M8 connector	Length: 3 m
ZS-42-A	Bracket	With mounting screws for PFMC7501/7102 (M3 x 5, 2 pcs.)
ZS-42-B	Bracket	With mounting screws for PFMC7202 (M3 x 5, 2 pcs.)
ZS-40-M12M8-A	M12-M8 conversion lead wire	Length: 0.1 m

Summary of Product parts

Body

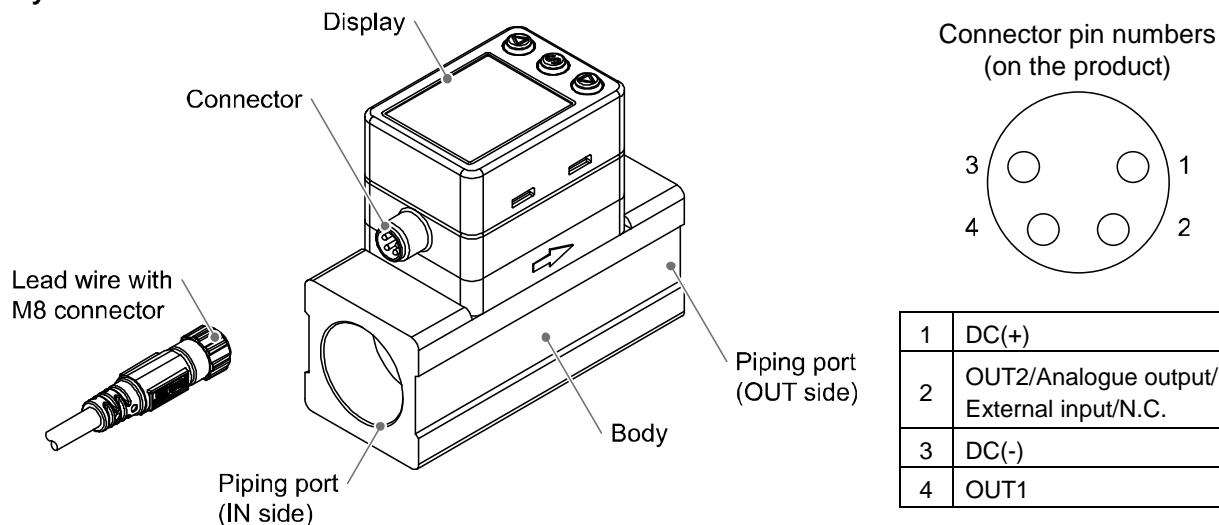

Name	Description
Display *	See below.
Connector	M8 connector for electrical connections.
Lead wire with M8 connector	Lead wire for power supply and outputs.
Piping port	For piping connections. Connected to the fluid inlet at IN and to the fluid outlet at OUT.
Body	The body of the product.



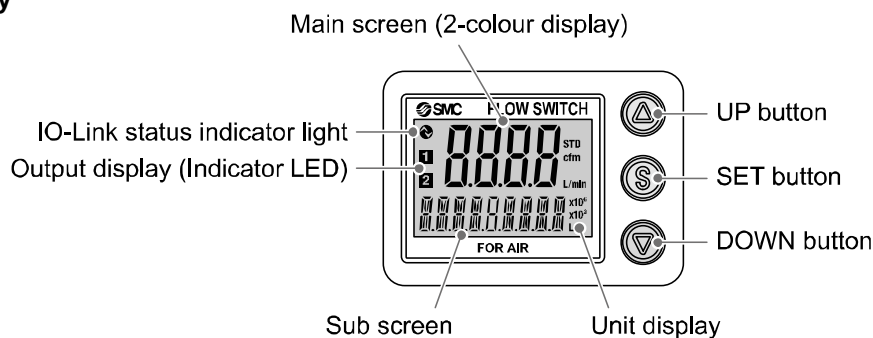

*: A protective tape is affixed to the display. Please remove it before use.

Display



Element	Description
Main screen (2-colour display)	Displays the flow, the status of setting mode and error code.
Sub screen	Displays the accumulated flow, set value, peak/bottom value and line names. In the measurement mode, the set status is displayed.
Output display (Indicator LED)	Displays the output status of OUT1 and OUT2. When ON: Orange LED is ON.
Unit display	Displays the unit selected.
UP button	Selects a mode and the display shown at the sub screen, and increases the ON/OFF set values.
SET button	Press this button to select mode and to confirm a set value.
DOWN button	Selects a mode and the display shown at the sub screen, and decreases the ON/OFF set values.
IO-Link status indicator light	LED is ON when OUT1 is used in IO-Link mode. (LED is OFF in SIO mode)

●IO-Link indicator light operation and display

Communication with master	IO-Link status indicator light	Status			Sub screen display ^{*1}	Content
						
Yes		IO-Link mode	Correct	Operate	ModE oPE	Normal communication status (Reading of measurement value)
				Start up	ModE St rE	When communication starts up.
				Preoperate	ModE PrE	
			Abnormal	Version does not match	Er 15 V 1.0	Version of master and IO-Link does not match ^{*2}
				Lock	ModE LoL	Back-up and re-store required due to data storage lock
No			Communication shut-off	ModE St rE ModE PrE ModE oPE	Correct communication was not received for 1 second or more.	
			SIO mode	ModE S IO	General switch output	

LCD display: "O" OFF, "" Flashing, "" ON

*1: "ModE - - -" is displayed when selecting the modes on the sub screen.

*2: When the product is connected to the master with version "V1.0", error Er15 is generated.

■ Definition and terminology

	Terminology	Definition
A	Accumulated flow	The total amount of fluid that has passed through the device. If an instantaneous flow of 10 L/min continues for 5 minutes, the accumulated flow will be $5 \times 10 = 50$ L.
	Accumulated flow external reset	A function to reset the accumulated flow to "0" when an external signal is input.
	Accumulated pulse output	A type of output where a pulse is generated every time a predefined accumulated flow passes. It is possible to calculate the total accumulated flow by counting the pulses.
	Accumulated value hold	A function to store the accumulated flow value in the internal memory. The flow value will be stored at a set time interval of either 2 or 5 minutes. When the power supply is turned on, the stored accumulated flow value will be displayed and accumulated flow will continue from that point.
	Analogue output	A type of variable output that has a value proportional to the measured quantity. When the analogue output is in the range of 1 to 5 V or 4 to 20 mA, it will vary continuously, following the change of flow.
C	Chattering	The problem of the switch output turning ON and OFF repeatedly around the set value at high frequency due to the effect of pulsation.
D	Delay time	The setting time from when the flow applied to the flow switch reaches the set value, to when the ON-OFF output actually begins working. Delay time setting can prevent the output from chattering. The response time indicates when the set value is 90% in relation to the step input.
	Display flow range	The range which can be displayed by the product with a digital display.
	Digital filter	Function to add digital filtering to the fluctuation of flow value. Smooth the fluctuation of displayed value for sharp start up or fall of the flow. When the function is valid, digital filtering is reflected to the ON/OFF of the switch output. Output chattering or flicker in the measurement mode display can be reduced by setting the digital filter.
F	F.S. (Full span, Full scale)	Stands for "full span" or "full scale", and indicates varied analogue output range at rated value. For example, when analogue output is 1 to 5 V, $F.S. = 5[V] - 1[V] = 4[V]$, (ref. $1\%F.S. = 4[V] \times 1\% = 0.04[V]$) The maximum measuring range or change in analogue output over the maximum measurement range.
H	Hysteresis	The difference between ON and OFF points used to prevent chattering. Hysteresis can be effective in avoiding the effects of pulsation.
	Hysteresis mode	Mode where the switch output will turn ON when the flow is greater than the set value, and will turn OFF when the flow falls below the set value by the amount of hysteresis or more.
I	Instantaneous flow	The volume of flow per unit of time. If it is 10 L/min, there is a flow of 10 L passing through the device in 1 minute.
	Internal voltage drop	The voltage drop across the product (and therefore not applied to the load), when the switch output is ON. The voltage drop will vary with load current, and ideally should be 0 V.
K	Key-lock function	A function that locks the set buttons so that no accidental setting changes can be made.

	Terminology	Definition
M	Minimum setting unit	The resolution of set and display values. If the minimum setting unit is 1 L/min, the flow can be displayed in 1 L/min units, i.e. 10, 11, 12.
N	Normal condition (NOR)	Reference condition for volumetric flow: 101.3 kPa, 0 °C The flow measurement which is converted at normal atmospheric pressure conditions at 0 °C.
O	Operating fluid temperature	The fluid temperature range within which the product will meet all published specifications.
	Operating humidity range	The ambient humidity range within which the product will meet all published specifications.
	Operating pressure range	The pressure range within which the product will meet all published specifications.
	Operating temperature range	The ambient temperature range within which the product will meet all published specifications.
P	Part in contact with fluid	A part that comes into physical contact with the fluid.
	Pressure characteristics	The amount of variation in the analogue output or display value when the supply pressure is changed.
	Proof pressure	The pressure beyond which the product will be damaged.
R	Rated flow range	The flow range within which the product will meet all published specifications.
	Repeatability	Reproducibility of the display or analogue output value, when the flow is repeatedly changing.
	Response time (analogue output)	The time from when the flow is applied as a step input (when the flow rate changes from 0% to 100% instantaneously) until the switch output turns ON (OFF) at 90% of the rated flow rate.
	Ripple	Indicates pulsation.
S	Set flow range	The range of ON/OFF threshold values that can be set for products with a switch output.
	Standard condition (ANR)	Reference condition for volumetric flow: 101.3 kPa, 20 °C, 65%RH The flow measurement which is converted at normal atmospheric pressure conditions at 20 °C, 65%R.H.
	Switch output	An output type that has only 2 conditions, ON or OFF. In the ON condition an indicator LED will turn on, and any connected load will be powered. In the OFF condition, there will be no indicator LED and no power is supplied to the load.
T	Temperature characteristic	The amount of variation in the analogue output or display value when the ambient temperature is changed.
U	Unit selection function	Function to change the unit in which the value of flow is displayed. Only a product with this function can change the unit. A product with unit selection function cannot be purchased if it is used within Japan. Flow is indicated only by SI units in Japan.
W	Window comparator mode	An operating mode in which the switch output is turned on or off depending on whether the flow is within the range of 2 set values.

Mounting and Installation

Mounting

- Never mount the product in a place where it will be used as a mechanical support.
- Mount the product so that the fluid flows in the direction indicated by the arrow on the side of the body.
- The monitor with integrated display can be rotated. It can be positioned at 45 ° and 90 ° intervals, clockwise and anti-clockwise. Rotating the display with excessive force will damage the end stop.

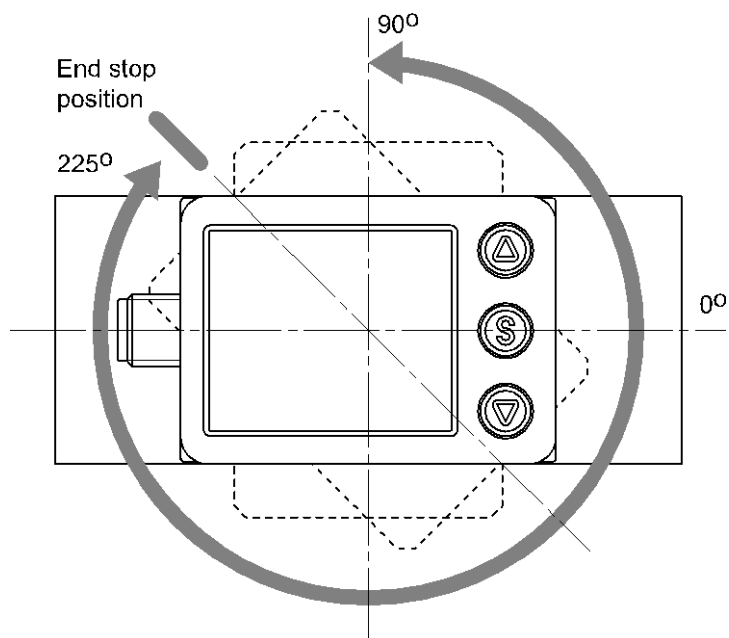

■ Installation

Bracket mounting

- Mount the bracket to the product using the mounting screws (2 pcs.).
- Fasten the bracket mounting screws to a torque of 0.5 to 0.7 Nm.

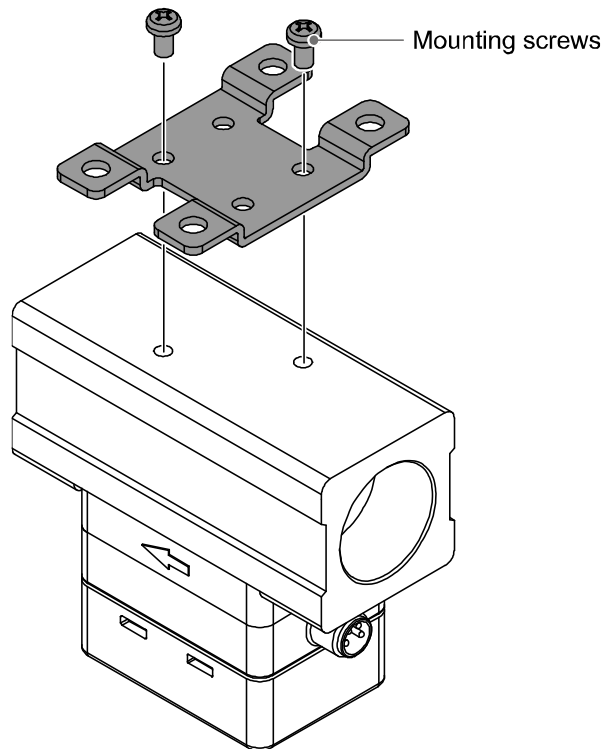

- Mount the product with bracket using M4 screws (4 pcs.) or equivalent.
- Screw is prepared by customer.
- Refer to the dimension drawing (page 95) for the bracket thickness and mounting hole dimensions.

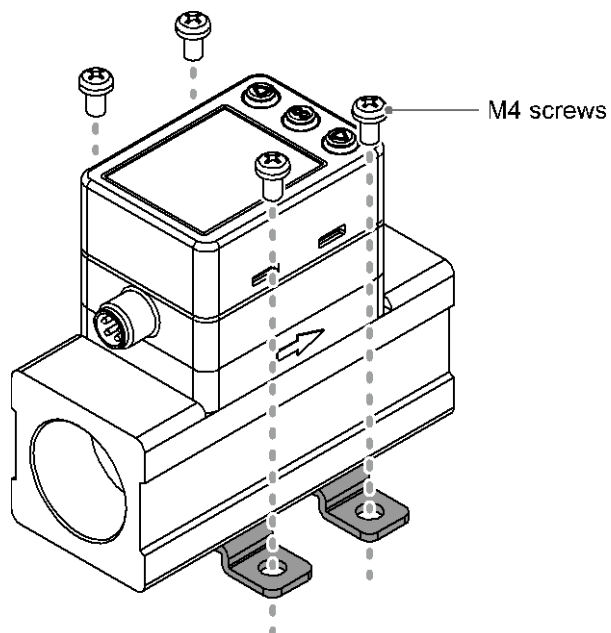

Direct mounting

- For direct mounting use M3 screws (2 pcs.) or equivalent.
- Screws are prepared by customer.
- Refer to the dimension drawing (page 95) for the diameter and depth of the mounting screw holes.
- Tightening torque is 0.5 to 0.7 Nm.

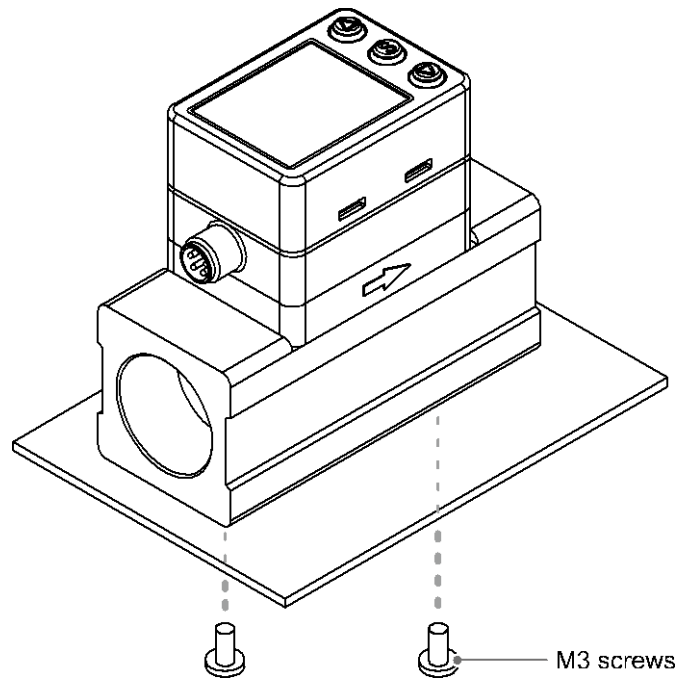

■ Piping

- Never mount the product upside down.
- The straight piping length shall be 8 cm or longer.
Otherwise, if a straight section of piping is not installed, the accuracy varies by approximately $\pm 2\%$ F.S. Refer to the straight inlet piping length and accuracy graph (page 94).
- Avoid sudden changes in the piping size on the IN side of the product.
- Do not release the OUT side piping port of the product directly to the atmosphere without the piping connected.
If the product is used with the piping port released to atmosphere, the accuracy may vary.

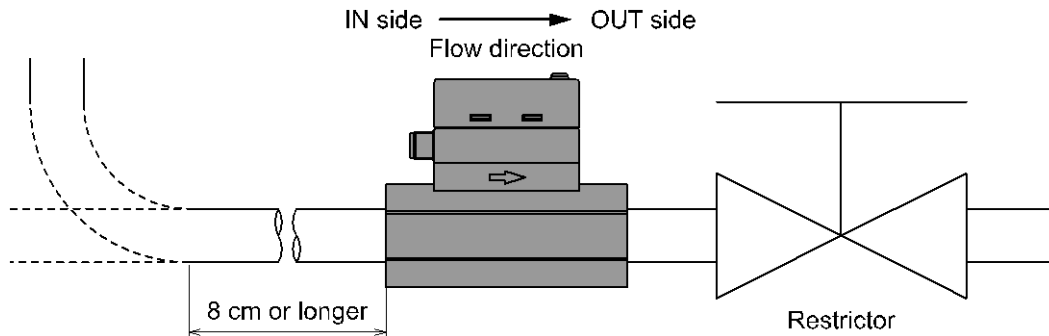

Piping for the metal body

- Tighten to the specified torque. Refer to the table below for the required torque values.
- If the tightening torque is exceeded, the product can be broken.
If the tightening torque is insufficient, the fitting may become loose.
- Avoid any sealing tape getting inside the flow path.
- Ensure there is no leakage after piping.
- When mounting the fitting, a spanner should be used on the metal body of the fitting only.
Holding other parts of the product with a spanner may damage the product.
Specifically, make sure that the spanner does not damage the connector.

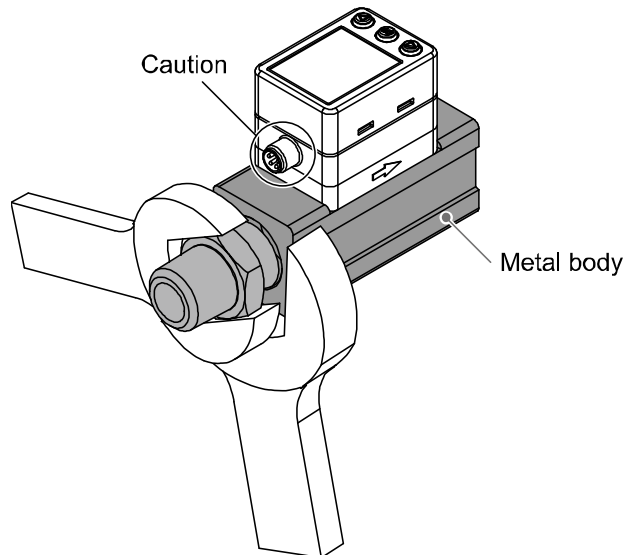

Nominal thread size	Required torque
Rc1/2, NPT1/2, Rc3/4, NPT3/4	28 to 30 Nm

Piping port size	Width across flats of attachment
1/2	30 mm
3/4	35 mm

Piping for the One-touch fitting

- For the one-touch fitting, use tubing with a tube inside diameter of 9 mm or more.
Accuracy can vary approximately $\pm 2\%$ F.S. when such tubing is not used.

■Wiring

Connection

- Connections should only be made with the power supply turned off.
- Use a separate route for the product wiring and any power or high voltage wiring. Otherwise, malfunction may result due to noise.
- Ensure that the FG terminal is connected to ground when using a commercially available switch-mode power supply. When a switch-mode power supply is connected to the product, switching noise will be superimposed and the product specification can no longer be met. This can be prevented by inserting a noise filter, such as a line noise filter and ferrite core, between the switch-mode power supply and the product or by using a series power supply instead of a switch-mode power supply.

Connecting/Disconnecting

- Align the lead wire connector with the connector key groove, and insert it straight in. When the knurled part is fully tightened. Check that the connection is not loose.
- When removing the connector, unlock the knurled part and pull out the connector straight.

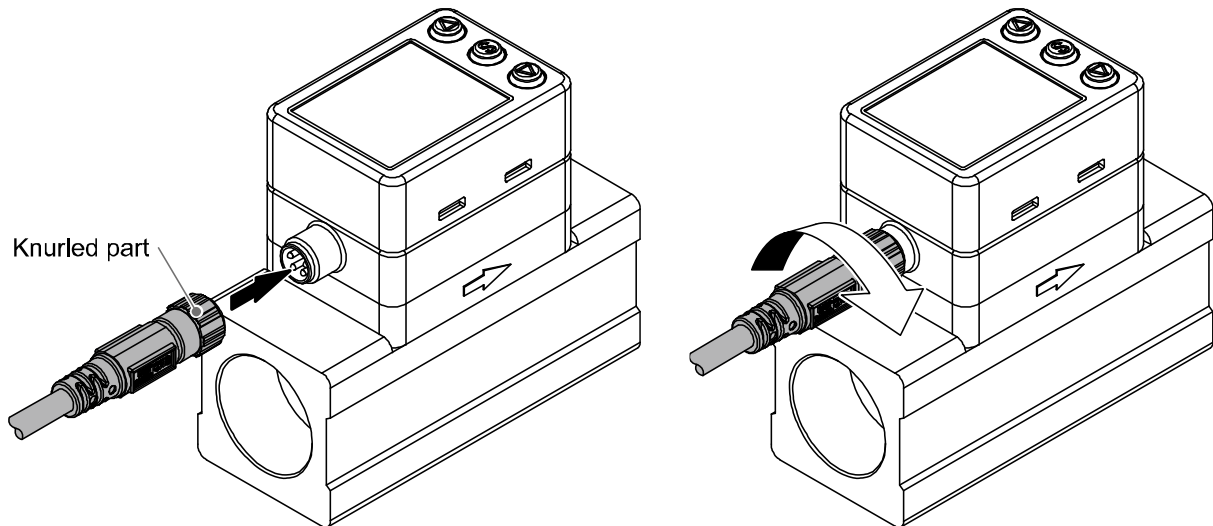

Connector pin numbers (lead wire)

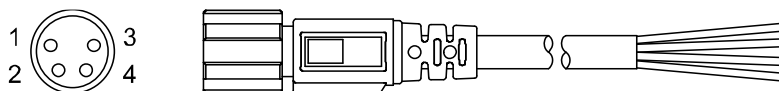

Used as switch output device

No.	Name	Lead wire colour	Function
1	DC(+)	Brown	12 to 24 VDC
2	N.C./OUT2	White	Not connected/Switch output 2 (SIO)/Analogue output/External input
3	DC(-)	Blue	0 V
4	OUT1	Black	Switch output 1

Used as IO-Link device

No.	Name	Lead wire colour	Function
1	L+	Brown	18 to 30 VDC
2	N.C./OUT2	White	Not connected/Switch output 2 (SIO)/Analogue output/External input
3	L-	Blue	0 V
4	C/Q	Black	Communication data (IO-Link)/Switch output 1 (SIO)

*: When using the lead wire with M8 connector included with the PFM7 series.

Internal circuit and wiring examples

PFMC7###-##-L#-###

NPN type

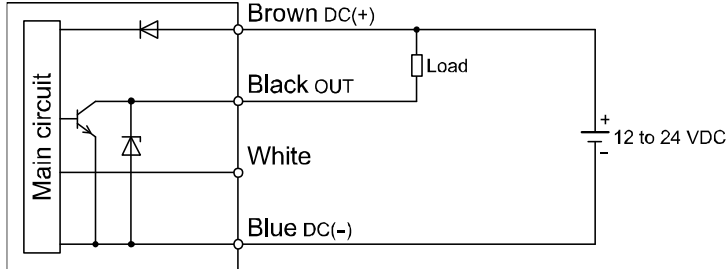

Maximum applied voltage: 28 V

Maximum load current: 80 mA

Internal voltage drop: 1.5 V or less

PFMC7###-##-L2#-###

NPN type

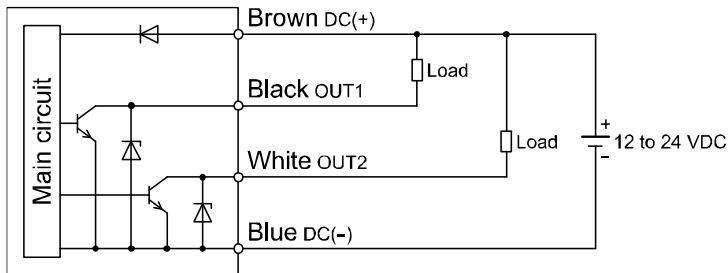

Maximum applied voltage: 28 V

Maximum load current: 80 mA

Internal voltage drop: 1.5 V or less

PFMC7###-##-L3/L4#-###
NPN type

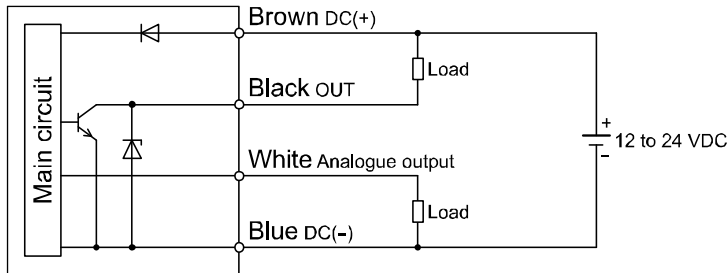

Maximum applied voltage: 28 V
 Maximum load current: 80 mA
 Internal voltage drop: 1.5 V or less
 L3: Analogue output: 1 to 5 V or 0 to 10 V
 Output impedance: 1 k Ω
 L4: Analogue output: 4 to 20 mA
 Maximum load impedance: 600 Ω
 Minimum load impedance: 50 Ω

PFMC7###-##-L2#-###
NPN + External input type

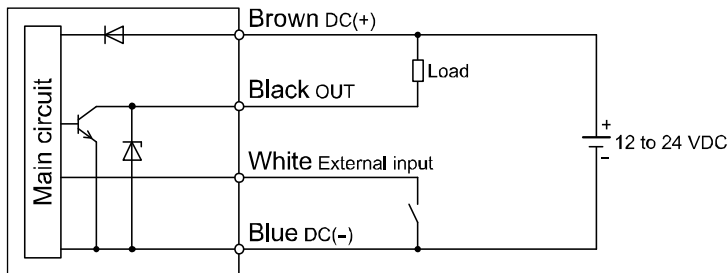

Maximum applied voltage: 28 V
 Maximum load current: 80 mA
 Internal voltage drop: 1.5 V or less
 External input: Input voltage 0.4 V or less (reed or solid state input) for 30 msec. or longer

PFMC7###-##-L#-###
PNP type

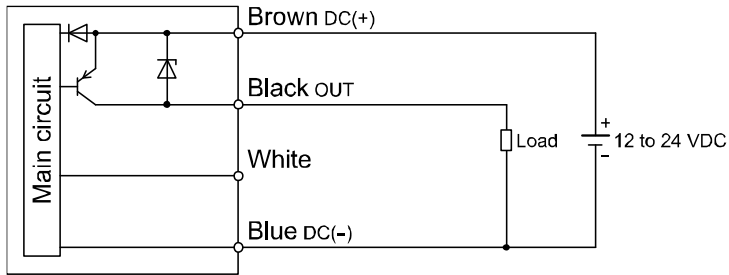

Maximum load current: 80 mA
Internal voltage drop: 1.5 V or less

PFMC7###-##-L2#-###
PNP type

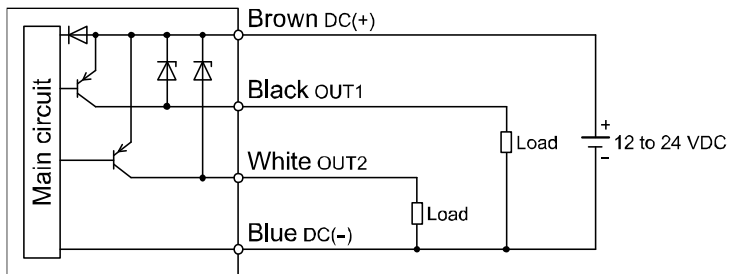

Maximum load current: 80 mA
Internal voltage drop: 1.5 V or less

PFMC7###-##-L3/L4#-###
PNP type

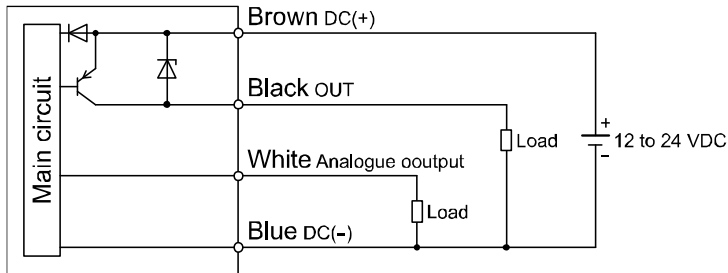

Maximum load current: 80 mA
 Internal voltage drop: 1.5 V or less
 L3: Analogue output: 1 to 5 V or 0 to 10 V
 Output impedance: 1 k Ω
 L4: Analogue output: 4 to 20 mA
 Maximum load impedance: 600 Ω
 Minimum load impedance: 50 Ω

PFMC7###-##-L2#-###
PNP + External input type

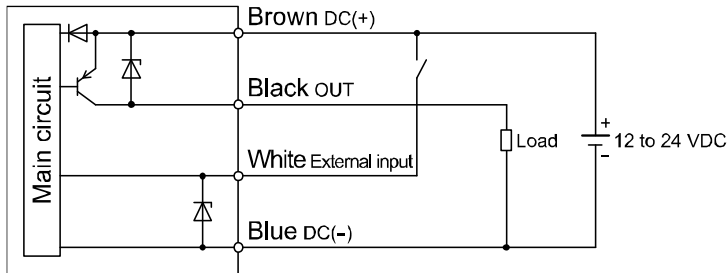

Maximum load current: 80 mA
 Internal voltage drop: 1.5 V or less
 External input: Input voltage DC(+) -1 V or longer (reed or solid state input) for 30 msec. or longer

Used as IO-Link device

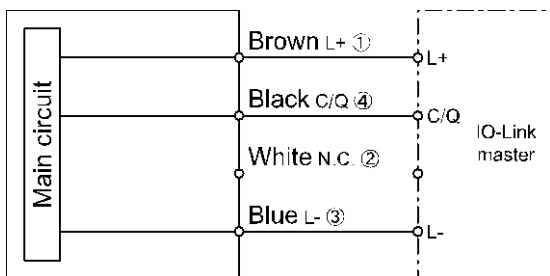

*: Numbers in the figures show the connector pin layout.

Example of wiring for accumulated pulse output

NPN output type

PFMC7###-##-L#-###

NPN 2 outputs + Analogue output type

PFMC7###-##-L2#-###

NPN (1 output) + Analogue output type

PFMC7###-##-L3/L4#-###

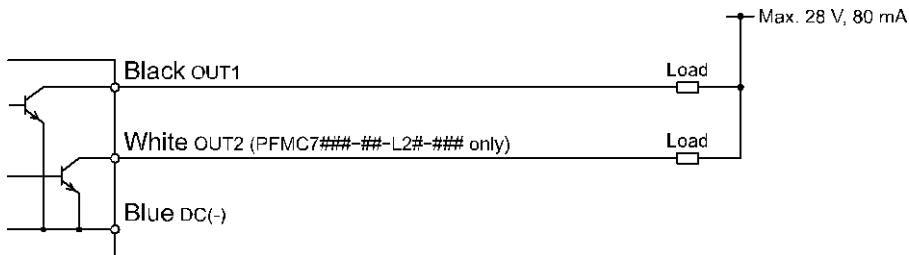

PNP output type

PFMC7###-##-B#-###

PNP 2 outputs

PFMC7###-##-L2#-###

PNP (1 output) + Analogue output type

PFMC7###-##-L3/L4#-###

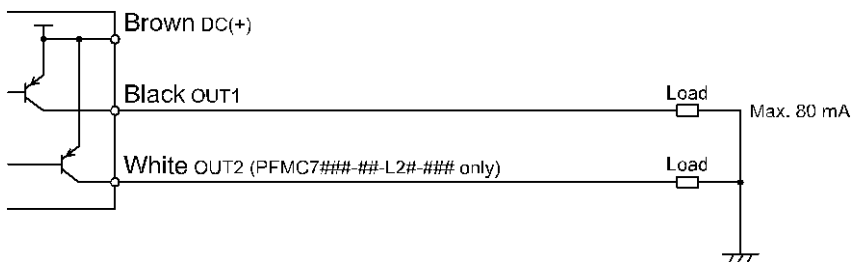

Outline of Settings [Measurement mode]

Power is supplied



The output will not operate for 3 seconds after supplying power.
The identification code of the product is displayed.



[Measurement mode]

Measurement mode is the condition where the flow is detected and displayed, and the switch function is operating.
This is the basic mode; other modes should be selected for set-point changes and other function settings.

Sub display

In measurement mode, the sub display can be temporarily changed (for 30 seconds) by pressing the UP or DOWN button.

After 30 seconds, it will automatically reset to the display selected in [F10]. (Refer to page 49)
(Example shown is for 500 L/min type)

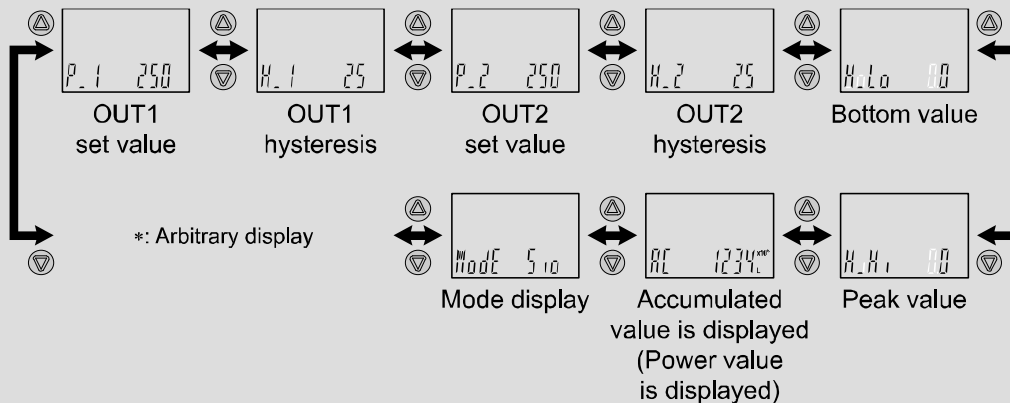

*: An arbitrary display can be added to the sub display by setting in [F10].
If the sub display is switched during the arbitrary display, the display will return to the arbitrary display 30 seconds later.
(The default setting does not include arbitrary display).

Press the SET button once.

Press the SET button for 2 seconds or longer.



Flow Setting
(set value only)
of OUT1 - OUT2
[3 step setting mode]
(Refer to page 27.)

Function Setting
[Function selection mode]
(Refer to page 30.)

Other Functions
(Refer to page 68.)

- *: The outputs will continue to operate during setting.
- *: If a button operation is not performed for 30 seconds during the setting, the display will flash (This is to prevent the setting from remaining incomplete if, for instance, an operator were to leave during setting).
- *: 3 step setting mode and Function selection mode are reflected on each other.

Flow Setting (set value only) of OUT1 - OUT2 [3 step setting mode]

3 step setting mode

In this mode, only the set values can be input, in just 3 steps.

Use this mode if the product is to be used straight away, after changing only the set values.

■ Default settings

When the flow exceeds the set value [P_1], the switch will be turned ON.

When the flow falls below the set value by the amount of hysteresis [H_1] or more, the switch will turn OFF.

If the operation shown in the diagram below is acceptable, then keep these settings.

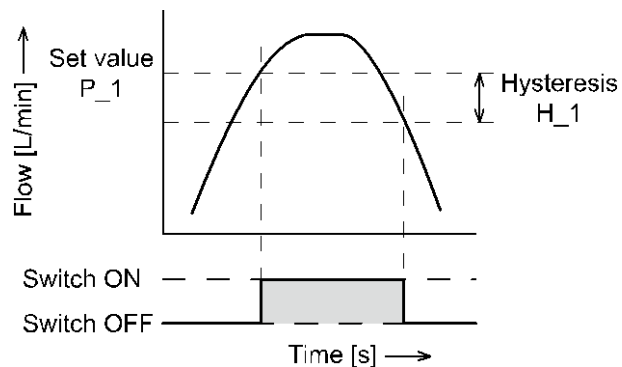

●PFMC7501

Item	Default settings
[P_1] Set value of OUT1	250 L/min
[H_1] Hysteresis of OUT1	25 L/min
[P_2] Set value of OUT2 *	250 L/min
[H_2] Hysteresis of OUT2 *□	25 L/min

●PFMC7102

Item	Default settings
[P_1] Set value of OUT1	500 L/min
[H_1] Hysteresis of OUT1	50 L/min
[P_2] Set value of OUT2 *	500 L/min
[H_2] Hysteresis of OUT2 *	50 L/min

●PFMC7202

Item	Default settings
[P_1] Set value of OUT1	1000 L/min
[H_1] Hysteresis of OUT1	100 L/min
[P_2] Set value of OUT2 *	1000 L/min
[H_2] Hysteresis of OUT2 *	100 L/min

*: Only available for models with switch outputs for both OUT1 and OUT2.

*: For input of hysteresis, perform the settings referring to [F 1] Setting of OUT1 (page 35 to) and [F 2] Setting of OUT2 (page 42 to).

<Operation>

1. Press the SET button in measurement mode to display set values.
(The item to be changed is displayed on the sub display)
Set value on the right side of the sub screen flashes.

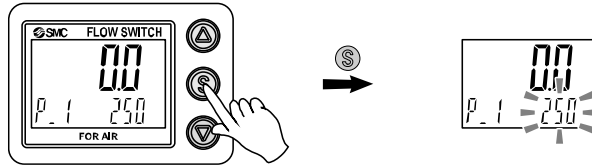

2. Press the UP or DOWN button to change the set value.
The UP button is to increase and the DOWN button is to decrease the set value.

- Press the UP button once to increase by one digit, or press and hold to continuously increase.

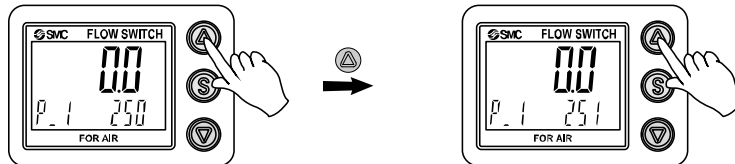

- Press the DOWN button once to decrease by one digit, or press and hold to continuously decrease.

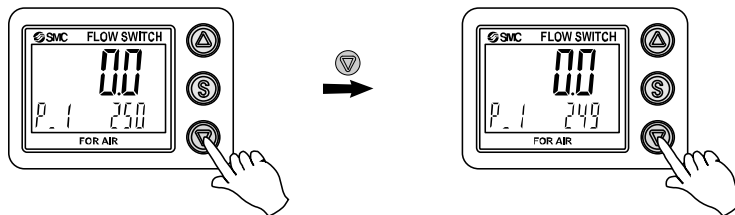

3. Press the SET button to finish the setting.

- *: The above example is for the 500 L/min type.
- *: For models with switch outputs for both OUT1 and OUT2, [P_2] or [n_2] will be displayed too. Set as above.
- *: For input of hysteresis, perform the settings referring to [F 1] Setting of OUT1 (page 35 to) and [F 2] Setting of OUT2 (page 42 to).
- *: When a mode other than hysteresis mode is selected, "Input of set value" of page 36 is displayed.
- *: Note that the set value and hysteresis are limited by each other.
- *: For more detailed settings, set each function in function selection mode (page 30).

Simple Setting Mode

<Operation>

[Simple setting mode (hysteresis mode)]

In the simple setting mode, the set value and hysteresis can be changed while checking the current flow value (main screen).

- (1) Press and hold the SET button for 1 to 3 seconds in measurement mode. [SEt] is displayed on the main screen. When the button is released while in the [SEt] display, the current flow value is displayed on the main screen, [P_1] or [n_1] is displayed on the sub screen (left side), and the set value is displayed on the sub screen (right side) (Flashing).

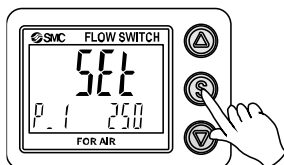

- (2) Change the set value with the UP or DOWN button, and press the SET button to set the value. Then, the setting moves to hysteresis setting. (The snap shot function can be used. (Refer to page 68))

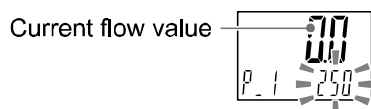

- (3) Change the set value with the UP or DOWN button, and press the SET button to set the value. Then, the setting moves to the setting of OUT2. (The snap shot function can be used. (Refer to page 68))

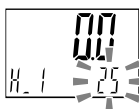

- (4) Press the SET button for less than 2 seconds to complete the OUT1 setting. [P_2] or [n_2] is displayed on the sub screen (left side). Continue with setting the OUT2. Press and hold the SET button for 2 seconds or longer to complete the setting. The product will return to measurement mode.

*1: Selected items (1) to (3) become valid after pressing the SET button.

*2: After enabling the setting by pressing the SET button, it is possible to return to measurement mode by pressing the SET button for 2 seconds or longer.

*3: When the output mode (refer to page 37) is set to error output or output OFF, the simple setting mode cannot be used. (The setting changes to measurement mode by releasing the button when [SEt] is displayed.)

Function Setting [Function selection mode]

Function selection mode

In this mode, each function setting can be changed separately.

In measurement mode, press the SET button between 3 and 5 seconds, to display [F 0].

Press the UP or DOWN button to select the function to be changed.

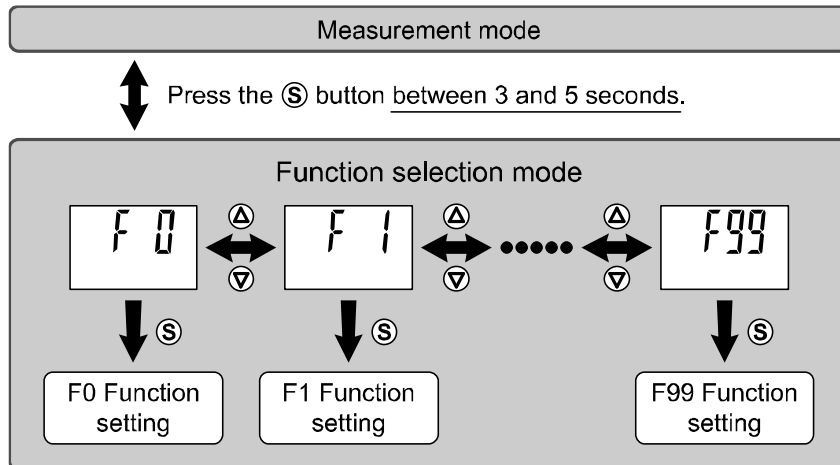

Press the SET button for 2 seconds or longer in function selection mode to return to measurement mode.

■ Default settings

Item (Main display)		Default settings (Sub display)	Page
[F 0]	[rEF] Reference condition	[Std] Standard condition	Page 32
	[Unit] Unit selection function *1	[L] L/min	
	[NorP] SW output PNP/NPN setting	[PnP] PNP output	
	[i_o] SW/external input setting *2	[oUt] SW output	
[F 1]	[oUt1] Output mode of OUT1	[HYS] Hysteresis mode	Page 35
	[1ot] Switch operation of OUT1	[1_P] Normal output	
	[P_1] Set value of OUT1	50% of maximums rated flow range [250] 250 L/min (500 L type) [500] 500 L/min (1000 L type) [1000] 1000 L/min (2000 L type)	
	[H_1] Hysteresis of OUT1	5% of maximums rated flow range [25] 25 L/min (500 L type) [50] 50 L/min (1000 L type) [100] 100 L/min (2000 L type)	
	[dtH1] ON delay time	[0.00] 0.00 s	
	[dtL1] OFF delay time	[0.00] 0.00 s	
	[CoL] Display colour of OUT1	[1SoG] Green when ON, Red when OFF (OUT1)	
[F 2] *3	[oUt2] Output mode of OUT2	[HYS] Hysteresis mode	Page 42
	[2ot] Switch operation of OUT2	[2_P] Normal output	
	[P_2] Set value of OUT2	50% of maximums rated flow range [250] 250 L/min (500 L type) [500] 500 L/min (1000 L type) [1000] 1000 L/min (2000 L type)	
	[H_2] Hysteresis of OUT2	5% of maximums rated flow range [25] 25 L/min (500 L type) [50] 50 L/min (1000 L type) [100] 100 L/min (2000 L type)	
	[dtH2] ON delay time	[0.00] 0.00 s	
	[dtL2] OFF delay time	[0.00] 0.00 s	
	[CoL] Display colour of OUT2	[1SoG] Green when ON, Red when OFF (OUT1)	
[F 3]	[FiL] Digital filter setting	[1.0] 1.0 s	Page 48
[F10]	[Sub] Sub display	[dEF] Standard (Set value of OUT1)	Page 49
[F14]	[Cut] Zero cut-off setting	[1.0] 1.0%	Page 55
[F20]	[inP] External input setting *2	[rAC] Accumulated value reset	Page 56
[F22]	[AoUt] Analogue output setting *4	[1-5] 1 to 5 V (Analogue voltage type) [4-20] 4 to 20 mA (Analogue current type)	Page 57
[F30]	[SAvE] Accumulated value hold setting	[oFF] Not held	Page 58
[F80]	[diSP] Display OFF mode	[oN] Normal display (Display ON)	Page 59
[F81]	[P in] Security code	[oFF] Not used	Page 60
[F90]	[ALL] Setting of all functions	[oFF] Not used	Page 62
[F96]	[S_in] Check of input signal	No setting due to input signal setting	Page 63
[F98]	[tESt] OUT Output check	[n] Normal output	Page 64
[F99]	[ini] Reset to the default settings	[oFF] Reset OFF	Page 67

*1: This setting is only available for models with the unit selection function.

*2: This setting is only available for models with the external input.

*3: Only available for models with switch outputs for OUT2.

*4: This setting is only available for models with the analogue output.

■[F 0] Selection of reference condition, unit selection function, switch output specifications.

Reference condition

Standard condition or normal condition can be selected.

Standard condition (ANR) and normal condition (NOR) are defined as follows:

- Standard condition (ANR): 101.3 kPa, 20 °C
- Normal condition (NOR): 101.3 kPa, 0 °C

Unit selection function

The selectable display units are L/min or CFM (ft³/min). *

This setting is only available for models with the unit selection function.

*: This function is not displayed for models without unit selection function.

<Operation>

Press the UP or DOWN button in function selection mode to display [F 0].

Press the SET button. ↓ Move on to the reference condition setting.

Reference condition setting

Press the UP or DOWN button to select the reference condition.



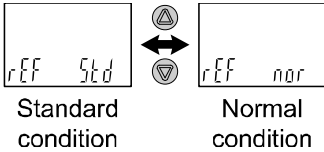

Press the SET button to set. ↓ Move on to display unit setting.

Display unit setting

Press the UP or DOWN button to select the display unit.



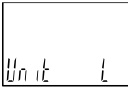

L/min, L



cfm, ft³

*: A product with no units selection function (fixed to SI units) does not indicate the display unit [Ft].

Press the SET button to set. ↓ Move on to the switch output NPN/PNP specification switching setting.



Switching setting of switch output NPN/PNP specifications

The switch output of this product can be switched to NPN or PNP output in accordance with the user device construction.

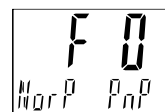

Press the UP or DOWN button to select switch output specification.

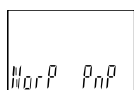

PNP output

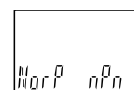

NPN output

Press the SET button to set.
Return to function selection mode.
(No external input)

Press the SET button to set.
Move on to the setting of the switch output/external input.
(With external input)

Switch output/external input setting

Press the UP or DOWN button to select specification of OUT2.

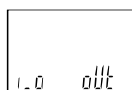

Switch output

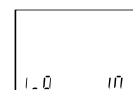

External input

Press the SET button to set.
Return to function selection mode.

[F 0] Setting of reference condition, unit selection, or switch output specification is completed.

Flow specification when [CF] is selected during the unit selection function.

Model			PFMC7501	PFMC7102	PFMC7202
Flow	Rated flow range		0.2 to 17.7 cfm	0.4 to 35.3 cfm	0.8 to 70.6 cfm
	Set flow rate range	Instantaneous flow	0.2 to 18.5 cfm	0.4 to 37.1 cfm	0.8 to 74.2 cfm
		Accumulated flow	0 to 999,999,999 ft ³		
	Minimum setting unit	Instantaneous flow	0.1 cfm		
		Accumulated flow	1 ft ³		
	Accumulated volume per pulse		0.1 ft ³ /pulse		1 ft ³ /pulse
Display	Displayable range	Instantaneous flow	-0.9 to 18.6 cfm (Displays [0] when the value is between -0.2 and 0.2.)	-1.8 to 37.1 cfm (Displays [0] when the value is between -0.4 and 0.4.)	-3.6 to 74.2 cfm (Displays [0] when the value is between -0.8 and 0.8.)
		Accumulated flow	0 to 999,999,999 ft ³		
	Minimum display unit	Instantaneous flow	0.1 cfm		
		Accumulated flow	1 ft ³		

*: Flow rate in the specification is the value at standard condition.

■[F 1] Setting of OUT1

Set the output mode of OUT1.

● Switch output operation list

Select the operation required from the table below. Characters in () are for OUT2.

	Normal output	Reversed output
Hysteresis mode	<p>Output ON/OFF vs. Instantaneous flow. Hysteresis $H_1(H_2)$. Points P_1 (P_2).</p>	<p>Output ON/OFF vs. Instantaneous flow. Hysteresis $H_1(H_2)$. Points n_1 (n_2).</p>
Window comparator mode	<p>Output ON/OFF vs. Instantaneous flow. Hysteresis $H1(H2)$. Points $P1L$ ($P2L$), $P1H$ ($P2H$).</p>	<p>Output ON/OFF vs. Instantaneous flow. Hysteresis $H1(H2)$. Points $n1L$ ($n2L$), $n1H$ ($n2H$).</p>
Accumulated output mode (Increment)	<p>Accumulated flow vs. Time. Set value. Output ON/OFF vs. Time. <ul style="list-style-type: none"> Count up from "0". Turn ON when the set value is reached. Return to "0" by reset. </p>	<p>Accumulated flow vs. Time. Set value. Output ON/OFF vs. Time. <ul style="list-style-type: none"> Count up from "0". Turn OFF when the set value is reached. Return to "0" by reset. </p>
Accumulated output mode (Decrement)	<p>Accumulated flow vs. Time. Set value. Output ON/OFF vs. Time. <ul style="list-style-type: none"> Count down from set value. Turn ON when the "0" is reached. Return to set value by reset. </p>	<p>Accumulated flow vs. Time. Set value. Output ON/OFF vs. Time. <ul style="list-style-type: none"> Count down from set value. Turn OFF when the "0" is reached. Return to set value by reset. </p>
Accumulated pulse output mode	<p>Output ON/OFF vs. Time. Pulse width: 50 ms.</p>	<p>Output ON/OFF vs. Time. Pulse width: 50 ms.</p>

*: The operation may become unstable if hysteresis mode or window comparator mode are used during fluctuating flow conditions. In this case, maintain an interval between the set values and start using after confirming stable operation.

<Flowchart of functions>

1. Selection of output mode

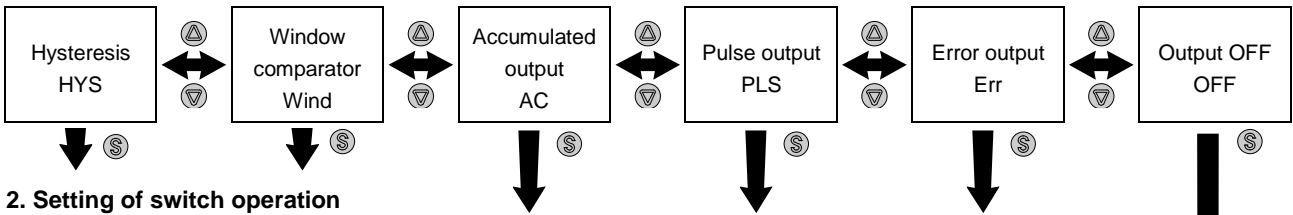

2. Setting of switch operation

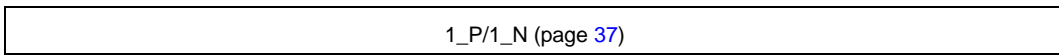

(Selection of display colour)

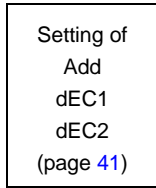

3. Input of set values

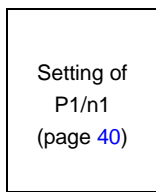
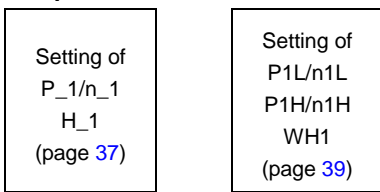

4. Delay time

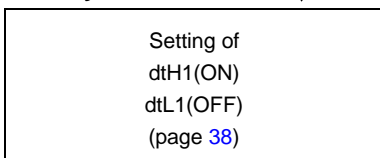

5. Selection of display colour

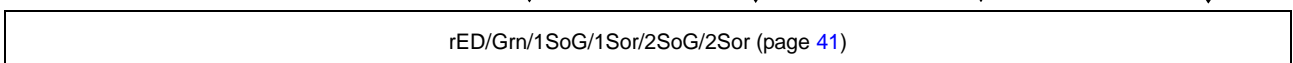

6. Completed

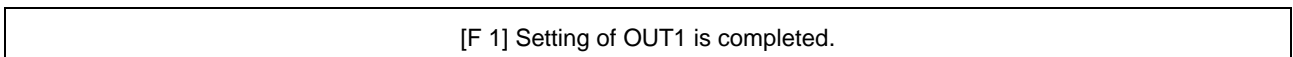

<Operation>

Press the UP or DOWN button in function selection mode to display [F 1].

Press the SET button. ↓ Move on to output mode setting.

Output mode setting

Press the UP or DOWN button to select the output mode.

Press the SET button to set. ↓ Move on to the setting of switch operation.

Setting of switch operation

Press the UP or DOWN button to select the switch operation.

Press the SET button to set. ↓ Move on to the input of set values.

Input of set values

a. When hysteresis output mode is selected

Press the SET button to set. ↓ Move on to the setting of hysteresis.



Hysteresis setting

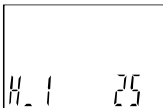

The sub screen (right side) displays the hysteresis value.
Change it with the UP and DOWN buttons.

*: The set value and hysteresis range will be limited depending on the values.

Press the SET button to set. ↓ Move on to delay time setting.

Delay time setting

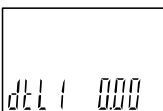
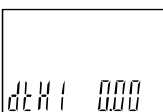

The sub screen (right side) displays the delay time value.
Change it with the UP and DOWN buttons.

Press the SET button to set the OFF delay time [dtL1] after setting the ON delay time [dtH1].

Press the SET button to set. ↓

Move on to display colour setting. (page 41)

Input of set values

b, When window comparator output mode is selected.



The sub screen (right side) displays the set value.
Change it with the UP and DOWN buttons.
(When reversed output is selected, the sub screen (left side) displays [n1L].)

Press the SET button to set. ↓ Move to the input of the [P1H] set value.

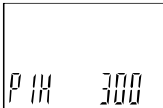

The sub screen (right side) displays the hysteresis value.
Change it with the UP and DOWN buttons.
(When reversed output is selected, the sub screen (left side) displays [n1H].)

Press the SET button to set. ↓ Move on to the setting of hysteresis.

Hysteresis setting



The sub screen (right side) displays the hysteresis value.
Change it with the UP and DOWN buttons.

Press the SET button to set. ↓ Move on to delay time setting.

Delay time setting

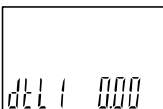
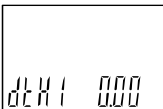

The sub screen (right side) displays the delay time value.
Change it with the UP and DOWN buttons.
Press the SET button to set the OFF delay time [dtL1] after setting the ON delay time [dtH1].

Press the SET button to set. ↓
Move on to display colour setting. (page 41)

Input of set values

c. When accumulated output mode is selected.

Selection of accumulated increment or decrement.
Press the UP or DOWN button to select.

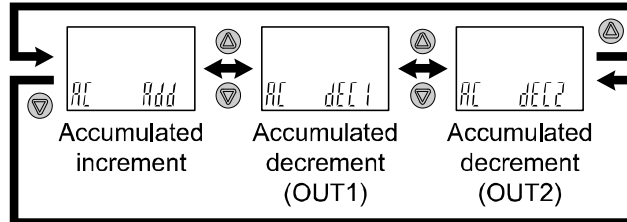
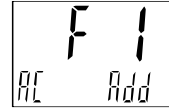

Press the SET button to set. ↓ Move on to the input of set values.



The sub screen (right side) displays the set value.
Change it with the UP and DOWN buttons.

Press the SET button to set. ↓

Move on to display colour setting. (page 41)

●Setting range of the accumulated flow output

The accumulated output setting range is displayed by the set value of the 4 digits and the units.

Set the value by key operation in the sub display. The upper 4 digits of the value is displayed by shifting of the digit. Refer to the table below for details of the set value and display.

Accumulated minimum unit: 10 L

Key operation	Set accumulated value	Sub screen display	
		Value	Units indication
△	0	0	L
↓	to	to	
	1,000	1.000	x10 ³ L
	to	to	
	9,990	9.990	x10 ³ L
	to	to	
•	99,990	99.99	x10 ³ L
•	to	to	
•	1,000,000	1.000	x10 ⁶ L
	to	to	
	10,000,000	10.00	x10 ⁶ L
	to	to	
	99,990,000	99.99	x10 ⁶ L
↑	to	to	
▽	9,999,900,000	9999	x10 ⁶ L

Accumulated minimum unit: 1 L

Key operation	Set accumulated value	Sub screen display	
		Value	Units indication
△	0	0	L
↓	to	to	
	1.000	1.000	x10 ³ L
	to	to	
	9.999	9.999	x10 ³ L
	to	to	
•	99.990	99.99	x10 ³ L
•	to	to	
•	1.000.000	1.000	x10 ⁶ L
	to	to	
	10.000.000	10.00	x10 ⁶ L
	to	to	
	99.990.000	99.99	x10 ⁶ L
↑	to	to	
▽	9,999,000.000	9999	x10 ⁶ L

*: The units on the right side of the sub screen will flash.

Selection of display colour

The display colour (main screen) can be selected depending on the switch output condition.

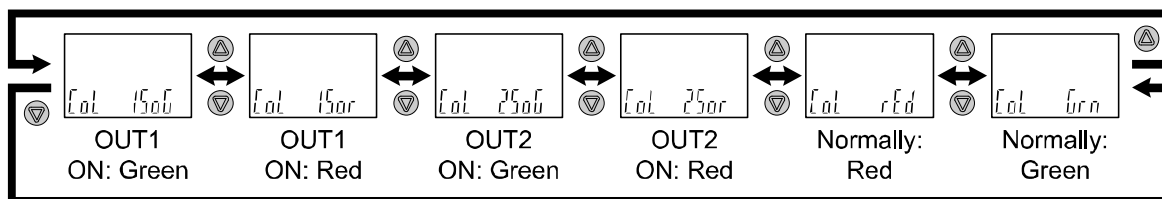
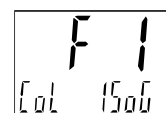

Press the SET button to set. ↓ Return to function selection mode.

[F 1] Setting of OUT1 is completed.

*1: Selected item becomes valid after pressing the SET button.

*2: After enabling the setting by pressing the SET button, it is possible to return to the measurement mode by keeping pressing the SET button for 2 seconds or longer.

■ [F 2] Setting of OUT2

The output mode of OUT2 can be selected.

<Flowchart of functions>

1. Selection of output mode

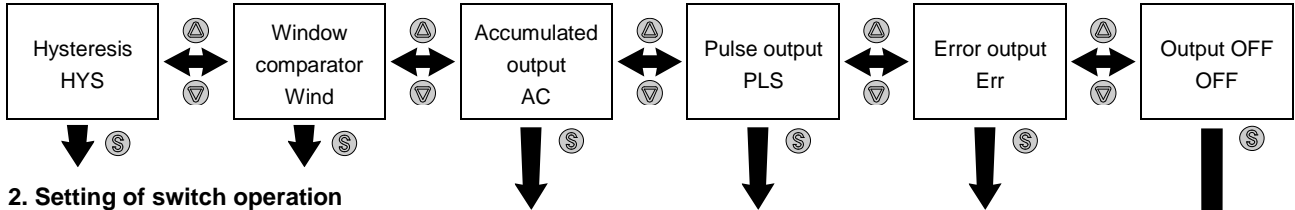

2. Setting of switch operation

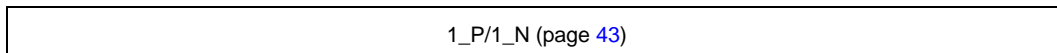

(Selection of display colour)

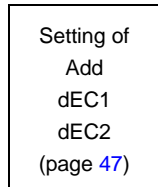

3. Input of set values

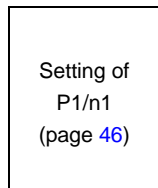
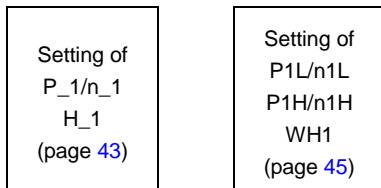

4. Delay time

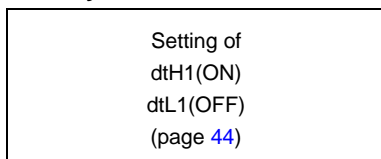

5. Selection of display colour

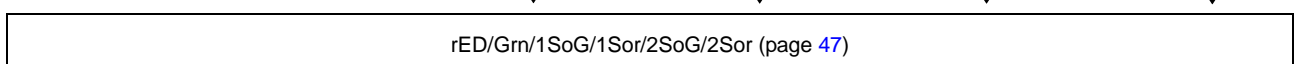

6. Completed

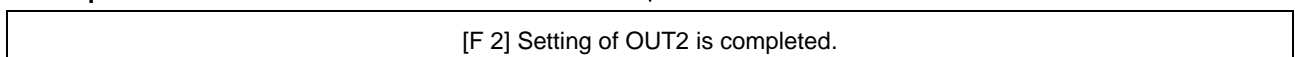

<Operation>

Press the UP or DOWN button in function selection mode to display [F 2].

Press the SET button. ↓ Move on to output mode setting.

Output mode setting

Press the UP or DOWN button to select the output mode.

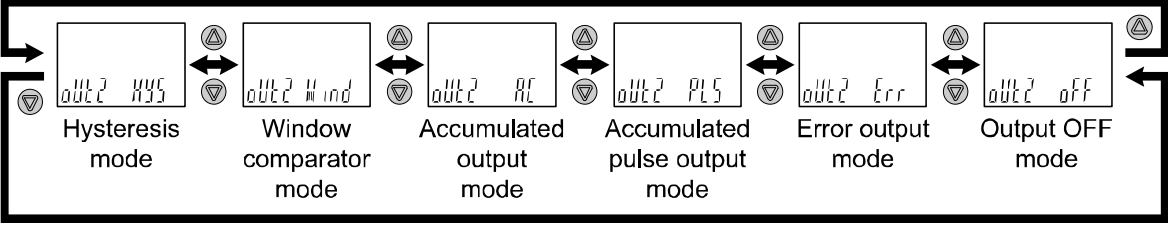

*: When the accumulated pulse output is selected, the output display (Indicator LED) will turn off.

Press the SET button to set. ↓ Move on to the setting of switch operation.

Setting of switch operation

Press the UP or DOWN button to select the switch operation.

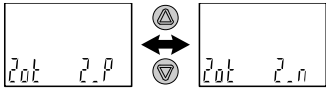

*: By switching the output, the display colour will change in relation to the setting.

Press the SET button to set. ↓ Move on to the input of set values.

Input of set values

a. When hysteresis output mode is selected

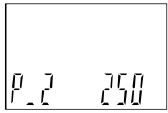

The sub screen (right side) displays the set value.
Change it with the UP and DOWN buttons.
(When reversed output is selected, the sub screen (left side) displays [n_2].)

Press the SET button to set. ↓ Move on to the setting of hysteresis.



Hysteresis setting

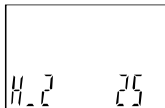

The sub screen (right side) displays the hysteresis value.
Change it with the UP and DOWN buttons.

*: The set value and hysteresis range will be limited depending on the values.

Press the SET button to set. ↓ Move on to delay time setting.

Delay time setting

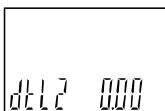
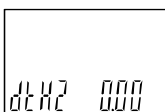

The sub screen (right side) displays the delay time value.
Change it with the UP and DOWN buttons.

Press the SET button to set the OFF delay time [dtL2] after setting the ON delay time [dtH2].

Press the SET button to set. ↓

Move on to display colour setting. (page 47)

Input of set values

b, When window comparator output mode is selected.



The sub screen (right side) displays the set value.
Change it with the UP and DOWN buttons.
(When reversed output is selected, the sub screen (left side) displays [n2L].)

Press the SET button to set. ↓ Move to the input of the [P2H] set value.

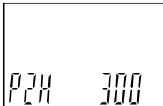

The sub screen (right side) displays the hysteresis value.
Change it with the UP and DOWN buttons.
(When reversed output is selected, the sub screen (left side) displays [n2H].)

Press the SET button to set. ↓ Move on to the setting of hysteresis.

Hysteresis setting



The sub screen (right side) displays the hysteresis value.
Change it with the UP and DOWN buttons.

Press the SET button to set. ↓ Move on to delay time setting.

Delay time setting

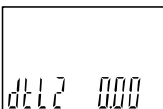
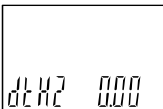

The sub screen (right side) displays the delay time value.
Change it with the UP and DOWN buttons.
Press the SET button to set the OFF delay time [dtL2] after setting the ON delay time [dtH2].

Press the SET button to set. ↓

Move on to display colour setting. (page 47)

Input of set values

b. When window comparator output mode is selected.

Selection of accumulated increment or decrement.
Press the UP or DOWN button to select.

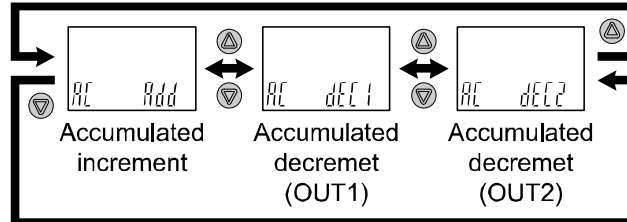

Press the SET button to set. ↓ Move on to the input of set values.



The sub screen (right side) displays the set value.
Change it with the UP and DOWN buttons.

Press the SET button to set. ↓

Move on to display colour setting. (page 47)

Selection of display colour

The display colour (main screen) can be selected depending on the switch output condition.

*: The display colour setting is linked to the [F 1] OUT1 setting.

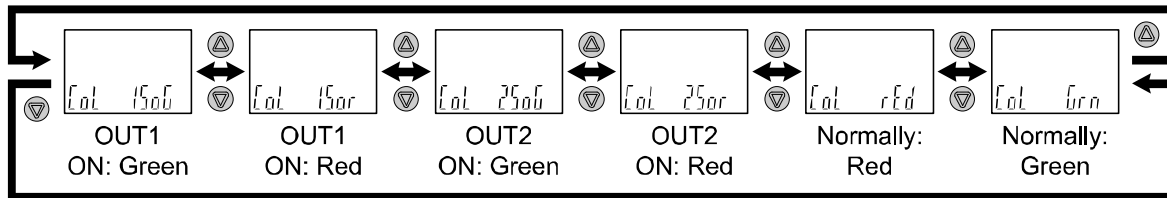
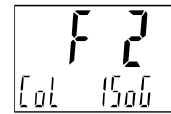

Press the SET button to set. ↓ Return to function selection mode.

[F 2] Setting of OUT2 is completed.

*1: Selected item becomes valid after pressing the SET button.

*2: After enabling the setting by pressing the SET button, it is possible to return to the measurement mode by keeping pressing the SET button for 2 seconds or longer.

■ [F 3] Digital filter setting

Set the digital filter.

Output chattering or flicker in the measurement mode display can be reduced by setting the digital filter.

<Operation>

Press the UP or DOWN button in function selection mode to display [F 3].

Press the SET button. ↓ Move on to digital filter setting.

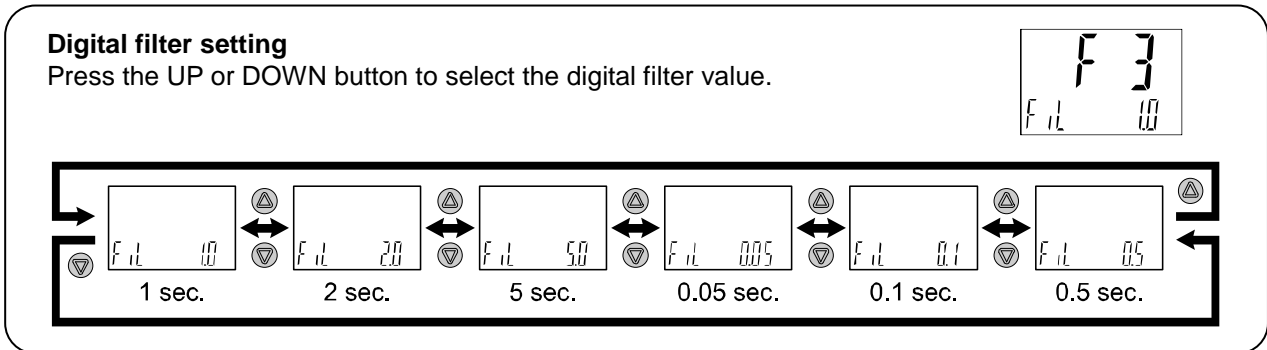

Press the SET button to set. ↓ Return to function selection mode.

[F 3] Response time setting is completed.

*1: Each set value is a guideline for 90% response time.

*2: Both the switch output and flow display are affected. When only switch output needs to be affected, select the delay time setting.
(page 38)

■ [F10] Sub screen setting

Set the sub screen display.

Detailed contents are shown in the pages from 50.

<Operation>

Press the UP or DOWN button in function selection mode to display [F10].

Press the SET button. ↓ Move on to sub screen setting.

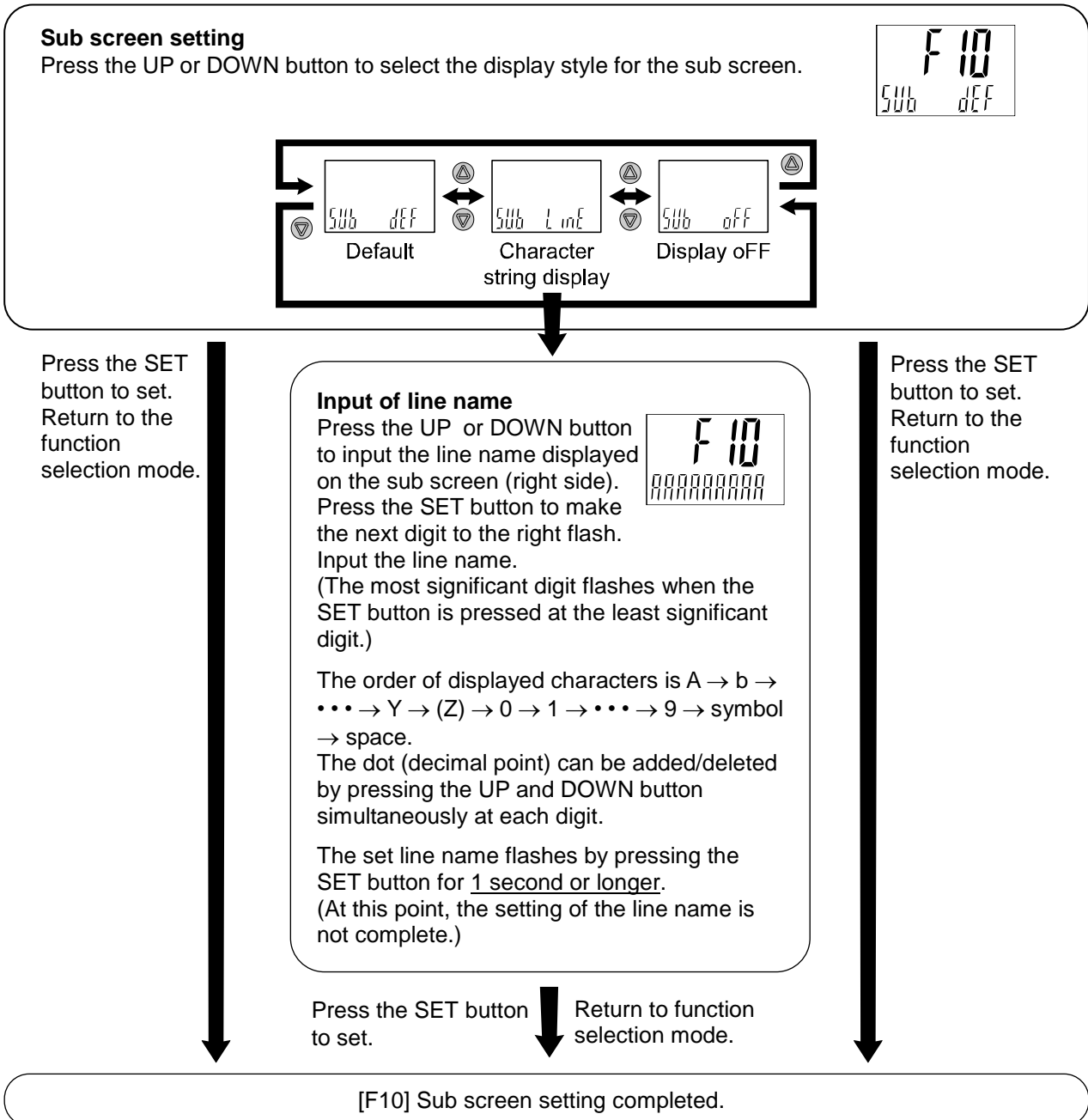

<Sub screen display>

The following display items and values can be displayed on the sub screen.

The displayed item varies depending on the setting of the output mode. Select the displayed items by pressing the UP or DOWN button in measurement mode.

*: Sub screen display (for 500 L range)

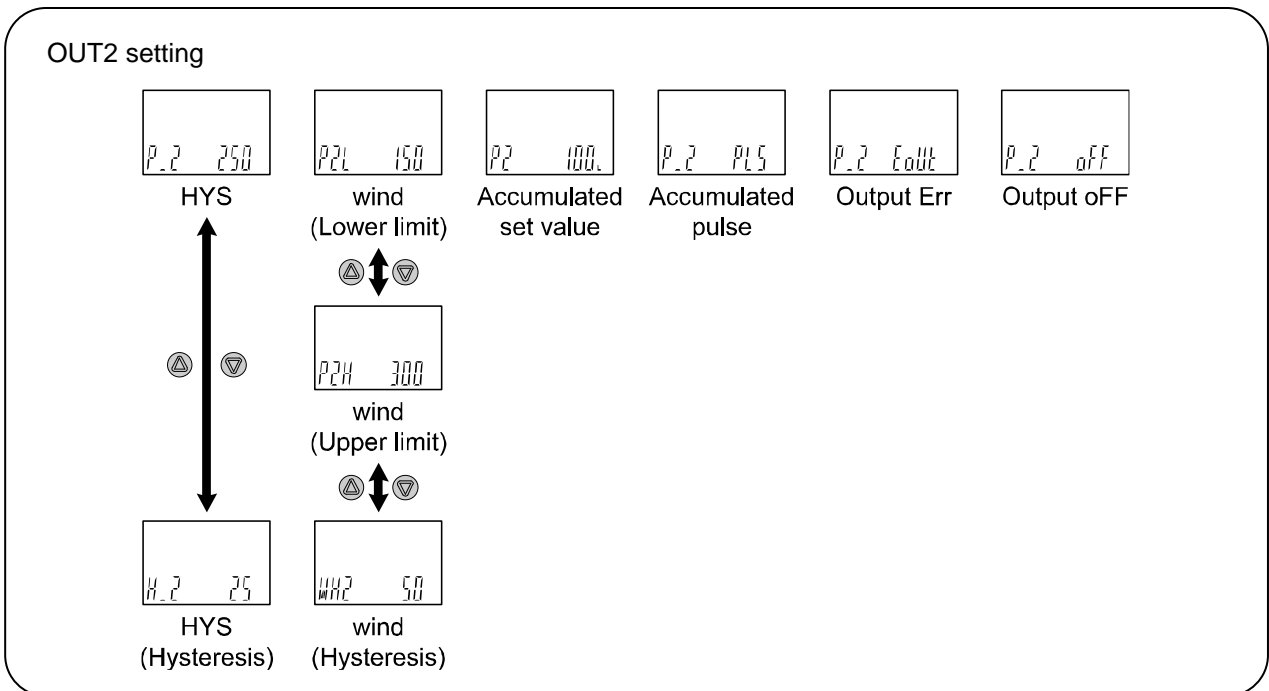
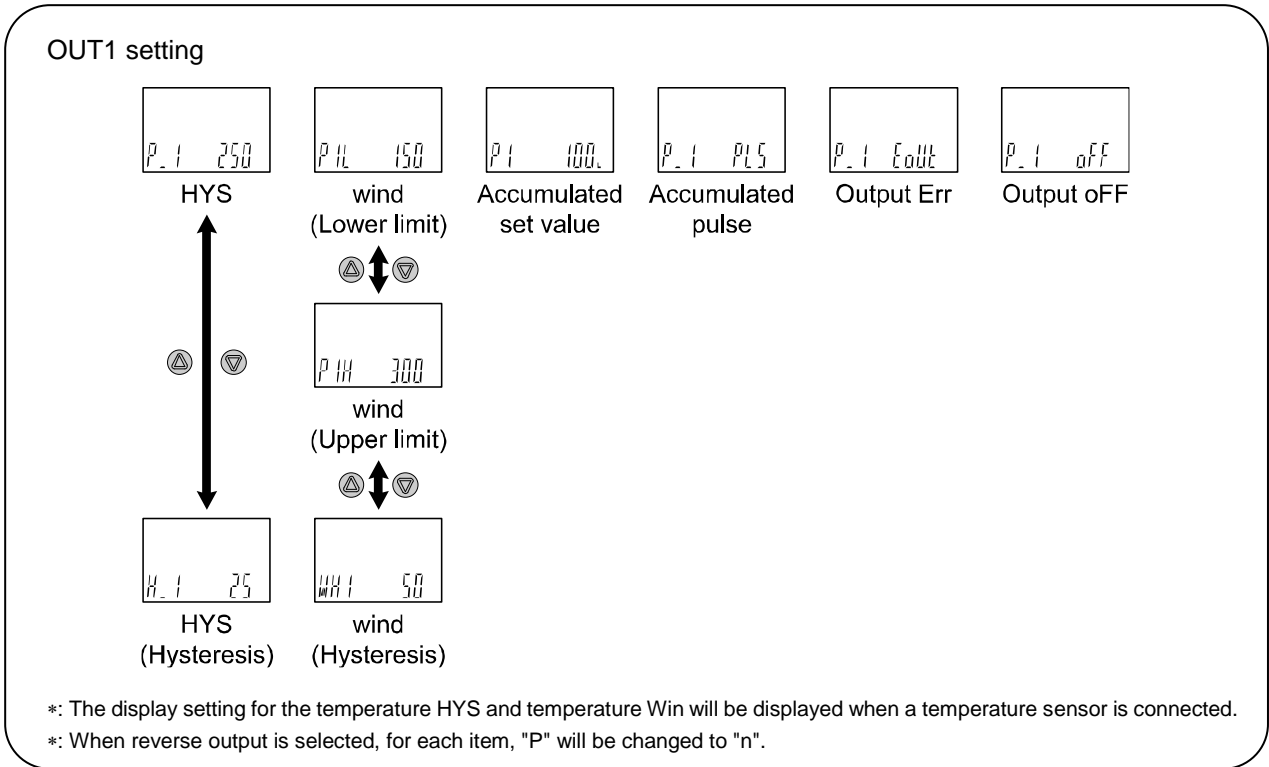



Bottom value display



Peak value display

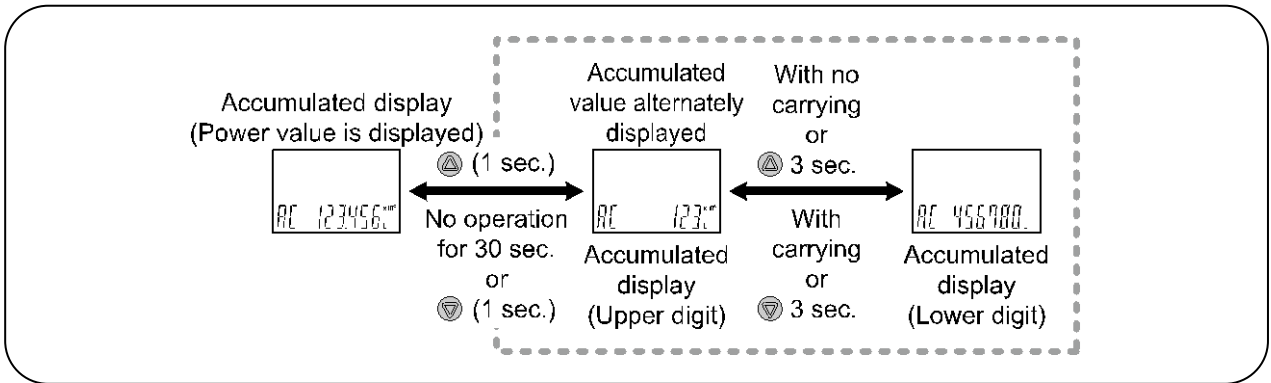



Switch output/communication mode display

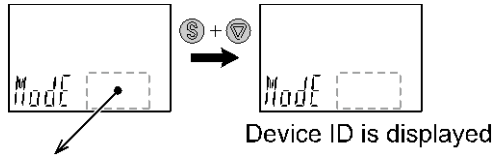

Item	Content	Condition
Sio	SIO mode	SIO mode or WakeUp
Strt	StartUp mode	StartUp
PrE	PreOperate mode	Pre Operate
oPE	Operate mode	Operate
LoC	Data storage LOC mode	Data storage LOC and SIO mode



When the setting of [F10] is other than [dEF]

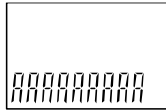

Display of line name
(Characters)



Display OFF



OUT1 setting

•(Temperature) Peak/Bottom value

The maximum flow/temperature (peak) and minimum flow/temperature (bottom) flow from when the power is supplied to this moment is detected and updated.

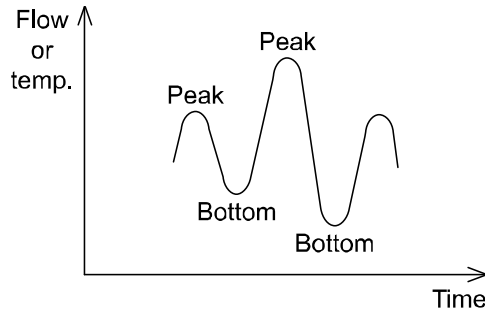

Peak and bottom values can be reset by pressing the SET and DOWN buttons simultaneously for 1 second.

•Display of line name (Character string)

The line name on which the flow switch is used can be displayed. (Max. 4 letters)

When line name is input, characters which can be displayed for each digit are as follows.

A	B	C	D	E	F	G	H	I	J	K	L	M	N	O	P	Q	R	S	T	U	V	W	X	Y	Z
0	1	2	3	4	5	6	7	8	9	Symbol		K	M	N	R	V	W		Space		(Dot)				

A dot (.) is displayed only for the first, second or third digit from the left. It is possible to add or delete the dot by pressing the UP and DOWN buttons simultaneously.

•Display OFF mode

The sub screen remains OFF.

•Display of accumulated value

The power display (Value $\times 10^{\text{Nth}}$ power) and upper digit - lower digit are displayed alternately.

The sub screen always displays power.

When the DOWN button is pressed for 1 second on the accumulated value display screen, the display will be switched alternately.

Power display: The effective upper 4 digits of the accumulated measurement value are displayed.

The dot (decimal point) and units display indicator ($\times 10^3/\times 10^6$) light up due to carrying of the digits.

Alternate display: The accumulated flow measurement value is displayed in two parts, upper digits (7th to 10th digit) and lower digits (1st to 6th digit).

The values are displayed with the lower digits until it exceeds the 6th digit.

When the value exceeds the 6th digit, "Upper digits (3 seconds) \leftrightarrow lower digits (3 seconds)" will be displayed alternately.

*: Accumulated value display example (in case of 500 L range)

Accumulated value	Power value is displayed		Alternate display	
			Upper digits	Lower digits
120 L			No display (only lower digits are displayed).	
123,450 L		∇ (1 sec.) \leftrightarrow No operation for 30 sec.	No display (only lower digits are displayed).	
123,456,780 L		or ∇ (1 sec.)		
9,999,999,999 L (maximum accumulated flow value exceeded)				

■[F14] Zero-cut setting

A function to force the display to zero to remove flickering at the lower measurement range.

<Operation>

Press the UP or DOWN button in function selection mode to display [F14].

Press the SET button. ↓ Move on to the setting of the zero cut-off display function.

Setting of zero cut-off function

Press the UP or DOWN button to select the zero cut-off value.

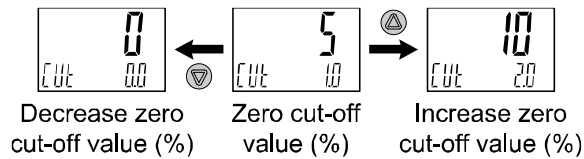
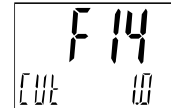

*: The display above is an example when [L] is selected in PFMC7501 (500 L/min type) with unit selection function.

Press the SET button to set. ↓ Return to function selection mode.

[F14] Zero cut-off setting completed.

■[F20] Setting of external input

This function is available when the model includes the external input function. The accumulated flow, peak value and bottom value can be reset remotely.

*: When using a model without external input function, this setting is not available and [---] will be displayed.

●**Accumulated flow external reset:** A function to reset the accumulated flow value when an external input signal is applied.

In accumulated increment mode, the accumulated flow value will reset to zero, and then increase from zero.

In accumulated decrement mode, the accumulated flow value will reset to a set value, and then decrease from the set value.

*: Each time the accumulated flow external reset is activated and when the accumulated flow value is stored, a memory device (EEPROM) is accessed. The memory device has a limit of 1 million cycles. When using the product, it should be considered that the total number of external input resets and accumulated values stored must not exceed 1 million.

●**Peak/Bottom value reset:** A function to clear the peak value or bottom value when an external input signal is applied.

●**OFF:** The external input function will not operate.

<Operation>

Press the UP or DOWN button in function selection mode to display [F20].

Press the SET button. ↓ Move on to setting of external input.

Setting of external input
Press the UP or DOWN button to select the external input equipment.



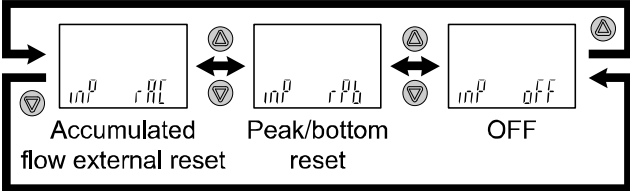

Press the SET button to set. ↓ Return to function selection mode.

[F20] Setting of external input completed.

Input signal: Connect the external input to GND for NPN type. Connect to Vcc for PNP type. 30 msec. or longer.

- When the input signal is ON, the screen will display [000] for 1 second.
- After turning OFF the input signal, flow accumulation resumes (displays peak value and bottom value) within 30 msec.
- To input successive signals, the [000] display must clear before the next signal is input.

■ [F22] Analogue output setting

This function is available when the model includes the analogue output.
Change the analogue output set value and analogue free range.

* When using a model without analogue outputs, this setting is not available and [- -] will be displayed.

<Operation>

Press the UP or DOWN button in function selection mode to display [F22].

Press the SET button. ↓ Move on to the setting of analogue output.

Setting of analogue output (voltage output only)

Press the UP or DOWN button to select 1 to 5 V output or 0 to 10 V output.

F22
Rout 1-5

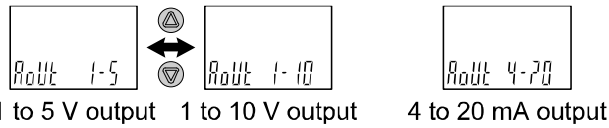

*: Only 4 to 20 mA is available for current output. The display will be [4-20] and not settable.

Press the SET button to set. ↓ Move on to analogue free range mode setting.

Analogue free range mode setting

Press the UP or DOWN button to select the analogue free range mode.

F22
FREE off

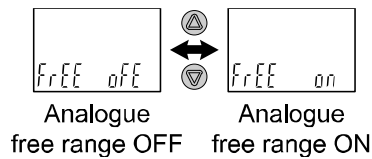

[OFF] is selected

Press the SET button to set.

[ON] is selected

Press the SET button to set.

Input of set value

Press the UP or DOWN button to set the flow value that will output 5 V (10 V) or 20 mA.

F22
F_H 500

The entered flow value can be in the range: 10% of the maximum rated flow, to the max. displayable range.

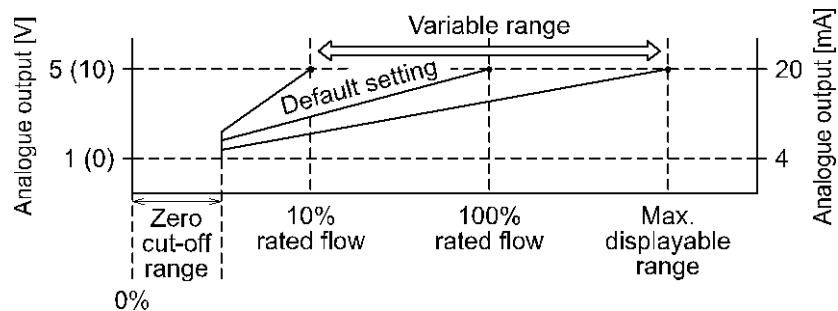

Press the SET button to set. ↓ Return to function selection mode.

[F22] Setting of analogue output completed.

■[F30] Accumulated flow value hold setting

Select the setting in which the accumulated flow measurement value is stored to the internal memory. The default setting is not to store the accumulated flow when the power supply is turned off.

This function enables the accumulated flow value to be stored in permanent memory every 2 or 5 minutes. The internal memory life varies depending on the number of times that the memory device can be accessed, so this must be taken into account before use.

If the product is operated 24 hours per day, the maximum writable limit will be as follows:

Data memorized every 5 minutes --- 5 minutes x the number of times the memory device can be accessed (3.7 million cycles) = 1850 million minutes = Approx. 35 years

Data memorized every 2 minutes --- 2 minutes x the number of times the memory device can be accessed (3.7 million cycles) = 740 million minutes = Approx. 14 years

<Operation>

Press the UP or DOWN button in function selection mode to display [F30].

Press the SET button. ↓ Move to the accumulated flow value hold setting.

Accumulated flow value hold setting

Select the accumulated flow value hold setting by pressing the UP or DOWN button.



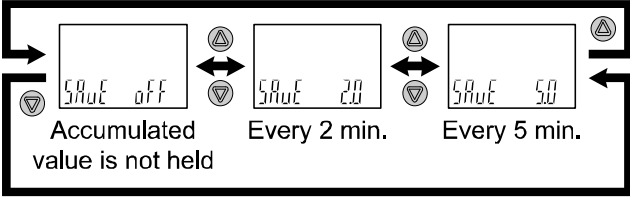

Press the SET button to set. ↓ Return to function selection mode.

[F30] Accumulated flow value hold setting is completed.

*: Data memorization is performed every 2 or 5 minutes (depending upon the setting chosen), this means that the accumulated flow value for up to 2 or 5 minutes before the power supply is turned off will not be added to the device memory.

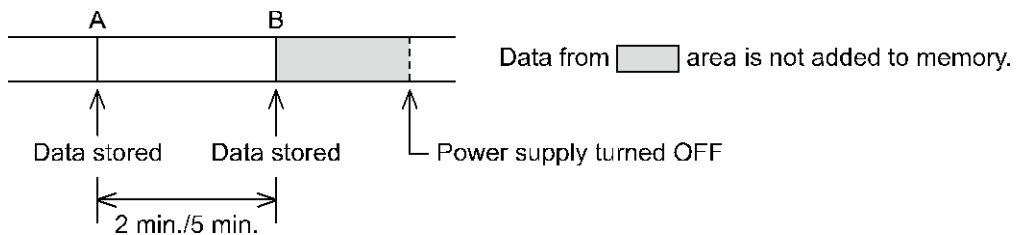

When the power supply is turned on again, the accumulated flow count will start from the value recorded at B.

■ [F80] Display OFF mode setting

Select the display ON/OFF mode.

With this function, the display will change to OFF mode when no button operations are performed for 30 seconds.

During the display OFF mode operation, the under bars on the right side of the sub screen will flash for 3 digits.

In the default setting, power saving mode is OFF (normal mode).

<Operation>

Press the UP or DOWN button in function selection mode to display [F80].

Press the SET button. ↓ Move to the display OFF mode setting.

Display OFF mode setting

Select the display OFF mode setting by pressing the UP and DOWN buttons.

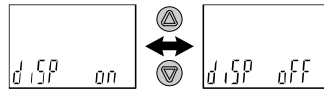

Press the SET button to set. ↓ Return to function selection mode.

[F80] Display OFF mode setting is completed.

With the display OFF mode, when a button operation is performed, normal operation is resumed. When a button operation is not performed for 30 seconds, the display will return to the display OFF mode (only for measurement mode).

The display during the display OFF mode will be as follows.

- Main screen: OFF
- Sub screen (left side): OFF
- Sub screen (right side): Under bars (▬) for 3 digits will flash.
- Unit display LED: OFF
- Indicator LED: Flashes according to the switch operation status
- Communication indicator LED: Flashes according to the communication status (IO/Link mode)



Switch ON



Switch OFF



IO-Link mode

■[F81] Setting of security code

The Security code can be changed during key lock mode.

<Operation>

Press the UP or DOWN button in function selection mode to display [F81].

Press the SET button. ↓ Move on to security code.

Security code
Press the UP or DOWN button to select the setting of security code.

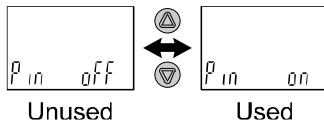

Unused Used



[OFF] (Unused) is selected.
Press the SET button to return to function selection mode.

Press the SET button to set. ↓ Move on to security code checking.

Security code checking
Press the UP or DOWN button to input the security code on the sub screen (right side) (The default setting is [000].) □



For instructions on how to enter the security code, refer to "How to input and change the security code" on page 71.

If the security code entered is incorrect, [FAL] will be displayed, and the security code must be entered again.
If the wrong security code is entered 3 times, [nG] is displayed and the device returns to function selection mode.

Press the SET button for 1 second to set. ↓ Move on to security code changing.

Security code changing

Press the UP or DOWN button to input the changed security code on the main screen. *
For instructions on how to enter the security code, refer to "How to input and change the security code" on page 71.



After entry, the changed security code will flash by pressing the SET button for 1 second.
(At this point, the changing of the security code is not completed)
Return to the change of setting again by pressing the UP or DOWN button.



Press the SET button to set. ↓ Return to function selection mode.

[F81] Setting of security code completed.

If the security code function is enabled, it is will be necessary to input a security code to release the key-lock.

*: If a key is not pressed for 30 seconds while entering the security code, function selection mode will return.

■[F90] Setting of all functions

All functions can be set one after the other, without having to select each one separately from the function selection mode.

<Operation>

Press the UP or DOWN button in function selection mode to display [F90].

Press the SET button. ↓ Move on to setting of all functions.

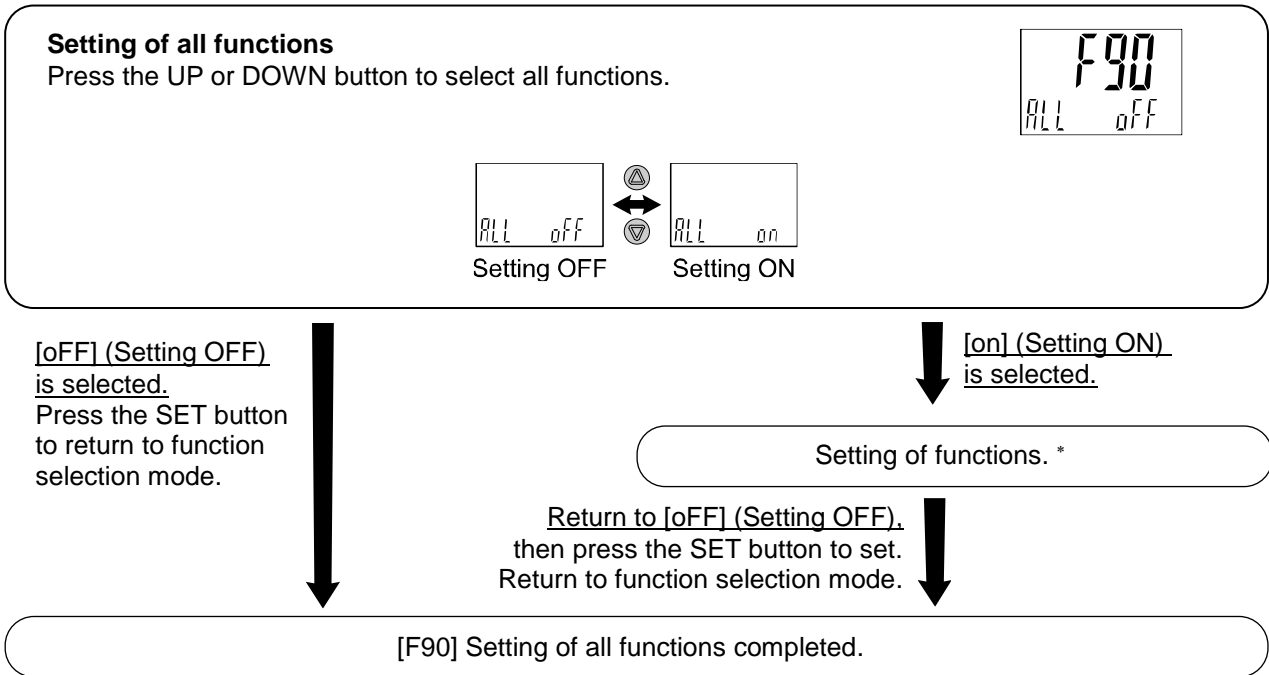

Order of function settings

Order	F number	Items	Notes
1	F 0	Switching function of reference condition, unit selection function, switch output specifications	All models
2	F 1	Setting of OUT1	All models
3	F 2	Setting of OUT2	SW2 output type
4	F 3	Digital filter setting	All models
5	F10	Sub screen setting	All models
6	F14	Zero cut-off setting	All models
7	F20	Setting of external input	Model with external input function
8	F22	Setting of analogue output	Analogue output type
9	F30	Accumulated flow value hold setting	All models
10	F80	Display OFF mode setting	All models
11	F81	Setting of security code	All models

■[F96] Check of external input signal

When the external input is selected, ON / OFF of the input signal can be checked.

*: When the analogue output is selected, ON/OFF of the input signal cannot be checked.

<Operation>

Press the UP or DOWN button in function selection mode to display [F96].

Press the SET button. ↓ Move on to check of external input signal.

Check of external input signal



The display shows OFF when there is no input signal, and it displays ON when there is an input signal.



No input signal

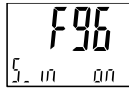

With input signal

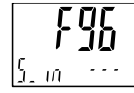

When analogue output
is selected

Press the SET button to set. ↓ Return to function selection mode.

[F96] Check of external input signal completed.

■[F98] Setting of output check

The operation of the output can be checked by switching the output ON/OFF by pressing a button, without the need for a flow of fluid.

<Operation>

Press the UP or DOWN button in function selection mode to display [F98].

Press the SET button. ↓ Move on to select of output check.

Select of output check
Press the UP or DOWN button to select all function setting.



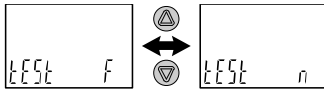

Normal output
(Output is not
checked)

Normal output
(Output is
checked)

[n] (Normal output) is selected.

Press the SET button to set.

Return to function selection mode.

[F] (Forced output) is selected.
Press the SET button to set.

Move on to output check of OUT1.

Output check of OUT1
Press the UP or DOWN button to select output check of OUT1.



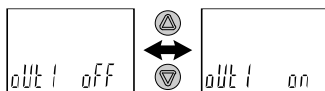

Forced output
OFF

Forced output
ON

[F] (Forced output) is selected.
Press the SET button to set.

Move on to output check of OUT2.

Output check of OUT2
Press the UP or DOWN button to select output check of OUT2.

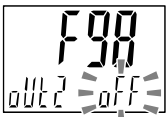

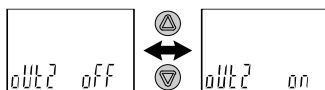

Forced output
OFF

Forced output
ON

アナログ出力付製品の場合

Press the SET button to set.

Move on to analogue output check.

Analogue output check

Press the UP or DOWN button to select analogue output check.

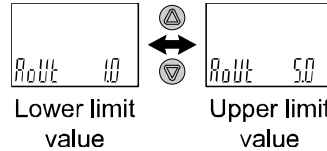

- *: When 0-10V is selected for voltage output type, [0.0] ⇔ [10.0] is displayed.
- *: For current output type, [4] ⇔ [20] is displayed.

When the product is used in SIO mode

Press the SET button to set.
Move on to function selection mode.

When the product is used in SDCI mode (IO-Link)

Press the SET button to set.
Move on to the PD diagnostic bit check.

PD diagnostic bit (flow) check

Press the UP or DOWN button to select diagnostic bit (flow) check.

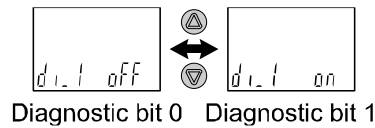

- *: This function is available with IO-Link communication.
- *: Refer to page 78 for details of the diagnostic information.

Press the SET button to set.

Move on to PD diagnostic bit (flow) check.

PD diagnostic bit (error) check

Press the UP or DOWN button to select diagnostic bit (error) check.

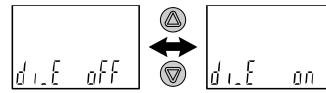

Diagnostic bit 0 Diagnostic bit 1

*: This function is available with IO-Link communication.

*: Refer to page 78 for details of the diagnostic information.

Press the SET button to set.

Move on to PD diagnostic bit (flow) check.

PD flow measurement check

Press the UP or DOWN button to select PD flow measurement check.

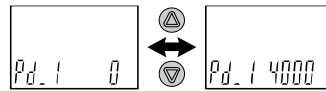

Lower limit of the PD rated value Upper limit of the PD rated value

*: This function is available with IO-Link communication.

Press the SET button to set.

Return to function selection mode.

[F98] Setting of output check completed.

*: Measurement mode can return from any setting item by pressing the SET button for 2 seconds or longer.

*: An increase or decrease in flow will have no effect on the output while the output operation is being performed.

*: PD stands for Process data. Refer to page 73 for further details of the PD.

■[F99] Reset to default settings

If the product settings are uncertain, the default values can be restored.

<Operation>

Press the UP or DOWN button in function selection mode to display [F99].

Press the SET button. ↓ Move on to reset to default settings.

Reset to default settings

Press the UP or DOWN button to display [ON], then press the SET and DOWN buttons simultaneously for 5 second or longer.

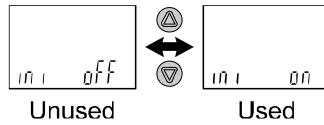

[oFF] (Unused) is selected.
Press the SET button to set.
Return to function selection mode.

All settings are returned to the default values. Return to function selection mode.

[F99] Reset to default settings completed.

Other Functions

○ Snap shot function

The current flow/temperature value can be stored to the switch output ON/OFF set point.

When the items of sub screen (left side) below are selected in 3 step setting mode, simple setting mode or function selection mode ([F 1] Setting of OUT1, [F 2] Setting of OUT2), by pressing the UP and DOWN buttons simultaneously for 1 second or longer, the value of the sub screen (right side) shows [- - -], and then values corresponding to the current flow are automatically displayed.

Output mode	Configurable items	Sub screen (left side)	Snap shot function
Hysteresis mode	Set value	$P_{-1} (n_{-1}) / P_{-2} (n_{-2})$	○
	Hysteresis	H_{-1} / H_{-2}	○
Window comparator mode	Set value	$P_{1L} (n_{1L}), P_{1H} (n_{1H})$ $P_{2L} (n_{2L}), P_{2H} (n_{2H})$	○
	Hysteresis	H_{1L} / H_{1H} H_{2L} / H_{2H}	×

• Set value

The value is set to the same value as the display value (current flow).

(There is a range which cannot be set to the current flow depending on the hysteresis. In that case, the value is set to the closest value.)

• Hysteresis

The hysteresis is calculated from the equation below and set.

Normal output: (set value) - (current flow)
Reverse output: (current flow) - (set value)

If the calculation result becomes 0 or less, [Err] is displayed on the sub screen (right side) and the set value is not changed.

Afterwards, it is possible to adjust the value by pressing the UP or DOWN button.

○ Peak/bottom value indication

The maximum (minimum) flow when the power is supplied is detected and updated.

In peak/bottom indication mode, the current pressure is displayed.

Press the UP or DOWN button in measurement mode to switch the sub screen (left side) to the display shown below.

Peak/bottom values are displayed on the sub screen (right side) at the same time as the current flow on the main screen.

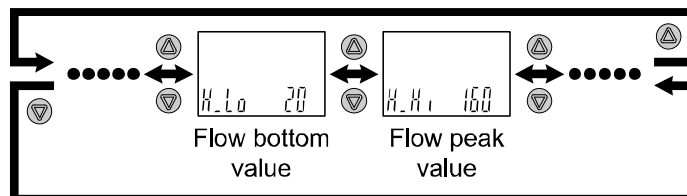

Peak/Bottom value is cleared if the power supply is disconnected.

When the SET and DOWN buttons are pressed for 1 second or longer simultaneously while the peak/bottom values are displayed, the sub screen (right side) displays [- - -] and the maximum (minimum) flow are cleared.

○Key-lock function

The key-lock function is used to prevent errors occurring due to unintentional changes of the set values. If the SET button is pressed while the keys are locked, [LoC] is displayed on the sub screen (left side) for approximately 1 second.

(Each setting and peak/bottom values are displayed with UP and DOWN buttons.)

<Operation - Without security code input ->

- (1) Press the SET button for 5 seconds or longer in measurement mode. When [oPE] is displayed on the main screen, release the button.

The current setting [LoC] or [UnLoC] will be displayed on the sub screen.

(To release key-lock repeat the above operation.)

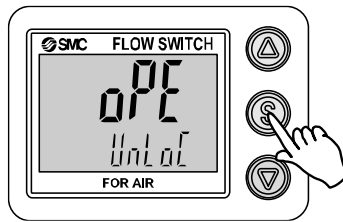

- (2) Select the key-locking/un-locking with UP or DOWN button, and press the SET button to set.

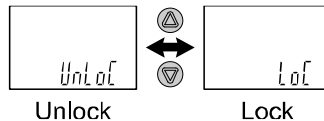

<Operation – With security code input ->

•Locking

- (1) Press the SET button for 5 seconds or longer in measurement mode. When [oPE] is displayed on the main screen, release the button.

The current setting [LoC] or [UnLoC] will be displayed on the sub screen.

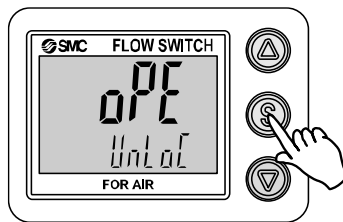

- (2) Select the key [LoC] with UP or DOWN button, and press the SET button to set.

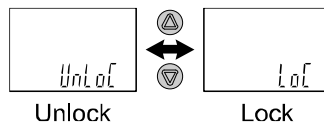

•Unlocking

- (1) Press the SET button for 5 seconds or longer in measurement mode. When [oPE] is displayed on the main screen, release the button.
The current setting [LoC] or [UnLoC] will be displayed on the sub screen.

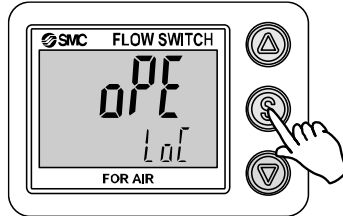

- (2) Select the un-locking [UnLoC] with UP or DOWN button. Setting is recognized by pressing the SET button, then security code is required.

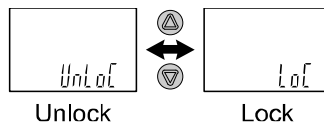

- (3) For instructions on how to enter the security code, refer to "How to input and change the security code" on page 71.

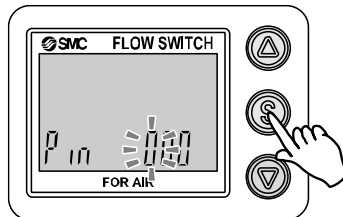

- (4) If inputted security code is correct, the indication of the main screen changes to [UnLoC], and pressing the one of UP, SET or DOWN button releases key-lock and the measurement mode returns.
If the security code entered is incorrect, [FAL] will be displayed, and the security code must be entered again. If the wrong security code is entered 3 times, [LoC] is displayed and the device returns to measurement mode.

● **How to input and change the security code**

The left most digit starts flashing.

Press the UP or DOWN button to select a value.

Press the SET button to make the next digit to the right flash.
(If the SET button is pressed at the last digit, the first digit will start flashing.)

After the setting is complete, Press and hold the SET button for 1 second or longer.

(If an operation is not performed for 30 seconds during input or change of the security code, it will return to measurement mode.)

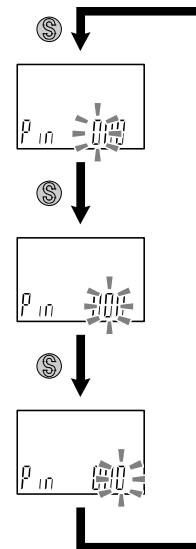

Maintenance

How to reset the product after a power cut or when the power has been unexpectedly removed

The settings of the product are retained from before the power cut or de-energizing.

The output condition also recovers to that before power cut or de-energizing, but may change depending on the operating environment. Therefore, check the safety of the whole installation before operating the product.

IO-Link Specifications

■ Outline of IO-Link functions

○ Communication function

This product can check the flow/temperature measurement value, diagnostic information and switch output status using cyclic data communication via the IO-Link system.

○ Product status monitoring function

This function monitors the product status via the IO-Link.

- Several errors (e.g. internal hardware errors) can be monitored.
- Several warnings (e.g. temperature sensor error, flow measurement error) can be detected.

○ Data storage function

The Data storage function stores the IO-Link device parameter settings to the IO-Link master.

With the IO-Link data storage function, the IO-Link device can be replaced easily without re-setting the equipment construction or setting parameters

When the device parameter is set and downloaded to the device using the IO-Link setting tool, the parameter will be uploaded to the data storage in the master by the system command after download (backup instruction by the communication command).

When the device is replaced with the same type of IO-Link device due to failure, the parameter settings stored in the master are downloaded automatically, device can be operated with the parameter settings of the previous device.

Device parameter setting is applicable to 3 types of back-up levels of the master setting ("Inactive", "back-up/Restore", "Restore").

"Back-up" implies the activation of upload and "restore" implies download.

■ Communication specifications

IO-Link type	Device
IO-Link version	V1.1
Communication speed	COM2 (38.4 kbps)
Min. cycle time	3.4 ms
Process data length	Input Data: 4 byte, Output Data: 0 byte
On request data communication	Available
Data storage function	Available
Event function	Available

■ Process data

Process data is the data which is exchanged periodically between the master and device.

This product process data consists of switch output status, error diagnostics, flow measurement value and temperature measurement value.

(Refer to the table below.)

Bit offset	Item	Notes
0	OUT1 output	0: OFF 1: ON
1	OUT2 output	0: OFF 1: ON
8	Flow diagnosis	0: Within range 1: Out of range (HHH/LLL).
9	Fixed output	0: Normal output 1: Fixed output (for checking output)
15	Error diagnosis	0: Error is not generated 1: Error is generated
16 to 31	Flow measurement value	With sign: 16 bit

Bit offset	31	30	29	28	27	26	25	24	23	22	21	20	19	18	17	16
Item	Flow measurement value (PD)															

Bit offset	15	14	13	12	11	10	9	8	7	6	5	4	3	2	1	0
Item	Error Diagnosis	Fixed output	Reservation				Flow Diagnosis	Reservation				OUT2	OUT1	Switch output		

•The process data of this product is Big-Endian type.

When the transmission method of the upper communication is Little-Endian, the byte order will be changed.

Refer to the table below for the Endian type of the major upper communication.

Endian type	Upper communication protocol
Big-Endian type	Such as PROFIBUS and PROFINET
Little-Endian type	Such as EtherNET/IP, EtherCAT and CC-Link IE Field.

○Unit specification and flow measurement value (PD)

Series	Unit	Flow range	Flow value		PD value					
			Rated flow range		Display/settable range		Rated flow range		Display/settable range	
			Min.	Max.	Min.	Max.	A	B	C	D
PFMC7	L/min	500 L	5	500	-25	525	40	4000	-200	4200
		1000 L	10	1000	-50	1050				
		2000 L	20	2000	-100	2100				
	cfm	500 L	0.17	17.66	-0.90	18.50				
		1000 L	0.35	35.31	-1.80	37.10				
		2000 L	0.70	70.63	-3.50	74.20				

The flow ranges and relationship between the fluid and PD are shown in the figures below.

●Relationship between flow rate and PD

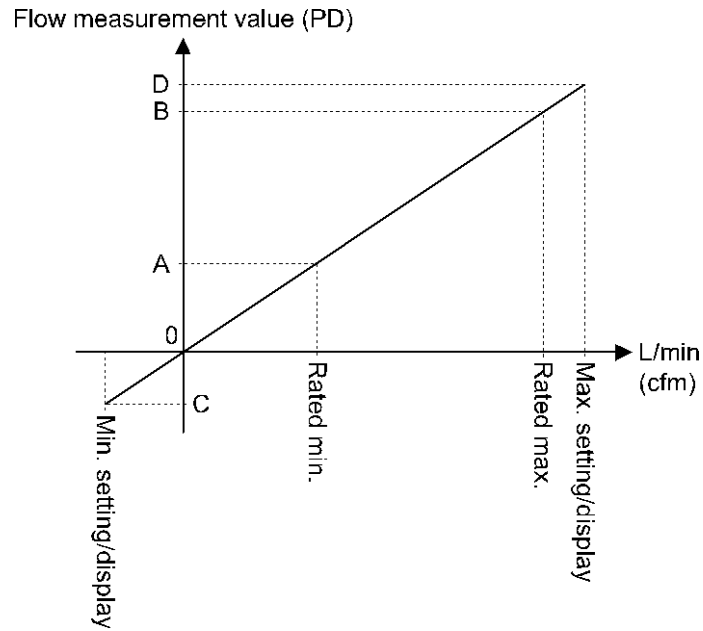

○ Conversion formula of the process data and flow measurement value

(1) Conversion formula from the process data to the flow measurement value: $Pr = a \times (PD) + b$

(2) Conversion formula from the flow measurement value to the process data: $(PD) = (Pr - b) / a$

Pr: Flow measurement value and pressure set value

PD: Flow measurement value (process data)

a: Inclination

b: Intercept

[Inclination and intercept to the unit specification]

Series	Unit	Flow range	Inclination a	Intercept b
PFMC7	L/min	4 L	0.125	0
		16 L	0.25	0
		40 L	0.5	0
	cfm	4 L	0.004415	0
		16 L	0.0088275	0
		40 L	0.0176575	0

[Calculation example]

(1) Conversion from the process data to the flow measurement value
(For PFMC7 series, unit L/min, flow range 1000 L and PD = 2500)

$$\begin{aligned} Pr &= a \times (PD) + b \\ &= 0.25 \times 2500 + 0 \\ &= 625 \text{ [L/min]} \end{aligned}$$

(2) Conversion from the flow measurement value to the process data
(For PFMC7 series, unit L/min, flow range 1000 L and Pr = 800 [L/min])

$$\begin{aligned} (PD) &= (Pr - b) / a \\ &= [800 - 0] / 0.25 \\ &= 3200 \end{aligned}$$

■ IO-Link parameter setting

○ IODD file

IODD (I/O Device Description) is a definition file which provides all properties and parameters required for establishing functions and communication of the device.

IODD includes the main IODD file and a set of image files such as vendor logo, device picture and device icon.

The IODD file is shown below.

Product No.	IODD file *
PFMC7***-L*	SMC-PFMC7***-L***-yyyymmdd-IODD1.1

: "" indicates the product No., and the product No. applicable to each IODD file input.

*: "yyyymmdd" indicates the file preparation date. yyyy is the year, mm is the month and dd is the date.

The IODD file can be downloaded from the SMC Web site (<https://www.smcworld.com>).

○ Service data

The tables below indicate the parameters which can be read or written by simple access parameter (direct parameters page) and ISDU parameters which are applicable to various parameters and commands.

● Direct parameters page 1

DPP1 address	Access	Parameter name	Initial value (dec)	Content
0x07	R	Vendor ID	0x0083 (131)	"SMC Corporation"
0x08				
0x09	R	Device ID	0x021D (541)	PFMC7501***-L****
0x0A			0x021E (542)	PFMC7501***-L2****
			0x021F (543)	PFMC7501***-L3****
			0x0220 (544)	PFMC7501***-L4****
			0x0221 (545)	PFMC7102***-L****
			0x0222 (546)	PFMC7102***-L2****
			0x0223 (547)	PFMC7102***-L3****
0x0B			0x0224 (548)	PFMC7102***-L4****
			0x0225 (549)	PFMC7202***-L****
			0x0226 (550)	PFMC7202***-L2****
			0x0227 (551)	PFMC7202***-L3****
			0x0228 (552)	PFMC7202***-L4****

●ISDU parameters

Index (dec)	Sub index	Access *1	Parameters	Initial value	Remarks
0x0002 (2)	0	W	System command	-	Refer to "System command" on page 77.
0x000C (12)	0	R/W	Device access lock	0x0000	Refer to "Device access lock parameter" on page 78.
0x0010 (16)	0	R	Vendor name	SMC Corporation	
0x0011 (17)	0	R	Vendor text	www.smcworld.com	
0x0012 (18)	0	R	Product name	Example: PFMC7xx-xx-Lx-xxx	
0x0013 (19)	0	R	Product ID	Example: PFMC7xx-xx-Lx-xxx	
0x0014 (20)	0	R	Product text	Flow sensor	
0x0015 (21)	0	R	Serial number	Example: "xxxxxxxx"	•Initial value is indicated as 8 digits. •16 octets fixed character string
0x0016 (22)	0	R	Hardware version	HW-Vx.y	x: Large revision number y: Small revision number
0x0017 (23)	0	R	Software version	FW-Vx.y	x: Large revision number y: Small revision number
0x0024 (36)	0	R	Device status parameter	-	Refer to "Device state parameters" on page 78.
0x0025 (37)	0	R	Device detailed state parameter	-	Refer to "Device detailed state parameter" on page 78.
0x0028 (40)	0	R	Process data input	-	The latest value of process data can be read.

*1: R: Read, W: Write

●System command (index 2)

In the ISDU index 0x002 SystemCommand (system command), the command shown in the table below will be issued.

The button of each system command is displayed on the IO-Link setting tool (excluding "ParamDownloadStore").

Click the button to send the system command to the product.

Writable commands are shown below.

Data type: 8 bit UInteger

Value	Function definition	Description
128	Device Reset	Restarts the device
129	Application Reset	Reset of the peak/bottom value (flow/temperature) Reset of the accumulated flow value
130	Restore Factory Reset	Initialize the set value to the default value.
160	Zero clear	Zero clear
170	Flow peak bottom Reset	Reset of peak / bottom value (flow rate)
190	Integrated flow Reset	Reset of the accumulated flow value

- Device access lock parameter (index 12)

The contents are as follows.

Data type: 16 bit Record

Value	Contents
0	Key lock release, DS unlock (Initial value)
2	Key lock release, DS lock
8	Key lock, DS unlock
10	Key lock, DS lock

[Key lock]

This function prevents the user from physically changing the setting of the flow switch (button operation is not accepted).

Even when key lock function is activated, settings can be changed by IO-Link communication.

Restoration by data storage (overwriting parameter data) can be performed.

[Lock data storage (DS lock)]

Locking "Data storage" will invalidate the data storage function of the flow switch.

In this case, access will be denied for backup and restoration of data storage.

- Device state parameters (index 36)

Readable device states are as follows.

Data type: 8 bit UInteger

Value	State definition	Description
0	Normal operation	-
1	Maintenance inspection required	Not available
2	Outside specification range	Outside the flow measurement range Below the flow measurement range
3	Function check	Not available
4	Failure	Internal failure of digital flow switch

- Device detail status parameters (index 37)

Detailed event contents of readable device status are as follows.

Array	Event content	Event classification		Event code
		Definition	Value	
1	Internal failure of digital flow switch	Error	0xF4	0x8D03
2	Internal failure of digital flow switch	Error	0xF4	0x8D04
3	Internal failure of digital flow switch	Error	0xF4	0x8D05
4	Internal failure of digital flow switch	Error	0xF4	0x8D01
5	Internal failure of digital flow switch	Error	0xF4	0x8D06
6	Internal failure of digital flow switch	Error	0xF4	0x8D08
7	OUT2 over current error	Error	0xF4	0x8CC0
8	Outside the accumulated flow measurement	warning	0xE4	0x8D80
9	Outside the instantaneous flow measurement	warning	0xF4	0x8C10
10	Below the instantaneous flow measurement	warning	0xE4	0x8C30
11	Test event A	warning	0xE4	0x8CA0
12	Test event B	warning	0xE4	0x8CA1
13	Data storage upload request	notification	0x54	0xFF91

●Product individual parameters

Index		Sub index	Access ^{*1}	Parameter	Data type ^{*2}	Initial value	Data storage ^{*3}	Set value	Remarks					
dec	hex													
160	00A0	0	R	Complete product number	C32	ALL 0x00	N	Arbitrary data						
1000	0x03E8	0	R/W	Unit (Unit setting)	U8	0	Y	0: L (L/min) 1: Ft (cfm)	When the unit selection function is not included, a read/write to an un-selectable item is rejected.					
1010	0x03F2	0	R/W	CoL (Selection of display colour)	U8	2	Y	0: rEd (Constantly red) 1: Grn (Constantly green) 2: 1SoG (OUT1 turns green at ON) 3: 1Sor (OUT1 turns red at ON) 4: 2SoG (OUT2 turns green at ON) 5: 2Sor (OUT2 turns green at ON)	Setting of display colour					
1020	0x03FC	0	R/W	NorP (Selection of switch output PNP/NPN)	U8	1	Y	0: NPN 1: PNP	Setting of switch output specification					
1030	0x0406	0	R/W	i_o (select switch output/ external input)	U8	1	Y	0: oUt (switch output) 1: in (external input)	Setting OUT2 output specification setting					
1070	0x042E	0	R/W	rEF (reference condition)	U8	1	Y	0: Std (Standard condition) 1: PNP (reference condition)	Measurement Units criteria setting					
1210	0x04BA	1	R/W	OUT1 setting oUt1 (Selection output mode)	U8	0	Y	0: HYS (Hysteresis) 1: Wind (Window comparator) 2: AC (Accumulated output) 3: PLS (Accumulated pulse) 4: Err (Error output) 5: oFF (Output OFF)	Setting of OUT1 output mode					
		2	R/W							1ot (Selection of output type)	U8	0	Y	0: 1_P (Normal output) 1: 1_n (Reverse output)
1220	0x04C4	1	R/W	Set OUT1 switch point.	S16	2000	Y	Setting range -200 to 4200	Setting of OUT1 output set value (Hysteresis)					
		2	R/W							H_1 (Setting of OUT1 hysteresis)	200	Y	Setting range 0 to 4400	Setting of OUT1 hysteresis (Hysteresis)
		3	R/W							P1L(n1L) (Lower limit of window comparator)	1200	Y	Setting range -200 to 4200	Setting of OUT1 output set value (Lower limit of window comparator)
		4	R/W							P1H(n1H) (Upper limit of window comparator)	2400	Y	Setting range -200 to 4200	Setting of OUT1 output set value (Upper limit of window comparator)
		5	R/W							WH1 (Window comparator hysteresis)	400	Y	Setting range 0 to 2200	Setting of OUT1 hysteresis (Window comparator)
		6	R/W							dtH1 (Delay time at ON)	0	Y	Setting range 0 to 6000	Setting of OUT1 delay time at ON 10 ms increment
		7	R/W							dtL1 (Delay time at OFF)	0	Y		Setting of OUT1 delay time at OFF 10 ms increment

●Product individual parameters (continued)

Index		Sub index	Access ^{*1}	Parameter	Data type ^{*2}	Initial value	Data storage ^{*3}	Set value	Remarks	
dec	hex									
1300	0x0514	1	R/W	OUT1 accumulated flow setting	AC1_L (Mantissa L)	U16	0	Y	Setting range 0 to 9999	Setting of OUT1 mantissa Unit: when "L" is selected
		2	R/W		AC1_L (Index L)	U16	0	Y	Setting range 0 to 6	Setting of OUT1 index Unit: when "L" is selected
1310	0x051E	1	R/W	OUT1 accumulated flow setting	AC1_L (Mantissa Ft ³)	U16	0	Y	Setting range 0 to 9999	Setting of OUT1 mantissa Unit: when "Ft" is selected
		2	R/W		AC1_L (Index Ft ³)	U16	0	Y	Setting range 0 to 6	Setting of OUT1 index Unit: when "Ft" is selected
1410	0x0582	1	R/W	OUT2 setting	oUt2 (Selection output mode)	U8	0	Y	0: HYS (Hysteresis) 1: Wind (window comparator) 2: AC (Accumulated output) 3: PLS (Accumulated pulse) 4: Err (Error output) 5: oFF (Output OFF)	Setting of OUT2 output mode
		2	R/W		2ot (Selection of output type)	U8	0	Y	0: 2_P (Normal output) 1: 2_n (Reverse output)	Setting of OUT2 output normal and reserved output.
1420	0x058C	1	R/W	OUT2 switch point.	P_2 (n_2) (Selection of output set value)	S16	2000	Y	Setting range -200 to 4200	Setting of OUT2 output set value (Hysteresis)
		2	R/W		H_2 (Setting of OUT2 hysteresis)	S16	200	Y	Setting range 0 to 4400	Setting of OUT2 hysteresis (Hysteresis)
		3	R/W		P2L (n2L) (Lower limit of window comparator)	S16	1200	Y	Setting range -200 to 4200	Setting of OUT2 output set value (Lower limit of window comparator)
		4	R/W		P2H (n2H) (Upper limit of window comparator)	S16	2400	Y	Setting range -200 to 4200	Setting of OUT2 output set value (Upper limit of window comparator)
		5	R/W		WH2 (Window comparator hysteresis)	S16	400	Y	Setting range 0 to 2200	Setting of OUT2 hysteresis (Window comparator)
		6	R/W		dtH2 (Delay time at ON)	S16	0	Y	Setting range 0 to 6000	Setting of OUT2 delay time at ON 10 ms increment
		7	R/W		dtL2 (Delay time at OFF)	S16	0	Y		Setting of OUT2 delay time at OFF 10 ms increment
1500	0x05DC	1	R/W	OUT2 accumulated flow setting	AC2_L (Mantissa L)	U16	0	Y	Setting range 0 to 9999	Setting of OUT2 mantissa Unit: when "L" is selected
		2	R/W		AC2_L (Index L)	U16	0	Y	Setting range 0 to 6	Setting of OUT2 index Unit: when "L" is selected
1510	0x05E6	1	R/W	OUT2 accumulated flow setting	AC2_L (Mantissa Ft ³)	U16	0	Y	Setting range 0 to 9999	Setting of OUT2 mantissa Unit: when "Ft" is selected
		2	R/W		AC2_L (Index Ft ³)	U16	0	Y	Setting range 0 to 6	Setting of OUT2 index Unit: when "Ft" is selected
1600	0x0640	0	R/W	AC (Setting of the accumulated flow output direction)	U8	0	Y	0: Add (Addition) 1: dEC1 (Subtraction OUT1) 2: dEC2 (Subtraction OUT2)	Setting of the accumulated flow output direction	
1030	0x0406	0	R/W	FiL (Digital filter)	U8	3	Y	0: 0.05 sec 1: 0.1 sec 2: 0.5 sec 3: 1.0 sec 4: 2.0 sec 5: 5.0 sec	Setting of digital filter	

●Product individual parameters (continued)

Index		Sub index	Access ^{*1}	Parameter		Data type ^{*2}	Initial value	Data storage ^{*3}	Set value	Remarks
dec	hex									
2000	0x07D0	1	R/W	Sub screen	Sub (Setting of lower level screen)	U8	0	Y	0: dEF (Default) 1: LinE (Line name) 2: oFF (Display OFF)	
		2	R/W		dEF (During dEF setting Selection of display item)	U8	0	Y	Refer to "Selection of display items" when dEF is set. (page 83)	
2030	0x07EE	0	R/W	Cut (Zero cut-off setting)		U8	1	Y	Setting range 0 to 10	1.0% increments
2040	0x07F8	0	R/W	inP (External input setting)		U8	1	Y	0: oFF 1: rAC (Accumulated value reset) 2: rPb (Reset peak/bottom)	
2100	0x0834	0	R/W	AoUt (Setting of analogue output)		U8	0	Y	0: 1-5 (1 to 5 V) 1: 0-10 (0 to 10 V)	Setting of analogue output (Voltage output type only)
2110	0x083E	1	R/W	FrEE (Analogue free range)		U8	0	Y	0: on 1: oFF	
		2	R/W	F_H (Set value)		U16	4000	Y	Setting range 400 to 4200	
2200	0x0514	0	R/W	SAVE (Accumulated flow value hold setting)		U8	0	Y	0: oFF (Not held) 1: 2.0 min 2: 5.0 min	
2400	0x0708	0	R/W	diSP (Display OFF setting)		U8	0	Y	0: on 1: oFF	
2410	0x096A	1	R/W	Security code	Pin (Security code Used/Not used)	U8	0	Y	0: unused 1: use	
		2	R/W		PinCode (Security code setting)	U16	0	Y	Setting range 0 to 999	
2420	0x0974	1	R/W	Line name letter	1st letter (left end)	U8	0	Y	Refer to "[Line name: communication data". (page 84)	
		2	R/W		2nd letter	U8	0	Y		
		3	R/W		3rd letter	U8	0	Y		
		4	R/W		4th letter	U8	0	Y		
		5	R/W		5th letter	U8	0	Y		
		6	R/W		6th letter	U8	0	Y		
		7	R/W		7th letter	U8	0	Y		
		8	R/W		8th letter	U8	0	Y		
		9	R/W		9th letter (right end)	U8	0	Y		
2430	0x097E	1	R/W	Line name dot	1 st dot (left end)	U8	0	Y	0: oFF (dot OFF) 1: on (dot ON)	
		2	R/W		2nd dot	U8	0	Y		
		3	R/W		3rd dot	U8	0	Y		
		4	R/W		4th dot	U8	0	Y		
		5	R/W		5th dot	U8	0	Y		
		6	R/W		6th dot	U8	0	Y		
		7	R/W		7th dot	U8	0	Y		
		8	R/W		8th dot	U8	0	Y		
		9	R/W		9th. dot (right end)	U8	0	Y		

●Product individual parameters (continued)

Index		Sub index	Access *1	Parameter	Data type *2	Initial value	Data storage *3	Set value	Remarks	
dec	hex									
7000	0x1B58	0	W	Communication OUT output test	OUT Test	U8	-	N	0: Normal output 1: Fixed output	The PD becomes 1 when a fixed output has been received.
7010	0x1B62	0	W		Toggle (Toggle output)	U8	-	N	0: Measured value 16: OUT1 17: OUT2 80: Analogue output 224: Diagnostic bit 255: Error bit	Connected with hardware output
7100	0x1BBC	0	R	Measurement related	Analogue output value	U8	0	Y	Voltage output: 0.1V increments Current output: 1mA increments	
8000	0x1F40	0	R		Inclination of flow rate PD a	F32	-	N	Refer to "Inclination and intercept". (page 75)	
8010	0x1F4A	0	R		Flow rate PD intercept b	F32	-	N	Refer to "Inclination and intercept". (page 75)	
8020	0x1F54	0	R		Flow peak value	S16	0	N	-200 to 4200	The conversion method from the communication value to the actual measurement value is the same as the method for process data.
8030	0x1F5E	0	R		Flow bottom value	S16	0	N		
8040	0x1F68	0	R		Accumulated mantissa	F32	-	N	0 to 9999	Accumulated PD × Accumulated value conversion factor = Current accumulated flow value
		0	R		Accumulated index	F32	-	N	0 to 6	

*1: "R" means Read and "W" means Write.

*2: Refer to the table below for the symbol.

Symbol	Data type (IO-Link standard)	Data length Bit [byte]	Description
U8	UIntegerT	8 [1]	Unsigned integer
U16		16 [2]	
S16	IntegerT	16 [2]	Signed integer
F32	Float32T	32 [4]	Floating point number
C32	StringT	32 [4]	String

*3: "Y" indicates that the parameter setting data is saved to the master, and "N" indicates that the parameter is not saved.

*4: Read/write to un-selectable items will be rejected depending on the product No.

[dEF Selection of display items during standard setting]

Value	Setting content		Supplemental information	
0	OUT1	HYS mode set value	When the value which does not match the OUT* output mode setting is written, acknowledgment is sent	
1		HYS mode hysteresis		
2		Wind mode lower side set value		
3		Wind mode upper side set value		
4		Wind mode hysteresis		
5		Accumulated output mode		
6		Accumulated pluse output mode		
7		Err mode		
8		oFF mode		
9	OUT2	HYS mode set value		
10		HYS mode hysteresis		
11		Wind mode lower side set value		
12		Wind mode upper side set value		
13		Wind mode hysteresis		
14		Accumulated output mode		
15		Accumulated pluse output mode		
16		Err mode		
17		oFF mode		
18	Flow bottom value			
19	Flow peak value			
20	Accumulated flow value			
21	Switch output mode/communication mode display		SIO mode/SDCI mode display	

[Line name communication data]

Value (16 hex number)		00	01	02	03	04	05	06	07	08	09	0A	0B	0C	0D	0E	0F
Display letter	7seg																
	11seg																
Value (16 hex number)		10	11	12	13	14	15	16	17	18	19	1A	1B	1C	1D	1E	1F
Display letter	7seg	/							/		/						
	11seg																
Value (16 hex number)		20	21	22	23	24	25	26	27	28	29	2A	2B	2C	2D	2E	2F
Display letter	7seg								/	/	/	/	/	/	/	/	
	11seg																
Supplementary information	When is displayed, a reject response will be sent.																

Troubleshooting

If an operation failure of the product occurs, please confirm the cause of the failure from the following table. If a cause applicable to the failure cannot be identified and normal operation can be recovered by replacement with a new product, this indicates that the product itself was faulty. Problems with the product may be due to the operating environment (installation etc). Please consult SMC.

Cross-reference for troubleshooting

Fault		Possible cause	Countermeasures
Display	No display.	Incorrect wiring.	Correct the wiring.
		Loose connector.	Connect the connector.
	The display is unstable.	Foreign matter in the sensor.	Install a filter or mist separator on the IN side if there is a risk of foreign matter entering the product. If there is foreign matter on the mesh, remove it completely, taking care not to damage the product.
		The piping is connected in the wrong direction.	Mount the product so that the flow direction is the same as the arrow indicated on the side of the body or the product label.
		Pulsation in the flow.	It is possible that pulsation is generated due to the fluctuation of the supply pressure or the characteristics of the compressor or pump used as the pressure source. Change to a pressure source with less fluctuation or install a tank which reduces the pressure fluctuation.
		Air leakage.	Correct the piping.
	Incorrect display.	Foreign matter in the sensor.	Install a filter or mist separator on the IN side if there is a risk of foreign matter entering the product. If there is foreign matter on the mesh, remove it completely, taking care not to damage the product.
		The piping is connected in the wrong direction.	Mount the product so that the flow direction is the same as the arrow indicated on the side of the body or the product label.
		Incorrect units selected. *	Select the correct unit using the unit selection function.
		Air leakage.	Correct the piping.

*: Product with unit selection function.

	Fault	Possible cause	Countermeasures
Output	No output.	Incorrect wiring.	Correct the wiring.
		Loose connector.	Connect the connector.
	Output is unstable.	Foreign matter in the sensor.	Install a filter or mist separator on the IN side if there is a risk of foreign matter entering the product. If there is foreign matter on the mesh, remove it completely, taking care not to damage the product.
		The piping is connected in the wrong direction.	Mount the product so that the flow direction is the same as the arrow indicated on the side of the body or the product label.
		Pulsation in the flow.	It is possible that pulsation is generated due to the fluctuation of the supply pressure or the characteristics of the compressor or pump used as the pressure source. Change to a pressure source with less fluctuation or install a tank which reduces the pressure fluctuation.
		Air leakage.	Correct the piping.
	Hysteresis is too small.	Increase the hysteresis.	
Button	The buttons do not operate.	Key lock mode is activated.	Unlock the keys. (page 69)
External input	The external input is not accepted (no reaction). *	Incorrect wiring.	Correct the wiring.
		The input time is too short.	When the external input is applied, the input line must be connected to GND for a minimum of 30 msec.
		Input interval is too short.	To input signals successively, wait for at least 1 second before inputting the next signal.

*: Product with external input function.



○ Troubleshooting list (IO-Link communication)

Problem	Description	Problem possible causes	Investigation method	Countermeasures
IO-Link indicator light ☑: OFF	-	incorrect wiring	Check the connection of the connector.	Correct the cable wiring.
		Power supply error from the IO-Link master	Check the power supply voltage from the IO-Link master.	Supply 18 to 30 VDC to the IO-Link master.
IO-Link indicator light ☑: Flashing	Mode ***	Communication is not established. IO-Link wiring failure	Check the connection and cable condition of the IO-Link cable.	Additionally tighten the IO-Link cable. (Replace the cable if it is broken.)
IO-Link indicator light ☑: Flashing	Er 15 V 1.0	IO-Link master and product version are not matched.	Check the IO-Link version of the master and device.	Align the master IO-Link version to the device. *1
	Mode Start	Communication mode is not transferred to the Operation mode.	Check the setting of the data storage access lock and data storage backup level of the master.	Release the data storage access lock. Or deactivate the setting of the data storage backup level of the master port.
	Mode Lck	Backup and restore required during data storage lock	Check the data storage lock.	Release the data storage lock.
Data is swapped by byte.	-	Program data assignment is incorrect.	Check that the Endian type on the master upper level communication transmission format is Big Endian type or Little Endian type.	Assign the program data based on the Endian type of the transmission format of the master upper level communication. Or set to the master byte swap setting. (Refer to page 73 for the Endian type of the upper level communication)

*1: When the product is connected to the master with version "V1.0", error Er15 is generated.

○Error indication function

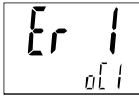
This function is to display error location and content when a problem or error has occurred.

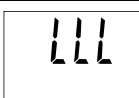
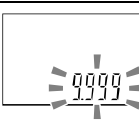
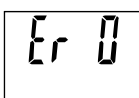
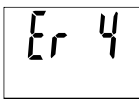
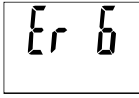
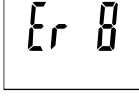
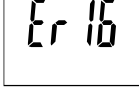
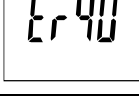
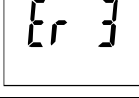
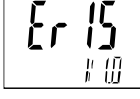
Error name	Error display	Description	Measures
OUT1 over current error		A load current applied to the switch output has exceeded the max. value (OUT1).	Turn the power off and remove the cause of the over current. Then turn the power on again.
OUT2 over current error		A load current applied to the switch output has exceeded the max. value (OUT2).	
Instantaneous flow error		The flow has exceeded the upper limit of the flow display range.	Reduce the flow.
		Fluid is flowing in the reverse direction by at least -5% of the maximum rated flow value.	Connect the fluid flow in the correct direction.
Excessive accumulated flow		The accumulated flow range is exceeded. (The decimal point position changes depending on the flow range.)	Reset the accumulated flow once. (Press the SET and DOWN button for 1 second or longer.)
System error	     	Displayed if an internal data error has occurred.	Turn the power off and turn it on again. If the failure cannot be solved, contact SMC for repair.
Zero clear error		During zero clear operation, the flow rate of greater than $\pm 5\%$ F.S. is applied.	Retry the zero clear operation without fluid.
Version does not match		Version of master and IO-Link does not match.	Align the master IO-Link version to the device.

If the error cannot be reset after the above measures are taken, or errors other than above are displayed, please contact SMC.

Specifications

Model		PFMC7501	PFMC7102	PFMC7202	
Fluid	Applicable fluid	Air, N ₂ (Air quality: ISO8573-1 1.1.2 to 1.6.2)			
	Fluid temperature range	0 to 50 °C			
Flow	Detecting method	Heating type sensor			
	Rated flow range	5 to 500 L/min	10 to 1000 L/min	20 to 2000 L/min	
	Set flow rate range	Instantaneous flow	5 to 525 L/min	10 to 1050 L/min	20 to 2100 L/min
		Accumulated flow	0 to 999,999,990 L		
	Min. setting unit	Instantaneous flow	1 L/min		
		Accumulated flow	10 L		
	Accumulated volume per pulse (Pulse width = 50 msec.)	1 L/pulse	10 L/pulse		
Accumulated value hold *1	Select from 2 minutes or 5 minutes				
Pressure	Rated pressure range	0 to 0.8 MPa			
	Proof pressure	1.2 MPa			
	Pressure loss	Refer to the pressure loss graph			
	Pressure characteristics *2	±5%F.S. (0 to 0.8 MPa, 0.6 MPa standard)			
Electrical	Power supply voltage	Used as switch output device	12 to 24 VDC ±10%		
		Used as IO-Link device	18 to 30 VDC ±10%		
	Current consumption	55 mA or less			
	Protection	Polarity protection			
Accuracy	Display accuracy	±3%F.S.			
	Analogue output accuracy	±3%F.S.			
	Repeatability	±1%F.S. (±2%F.S. when response time is set to 0.05 second)			
	Temperature characteristics	±5%F.S. (0 to 50 °C, 25 °C standard)			
Switch output	Output type	Select from NPN or PNP open collector output			
	Output mode	Select from Hysteresis mode, Window comparator mode, Accumulated output mode, Accumulated pulse output mode, Error output or Switch OFF			
	Switch operation	Select from Normal output or Reversed output			
	Max. load current	80 mA			
	Maxi. applied voltage	30 VDC (at NPN output)			
	Internal voltage drop (Residual voltage)	1.5 V or less (Load current 80 mA)			
	Digital filter *3	Select from 0.05 s, 0.5 s, 0.15 s, 1.0 s, 2.0 s or 5.0 s			
	Hysteresis *4	Variable			
	Protection	Short circuit protection			
Delay time *5	3.4 ms or less Variable at 0 to 60 s/0.01 step				

Model		PFMC7501	PFMC7102	PFMC7202	
Analogue output *6	Output type	Voltage output: 1 to 5 VDC, 0 to 10 VDC (only when the power supply voltage is 24 VDC) Current output: 4 to 20 mA (Refer to analogue output graph)			
	Impedance	Voltage output	Output impedance approx. 1 kΩ		
		Current output	Maxi. load impedance: 600 Ω at 24 VDC 300 Ω at 12 VDC Mini. load impedance: 50 Ω		
	Response time *7		Linked with the response time of the switch output.		
External input *8	External input specification	Input voltage: NPN type: 0.4 V or less (reed or solid state type) PNP type: DC(+)-1 V or more Input time: 30 msec. or longer			
	Input mode	Accumulated flow external reset or peak/bottom hold value			
Display	Reference condition *9	Select from Normal condition or Standard condition			
	Unit *10	Instantaneous flow	L/min, cfm (ft ³ /min)		
		Accumulated flow	L, ft ³		
	Displayable range	Instantaneous flow	-25 to 525 L/min (Displays [0] when the value is between -4 and 4.)	-50 to 1050 L/min (Displays [0] when the value is between -9 and 9.)	-100 to 2100 L/min (Displays [0] when the value is between -19 and 19.)
		Accumulated flow	0 to 999,999,999 L		
	Minimum setting unit	Instantaneous flow	1 L/min		
		Accumulated flow	10 L		
	Display	LCD with 2 displays (Main display and Sub display) Colour: Red and green for main display, White for sub display Digits: 4 digits 7 segments for main display, 9 digits 11 segments for sub display (7 segment for 5th digits)			
Indicator LED	LED is ON when switch output is ON (OUT1/OUT2: Orange)				
Environmental	Enclosure	IP65			
	Withstand voltage	250 VAC for 1 minute between live parts and case			
	Insulation resistance	2 MΩ or more between live parts and case (with 50 VDC megger)			
	Operating temperature range	Operation: 0 to 50 °C, Storage: -10 to 60 °C (No condensation or freezing)			
	Operating humidity range	Operation, Storage: 35 to 85%RH (No condensation or freezing)			
Standards		CE marked (EMC directive, RoHS directive), CSA			
Piping port sizes		Rc1/2, NPT1/2, G1/2		Rc3/4, NPT3/4, G3/4	
Fluid contact materials		SUS304, PPS, Aluminum alloy, HNBR, Si, Au, GE4F			
Weight	Piping port sizes	Rc screw, NPT screw	160 g	240 g	
		G screw	170 g	245 g	
	Lead wire	+80 g			
	Bracket	+25 g		+30 g	

Model	PFMC7501	PFMC7102	PFMC7202
Communication (During IO-Link mode)	IO-Link type	Device	
	IO-Link version	V1.1	
	Communication speed	COM2 (38.4 kbps)	
	Min. cycle time	3.4 ms	
	Process data length	Input Data: 4 byte, Output Data: 0 byte	
	On request data communication	Available	
	Data storage function	Available	
	Event function	Available	
	Vendor ID	131 (0x0083)	
	Device ID *11	Refer to direct parameters page 1 (page 76)	

*1: When using the accumulated value hold function, calculate the product life from the operating conditions, and use the product within its life. The maximum access limit of the memory device is 1 million cycles. If the product is operated 24 hours per day, the product life will be as follows:

- Data memorized every 5 minutes --- 5 minutes x 3.7 million times = 5 million minutes = 35 years
- Data memorized every 2 minutes --- 2 minutes x 3.7 million times = 2 million minutes = 14 years

If the accumulated flow external reset is also repeatedly used, the product life will be shorter.

*2: Do not release the OUT side piping port of the product directly to the atmosphere without connecting piping. If the product is used with the piping port open to atmosphere, accuracy may vary.

*3: The response time is when the set value is 90% in relation to the step input. (The value will be 7 s for the temperature sensor output.)

*4: If the flow fluctuates around the set value, the hysteresis must be set to more than the fluctuation width. Otherwise, chattering will occur.

*5: Digital filter value is not included.

*6: This function is available for models with analogue output.

*7: The time from when the flow is changed as a step input (when the flow rate changes from 0 to the maximum flow instantaneously) until the analogue output reaches 90% of the rated flow rate.

*8: This function is available for models with external input.

*9: The flow rate given in the specification is the value at standard condition (ANR).

*10: Setting is only possible for models with the unit selection function.

*11: The Device ID varies depending on the product No.

Cable specifications: Lead wire with M8 connector (ZS-40-A)

Item	Specifications	
Conductor	Nominal cross section	AWG23
	Outside diameter	Approx. 0.7 mm
Insulator	Material	Heat resistant PVC
	Outside diameter	Approx. 1.1 mm
	Colorurs	Brown, White, Black, Blue
Sheath	Material	Heat and oil resistant PVC
Finished outside diameter		φ4

■ Characteristics data

● Flow rate/ Analogue output

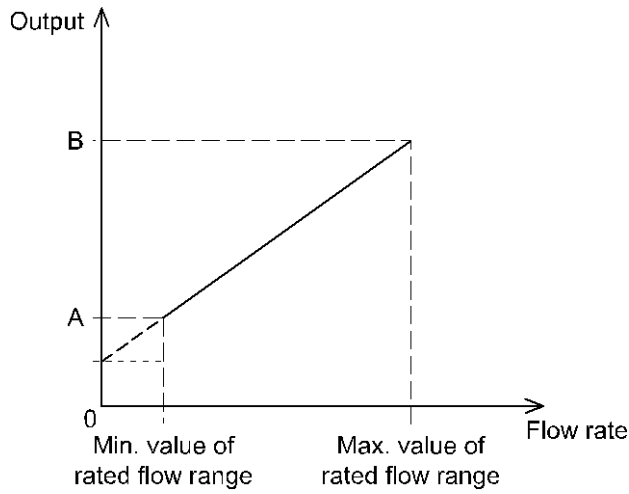

	0 L/min	A	B
Voltage output (1 to 5 V) *1	1 V	1.04 V	5 V
Current output *1	4 mA	4.16 mA	20 mA

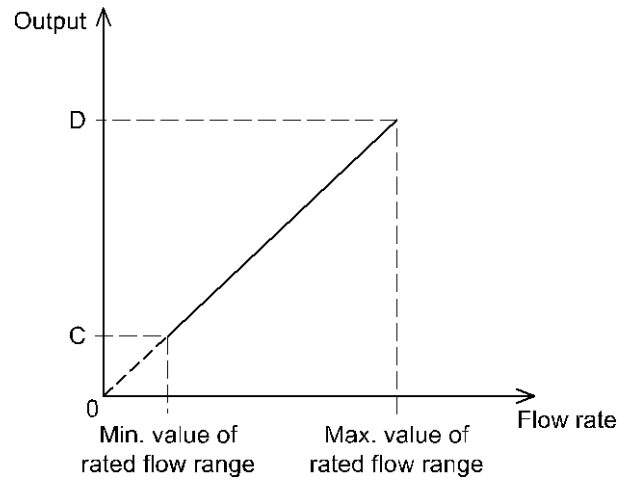

	0 L/min	C	D
Voltage output (0 to 10 V) *1, *2	0 V	0.1 V	10 V

Models	Minimum value of rated flow range	Maximum value of rated flow range
PFMC7501	5 L/min	500 L/min
PFMC7102	10 L/min	1000 L/min
PFMC7202	20 L/min	2000 L/min

*1: Analogue output accuracy is within $\pm 3\%$ F.S.

*2: Set the current to the analogue output from the connected equipment to 20 μ A or less when selecting 0 to 10 V.
When 20 μ A or more current flows, it is possible that the accuracy is not satisfied in the area at 0.5 V or lower.

● Pressure loss

PFMB7501 (500 L/min)

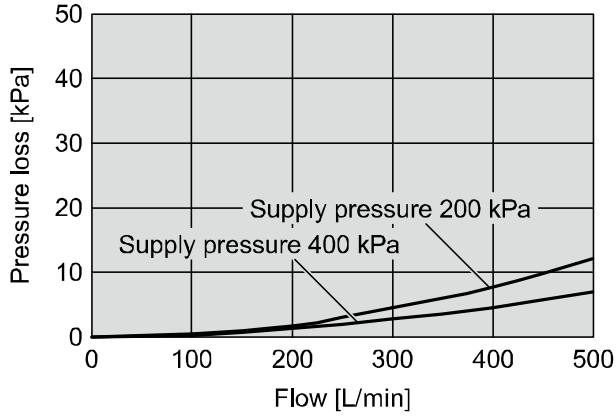

PFMB7102 (1000 L/min)

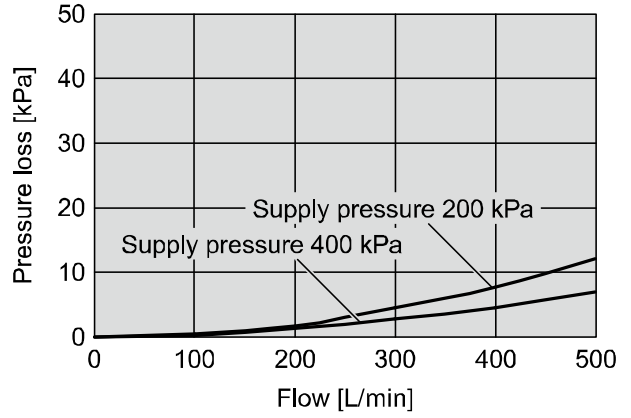

PFMB7202 (2000 L/min)

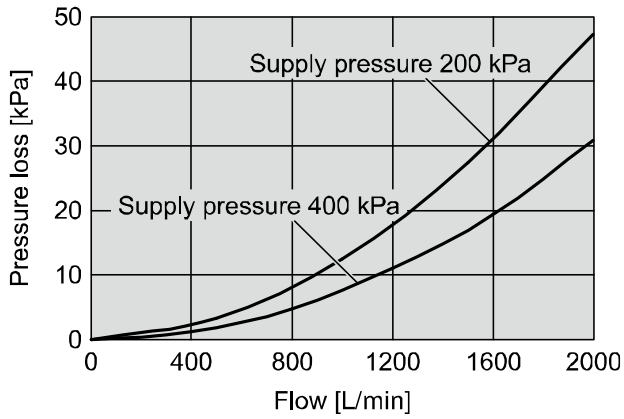

- Straight inlet piping length and accuracy (reference value)
 - The smaller the piping size, the more the product is affected by the straight piping length.
 - The smaller the flow rate, the less the product is affected by the straight piping length.
 - The straight piping length shall be 8 cm or longer in order to maintain $\pm 3\%$ F.S. of the specification.

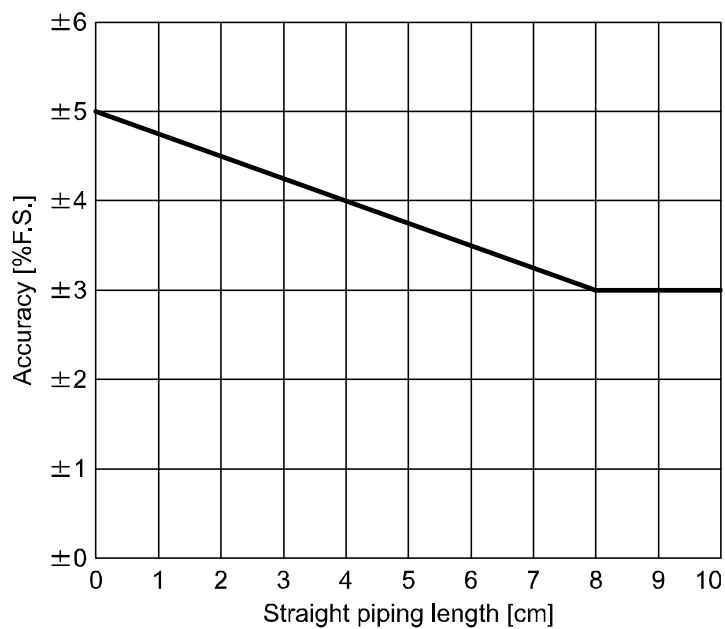
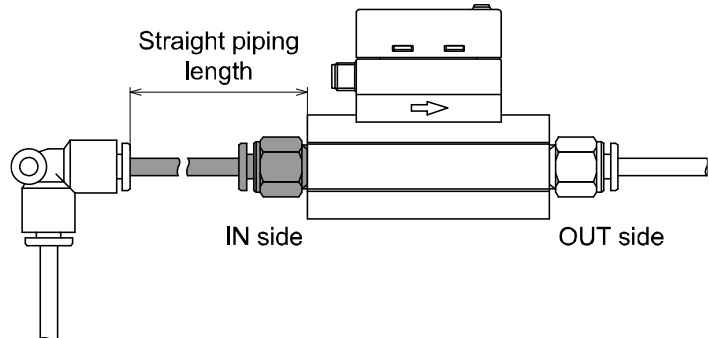

■Dimensions

PFMC7501/7102/7202

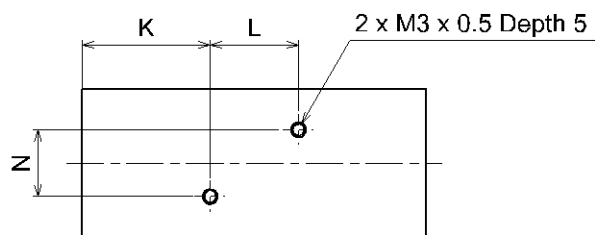
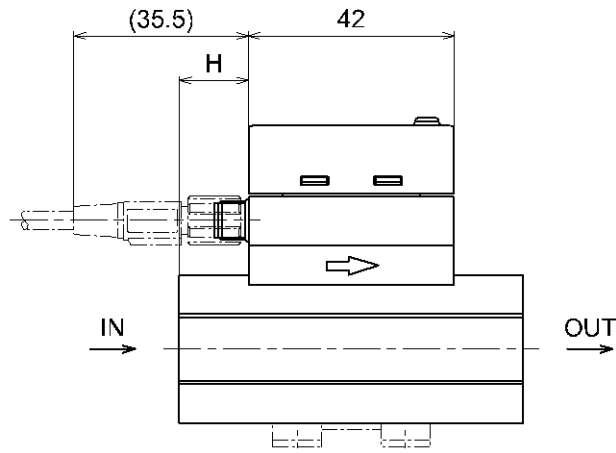
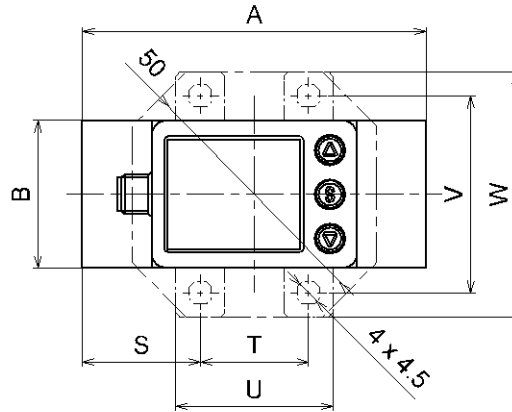
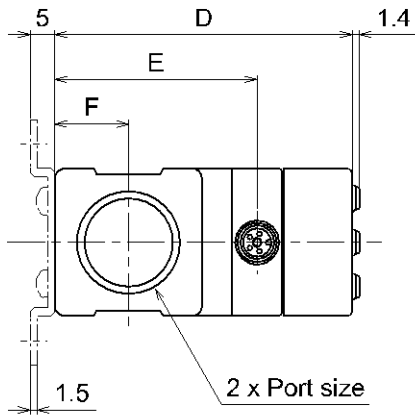

Model	Symbol	Piping port size	A	B	D	E	F	H	K	L	N
PFMC7501/7102		Rc1/2, NPT1/2	70	30	60.6	41.2	15	14	26	18	13.6
PFMC7202		Rc3/4, NPT3/4, G3/4	90	35	66.1	46.7	17.5	24	31	28	16.8
PFMC7501/7102		G1/2	76	30	60.6	41.2	15	14	26	18	13.6

Model	Symbol	Bracket dimensions				
		S	T	U	V	W
PFMC7501/7102		24	22	32	40	50
PFMC7202		30	30	42	48	58

Lead wire with M8 connector (ZS-40-A)

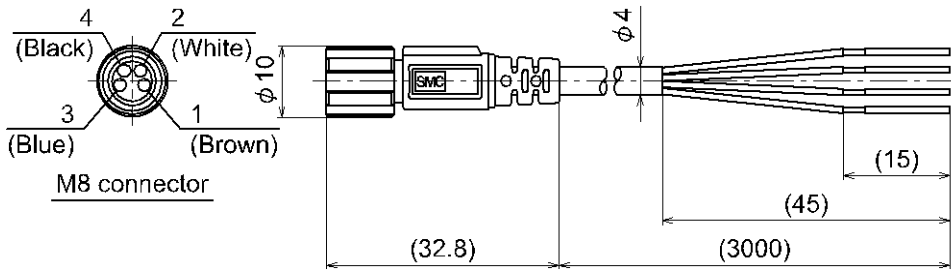

M12-M8 conversion lead wire (ZS-40-M12M8-A)

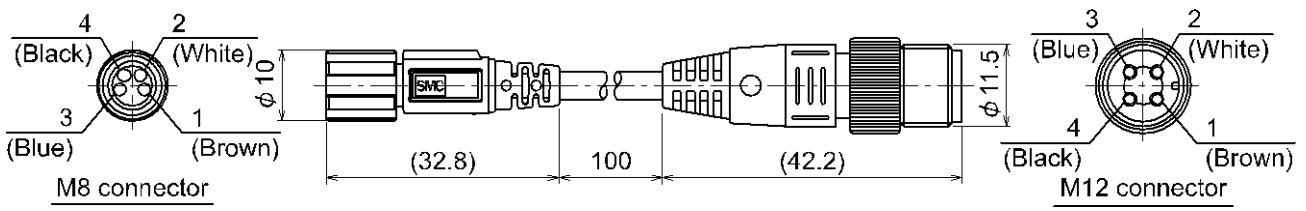

Revision history

SMC Corporation

4-14-1, Sotokanda, Chiyoda-ku, Tokyo 101-0021 JAPAN

Tel: + 81 3 5207 8249 Fax: +81 3 5298 5362

URL <https://www.smcworld.com>

Note: Specifications are subject to change without prior notice and any obligation on the part of the manufacturer.
© 2020 SMC Corporation All Rights Reserved

