



Operation Manual

PRODUCT NAME

Electrostatic Sensor Monitor

MODEL/ Series

IZE11

SMC Corporation



Table of Contents

Safety Instructions	2
Model Identification and How to Order	7
Summary of Product parts	8
Mounting and Installation	10
Installation	10
Wiring	11
Setting	14
Measurement mode	15
Function selection mode	18
Default setting	18
F0 Select connect sensor	19
F1 Operation of OUT1	20
F2 Operation of OUT2	22
F3 Measured distance setting	22
F4 Setting of switch output response time	23
F5 Select analog output filter	24
F6 Setting of security code	25
F98 Setting of all functions	26
F99 Reset to the default setting	27
Other settings	28
Error Indication Function	31
Specification	32
Specifications	32
Dimensions	34

Safety Instructions

These safety instructions are intended to prevent hazardous situations and/or equipment damage. These instructions indicate the level of potential hazard with the labels of "Caution", "Warning" or "Danger". They are all important notes for safety and must be followed in addition to International standards (ISO/IEC) *1) and other safety regulations.

- *1) ISO 4414: Pneumatic fluid power -- General rules relating to systems.
- ISO 4413: Hydraulic fluid power -- General rules relating to systems.
- IEC 60204-1: Safety of machinery -- Electrical equipment of machines. (Part 1: General requirements)
- ISO 10218-1992: Manipulating industrial robots -Safety.
- etc.

 Caution :	CAUTION indicates a hazard with a low level of risk which, if not avoided, could result in minor or moderate injury.
 Warning :	WARNING indicates a hazard with a medium level of risk which, if not avoided, could result in death or serious injury.
 Danger :	DANGER indicates a hazard with a high level of risk which, if not avoided, will result in death or serious injury.

Warning

1. The compatibility of the product is the responsibility of the person who designs the equipment or decides its specifications.

Since the product specified here is used under various operating conditions, its compatibility with specific equipment must be decided by the person who designs the equipment or decides its specifications based on necessary analysis and test results. The expected performance and safety assurance of the equipment will be the responsibility of the person who has determined its compatibility with the product. This person should also continuously review all specifications of the product referring to its latest catalogue information, with a view to giving due consideration to any possibility of equipment failure when configuring the equipment.

2. Only personnel with appropriate training should operate machinery and equipment.

The product specified here may become unsafe if handled incorrectly. The assembly, operation and maintenance of machines or equipment including our products must be performed by an operator who is appropriately trained and experienced.

3. Do not service or attempt to remove product and machinery/equipment until safety is confirmed.

1. The inspection and maintenance of machinery/equipment should only be performed after measures to prevent falling or runaway of the driven objects have been confirmed.
2. When the product is to be removed, confirm that the safety measures as mentioned above are implemented and the power from any appropriate source is cut, and read and understand the specific product precautions of all relevant products carefully.
3. Before machinery/equipment is restarted, take measures to prevent unexpected operation and malfunction.

4. Contact SMC beforehand and take special consideration of safety measures if the product is to be used in any of the following conditions.

1. Conditions and environments outside of the given specifications, or use outdoors or in a place exposed to direct sunlight.
2. Installation on equipment in conjunction with atomic energy, railways, air navigation, space, shipping, vehicles, military, medical treatment, combustion and recreation, or equipment in contact with food and beverages, emergency stop circuits, clutch and brake circuits in press applications, safety equipment or other applications unsuitable for the standard specifications described in the product catalogue.
3. An application which could have negative effects on people, property, or animals requiring special safety analysis.
4. Use in an interlock circuit, which requires the provision of double interlock for possible failure by using a mechanical protective function, and periodical checks to confirm proper operation.

Caution

The product is provided for use in manufacturing industries.

The product herein described is basically provided for peaceful use in manufacturing industries. If considering using the product in other industries, consult SMC beforehand and exchange specifications or a contract if necessary.
If anything is unclear, contact your nearest sales branch.

Limited warranty and Disclaimer/Compliance Requirements

The product used is subject to the following "Limited warranty and Disclaimer" and "Compliance Requirements".

Read and accept them before using the product.

Limited warranty and Disclaimer

1. The warranty period of the product is 1 year in service or 1.5 years after the product is delivered, whichever is first. *2)
Also, the product may have specified durability, running distance or replacement parts. Please consult your nearest sales branch.
2. For any failure or damage reported within the warranty period which is clearly our responsibility, a replacement product or necessary parts will be provided.
This limited warranty applies only to our product independently, and not to any other damage incurred due to the failure of the product.
3. Prior to using SMC products, please read and understand the warranty terms and disclaimers noted in the specified catalogue for the particular products.

*2) Vacuum pads are excluded from this 1 year warranty.

A vacuum pad is a consumable part, so it is warranted for a year after it is delivered.

Also, even within the warranty period, the wear of a product due to the use of the vacuum pad or failure due to the deterioration of rubber material are not covered by the limited warranty.

Compliance Requirements

1. The use of SMC products with production equipment for the manufacture of weapons of mass destruction (WMD) or any other weapon is strictly prohibited.
2. The exports of SMC products or technology from one country to another are governed by the relevant security laws and regulation of the countries involved in the transaction. Prior to the shipment of a SMC product to another country, assure that all local rules governing that export are known and followed.

Caution

SMC products are not intended for use as instruments for legal metrology.

Products that SMC manufactures or sells are not measurement instruments that are qualified by pattern approval tests relating to the measurement laws of each country.
Therefore, SMC products cannot be used for business or certification ordained by the measurement laws of each country.

Operator

- ◆ This operation manual is intended for those who have knowledge of machinery using pneumatic equipment, and have sufficient knowledge of assembly, operation and maintenance of such equipment. Only those persons are allowed to perform assembly, operation and maintenance.
- ◆ Read and understand this operation manual carefully before assembling, operating or providing maintenance to the product.

■ Safety Instructions

Warning

- Do not disassemble, modify (including changing the printed circuit board) or repair.
An injury or failure can result.
- Do not operate the product outside of the specifications.
Fire, malfunction, or damage to the product can result.
Verify the specifications before use.
- Do not operate in an atmosphere containing flammable or explosive gases.
Fire or an explosion can result.
This product is not designed to be explosion proof.
- Do not use the product in a place where static electricity is a problem.
Otherwise it can cause failure or malfunction of the system.
- If using the product in an interlocking circuit:
 - Provide a double interlocking system, for example a mechanical system
 - Check the product regularly for proper operationOtherwise malfunction can result, causing an accident.
- The following instructions must be followed during maintenance:
 - Turn off the power supply
 - Stop the air supply, exhaust the residual pressure and verify that the air is released before performing maintenanceOtherwise an injury can result.
- Sensor to connect must be selected.
Actual potential can not be displayed unless selected value of the connect sensor is correctly set.
At initial setting or when sensor connected, ensure the selected value of the connected sensor and the type of used Electrostatic Sensor are matched.

■NOTE

- Follow the instructions given below when designing, selecting and handling the product.
- The instructions on design and selection (installation, wiring, environment, adjustment, operation, maintenance, etc.) described below must also be followed.
- *Product specifications
 - Operate the monitor with the specified voltage.
 - Operation with a voltage beyond specifications can cause malfunction or damage of the monitor.
 - Insufficient supply voltage may not drive a load due to a voltage drop inside the monitor.
 - Verify the operating voltage of the load before use.
 - Connect the sensor which outputs voltage within the specified range.
 - Otherwise it can cause damage to the monitor and an abnormal measurement.
 - Do not exceed the specified maximum allowable load.
 - Otherwise it can cause damage or shorten the lifetime of the monitor.
 - Reserve a space for maintenance.
 - Remember to leave space for maintenance when designing the piping plan.
 - The product is a UL approved product only if it has a  mark on the body.
- Product handling
 - *Installation
 - Do no drop, hit or apply shock to the monitor.
 - Otherwise it can result in damage to the monitor causing failure or malfunction.
 - Do not pull lead wires or lift the body with lead wires.
 - Hold the body when handling.
 - Otherwise it can result in damage of the monitor causing failure or malfunction.
 - Follow the specified tightening torque
 - Excessive tightening torque can break the monitor, bracket, and mounting screws. Insufficient tightening torque can displace the monitor from the original position or loosen the mounting screws.
 - Do not apply excessive external force with joints such as hoses when installing with a panel mount adapter.
 - Otherwise it can damage the panel of the monitor or cause drop off from the panel mount adapter.
 - Connect frame-ground terminal (FG terminal) to the ground when using a switching power supply.
 - Insert a noise filter (power line noise filter, ferrite core, etc.) between the switching power supply and this monitor when using analog output.
 - *Wiring
 - Do not bend or apply tensile stress to lead wires repeatedly.
 - Wiring with repetitive bending stress or tensile stress can cause breakage of the lead wires.
 - Replace the product when damage to a lead wire is observed.
 - The recommended bend radius of the lead wire is 6 times the outside diameter of the sheath, or 33 times the outside diameter of the insulation material, whichever is larger.
 - Connect wires and cables correctly.
 - Miswiring can break the monitor depending on a miswired circuit.
 - Do not connect wires while the power is on.
 - Otherwise it can break the circuit inside the monitor causing malfunction.
 - Do not lay wires or cables with power cable or high-voltage cable in the same wiring route.
 - Otherwise the wires to the Electrostatic sensor can be contaminated with noise or induced surge voltage from power lines or high voltage lines causing malfunction. Lay the wires to the monitor to a wire duct or in a protective tube other than those for power lines or high voltage lines.
 - Verify the insulation of wiring.
 - Poor insulation (interference with other circuit, poor insulation between terminals and etc.) can introduce excess voltage or current to the monitor causing damage.
 - Keep wiring as short as possible to prevent contamination from noise and induced surge voltage.
 - Do not use a cable longer than 10 m. Consult with SMC for the use with a cable longer than 10 m.
 - Connect the 0 V DC wire (blue line) directly or as close as possible to the 0 V DC terminal of the DC power supply.

- The direct-current power supply to combine should use UL authorization power supply which is the class 2 power supply based on UL 1310 or the power supply is using the transformer of a class 2 based on UL 1585.

***Environment**

- Do not use the product in an atmosphere containing corrosive gas, chemicals, seawater, water or vapor, or in a place where there is a possibility of adhesion of those substances to the product.
It can cause failure or malfunction.
- Avoid exposure of this product to direct sunlight.
Use sunshades if the product is exposed to direct sunlight.
Otherwise it can cause failure or malfunction.
- Do not use in a place where water, oil or chemicals splashes.
Otherwise it can cause failure or malfunction.
- Do not use a monitor nearby a place where electric surges are generated.
Internal circuit elements of the monitor can deteriorate or break when equipment generating a large surge (electromagnetic lifter, high frequency induction furnace, motor, etc.) is located near the monitor. Provide surge preventives, and avoid interference.
- Do not apply the monitor to the load that generates electric surge voltage.
Relays or solenoid valves generate electric surge voltage. When applying the monitor to drive these loads directly, use the product equipped with surge absorber.
- The product is not resistive to a lightning surge defined in CE marking. Take measures to protect against a lightning surge at the load side.
- Prevent foreign matter such as remnant of wires from entering this product.
Take proper measures for the remnant not to enter the monitor in order to prevent failure or malfunction.
- Do not expose the monitor to vibration and impact.
Otherwise it can cause damage or malfunction.
- Follow the specified ranges of the operating fluid and maintain ambient temperatures.
The ambient temperature should be in the range of 0 to 50 °C.
If the temperature is out of the specified range, resin parts may become fragile and be broken or deformed by heat, causing malfunction.
Take preventive measures against freezing. Do not use the monitor in a place where temperature suddenly changes even if it stays within the specified range.
- Do not expose the monitor to heat radiation from a heat source located nearby.
It can cause malfunction.

***Adjustment and Operation**

- Do not short-circuit the load.
The monitor indicates the error status when a load is short-circuited. However, excess current can damage the monitor.
- Do not press the buttons with a sharp object.
It can cause damage to the setting buttons.
- A warm-up time of 20 to 30 minutes is needed for detection of low potential.
The indication drifts about $\pm 1\%$ soon after the power is on.
- Do not touch the LCD during operation.
The indication on the LCD changes due to static electricity.

***Maintenance**

- Before performing maintenance, make sure to turn off the power supply.
Otherwise an unexpected operation of the system component can occur.
- Perform maintenance and check regularly.
Otherwise an unexpected malfunction of the system can occur due to a malfunction of the monitor.
- Perform a proper functional check after maintenance.
Stop operation when an abnormality is observed such that the device does not work properly.
Otherwise an unexpected malfunction of the system component can occur.
- Do not use solvents such as benzene or thinner to clean the monitor body.
It can damage the surface of the body and erase the indication on the body.
Use a soft cloth to remove stains. For heavy stains, use a cloth soaked with diluted neutral detergent and fully squeezed, then wipe up the stains again with a dry cloth.

Model Indication and How to Order

IZE11 -

Option 3

Symbol	Content
Nil	No option
C	Connector for sensor lead wire

Option 2

Symbol	Content
Nil	No option
A	Bracket
B	Panel mount adapter
C	Panel mount adapter + Front protective cover

Option 1

Symbol	Content
Nil	No option
L	Power and output lead wire

Output specification

Symbol	Content
0	NPN open collector 2 outputs + Analog output 1 to 5 V
1	NPN open collector 2 outputs + Analog output 4 to 20 mA
2	PNP open collector 2 outputs + Analog output 1 to 5 V
3	PNP open collector 2 outputs + Analog output 4 to 20 mA

Options/Part number

Description	Part number	Remarks
Power and output lead wire	ZS-28-A	Length 2 m
Bracket	ZS-28-B	With M3x5 L (2 pcs.)
Connector for sensor lead wire	ZS-28-C	1 pc.
Panel mount adapter	ZS-27-C	With M3x5 L (2 pcs.)
Panel mount adapter + Front protective cover	ZS-27-D	With M3x5 L (2 pcs.)
Front protective cover	ZS-27-01	

Summary of Product parts

Names of individual parts

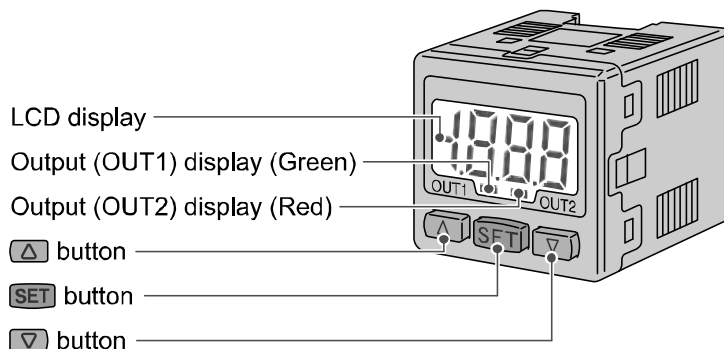

Output (OUT1) display (Green): Lit when OUT1 is ON.

Output (OUT2) display (Red): Lit when OUT2 is ON.

LCD display: Displays the current status of charged potential, set mode condition and error code. Four display modes can be selected display always in red or green only, or changing from green to red linked to output, or changing from red to green.

- Δ** button: Selects a mode and increases a set ON/OFF value.
Press this button to change to the peak display mode.
- ▽** button: Selects a mode and decreases a set ON/OFF value.
Press this button to change to the bottom display mode.
- SET** button: Changes the mode and sets a set value.

○Options

- Power and output lead wire (2 m): ZS-28-A
- Connector for sensor lead wire (1 pc.): ZS-28-C

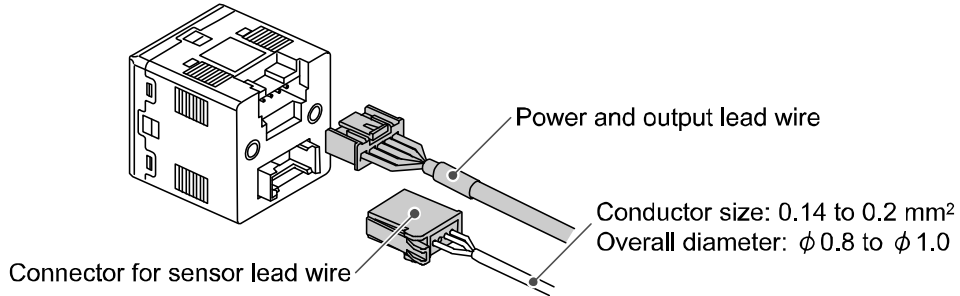

- Bracket with set screws M3x5 L (2 pcs.): ZS-28-B

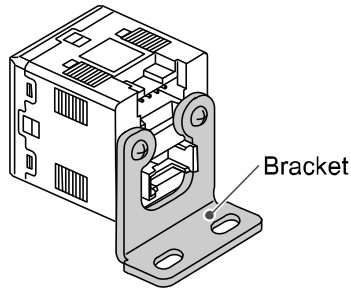

- Panel mount adapter with set screws M3x8L (2 pcs.): ZS-27-C
- Panel mount adapter with set screws M3x8L (2 pcs.) + Front protective cover: ZS-27-D
- Front protective cover: ZS-27-01

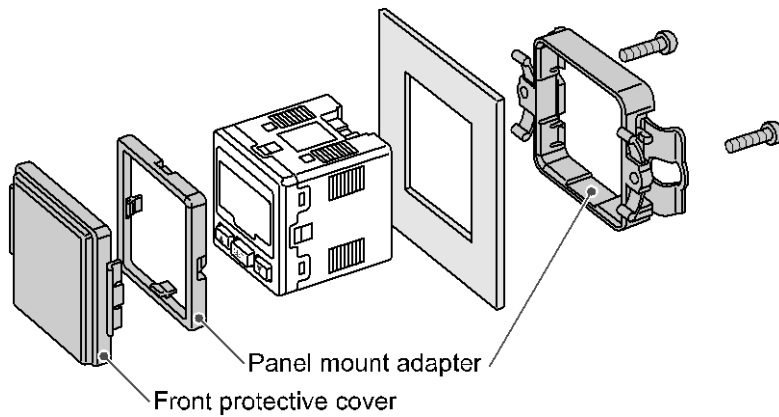

Mounting and Installation

■ Installation

○ Mounting

- Mount the optional bracket and panel mount adapter to the controller.

○ Mounting by bracket

- Fix the bracket to the controller with the set screws M3x5 L (2 pcs.) as attached.
- The tightening torque of the set screws must be 0.5 to 0.7 Nm.

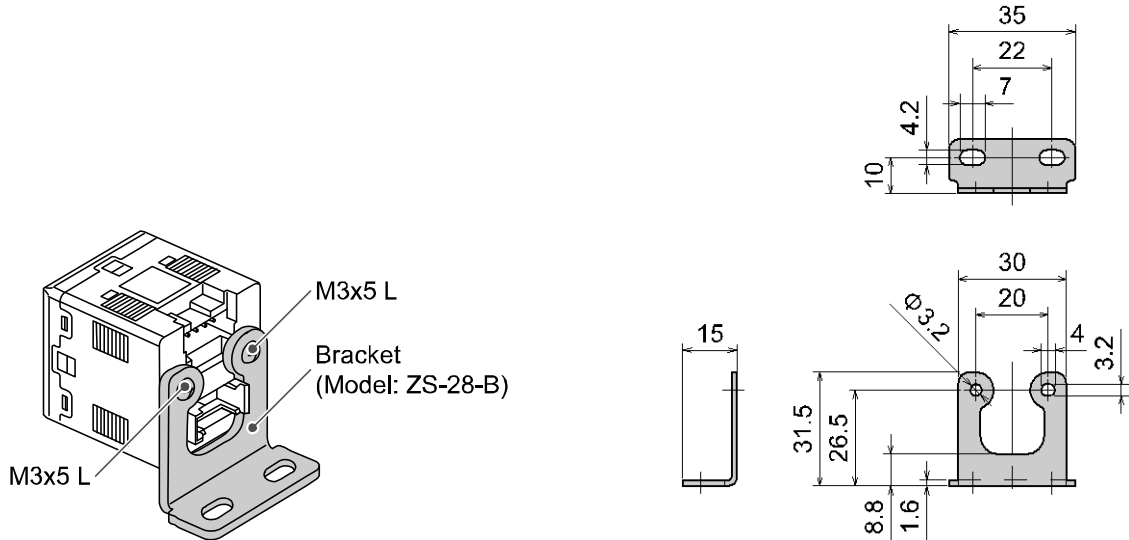

○ Mounting by panel mount adapter

- Fix the panel mount adapter to the controller with the set screws M3x8 L (2 pcs.) as attached.

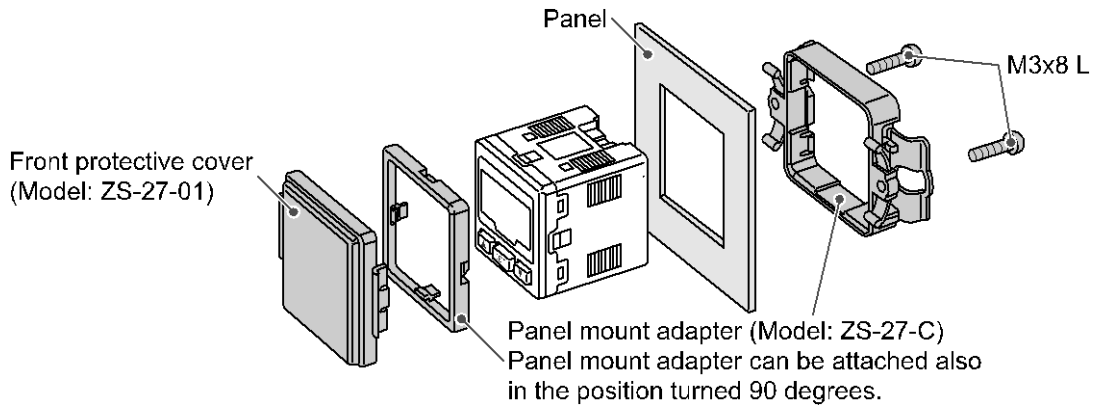

○ Notice when removing the controller

- The monitor with the panel mount adapter can be removed from facility by widening the hook of the monitor as following after removing two screws. The monitor and panel mount adapter may be damaged.

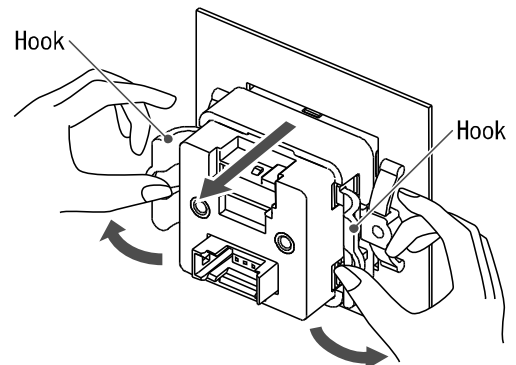

■Wiring

○Connection

- Connections should only be made with the power supply turned off.
- Use separate routes for the Electrostatic Sensor Monitor wiring and any power or high voltage wiring. Otherwise, malfunction may result due to noise.
- Ensure that the FG terminal is connected to ground when using a commercially available switch-mode power supply. When a switch-mode power supply is connected to the product, switching noise will be superimposed and the product specification can no longer be met. This can be prevented by inserting a noise filter, such as a line noise filter and ferrite core, between the switch-mode power supply and the product, or by using a series power supply instead of a switch-mode power supply.

○Attaching the connector to the lead wire

- Sensor wire is stripped as shown in the right figure.
(Do not strip the cable wire sheath)

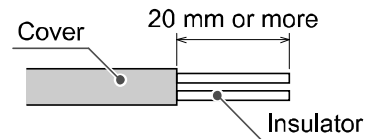

The correspondence table of each maker and SMC product number

SMC product No.	Sumitomo 3M Ltd. product No.	Tyco Electronics AMP K.K. product No.
ZS-28-C	37104-3101-000FL	1-1473562-4

- The core of the corresponding color shown in the following table is put into the pin of the number stamped on the connector for sensor connection to the back.

Number stamped on connector	Color of cable core
1	Brown (DC+)
2	N.C.
3	Blue (DC-)
4	White (IN: 1 to 5 V)

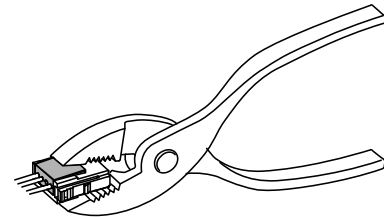
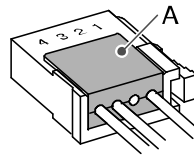

- It checks that the above-mentioned preparation work has been performed correctly, and A part shown in right figure is pushed by hand and makes temporary connection.
- A part center is straightly pushed in by tools, such as pliers.
- Re-use cannot be performed once it connects the connector for sensor connection completely. When you fail in the connection mistake of a core and a pin, or the plug of wire, please use the new connector for sensor connection.
- When the cable for sensor is cut in short length, do not connect the shield line.
(Shield line is common with amplifier case. Frame ground shall be prepared with the amplifier case side.)

○Connector

Connecting/Disconnecting

- When connecting the connector, insert it straight onto the pin holding the lever and connector body between fingers and lock the connector by pushing the lever claw into the square groove in the housing until connector clicks.
- When disconnecting the connector, push down the lever by thumb to disengage the lever claw from the square groove. Then pull the connector straight out.

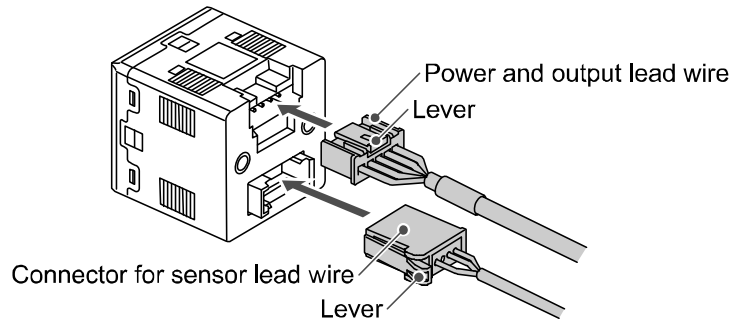

Pin No. of the connector for power and output lead wire

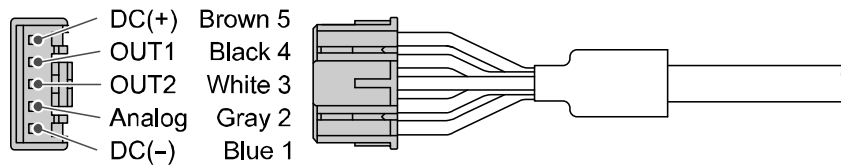

○ Internal circuit and wiring example

● Output specification

When the lead wire with SMC power and output lead wire (Model: ZS-28-A) is used, the colors of wire (Brown, Black, White, Gray, Blue) will apply as shown on circuit diagram.

IZE110

NPN open collector output: 2 outputs
 Max. 30 V, 80 mA
 Residual voltage 1 V or less
 Analog output: 1 to 5 V
 Output impedance: Approx. 1 k Ω

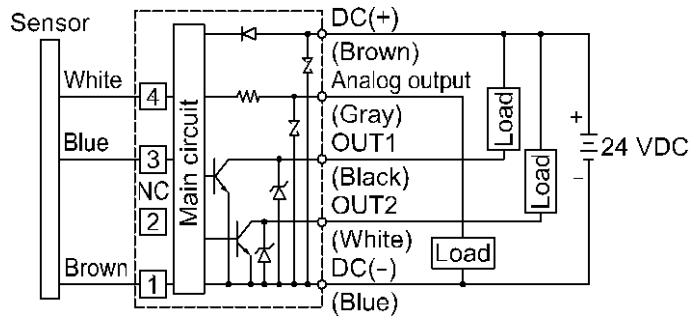

IZE111

NPN open collector output: 2 outputs
 Max. 30 V, 80 mA
 Residual voltage 1 V or less
 Analog output: 4 to 20 mA
 Max. load impedance: 600 Ω (at 24 VDC)
 Min. load impedance: 50 Ω

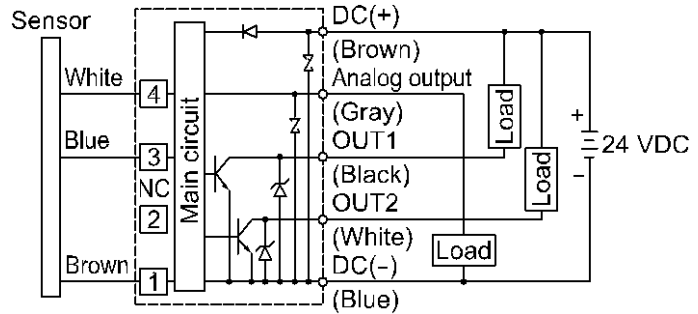

IZE112

PNP open collector output: 2 outputs
 Max. 80 mA
 Residual voltage 1 V or less
 Analog output: 1 to 5 V
 Output impedance: Approx. 1 k Ω

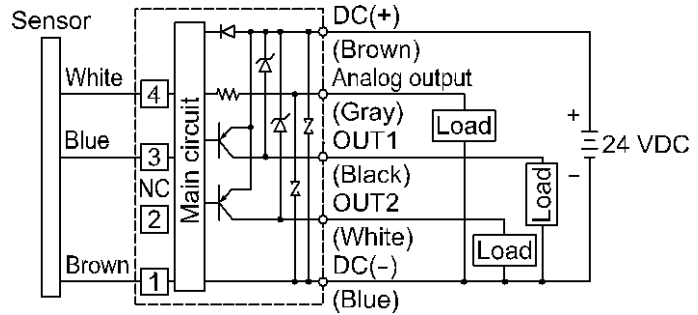

IZE113

PNP open collector output: 2 outputs
 Max. 80 mA
 Residual voltage 1 V or less
 Analog output: 4 to 20 mA
 Max. load impedance: 600 Ω (at 24 VDC)
 Min. load impedance: 50 Ω

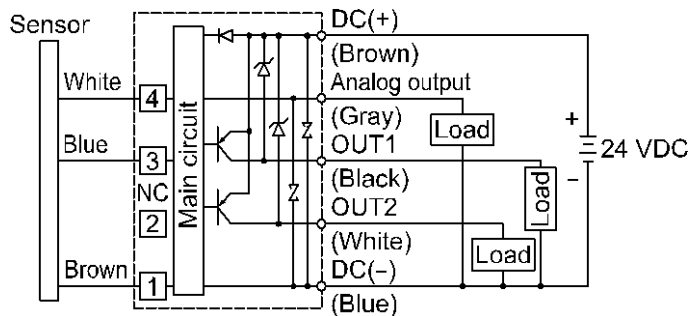

Setting

Setting procedures

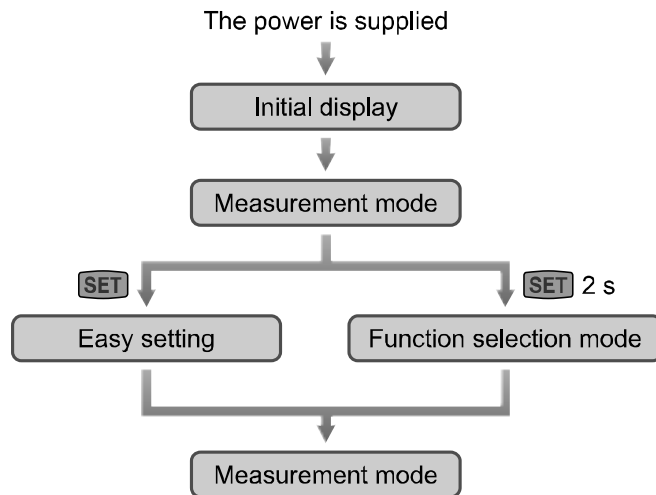

Initial display

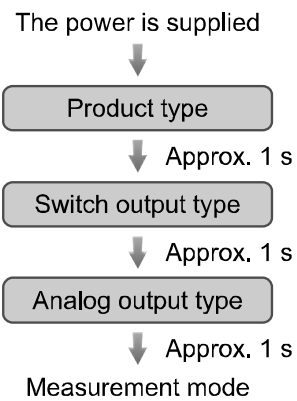

Item	Display	Content
Product type	Esd	IZE11□ series
Switch output type	nPn	NPN open collector output
	PnP	PNP open collector output
Analog output type	1_5	Voltage output (1 to 5 V)
	420	Current output (4 to 20 mA)

■ Measurement mode

Detect charged potential and perform display and switch operation.

Setting change and setting of other functions are available depending on purpose.

•List of output mode

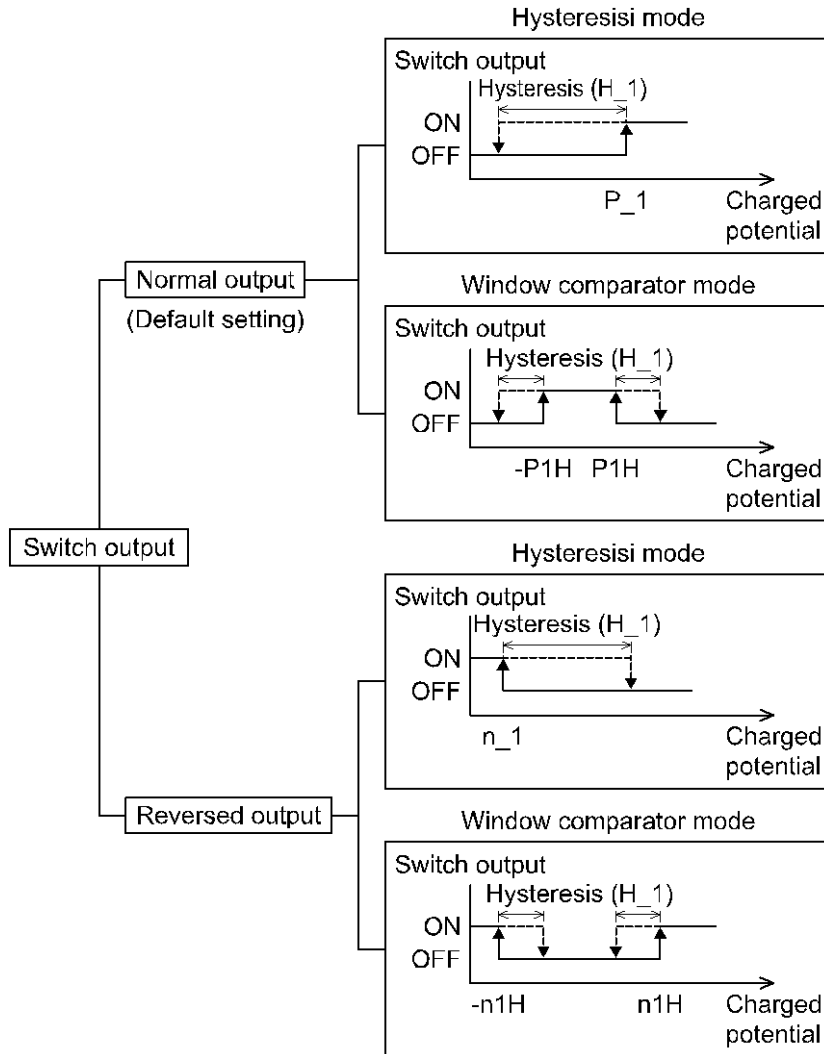

•The following is given using OUT1 as an example. The descriptions for OUT2 are the same as those for OUT1, under the conditions that [P_1] should be replaced by [P_2], [P1H] should be replaced by [P2H], [n_1] should be replaced by [n_2], [n1H] should be replaced by [n2H], [H_1] should be replaced by [H_2] and [H1] should be replaced by [H2].

•Absolute setting is assigned when window comparator is set. Therefore, set minus value is automatically reflected.

○Easy setting

Set ON and OFF point of switch output.

Switch turns ON when charged potential exceed set value.

Switch turns OFF when charged potential is lowered by more than hysteresis.

(This is an example when the switch output is normal output with hysteresis mode)

Electrostatic Sensor Monitor is set at ex-factory so that it turns ON with OUT1 at +0.2 kV and OUT2 at -0.2 kV.

If the operation shown below doesn't cause any problem, keep the operation.

Output mode can be changed with the operation of function selection mode [F 1] OUT1 and [F 2] OUT2.

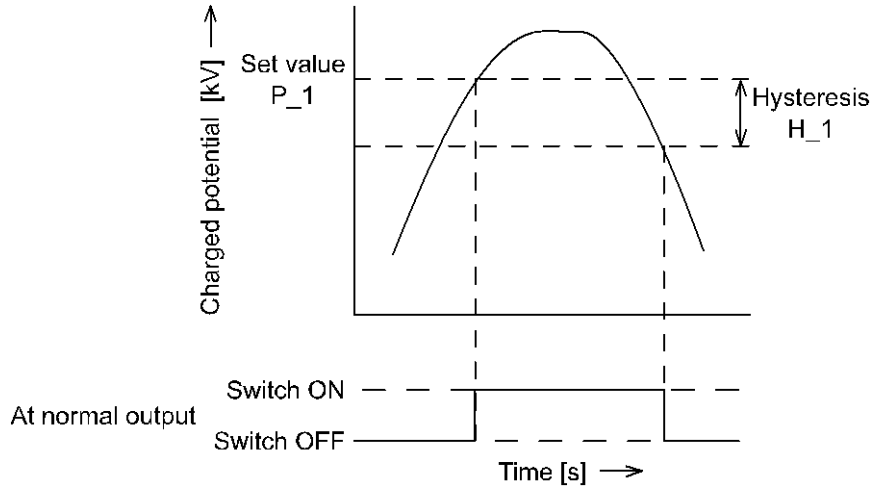



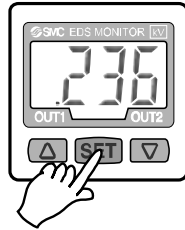

<How to operate> *: The switch will also output during setting.

1. Press the **SET** button once on the measurement mode.





2. [P_1] and set value are displayed in turn.



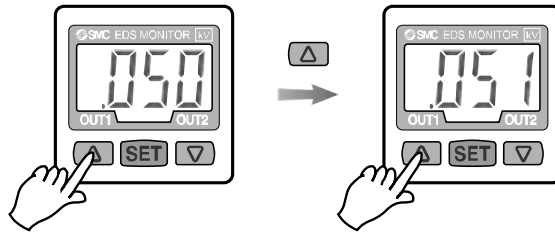

3. Press the  or  button to change the set value.
The  button is for increase and the  button is for decrease.

- Press the  button once to increase by one figure and press it continuously to keep set figure increased.

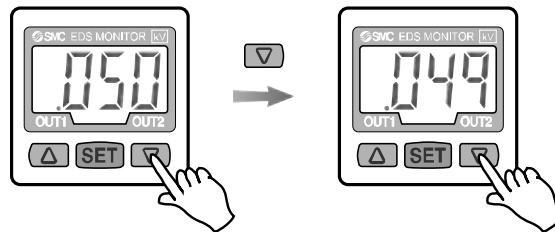

- Press the  button once to decrease by one figure and press it continuously to keep set figure decreased.



4. Press the  button to finish the setting.
Then [P_2] is displayed. Set as above.

■Function selection mode

In measurement mode, press the **SET** button for 2 seconds or longer to display [F 0].

Show the display of function setting to be changed, [F□□].

Press the **SET** button for 2 seconds or longer in function selection mode to return to measurement mode.

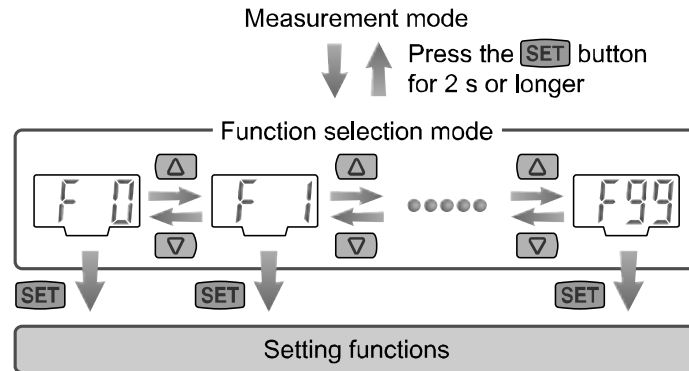

■Default setting

At the time of shipment, the following settings are provided.

If the setting is acceptable, keep it for use.

•NOTE

- When the default setting is changed, since the different setting item appears in order depending on how many times the **SET** button is pressed, confirm the item which needs to be set appears and prevent undesired setting.

Items below can be set at function selection mode.

Item	Default setting	Page
[F 0] Select connect sensor	Sensor for 0.4 kV	See page 19
[F 1] Operation of OUT1 [F 2] Operation of OUT2	Output mode	Hysteresis mode
	Reversed output	Normal output
	Charged potential setting	OUT1: +0.2 kV OUT2: -0.2 kV
	Hysteresis	Hysteresis: 0.04 kV
[F 1] Operation of OUT1	Display color	ON: Green OFF: Red
[F 3] Measured distance setting	25 mm	See page 22
[F 4] Setting of switch output response time	1 s	See page 23
[F 5] Select analog output filter	ON	See page 24
[F 6] Setting of security code	OFF	See page 25
[F98] Setting of all functions	OFF	See page 26
[F99] Reset to the default setting	OFF	See page 27

■[F 0] Select connect sensor

*: Select sensor to connect at initial setting or when the sensor is changed.

Range of connected Electrostatic Sensor can be selected.

<Operation>

Press the  or  button at function selection mode to display [F 0]

Press the  button. ↓ Moves on to select connect sensor.

Select connect sensor

Press the  or  button to select sensor range.

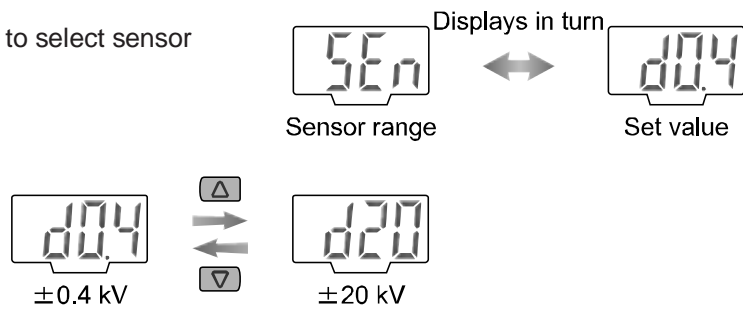

After selecting sensor range, press the  and  button together. ↓ Return to function selection mode.

Setting of [F_0] connected sensor completed

*: When connected Electrostatic Sensor range is changed, value corrected by switch output set value, peak value, bottom value and set distance zero adjust are returned to the state of shipment.



■[F 1] Operation of OUT1

Set output method of OUT1.

Output turns on when charged potential becomes larger the set value.

Display color depends on OUT1 output condition. When shipped out of factory, green lights when output is turned on. Red lights when output turned off.

<Operation>

Press the  or  button at function selection mode to display [F 1]

Press the  button.  Moves on to select output mode.

Select output mode

Press the  or  button to select output mode.

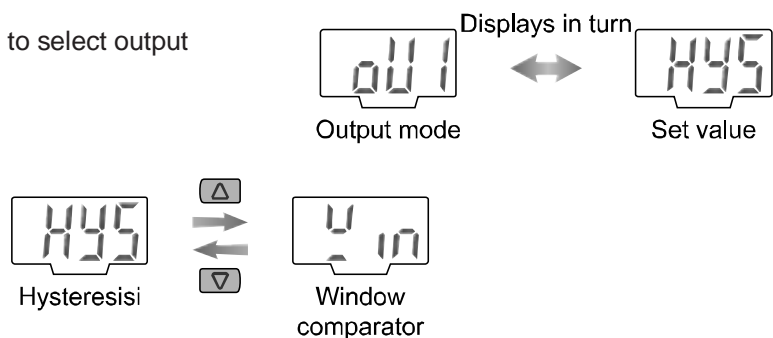

Press the  button to set.  Moves on to select reversed output

Select reversed output

Press the  or  button to select reversed output.

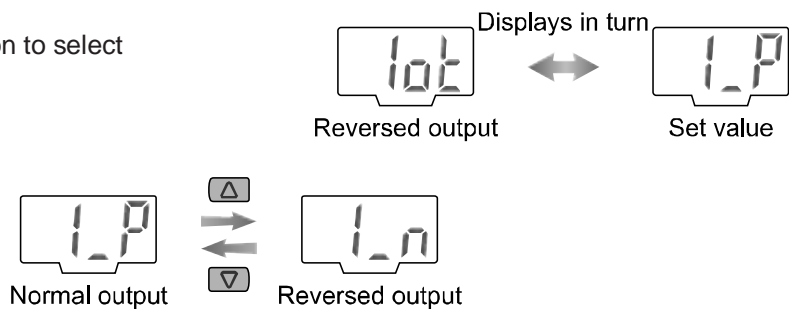

Press the  button to set.  Moves on to charged potential setting.

Charged potential setting

Set charged potential based on setting procedure on page 14.

Hysteresis mode: [P_1]

Window comparator mode: [P1H]

Press the  button to set.  Moves on to hysteresis change.

Hysteresis change

Press the Δ or ∇ button to select hysteresis.
 The Δ button increases hysteresis.
 The ∇ button decreases hysteresis..
 Chattering can be prevented by setting hysteresis.
 Hysteresis mode: [H_1]
 Window comparator mode: [H1]

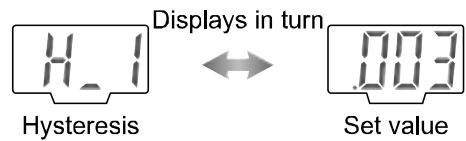

Press the **SET** button to set. \downarrow Moves on to display color setting.

Display color setting

Press the Δ or ∇ button to select display color.

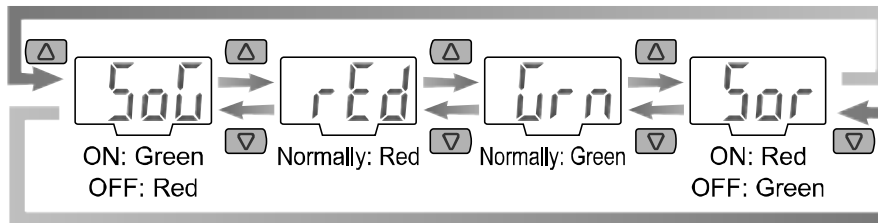
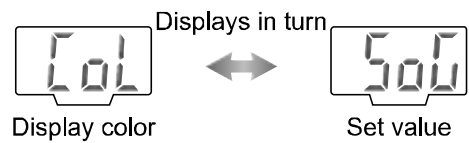

Press the **SET** button to set. \downarrow Return to function selection mode.

Setting of [F 1] operation of OUT1 completed

*: Set value or set hysteresis can be limited when window comparator mode is selected during reverse output mode.

Example 1) When hysteresis is set (Set value (n1H) is set to 0.1[kV])

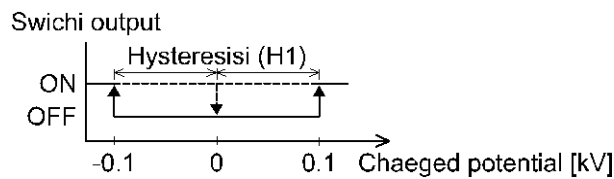

Hysteresis (H1) can not be set to mode than 0.1[kV].

Example 2) When set value is set (Hysteresis (H1) is not to 0.1[kV])

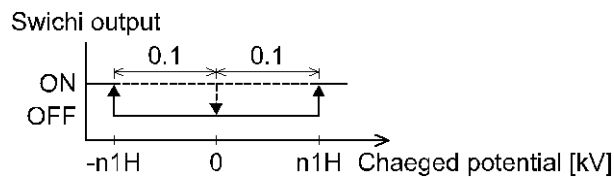

Set value (n1H) can not be set to less than 0.1[kV].

■[F 2] Operation of OUT2

Set output method of OUT2.

Display color depends on OUT1 output, and is not set with this function.

<Operation>

Press the  or  button at function selection mode to display [F 2]

Press the  button.  Moves on to select output mode.

Set based on [F 1] operation of OUT1 (page 20 to 21).

■[F 3] Measured distance setting

Input distance between charged object and the sensor.

Measurement distance or 0.4 kV sensor is settable within 10 to 50 mm, 20 kV sensor within 25 to 75 mm.

Distance can be changed by 1 mm.

*: Upper/lower limit of measurement range depends on measured distance.

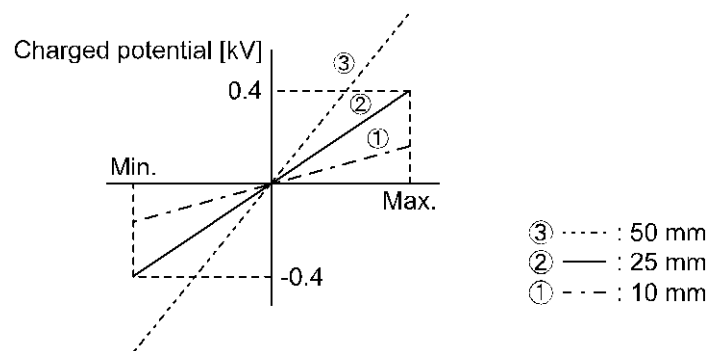

Peak values and bottom values wire reset when measures distance is changed.



Drawing above shows 0.4 kV sensor.

<Operation>

Press the  or  button at function selection mode to display [F 3]

Press the  button.  Moves on to measured distance setting.

Measured distance setting

Press the  or  button to measured distance setting.

The  button increases measured distance.

The  button decreases measured distance.

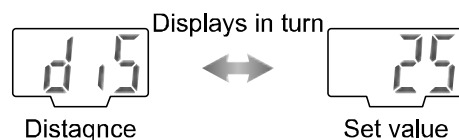

Press the  button to set.  Return to function selection mode.

Setting of [F 3] measured distance completed



■[F 4] Setting of switch output response time



Select switch output response time.

Output chattering is prevented by setting the switch output response time.

*: Slight displacement from set response time occurs due to the character of connected sensor.

<Operation>

Press the  or  button at function selection mode to display [F 4]

Press the  button.  Moves on to setting of switch output response time

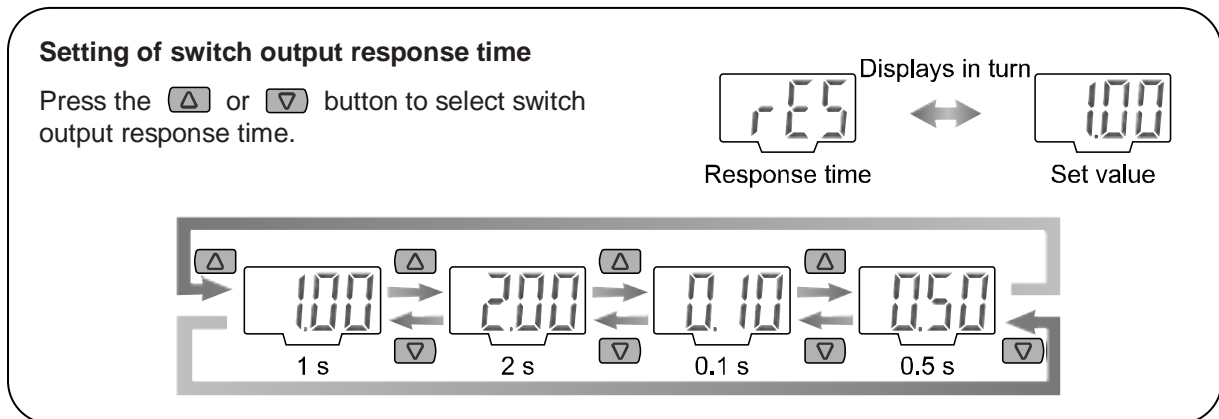

Press the  button to set.  Return to function selection mode.

Setting of [F 4] switch output response time completed

■[F 5] Select analog output filter

Faster response signal is available with turning off the filter of the analog output.

*: Slight displacement from set response time occurs due to the character of connected sensor.

<Operation>

Press the  or  button at function selection mode to display [F 5]

Press the  button.  Moves on to select analog output filter

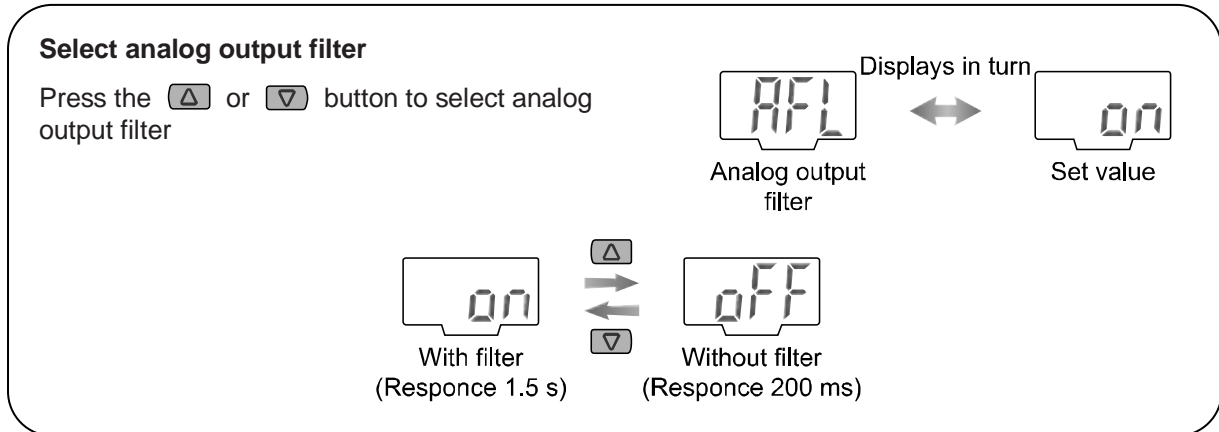



Press the  button to set.  Return to function selection mode.

Setting of [F 5] analogue output filter completed

■[F 6] Setting of security code

Security code can be entered during the key lock is released.
In the default setting, security code entry is not necessary.

<Operation>

Press the  or  button at function selection mode to display [F 6]

Press the  button.  Moves on to setting of security code.

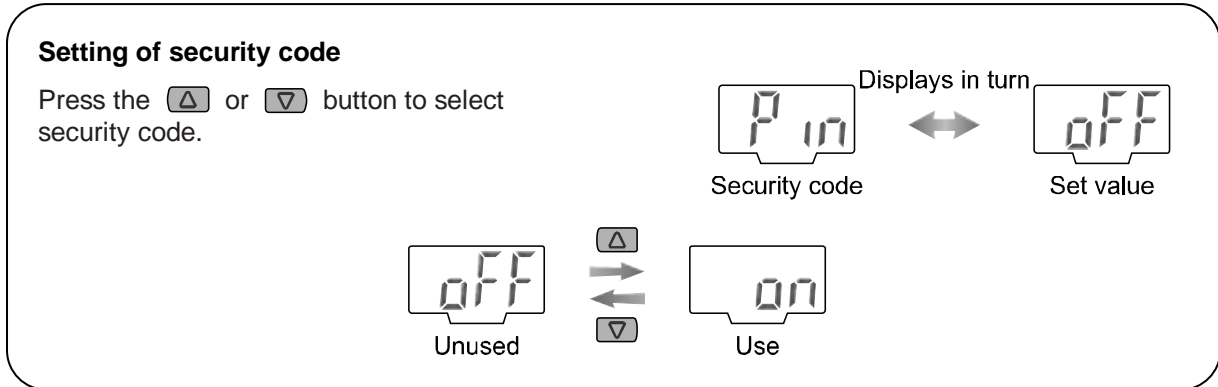

Press the  button to set.  Return to function selection mode.

Setting of [F 8] security code completed

If the security code is used, it is necessary to input the security code to release the key lock.
The security code can be set optionally by operator.
Default setting is "000".

Refer to page 30 when the security code is used.

■[F98] Setting of all functions

Function to display all setting items in turns.
 (Moves to the next setting without displaying F□□ display)

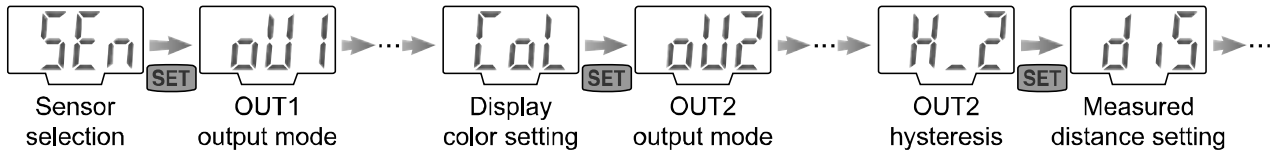

<Operation>

Press the or button at function selection mode to display [F98]

Press the button. ↓ Moves on to setting of all functions

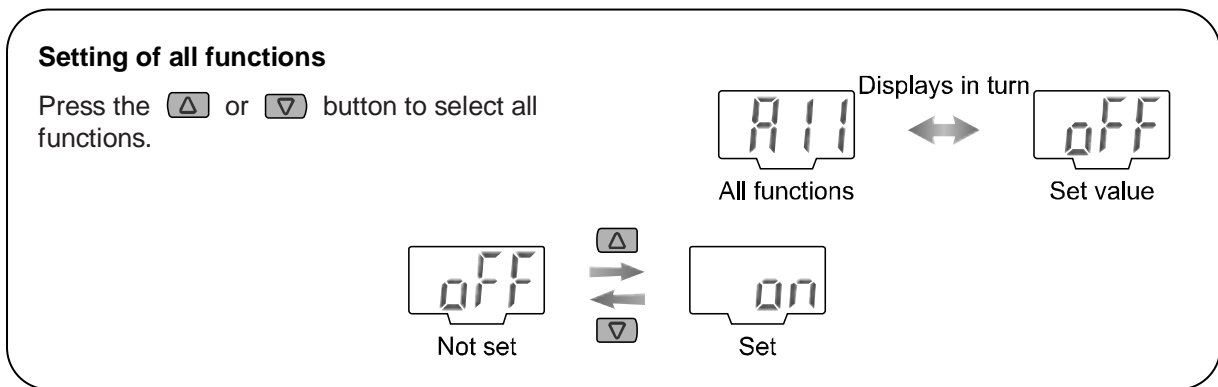

When [oFF] (Not to use) is selected

Press the button to set

Return to function selection mode

Return to [oFF](Not to use), the press the button to set

Return to function selection mode

When [on] (To use) is selected

Set functions

Press the button for 2 seconds or longer

Setting of [F98] all function can be set completed

Measurement mode

■[F99] Reset to the default setting

Function to return all set values to ex-factory condition.

<Operation>

Press the  or  button at function selection mode to display [F99]

Press the  button.  Moves on to reset to the default setting.

Reset to the default setting

Press the  or  button to select reset to the default setting.

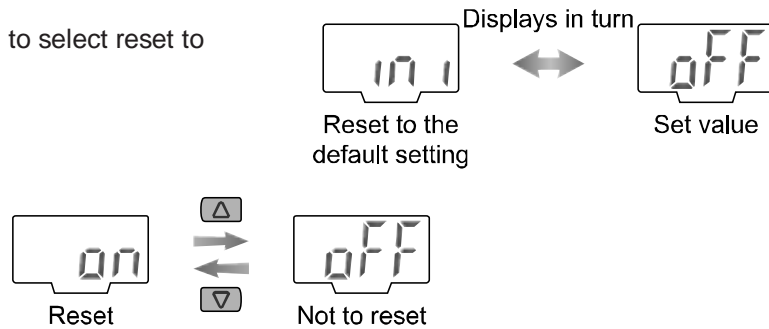

Press the  and  buttons simultaneously for 5 s. or more when "ON" is displayed.  Return to function selection mode.

Setting of [F99] reset to the default setting completed

Other settings

○Peak and Bottom hold value indication



The maximum (minimum) charged potential value from when the power is supplied to this moment is detected and updated. In peak/bottom indication mode, the charged potential is indicated.

As peak indication, maximum charged potential and Hi are displayed in turn by pressing the  button for 1 second or longer.

To release peak indication, press the  button for 1 second or longer.

As bottom indication, minimum charged potential and Lo are displayed in turn by pressing the  button for 1 second or longer.

To release bottom indication, press the  button for 1 second or longer.

Maximum (minimum) charged potential is initialized by pressing the  and  button simultaneously for 1 second or longer during hold display.

○Zero adjust function

Displayed value can be adjusted to zero when charged potential to be measured is within $\pm 10\%$ F.S. of default setting.

(Slight displacement occurs depends on individual difference and the sensor adjustment condition at zero adjustment)

Display value is reset to zero by pressing the  and  buttons for 1 second or longer simultaneously. Then operation mode automatically returns to measurement mode.

When this product is used for the first time, or the sensor is replaced, it is recommended to perform zero adjustment while connected sensor is not charged.

When this product is used for the first time, or the sensor is replaced, it is recommended to perform zero adjustment while connected sensor is not charged.

○Key lock

A wrong operation performed unintentionally such as change of set value can be prevented.

If the button operation is performed while key lock setting is being performed, "LoC" is displayed for approximate 1 second.

<Operation -Without security code input- >

- 1, Keep pressing the  button for 5 seconds or longer in measurement mode.

The current setting "LoC" or "UnL" is displayed.

(Releasing key lock can be done in the same way.)

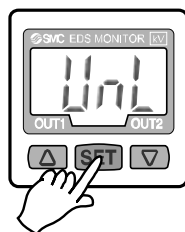

- 2, Press the  or  button to select locking or unlocking of the key.

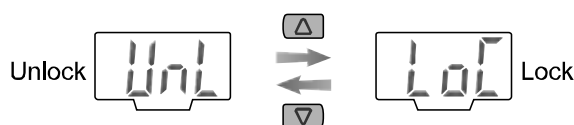

- 3, Press the  button to enter the setting.

<Operation -With security code input- >

•Locking

- 1, Keep pressing the **SET** button for 5 seconds or longer in the measurement mode. [UnL] is indicated.

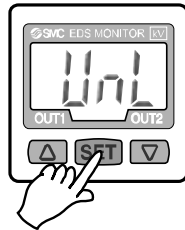

- 2, Press the **▲** or **▼** button to select locking of the key [LoC].

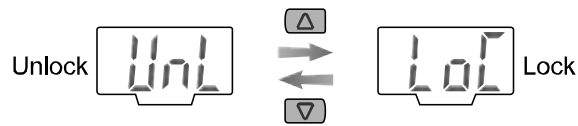

- 3, Press the **SET** button to enter the setting.

•Unlocking

- 1, Keep pressing the **SET** button for 5 seconds or longer in the measurement mode. [LoC] is indicated.

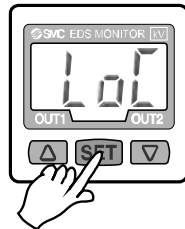

- 2, Press the **▲** or **▼** button to select unlocking of the key [UnL].

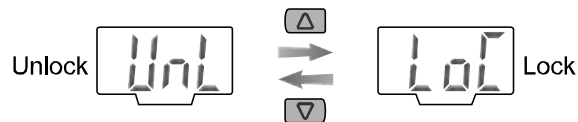

- 3, When the **SET** button is pressed, the input of security code is asked. For how to input the security code, refer to "How to input and change the security code" on page 30.

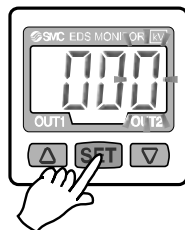

- 4, If inputted security code is correct, the indication changes to [UnL], and pressing one of **▲**, **SET** or **▼** button releases key lock and returns the measurement mode. If inputted security code is wrong, [FAL] is indicated and the security input mode is returned. If the wrong security code is inputted three times, [LoC] is indicated and the measurement mode is returned.

•How to change the security code

At the time of shipment, the security code is set to [000], but can be changed to optional one.

<Operation>

1, After the lock setting is finished (page 29), perform all three steps in the unlock setting procedure. (page 29, "3,").

2, After the security code is inputted and the indication changes to [UnL], keep pressing **SET** and **▽** buttons simultaneously for 5 seconds or longer.

[000] is indicated and the change of security code is asked.

For how to input the security code, refer to "How to input and change the security code".

Changed security code is indicated.

3, After check it is as desired, press the **SET** button for 1 second or longer.

The measurement mode is returned.

At this time, if the **△** or **▽** button is pressed, changed security code is not entered and the change of security code is asked.

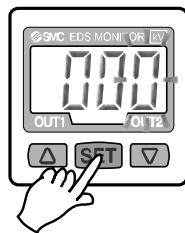

•How to input and change the security code

The 1 digit starts flashing.

Press the **△** or **▽** button to set the value.

Pressing **SET** button starts flashing the 2 digits.

(If **SET** button is pressed at the uppermost digit, the 1 digit starts flashing again.)

After the setting is finished, keep pressing **SET** button for 1 second or longer.

(If the operation is not performed for 30 seconds or longer during input and change of the security code, the measurement mode is returned.)

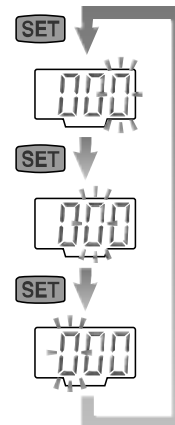

Error Indication Function

This function is to display error location and content when a problem or an error occurs.

Error Name		Error Display	Error Type	Troubleshooting Method
Over current Error	OUT1	Er1	A load current of switch output is 80mA or more.	Turn the power off and remove the output factor for the over current. Then turn the power on.
	OUT2	Er2		
System Error		Er3	Displayed in the case of an internal data error.	Turn the power off and turn it on again. If resetting fails, an investigation by SMC CORPORATION will be required.
Zero adjust Error		Er4	Potential exceeding than of default setting value by $\pm 10\%$ F.S is supplied to the sensor during zero adjustment. *: After approx. 1 s of display, mode automatic returns to measurement mode. Slight displacement occurs depends on individual difference and the sensor adjustment condition at zero adjustment.	Perform zero adjust operation after having the sensor not charged.
Over flow/ Under flow Error		HHH	Value is out of display range. Potential exceeding upper limit of measured voltage range is supplied to the sensor, or sensor installation position is not appropriate.	Eliminate the charge until the potential is reduced within measured voltage level. Check if measured distance and sensor mounting position is correct.
		LLL	Value is out of display range. Disconnection or incorrect wiring of the sensor is possible. Or, potential exceeding lower limit of measured voltage range is supplied to the sensor, or incorrect measured distance setting or sensor mounting position is possible.	

If the error can not be reset after the above measures are taken, then please contact SMC.

Specification

Specifications

Model No.		IZE11□	
Connected sensor	Sensor for ± 0.4 kV	Sensor for ± 20 kV	
Rated measured range	-0.4 to $+0.4$ kV *1	-20 to $+20$ kV *2	
Set min. unit	0.001 kV	0.1 kV	
Set measurement distance	10 to 50 mm	25 to 75 mm	
Power supply voltage	24 VDC $\pm 10\%$ (Protected against inverse connection)		
Current consumption	50 mA or less (Except current consumption at sensor)		
Sensor input	1 to 5 VDC (Input impedance: 1M Ω)		
Input number	1 input		
Input protection	Protection against excess voltage (up to 26.4V)		
Hysteresis	Hysteresis mode: Variable Window comparator mode: Variable		
Switch output	NPN or PNP open collector output 2 outputs		
Max. load current	80 mA		
Max. applied voltage	30 VDC (at NPN output)		
Residual voltage	1 V or less (at 80 mA load current)		
Response time (including sensor response time)	100 ms. or less, Chattering-proof function working, Response time is 500 ms, 1 s, 2 s or less		
Short circuit protection	Short protection equipped		
Analog output	Voltage output	Output voltage: 1 to 5 V (within rated measurement range) Output impedance: Approx. 1 k Ω	
	Accuracy (to display value 25 °C)	$\pm 1\%$ F.S.	
	Current output	Output current: 4 to 20 mA (Rated measurement range) Max. load impedance: 600 Ω (at 24 VDC) Min. load impedance: 50 Ω	
	Accuracy (to display value 25 °C)	$\pm 1\%$ F.S.	
	Response time (including sensor response time)	200 ms (No filter) 1.5 s (with filter) or less	
Indicator accuracy	$\pm 0.5\%$ F.S. ± 1 digit		
Display method	3 1/2 digits 7 segment display, two color (red/green) indication, sampling cycle: 5 times / 1 s		
Indicator lamp	OUT1: Turns on when ON (green), OUT2: Turns on when ON (red)		
Environment	Enclosure	IP40	
	Operating temp. range	Operation: 0 to 50 °C, Storage: -10 to 60 °C (No condensation or freezing)	
	Operating humidity range	Operation storage: 35 to 85%R.H. (No condensation)	
	Withstand voltage	1000 VAC, 1 min. Between live parts and enclosure at monitor alone	
	Insulation resistance	50 M Ω or more at 500 VDC, Between live parts and enclosure at monitor alone	
Temp. characteristic	$\pm 0.5\%$ F.S. (25 °C reference)		
Connection	Power and output lead wire: 5P connector, Connector for sensor lead wire: 4P connector		
Material	Front case: PBT, Back case: PBT		
Weight	30 g (Power and output lead wire not included)		
Standard	CE, UL/CSA		

*1: Rated value when the distance between charged object and the sensor is 25 mm.

*2: Rated value when the distance between charged object and the sensor is 50 mm.

Cable specifications: Power supply/Output connector (ZS-28-A)

Conductor	Nominal cross section area	0.2 mm ²
	Outside diameter	0.58 mm
Insulator	Material	Cross-linked vinyl chloride resin compound
	Outside diameter	Approx 1.12 mm
	Colors	Brown, Black, White, Grey, Blue
Sheath	Material	Oil-resistant vinyl chloride resin compound
Finished outside diameter		φ4.1

■Dimensions

○Body dimension

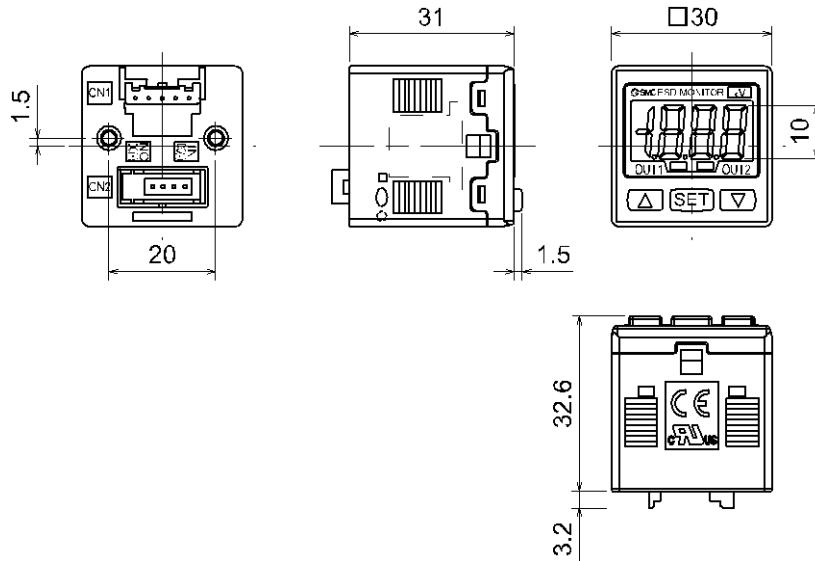

○Panel cutout dimension

●Single monitor

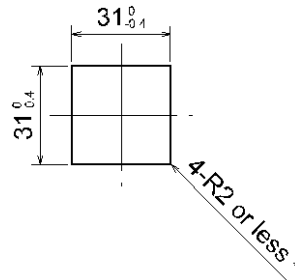

Panel thickness: 0.5 to 6 mm

*: When R is required, specify R2 or less.

●Two or more in a row

n: The number of the monitor

<Horizontal>

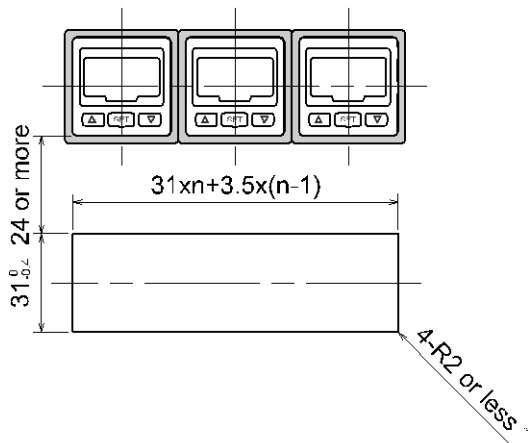

<Vertical>

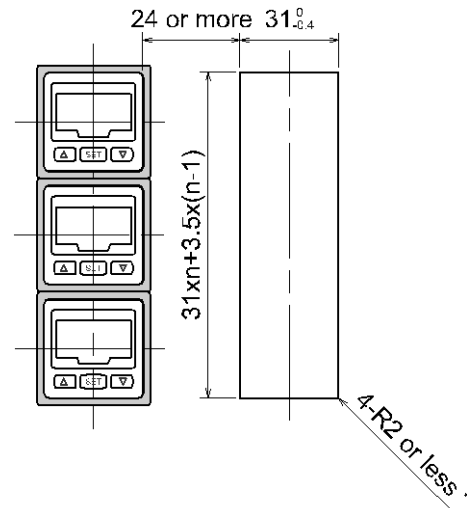

Revision history

A: Limited warranty and Disclaimer and measurement laws are added.

B: It changed in Note. (P5,P6)

SMC Corporation

4-14-1, Sotokanda, Chiyoda-ku, Tokyo 101-0021 JAPAN

Tel: +81 3 5207 8249 Fax: +81 3 5298 5362

URL <http://www.smcworld.com>

Note: Specifications are subject to change without prior notice and any obligation on the part of the manufacturer.
© 2010-2014 SMC Corporation All Rights Reserved

