



Operation Manual

PRODUCT NAME

Digital pressure switch for energy-saving
control ejector

MODEL / Series / Product Number

*ZME-ZSE***-A*

SMC Corporation

Table of Contents

A

Safety Instructions	2
Model indication and How to order	9
Summary of Product parts	10
Definition and terminology	11
Mounting and Installation	14
Installation	14
Wiring	15
Wiring	15
Internal circuit and wiring example	16
Easy Setting	17
Measurement mode	17
Function Setting	20
Function selection mode	20
Default setting	20
F0 Unit selection function	22
F1 OUT1	23
F2 OUT2	25
F3 Response time	27
F4 Auto-preset	28
F6 Fine adjustment of display value	30
F11 Display resolution	31
F80 Power saving mode	32
F81 Security code	33
F90 Setting of all functions	34
F96 Check of suction command signal	36
F98 Check of output	37
F99 Reset to the default setting	39
Other Settings	40
Maintenance	43
Troubleshooting	44
Error indication	50
Specification	51
Specifications	51



Safety Instructions

A

These safety instructions are intended to prevent hazardous situations and/or equipment damage. These instructions indicate the level of potential hazard with the labels of "Caution", "Warning" or "Danger". They are all important notes for safety and must be followed in addition to International Standards (ISO/IEC)*1), and other safety regulations.

*1) ISO 4414: Pneumatic fluid power -- General rules relating to systems.
ISO 4413: Hydraulic fluid power -- General rules relating to systems.
IEC 60204-1: Safety of machinery -- Electrical equipment of machines. (Part 1: General requirements)
ISO 10218: Manipulating industrial robots -Safety.
etc.



Caution

Caution indicates a hazard with a low level of risk which, if not avoided, could result in minor or moderate injury.



Warning

Warning indicates a hazard with a medium level of risk which, if not avoided, could result in death or serious injury.



Danger

Danger indicates a hazard with a high level of risk which, if not avoided, will result in death or serious injury.

Warning

1. The compatibility of the product is the responsibility of the person who designs the equipment or decides its specifications.

Since the product specified here is used under various operating conditions, its compatibility with specific equipment must be decided by the person who designs the equipment or decides its specifications based on necessary analysis and test results.

The expected performance and safety assurance of the equipment will be the responsibility of the person who has determined its compatibility with the product.

This person should also continuously review all specifications of the product referring to its latest catalog information, with a view to giving due consideration to any possibility of equipment failure when configuring the equipment.

2. Only personnel with appropriate training should operate machinery and equipment.

The product specified here may become unsafe if handled incorrectly.

The assembly, operation and maintenance of machines or equipment including our products must be performed by an operator who is appropriately trained and experienced.

3. Do not service or attempt to remove product and machinery/equipment until safety is confirmed.

1. The inspection and maintenance of machinery/equipment should only be performed after measures to prevent falling or runaway of the driven objects have been confirmed.

2. When the product is to be removed, confirm that the safety measures as mentioned above are implemented and the power from any appropriate source is cut, and read and understand the specific product precautions of all relevant products carefully.

3. Before machinery/equipment is restarted, take measures to prevent unexpected operation and malfunction.

4. Contact SMC beforehand and take special consideration of safety measures if the product is to be used in any of the following conditions.

1. Conditions and environments outside of the given specifications, or use outdoors or in a place exposed to direct sunlight.

2. Installation on equipment in conjunction with atomic energy, railways, air navigation, space, shipping, vehicles, military, medical treatment, combustion and recreation, or equipment in contact with food and beverages, emergency stop circuits, clutch and brake circuits in press applications, safety equipment or other applications unsuitable for the standard specifications described in the product catalog.

3. An application which could have negative effects on people, property, or animals requiring special safety analysis.

4. Use in an interlock circuit, which requires the provision of double interlock for possible failure by using a mechanical protective function, and periodical checks to confirm proper operation.



Safety Instructions

Caution

The product is provided for use in manufacturing industries.

The product herein described is basically provided for peaceful use in manufacturing industries. If considering using the product in other industries, consult SMC beforehand and exchange specifications or a contract if necessary. If anything is unclear, contact your nearest sales branch.

Limited warranty and Disclaimer/Compliance Requirements

The product used is subject to the following "Limited warranty and Disclaimer" and "Compliance Requirements".

Read and accept them before using the product.

Limited warranty and Disclaimer

1. The warranty period of the product is 1 year in service or 1.5 years after the product is delivered, whichever is first.*2)

Also, the product may have specified durability, running distance or replacement parts. Please consult your nearest sales branch.

2. For any failure or damage reported within the warranty period which is clearly our responsibility, a replacement product or necessary parts will be provided.

This limited warranty applies only to our product independently, and not to any other damage incurred due to the failure of the product.

3. Prior to using SMC products, please read and understand the warranty terms and disclaimers noted in the specified catalog for the particular products.

*2) Vacuum pads are excluded from this 1 year warranty.

A vacuum pad is a consumable part, so it is warranted for a year after it is delivered.

Also, even within the warranty period, the wear of a product due to the use of the vacuum pad or failure due to the deterioration of rubber material are not covered by the limited warranty.

Compliance Requirements

1. The use of SMC products with production equipment for the manufacture of weapons of mass destruction (WMD) or any other weapon is strictly prohibited.

2. The exports of SMC products or technology from one country to another are governed by the relevant security laws and regulation of the countries involved in the transaction. Prior to the shipment of a SMC product to another country, assure that all local rules governing that export are known and followed.

Operator

- ◆ This operation manual is intended for those who have knowledge of machinery using pneumatic equipment, and have sufficient knowledge of assembly, operation and maintenance of such equipment. Only those persons are allowed to perform assembly, operation and maintenance.
- ◆ Read and understand this operation manual carefully before assembling, operating or providing maintenance to the product.

■ Safety Instructions

Warning

- Do not disassemble, modify (including changing the printed circuit board) or repair.
An injury or failure can result.
- Do not use the product except for energy-saving control ejector
Fire, malfunction, or damage to the product or the system can result.
- Do not operate the product outside of the specifications.
Do not use for flammable or harmful fluids.
Fire, malfunction, or damage to the product can result.
Verify the specifications before use.
- Do not operate in an atmosphere containing flammable or explosive gases.
Fire or an explosion can result.
This product is not designed to be explosion proof.
- Do not use the product in a place where static electricity is a problem.
Otherwise it can cause failure or malfunction of the system.
- If using the product in an interlocking circuit.
 - Provide a double interlocking system, for example a mechanical system
 - Check the product regularly for proper operationOtherwise malfunction can result, causing an accident.
- The following instructions must be followed during maintenance.
 - Turn off the power supply
 - Stop the air supply, exhaust the residual pressure and verify that the air is released before performing maintenance.Otherwise an injury can result.
- Verify the system sufficiently before judging the applicability when a permeable workpiece is to be sucked.
Rapid decrease in vacuum pressure during suction of the workpiece may cause the ejector to fail to restart in time, causing injury or damage to the system because of the suction failure.

Caution

- Do not touch the terminals and connectors while the power is on.
Otherwise electric shock, malfunction or damage to the product can result.
- Perform sufficient trial run.
Otherwise, injury or damage to the system can result due to suction failure depending on the conditions of the suction of the workpiece or the pressure switch settings.
Perform sufficient verification before using this product.
- After maintenance is complete, perform appropriate functional inspections and leak test.
Stop operation if the equipment does not function properly or there is leakage of fluid.
If there is leakage from parts other than the piping, the product might be broken.
Cut off power supply and stop supplying fluid.
Do not supply fluid if there is leakage.
Safety cannot be assured in the case of unexpected malfunction.

■ NOTE

- Follow the instructions given below when designing, selecting and handling the product.
 - The instructions on design and selection (installation, wiring, environment, adjustment, operation, maintenance, etc.) described below must also be followed.
 - *Product specifications
 - Use the specified voltage.
Otherwise failure or malfunction can result.
 - Do not exceed the specified maximum allowable load.
Otherwise it can cause damage or shorten the lifetime of the Pressure switch.
 - Design the product to prevent reverse current when the circuit is opened or the product is forced to operate for operational check.
Reverse current can cause malfunction or damage to the product.
 - Input data to the Pressure switch is not deleted, even if the power supply is cut off.
(Writing time: 1,000,000 times)
 - For the details of compressed air quality, refer to ISO 8573-1, 1.1.2 to 1.6.2: 2001.
This can cause operating failure.
If compressed air containing condensate is used, install an air dryer or drain catch before the filter and perform drainage regularly.
If drainage is not performed regularly and condensate enters the secondary side, it can cause operating failure of pneumatic equipment.
If regular drainage is difficult, the use of a filter with an auto drain is recommended.
 - Applicable fluid is air, inert gases and incombustible gases.
Do not use a fluid containing chemicals, synthetic oils including organic solvent, salt and corrosive gases.
Otherwise, damage to the product and malfunction can result.
Check the details of the specifications before using.
 - Use the specified measurement flow rate and operating pressure.
Otherwise it can cause damage to the pressure switch or inability to measure correctly.
 - Reserve a space for maintenance.
Allow sufficient space for maintenance when designing the system.

● Product handling

* Installation

- Tighten to the specified tightening torque.

If the tightening torque is exceeded the mounting screws and brackets may be broken.

If the tightening torque is insufficient, the product can be displaced and loosen the mounting screws.

(Refer to page 14)

- Be sure to ground terminal FG when using a commercially available switch-mode power supply.

- Do not drop, hit or apply excessive shock (over 100 m/s²) to the Pressure switch.

Otherwise damage to the internal parts can result, causing malfunction.

- Do not pull the lead wire forcefully, not lift the product by pulling the lead wire. (Tensile force 20 N or less)

Hold the body when handling to avoid the damage of the Pressure switch which lead to cause the failure and malfunction.

- Eliminate any dust left in the piping by air blow before connecting the piping to the product.

Otherwise it can cause damage or malfunction.

- Do not insert metal wires or other foreign matter into the pressure measurement port.

It can damage the pressure sensor causing failure or malfunction.

- Never mount a Pressure switch in a location that will be used as a foothold.

The product may be damaged if excessive force is applied by stepping or climbing onto it.

- If the entering of foreign material to the fluid is possible, install and pipe the filter or the mist separator to the inlet to avoid failure and malfunction.

*Wiring

- Do not pull the lead wires.

In particular, never lift a Pressure switch equipped with fitting and piping by holding the lead wires. Otherwise damage to the internal parts can result, causing malfunction or to be off the connector.

- Avoid repeatedly bending or stretching the lead wire, or placing heavy load on them.

Repetitive bending stress or tensile stress can cause the sheath of the wire to peel off, or breakage of the wire. If the lead wire can move, fix it near the body of the product.

The recommended bend radius of the lead wire is 6 times the outside diameter of the sheath, or 33 times the outside diameter of the insulation material, whichever is larger.

Replace the damaged lead wire with a new one.

- Wire correctly.

Incorrect wiring can break the Pressure switch.

- Do not perform wiring while the power is on.

Otherwise damage to the internal parts can result, causing malfunction.

- Do not route wires and cables together with power or high voltage cables.

Otherwise the product can malfunction due to interference of noise and surge voltage from power and high voltage cables to the signal line. Route the wires (piping) of the product separately from power or high voltage cables.

- Confirm proper insulation of wiring.

Poor insulation (interference from another circuit, poor insulation between terminals, etc.) can lead to excess voltage or current being applied to the product, causing damage.

- Design the system to prevent reverse current when the product is forced to operate for operational check.

Depending on the circuit used, insulation may not be maintained when operation is forced, allowing reverse current to flow, which can cause malfunction and damage the product.

- Keep wiring as short as possible to prevent interference from electromagnetic noise and surge voltage.

Do not use a cable longer than 10 m.

Wire the DC(-) line(blue) as close as possible to the power supply.

*Environment

- Do not use the product in area that is exposed to corrosive gases, chemicals, sea water, water or steam. Otherwise failure or malfunction can result.

- Do not use in a place where the product could be splashed by oil or chemicals.

If the product is to be used in an environment containing oils or chemicals such as coolant or cleaning solvent, even for a short time, it may be adversely affected (damage, malfunction, or hardening of the lead wires).

- Do not use in an area where surges are generated.

If there is equipment which generates a large amount of surge (solenoid type lifter, high frequency induction furnace, motor, etc.) close to the Pressure switch, this may cause deterioration or breakage of the internal circuit of the Pressure switch. Avoid sources of surge generation and crossed lines.

- Do not use a load which generates surge voltage.

When a surge-generating load such as a relay or solenoid is driven directly, use a Pressure switch with a built-in surge absorbing element.

- The product is CE/UKCA marked, but not immune to lightning strikes. Take measures against lightning strikes in the system. B

This product is CE/UKCA marked, it may happen that the set value of product is changed by the noise impressed in excess.

- Mount the product in a place that is not exposed to vibration or impact.

Otherwise failure or malfunction can result.

- Prevent foreign matter such as remnant of wires from entering the Pressure switch.
Take proper measures for the remnant not to enter the Pressure switch in order to prevent failure or malfunction.
- Do not use the product in an environment that is exposed to temperature cycle.
Heat cycles other than ordinary changes in temperature can adversely affect the inside of the product.
- Do not expose the product to direct sunlight.
If using in a location directly exposed to sunlight, shade the product from the sunlight.
Otherwise failure or malfunction can result.
- Keep within the specified fluid and ambient temperatures range.
The fluid and ambient temperatures should be 5 to 50 °C. Operation under low temperature leads to cause damage or operation failure due to frozen moist in the fluid or air.
Protection against freezing is necessary. Air dryer is recommended for elimination of drain and water.
Avoid sudden temperature change even within specified temperature.
- Do not operate close to a heat source, or in a location exposed to radiant heat.
Otherwise malfunction can result.

*Adjustment and Operation

- Turn the power on after connecting a load.
Otherwise it can cause excess current causing instantaneous breakage of the Pressure switch.
- Do not short-circuit the load.
Although error is displayed when the Pressure switch load is short circuit, generated excess current lead to cause the damage of the Pressure switch.
- Do not press the setting buttons with a sharp pointed object.
It may damage the setting buttons.
- If using the product to detect very small pressure rates, warm up the product for 10 to 15 minutes first.
There will be a drift on the display of approximate 1% immediately after the power supply is turned on.
- Perform settings suitable for the operating conditions.
Incorrect setting can cause operation failure.
For details of each setting, refer to page 17 to 42 of this manual.
- The Pressure switch is compulsory turned off for 1 seconds after power supplied. A
For 4 seconds after supplying power, the measurement output is turned off.

*Maintenance

- Turn off the power supply, stop the supplied air, exhaust the residual pressure and verify the release of air before performing maintenance.
There is a risk of unexpected malfunction.
- Perform regular maintenance and inspections.
There is a risk of unexpected malfunction.
- Perform drainage regularly.
If condensate enters the secondary side, it can cause operating failure of pneumatic equipment.
- Do not use solvents such as benzene, thinner etc. to clean the Pressure switch.
They could damage the surface of the body and erase the markings on the body.
Use a soft cloth to remove stains. For heavy stains, use a cloth soaked with diluted neutral detergent and fully squeezed, then wipe up the stains again with a dry cloth.

Model Indication and How to order

How to order

ZME-ZSE □ □ □ -A

● Electrical entry of the solenoid valve and the pressure switch

G	Individual type (with 2 m lead wire with connector)
V	Integrated type (with 2 m lead wire with connector)
GO	Individual type (without connector and lead wire)
VO	Integrated type (without connector and lead wire)

● Unit specification

Nil	With unit conversion function
M	Fixed SI unit

● Pressure switch output type

A	NPN output
B	PNP output

Integrated cable assembly for the solenoid valve/pressure switch

ZM-LW □ -A

● Applicable switch output type

1	NPN output
2	PNP output

Summary of Product parts

A

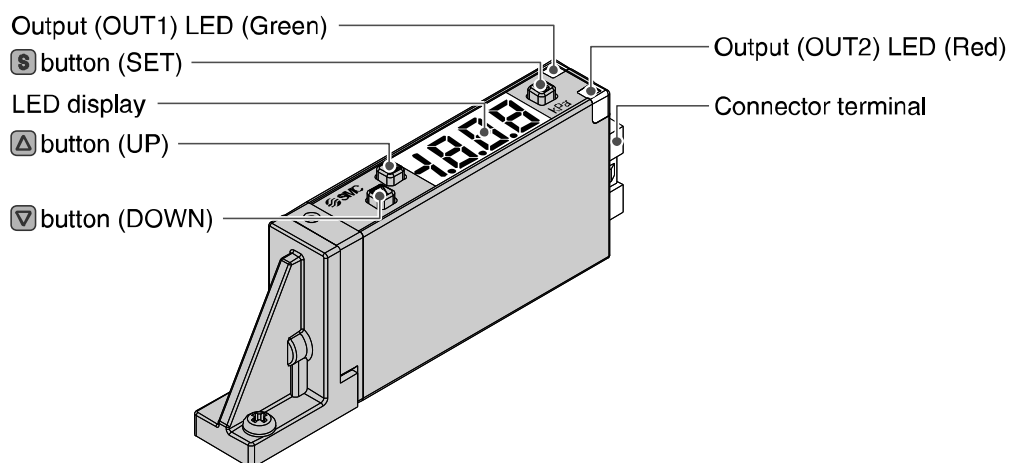

Output (OUT1) LED (green): LED is ON when the switch output (OUT1) is ON.

Output (OUT2) LED (Red): LED is ON when the supply pilot valve is ON.

LED display: Displays the current status of pressure, setting mode and error code.

▲ button (UP): Selects a mode and increases ON/OFF set value.

Press this button to change to the peak display mode.

▼ button (DOWN): Selects a mode and decreases ON/OFF set value.

Press this button to change to the bottom display mode.

■ button (SET): Press this button to change to another mode and to set a value.

■ Definition and terminology

No.	Terms	Meaning
7	7-segment indication	Display type where each individual display character consists of up to 7 separate sections (called segments) (The figure "8" uses all 7 segments)
A	Adsorption directive signal	Indicate the command signal which generate vacuum. (It is necessary to input the pressure switch)
	Auto preset	A function of the Pressure switch to automatically setup pressure just by having equipment hold and release a workpiece via vacuum adsorption. This function is used in an application where vacuum adsorption of a workpiece needs to be confirmed with a Pressure switch.
B	Bottom value display (mode)	Indicates the minimum vacuum pressure reached up to that moment.
C	Chattering	The problem of the switch output turning ON and OFF repeatedly around the set value at high frequency due to the effect of pulsation.
	Chattering-preventing function	A function to delay the response time of switch output in order to prevent chattering.
D	Digit (Min. setting unit)	Shows how precisely the pressure can be indicated or set by the digital Pressure switch. When 1 digit=1 kPa, the pressure is given with an increment of 1 kPa, e.g., 1, 2, 3, ..., 99, 100.
E	Energy saving automatic control	Indicate that the vacuum pressure during adsorption is monitored and ON and OFF of the ejector is automatically controlled.
	Error indication (Error code)	With the self-diagnosis function given to the Pressure switch, it indicates that there is a failure which could cause a switch failure.
F	Fine adjustment mode	Refer to "Fine adjustment of display value".
	Fine adjustment of display value	An indicated pressure value can be adjusted within the range of $\pm 5\%$ R.D. ($\pm 5\%$ of the indicated value). It is used if a true pressure value is known or to correct the difference of an indicated value of the measurement equipment nearby that measures the same pressure as the Pressure switch.
	F.S. (full span/full scale)	Abbreviation for full span and full scale; means the maximum fluctuation range of the Pressure switch rated value.
	Function selection mode	A mode in which setting of functions is performed. It is a separate menu from the pressure setting. If any function settings needs to be changed from the factory default, each setting can be selected with "F*". The setting items are: display color, operation mode, output type, response time, display resolution, display value fine adjustment, use of auto preset, use of power saving mode, and use of PIN number. Refer to page 23 for a list of output modes that can be selected.
H	Hysteresis	Difference between the points at which the Pressure switch is turned on and off.
	Hysteresis mode	Refer to "List of output modes" on page 23.

No.	Terms	Meaning
I	Indication accuracy	Shows the deviation between displayed pressure value and the true pressure.
	Insulation resistance	Insulation resistance of the product. The resistance between the electrical circuit and the case.
	Indication resolution	How fine the rated pressure range can be segmented. (Example: If a product for 0 to 1 MPa can indicate pressure by 0.001 MPa, the indication resolution is 1/1000.)
	Indication LED	The LED that turns on when the switch output is ON.
	Indication unit	The unit of pressure used in the display.
K	Key lock function	Function that prevents changes to the settings of the Pressure switch (disables button operation).
M	Manual set up	Manual pressure setup without using auto preset. This term is used to distinguish between manual and auto preset pressure setup.
	Max. applied voltage	The maximum value of applied voltage available to the output line of the NPN output.
	Max. (Min) load impedance	The maximum (minimum) load (resistance value and impedance) which can be connected to the output (output line) of the analog current output.
	Measurement mode	The condition in which the pressure is being detected and indicated and switch operation is enabled.
	Min. setting unit	Refer to "digit".
N	Normal output	One of the switch output types. In hysteresis mode the switch output is turned ON when pressure equal to or greater than the switch output set value is detected. Refer to "List of output modes" on page 23)
	NPN (open collector) (output)	The switch that uses the NPN transistor for output.
O	Output configuration	The operation principle of the switch output. Refer to "List of output modes" on page 23 for the operation status.
	Output mode	Either hysteresis mode can be selected.
P	Peak value display	Displays the maximum vacuum pressure reached up to that moment.
	Pilot valve for air supply	The solenoid valve which turns on and off the ejector. (This pressure switch outputs signal to the supply pilot valve)
	PNP (open collector) (output)	The switch that uses the PNP transistor for output.
	Power saving mode	The condition in which the indicated value turns off and current consumption is reduced.
	Pressure setting	The setting of pressure to determine the point at which the Pressure switch turns on and off.
	Proof pressure	Pressure limit that if exceeded will result in mechanical and/or electrical damage to the product.

No.	Terms	Meaning
R	Rated pressure range	The pressure range in which the Pressure switch satisfies the specifications. Values over this range can be set if they are within the set pressure range, but cannot assured the specifications to be satisfied.
	Repeatability	Reproducibility of the displayed value for pressure and ON-OFF output operating point when the pressure changes at a temperature of 25 °C.
	Residual voltage	The difference between the ideal ON voltage and the actual voltage when the switch output is on. It depends on present load current and ideally should be "0".
	Resolution	Refer to "Indication resolution".
	Response time	The time from when the pressure applied to the pressure switch reaches the set value, to when the ON-OFF output actually begins working. Generally, the shorter the response time, the better the performance.
	Reversed output (OUT1)	One of the switch output types. In hysteresis mode the switch output is turned ON when pressure less than or equal to the switch output set value is detected. (Refer to "List of output modes" on page 23)
S	Setting of function	Refer to "Function selection mode".
	Setting pressure range.	The pressure range within which switch output can be set.
	Switch output	Output type that only has 2 possible states, ON or OFF. Sometimes referred to as "ON-OFF output".
U	Unit selection function	Function to change the unit in which the value of pressure is indicated. Only a product with this function can change the unit. A product with unit-changing function cannot be purchased if it is used within Japan. Pressure is indicated only by SI units in Japan.
W	Withstand voltage	A measure of the product's resistance to a voltage applied between the electrical circuit and case. The product may be damaged if a voltage over this value is applied. (The withstand voltage is not the supply voltage used to power the product.)
Z	Zero clear (function)	Adjusts the displayed pressure value to "0".

Mounting and Installation

■ Installation

Mount the O-ring provided into the O-ring groove of the pressure switch, then put the pin into the pin insertion groove and mount the pressure switch to the ejector body with the two mounting screws supplied.

(The required tightening torque is 0.07 to 0.10 N•m)

If the tightening torque is exceeded, the mounting part can be deformed and broken.

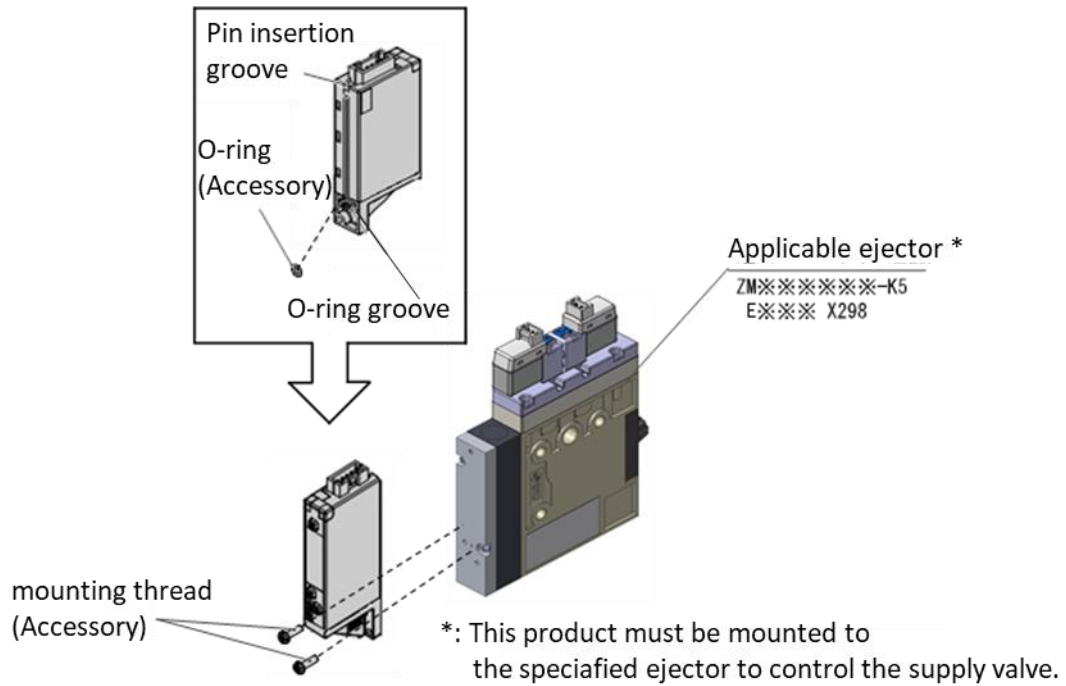

A

Wiring

■Wiring

○Connection

- Connections should only be made with the power supply turned off.
- Use separate routes for the Pressure switch wiring and any power or high voltage wiring. Otherwise, malfunction may result due to noise.
- Ensure that the FG terminal is connected to ground when using a commercially available switch-mode power supply. When a switch-mode power supply is connected to the product, switching noise will be superimposed and the product specification can no longer be met. This can be prevented by inserting a noise filter, such as a line noise filter and ferrite core, between the switch-mode power supply and the product, or by using a series power supply instead of a switch-mode power supply.

○Connector use for pressure switch

Connecting/Disconnecting

- When mounting the connector, insert it straight into the socket holding the lever and connector body, and push the connector until the lever hooks into the housing, and locks.
- When removing the connector, press down the lever to release the hook from housing and pull the connector straight out.

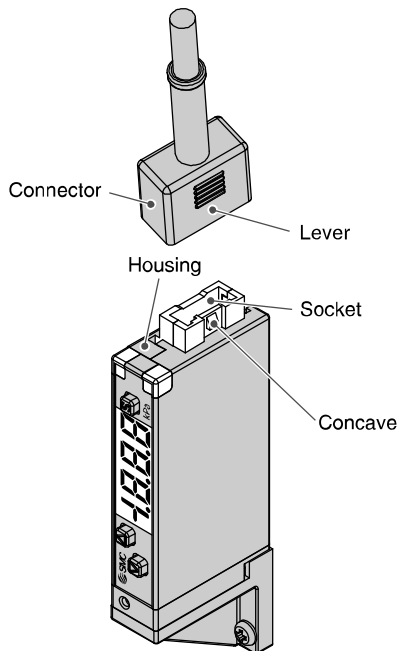

○Connection of integrated cable assembly for the solenoid valve/pressure switch

- Refer to the drawing below and connect the in integrated cable Ass'y to the applicable vacuum ejector.

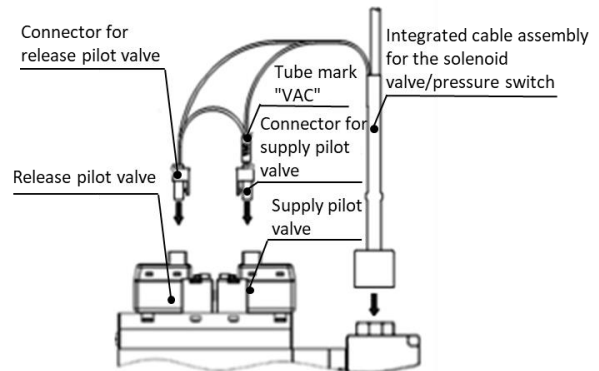

A

Power supply/output cable connector pin numbers (Pressure switch cable assembly)

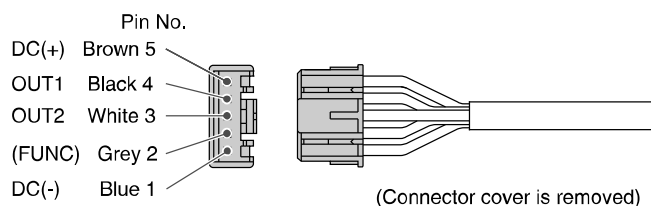

Internal circuit and wiring example

•NPN output type

NPN open collector 2 outputs (Use one output for controlling the supply pilot valve)

Max. applied voltage 26.4 V, Max. load current 80 mA

Residual voltage 2 V or less.

•Separate electrical entries for the pilot valves and the digital pressure switch

•Integrated electrical entry for the pilot valves and the digital pressure switch

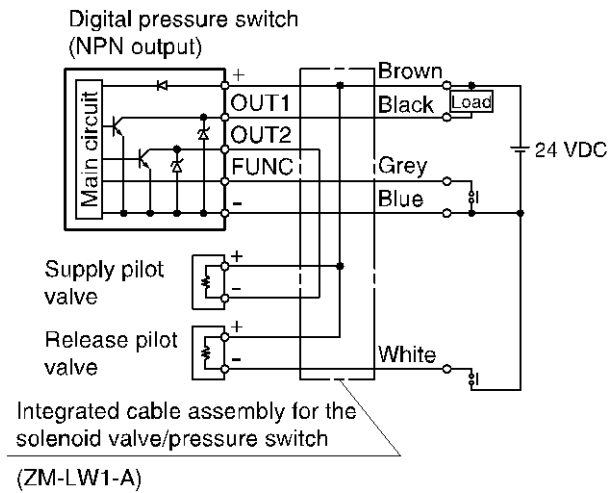
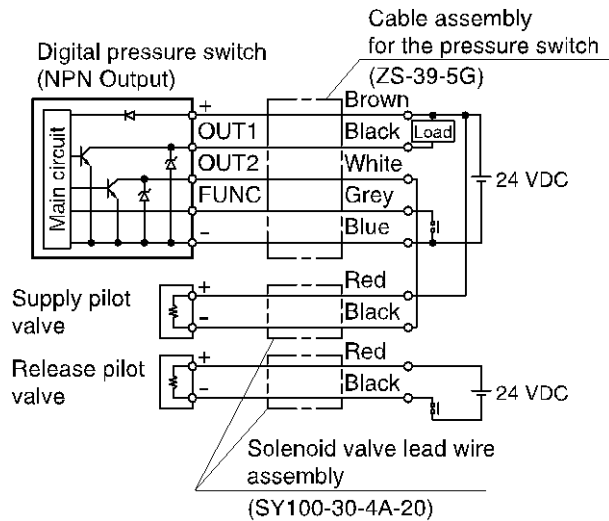

•PNP output type

PNP open collector 2 outputs (Use one output for controlling the supply pilot valve)

Max. load current 80 mA

Residual voltage 2 V or less.

•Separate electrical entries for the pilot valves and the digital pressure switch

•Integrated electrical entry for the pilot valves and the digital pressure switch

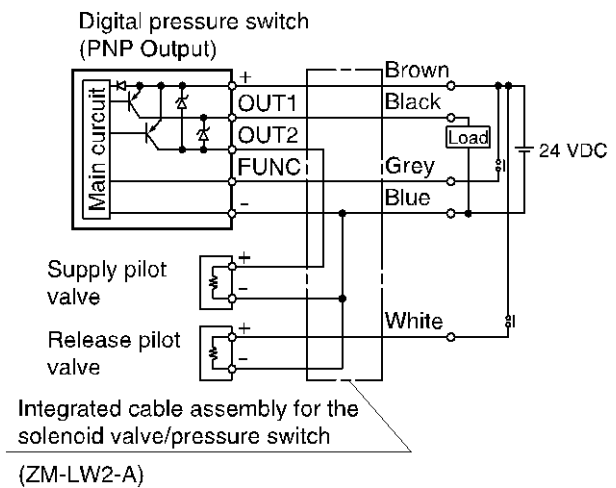
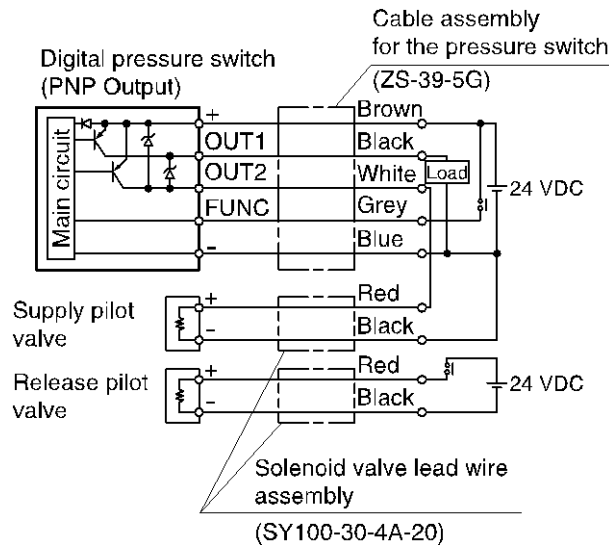

Easy Setting

■ Measurement mode

The measurement mode is the condition where the pressure is detected and indicated, and the switch function is operating.

This is the basic mode, and other modes should be selected for setting changes and other function settings.

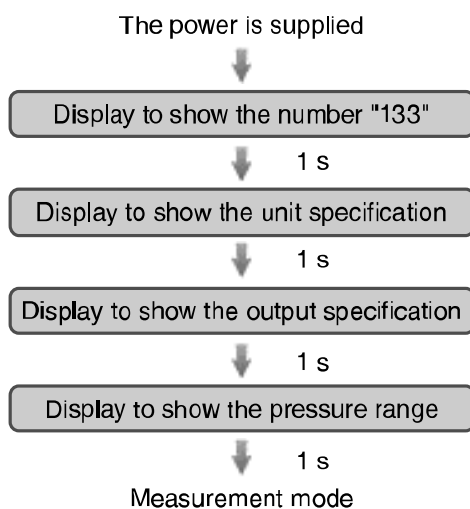

A

See below for the energy saving control operation and the set values which are preset to the switch.
 If the operation shown below is acceptable, then keep these settings.
 Function that enables the easy setting of the ON and OFF points of the switch output, and the operation of the supply pilot valve.

Operation of OUT1

When the pressure exceeds the set value (P_1), the pressure switch will be turned ON.
 When the pressure falls below the set value (P_1) by the amount of hysteresis value (H_1), the switch will be turned OFF.
 The default settings are P_1 : -70.0 kPa and H_1 :10.0 kPa.

Operation of OUT2

Supply pilot valve: OUT2 is turned on by the signal for suction. Suction starts by the generation of vacuum pressure.
 When the vacuum pressure reaches the set value (P_1), the supply pilot valve turns OFF.
 After the supply pilot valve is turned off, the vacuum pressure will decrease, when the vacuum pressure drops below (P_1) by the amount set in (P_2) the supply pilot valve will turn on again and increase the vacuum pressure.
 After that, supply pilot valve will turn ON and OFF repeatably.
 Default setting is H_2 : 5.0 kPa.

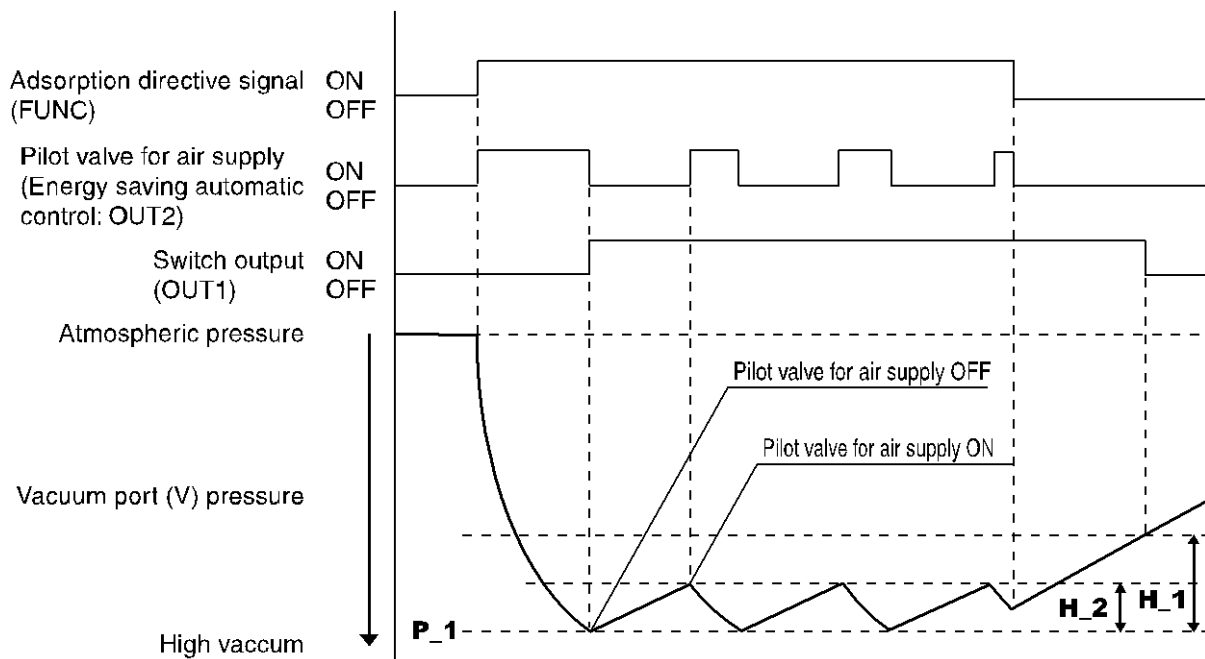

<How to change the set value>

[Normal output]

- (1) Press the **S** button once in measurement mode. (Refer to page 17)

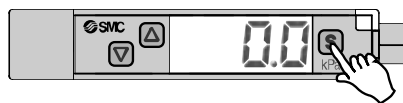

- (2) "P_1" and the set value are displayed in turn.

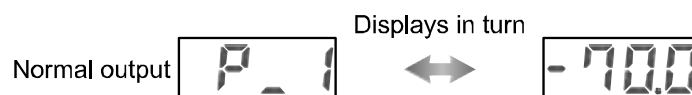

(3) Press the Δ or ∇ button to change the set value.

The Δ button is to increase vacuum pressure and the ∇ button is to decrease.

- Press the Δ button once to increase by one digit, and press it continuously to keep increasing the set value.

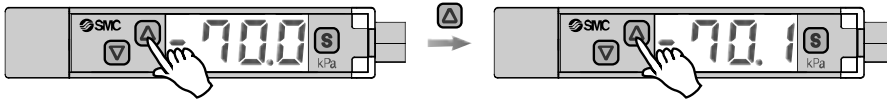

- Press the ∇ button once to decrease by one digit, press it continuously to keep decreasing the set value.

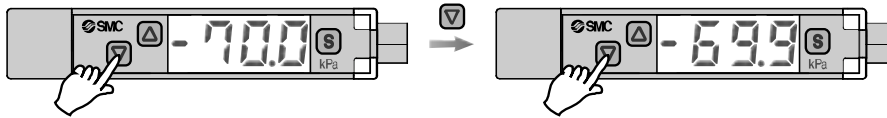

(4) Press the S button to complete the setting of "P_1". The display shows [H_1] and the set value in turn. The Δ button is to increase and the ∇ button is to decrease the set value.

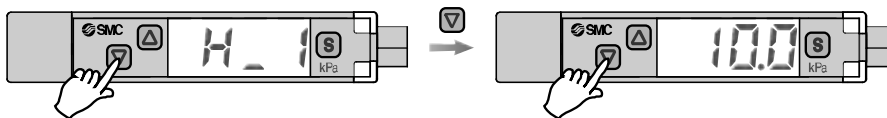

(5) Press the S button to complete the setting of "H_1". The display shows [H_2] and the set value in turn.

The Δ button is to increase and the ∇ button is to decrease the set value.

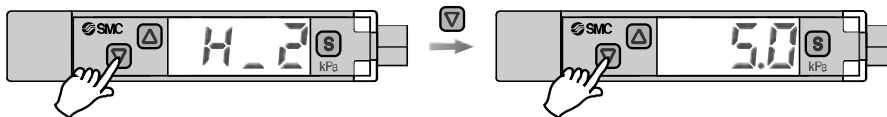

(6) Press the S button to complete the setting.

When the reversed output are changed, the following parameters are displayed, and each set value can be changed, using the method shown above.

For details of how to change the reversed output, refer to the setting of each function.

「Reversed output」

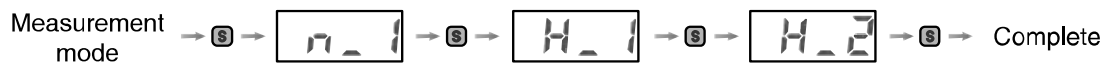

Function Setting

■ Function selection mode

In measurement mode, press the **[S]** button for 2 seconds or longer to display [F 0]. Select to display the function setting to be changed, [F □ □].

Press the **[S]** button for 2 seconds or longer in function selection mode to return to measurement mode.

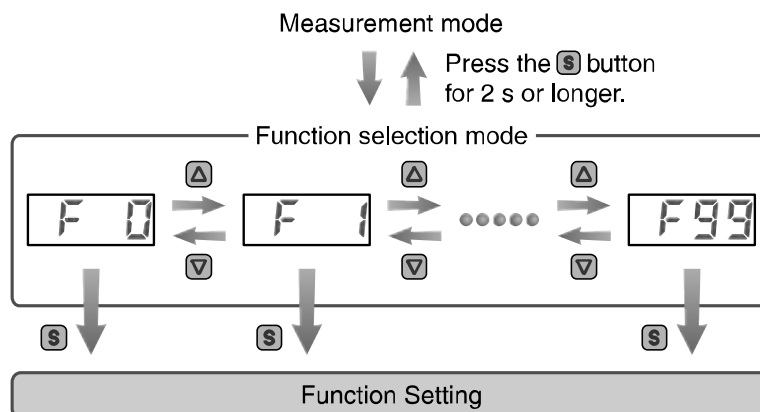

■ Default setting

The default settings are as follows

- [F 0] Unit selection function ➡ Refer to page 22

Item	Default setting
SI unit fixed Unit conversion function	kPa

- [F 1] Setting of OUT1 ➡ Refer to page 23

Item	Description	Default setting
Output mode	Select the hysteresis mode.	Hysteresis mode
Reversed output	Selects which type of switch output is used, normal or reversed.	Normal output
Pressure setting	Sets the ON or OFF point of the switch output.	-70 kPa(P_1)
Hysteresis	Set the hysteresis to prevent chattering.	10 kPa(H_1)

A

- [F 2] Setting of OUT2 ➡ Refer to page 25

Same setting as [F 1] OUT1.

Item	Description	Default setting
Supply pilot valve at signal ON	Sets the ON point of the supply pilot valve signal	5 kPa(H_2)
Supply pilot valve at signal OFF	Sets the OFF point of the supply pilot valve signal	0 kPa(H_3)
Set the range in which the supply pilot valve input is prohibited	Sets the range where the ON point of the supply pilot valve signal is not allowed to be input.	1 kPa(H_4)

A

Item	Page	Default setting
[F 3] Response time	See Page 27	2.5 ms
[F 4] Auto-preset	See Page 28	Manual
[F 6] Fine adjustment of display value	See Page 30	0%
[F11] Display resolution	See Page 31	1000-split
[F80] Power saving mode	See Page 32	OFF
[F81] Security code	See Page 33	OFF
[F90] Setting of all functions	See Page 34	OFF
[F96] Check of suction command condition	See Page 36	OFF
[F98] Check of output	See Page 37	Normal
[F99] Reset to the default setting	See Page 39	OFF

■ [F 0] Unit selection function

Setting is only possible when using a product with the unit selection function.
 (kPa/MPa can still be selected if the product does not have the unit selection function.)

<Operation>

Press the Δ or ∇ button in function selection mode to display [F 0].

Press the S button. \downarrow Move on to select the display unit.

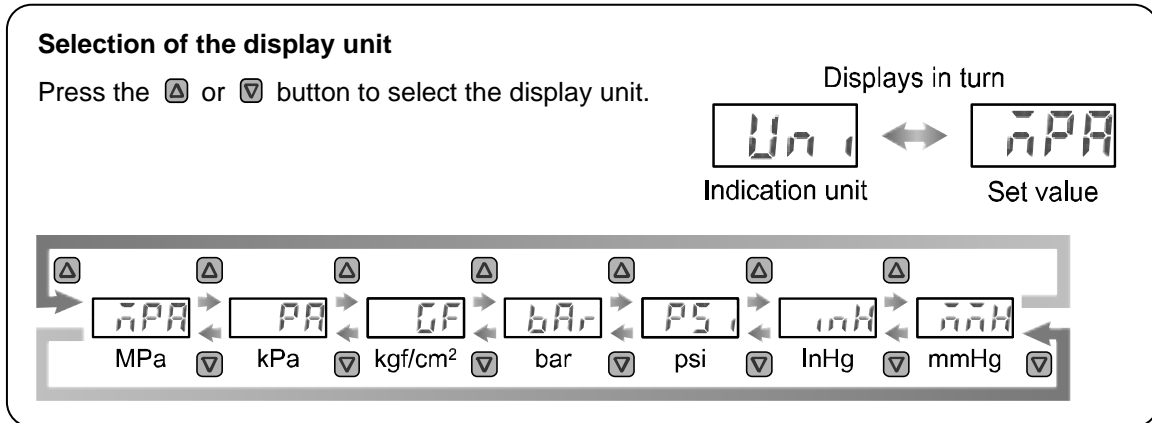

Press the S button to set. \downarrow Return to function selection mode.

Setting of [F 0] Unit selection function completed.

• Display unit and minimum setting unit.

Unit						
MPa	kPa	kgf/cm ²	bar	psi	InHg	mmHg
0.001	0.1	0.001	0.001	0.02	0.1	1

■[F 1] Setting of OUT1

The output mode of OUT1 can be set.

Reversed output, pressure value and hysteresis can be set.

- List of output modes

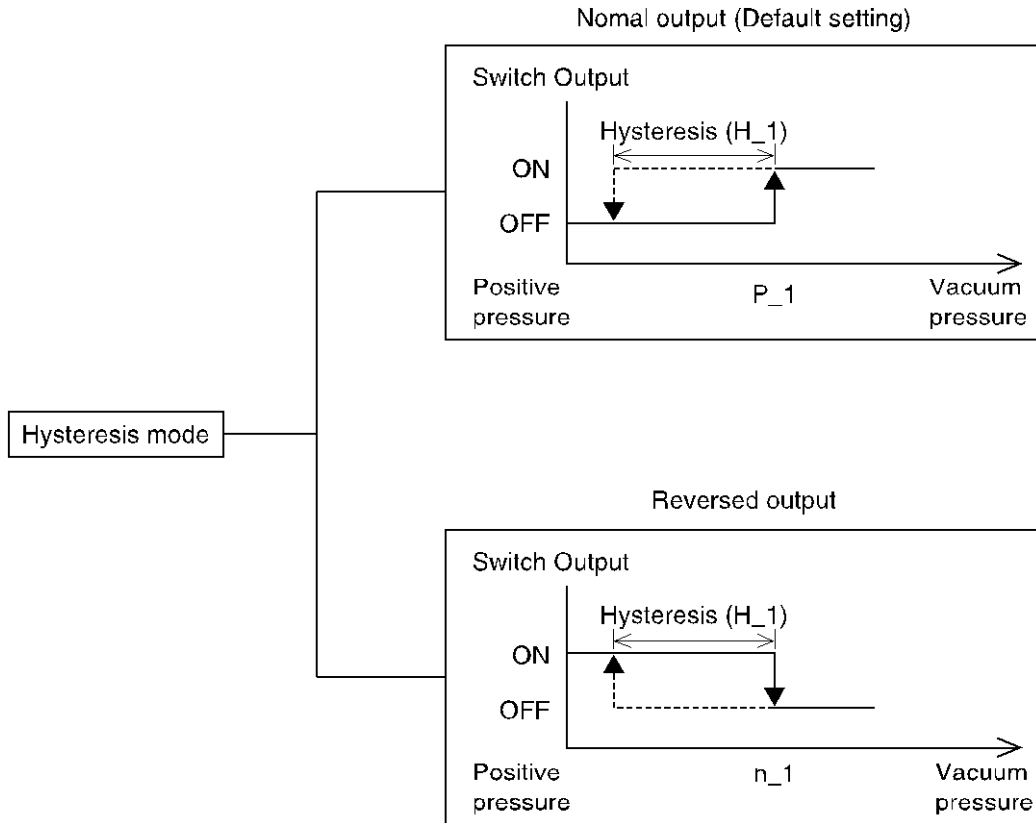

<Operation>

Press the or button in function selection mode to display [F 1].

Press the button. Move on to the check of output mode.

Check of output mode

Check the set value same as the display shown to the right, then move on to next setting.

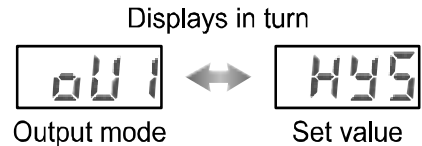

Press the button to set. Move on to setting of reversed output.

Setting of reversed output

Press the or button to select reversed output.

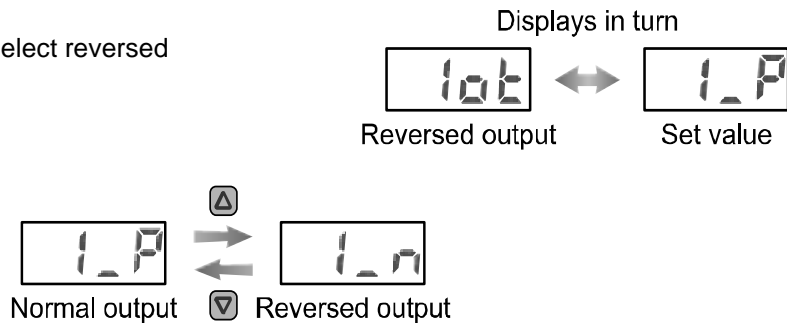

Press the button to set. Move on to setting of pressure.

Setting of pressure

Press the or button to adjust pressure setting.

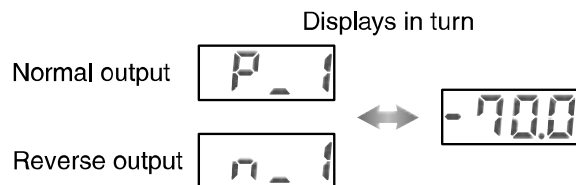

Press the button to set. Move on to setting of hysteresis.

Setting of hysteresis

Press the or button to select hysteresis.

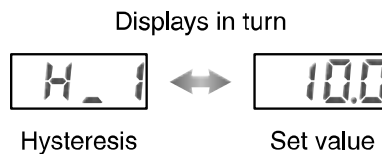

Press the button to set. Return to function selection mode.

[F 1] Setting of OUT1 complete.

■[F 2] Setting of OUT2

Set OUT2.

Set ON and OFF points of the supply pilot valve, and the range in which an input is not allowed.

A

Operation of OUT2

Supply pilot valve: OUT2 is turned on by the signal for suction. Suction starts by the generation of vacuum pressure.

When the vacuum pressure reaches the set value ($P_1 - H_3$: OFF point of supply pilot valve signal), the supply pilot valve is turned off.

After that, when the vacuum level decreases and reaches the suction switch ON point ($P_1 + H_2$: Supply pilot valve signal ON point), the supply pilot turns on again to maintain the vacuum.

After the supply pilot valve is turned off, the vacuum pressure will decrease.

When the vacuum pressure reaches the suction switch ON point ($P_1 + H_2$: ON point of supply pilot valve signal), the solenoid valve for supply will turn ON again and increase the vacuum pressure.

Afterwards, the supply pilot valve repeats this ON and OFF cycle.

Area in which setting of H_2 is prohibited can be set by the range in which H_4 : supply pilot valve signal is prohibited to input.

The default settings are P_1 : -70.0 kPa, H_1 :10.0 kPa, H_2 :5.0 kPa, H_3 :0.0 kPa, H_4 :1.0 kPa

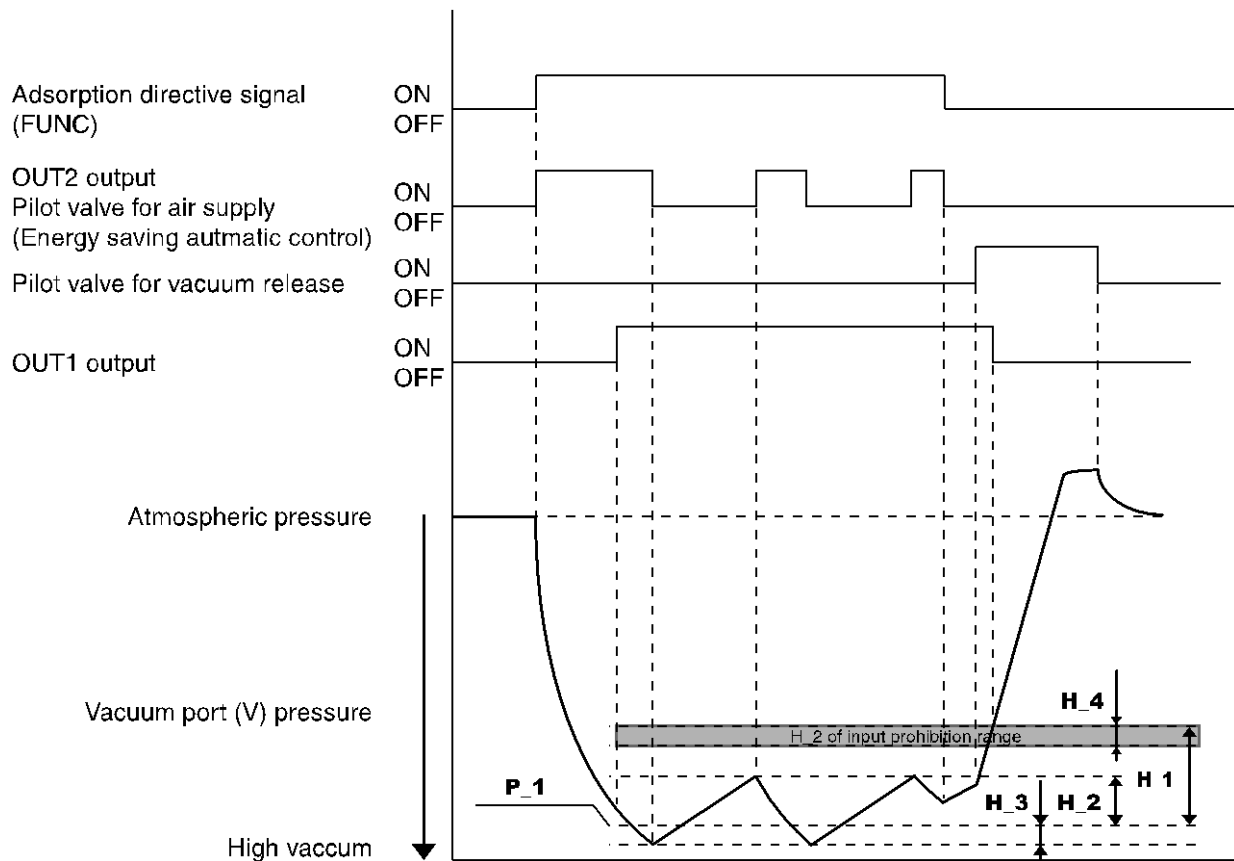

<Operation>

Press the or button in function selection mode to display [F 2].

A

Press the button to set. ↓ Move on to setting of pressure.

Press the or button to change the set points.

Setting ON point of the supply pilot valve

Displays in turn

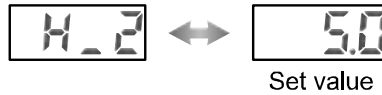

Press the button to set. ↓ Move on to the next parameter.

Setting OFF point of the supply pilot valve

Displays in turn



Press the button to set. ↓ Move on to the next parameter.

Set the range in which ON point of the supply pilot valve input is prohibited

Displays in turn



Press the button to set. ↓ Return to function selection mode.

[F 2] Setting of OUT2 complete.



- *1: Selected parameter become effective after pressing the button.
- *2: After setting is made valid by the button, it is possible to move to measurement mode by pressing the button for 2 seconds or longer.
- *3: OFF point (H_2) of the supply pilot valve is automatically corrected by setting the input prohibited range (H_4) of ON point of the supply pilot valve.



■[F 3] Response time

Select the response time of the switch output.



Output chattering can be prevented by setting the response time.

<Operation>



Press the  or  button in function selection mode to display [F 3].

Press the  button.  Move on to setting of response time.







Setting of response time

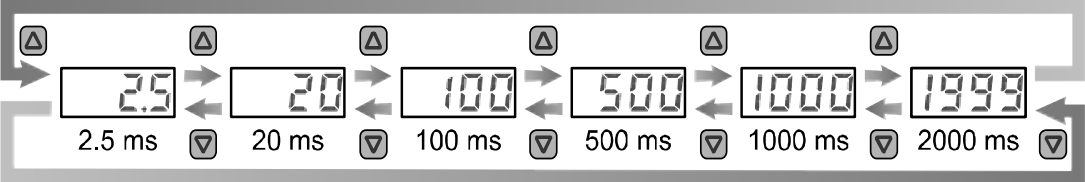

Press the  or  button to select the response time.

Displays in turn

 ↔ 
Response time Set value



2.5 ms  20 ms  100 ms  500 ms  1000 ms  2000 ms 



Press the  button.  Return to function selection mode.



Setting of [F 3] Response time completed.

■[F 4] Auto-preset function

This function calculates and sets the pressure values automatically based on the on-going operation.

<Operation>

Press the  or  button in function selection mode to display [F 4].

Press the  button.  Move on to setting of auto-preset function.

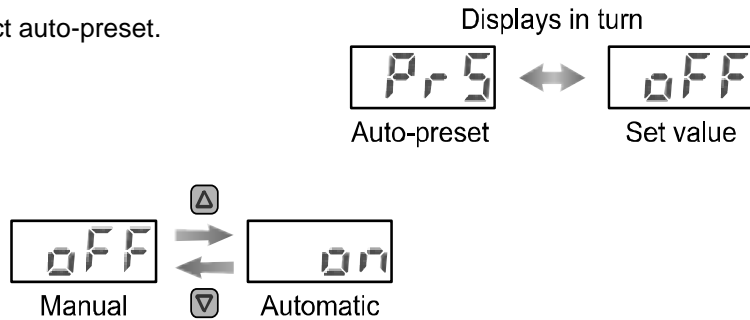

Setting of auto-preset

Press the  or  button to select auto-preset.



Press the  button to set.  Return to function selection mode.

Setting of [F 4] Auto-preset completed.

Press  button in measurement mode to set pressure. (Refer to page 29)
Then press  button again to change the pressure while the display is flashing.

*: ON/OFF point of the supply pilot valve and the set point of the input prohibited range of the supply pilot valve may be corrected by the auto-preset function.

•Auto-preset

When auto-preset is selected in function selection mode, the set value can be calculated and memorized from the measured pressure. Repeating the suction and release of a workpiece several times automatically optimizes the set value.

1, Selection of auto-preset OUT1

Press the **S** button in measurement mode to display "AP1".



2, Preparation of equipment for OUT1

Prepare equipment for which the pressure of OUT1 is to be set.

Auto-preset is ready

3, Setting of auto-preset for OUT1

Press the **S** button, the display will show "A1L" and pressure measurement begins .

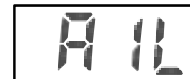

Operate the equipment and change the pressure.

When the a pressure change is detected, [A1H] will be displayed automatically, continue operating the equipment in the same manner for several cycles.

Auto-preset is being set

4, Completion of setting

Press the **S** button to set [P_1] and [H_1] (in reverse output mode [n_1] and [H_1] are set) and complete auto-preset mode. The pressure switch will then return to measurement mode. ([n_1] and [H_1] are set in reverse output mode.)

The settings made in auto-preset mode are as follows.

$$P_1 = A - (A - B) / 4$$

$$H_1 = |(A - B) / 2|$$

A = Maximum pressure value



B = Minimum pressure value

To clear the stored auto-preset settings, press the **▲** and **▼** buttons simultaneously for 1 second or longer.

■[F 6] Fine adjustment of display value

This function is used to manually perform fine adjustment of the displayed pressure. It is adjustable within the range $\pm 5\%$ R.D.



<Operation>

Press the  or  button in function selection mode to display [F 6].



Press the  button.  Move on to setting of fine adjustment of display value.

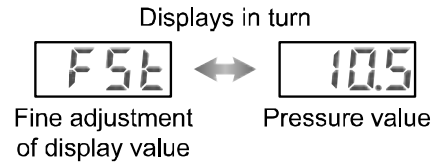

Setting of fine adjustment of display value

Current pressure value is displayed.

Press the  or  button to adjust the display value.



Press the  button to set. 

To initialize the adjustment value, when [FSC] is displayed, press the  and  buttons simultaneously for more than 1 second.

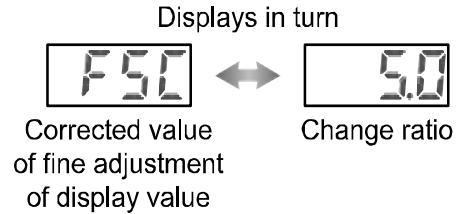



Press the  button to set.  Return to function selection mode.



Setting of [F 6] Fine adjustment of display value completed.

■[F11] Display resolution



This function is used to change the pressure display resolution.
This can be used to prevent the digits from flickering on the display.

<Operation>

Press the  or  button in function selection mode to display [F11].

Press the  button.  Move on to setting of display resolution.

Setting of display resolution

Press the  or  button to select display resolution.

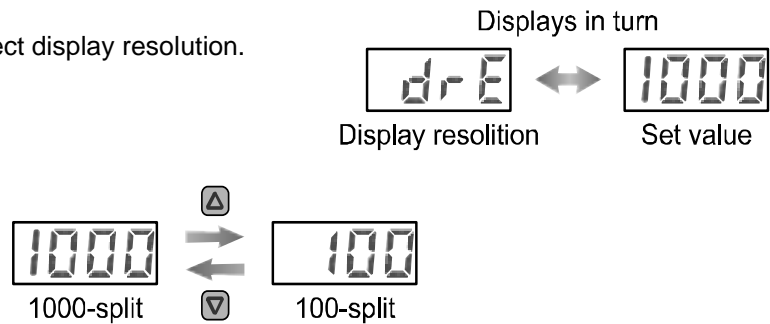

Press the  button to set.  Return to function selection mode.

Setting of [F11] Display resolution completed.

*: It may not be possible to change the resolution depending on the unit of pressure selected..

The units that allow display resolution to be selected are MPa, kPa, kgf/cm², psi and inHg.
(The units kgf/cm², bar, psi and inHg can only be set when using a product with unit conversion function.)

➡ [F 0] Unit selection function on page 22.

■ [F80] Power saving mode

Power saving mode is selectable.

When selected and no buttons are pressed for 30 seconds, the pressure switch will shift to power saving mode.

The default setting is normal mode (power saving mode off).

<Operation>

Press the or button in function selection mode to display [F80].

Press the button. Move on to setting of power saving mode.

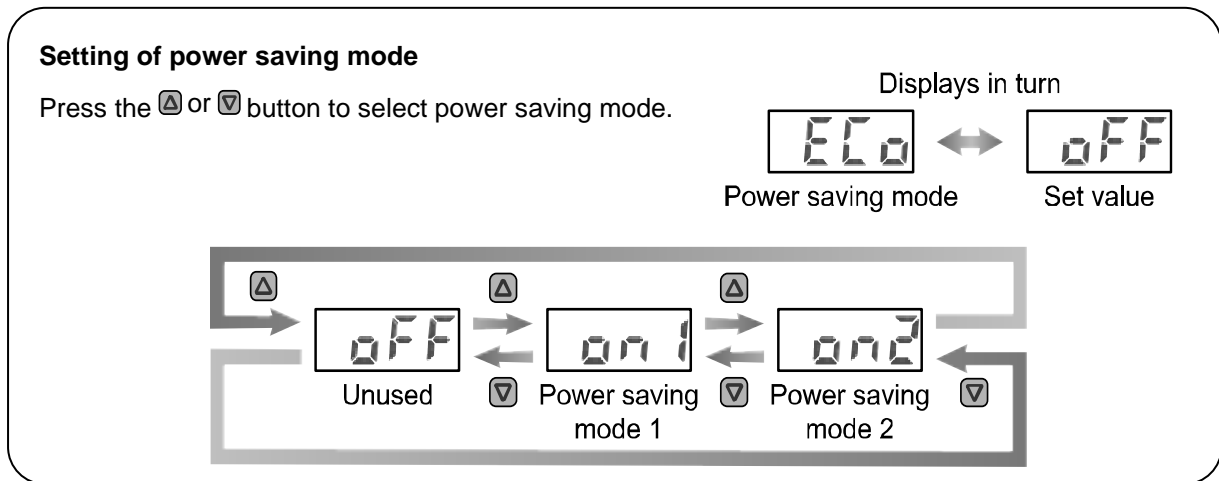

Press the button to set. Return to function selection mode.

Setting of [F80] Power saving mode completed.

Power saving mode 1 remains enabled until turned off.

In power saving mode 1, the brightness of the whole display is reduced.

In power saving mode 2, when buttons are pressed the display is normal, but if no buttons are pressed for 30 seconds, it will revert to power saving mode. (Power saving is only enabled in measurement mode).

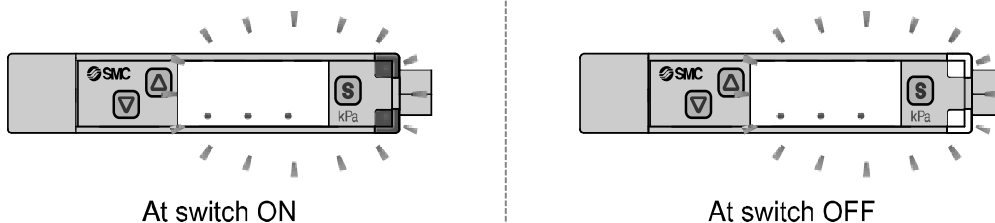

In power saving mode 2, a decimal point flashes and moves across the display.
(In saving mode 2, a decimal point flashes and moves across the display.)





■[F81] Security code



A security code can be selected, which must be entered to unlock the keys when the keys are locked. In the default setting, entry of a security code number is not required.

<Operation>

Press the  or  button in function selection mode to display [F81].

Press the  button.  Move on to setting of security code.

Setting of security code

Press the  or  button to select security code.

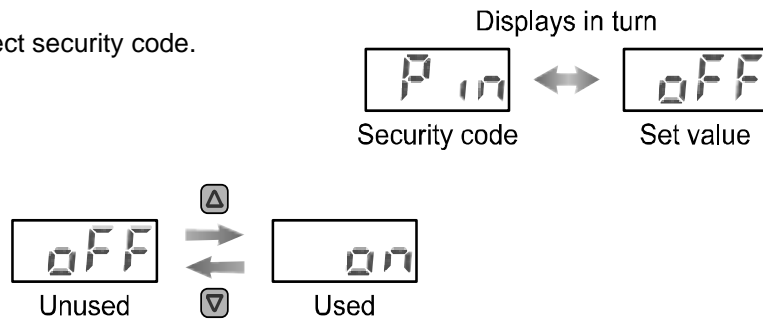

Press the  button to set.  Return to function selection mode.

Setting of [F81] Security code complete.

If the security code is used, it becomes necessary to enter the security code to release the key lock. The security code number can be set to a different value by an operator. The default setting is "000".

Refer to page [42](#) or details of operation when the security code is used.

■[F90] Setting of all functions

All functions can be set, one after the other.

<Operation>

Press the **▲** or **▼** button in function selection mode to display [F90].

Press the **S** button. ↓ Move on to setting of all functions.

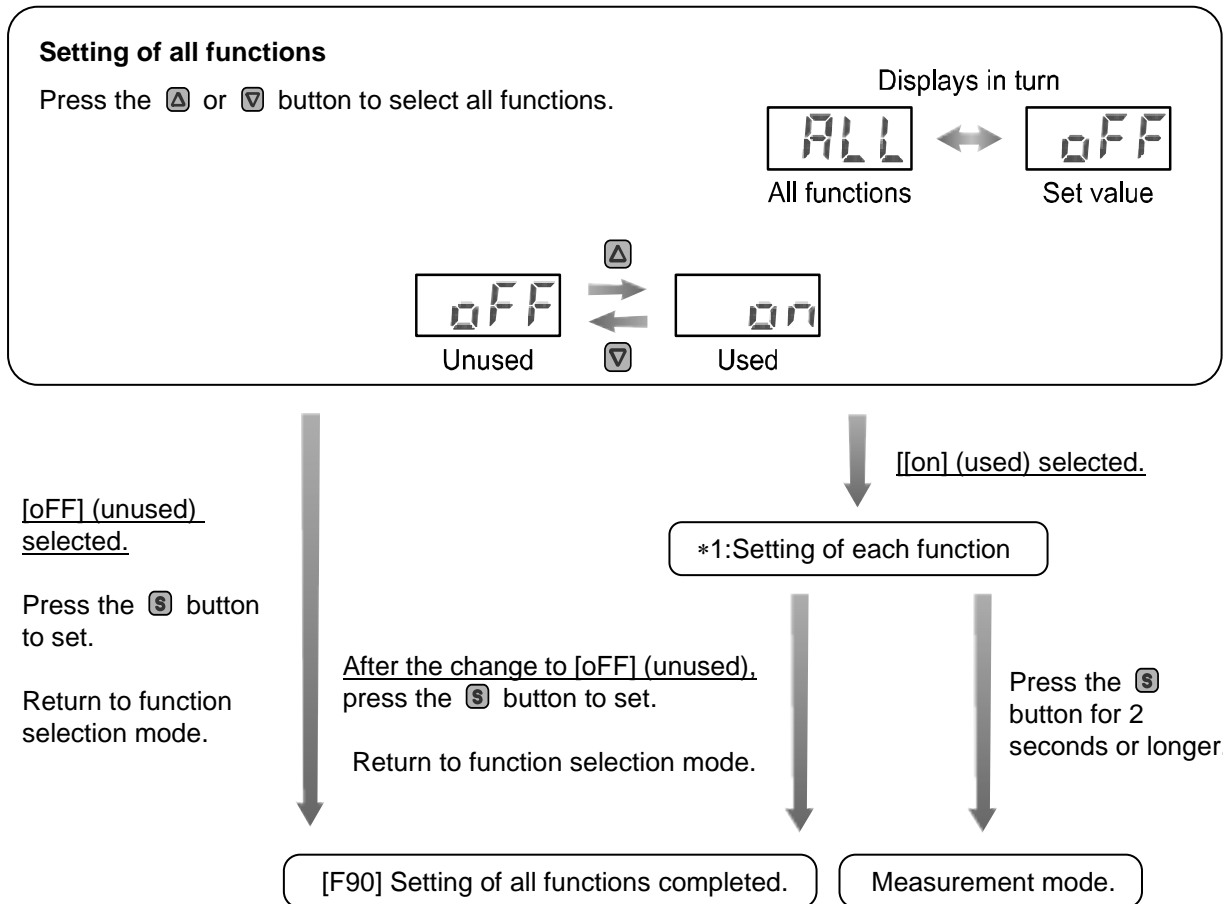

*1: Setting of functions

Every time the **S** button is pressed, the function steps in the order of "Order of function of setting" on page 35.

Set by using the **▲** or **▼** buttons.

For details of how to set each function, refer to the relevant setting of function section in this manual.

•Order of function of setting

Order	Function
1	Selection of display unit
2	Setting of output mode (OUT1)
3	Setting of reversed output (OUT1)
4	Setting of pressure (OUT1)
5	Setting of hysteresis (OUT1)
6	Setting of output mode (OUT2)
7	Supply pilot valve signal ON point
8	Supply pilot valve signal OFF point
9	Setting of hysteresis (OUT2) Set the range in which the supply pilot valve input is prohibited
10	Setting of response time
11	Setting of display resolution
12	Setting of auto-preset
13	Setting of initialization of fine adjustment of display value
14	Setting of power saving mode
15	Setting of security code

*: Return to measurement mode from any setting item by pressing the S button for 2 seconds or longer.

■[F96] Check of suction command signal

<Operation>

Press the **▲** or **▼** button in function selection mode to display [F96].

Press the **S** button. ↓ Move on to the suction signal input check.

Check of the input of suction command signal status

When suction signal is not input, "oFF" is displayed.

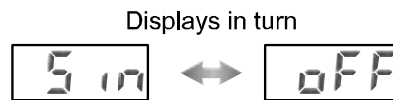

When suction signal is input, "on" is displayed.



Press the **S** button. ↓ Return to function selection mode.

[F96] Check of suction command signal completed.

■ [F98] Check of output

Output from the switch can be confirmed.
The output can be turned ON/OFF manually.

<Operation>

Press the or button in function selection mode to display [F98].

Press the button. ↓ Move on to check of output.

Output check

Press the or button to select output check.

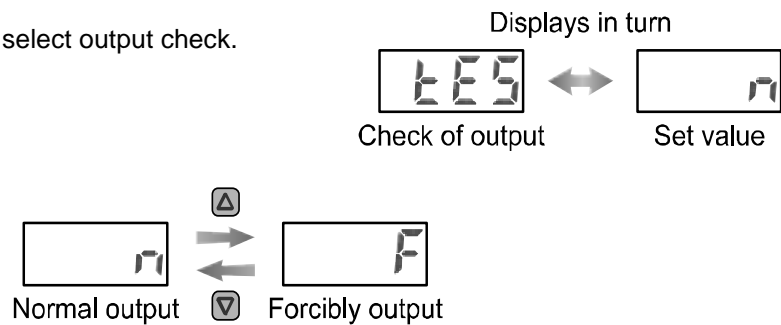

If [n] (normal output) is selected, press the button to set.

Return to function selection mode.

If [F] (forcibly output) is elected, press the button to set.

OUT1 check of output

Press the or button to select OUT1 check of output.

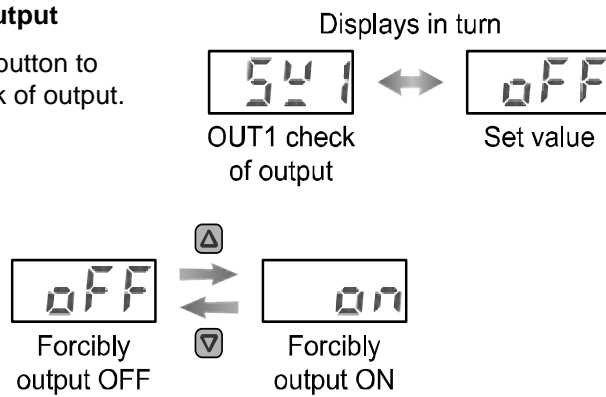

Press the button to set.

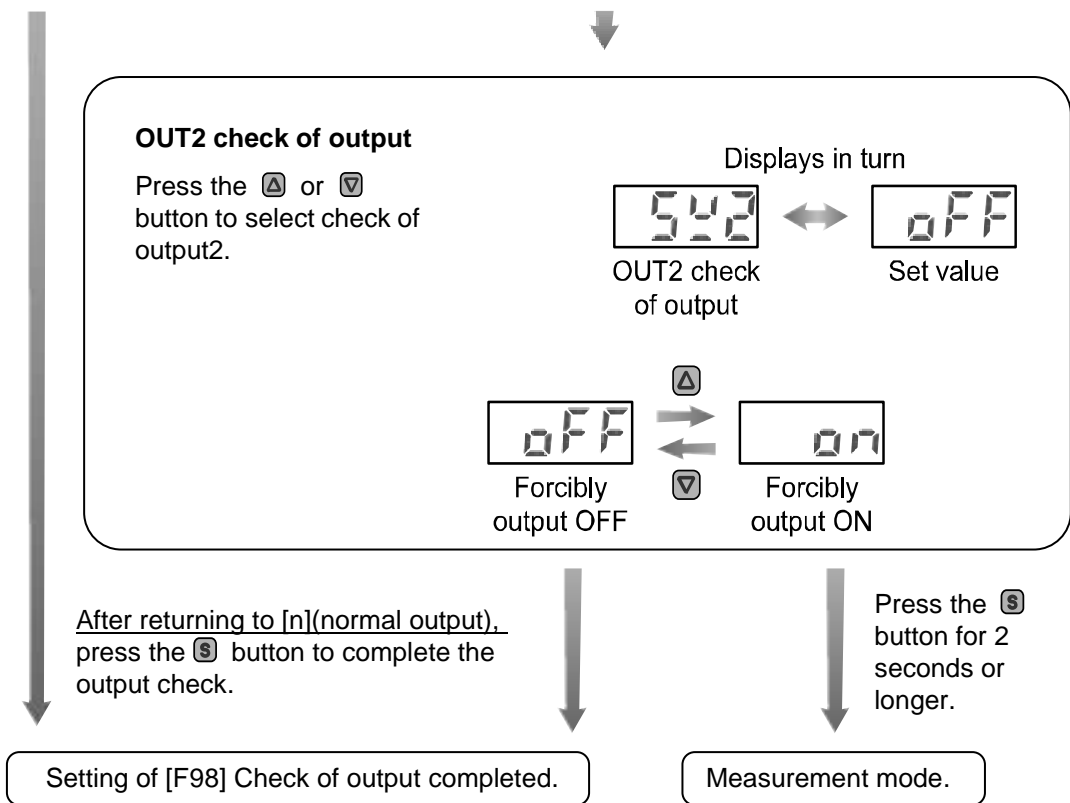





*: Return to measurement mode from any point by pressing the S button for 2 seconds or longer.

■[F99] Reset to the default setting





If the setting of the pressure switch becomes unknown, the default setting can be restored.

<Operation>

Press the  or  button in function selection mode to display [F 99].

Press the  button.  Move on to reset to the default setting.

Reset to the default setting

Set the display [ON] by pressing the  or  button, then press the  and  buttons simultaneously for 5 seconds or longer.

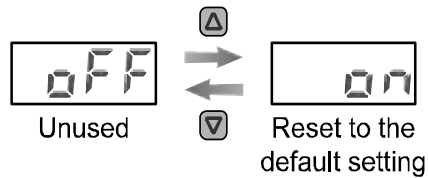

All settings are returned to the default values. Return to function selection mode.

[oFF] (unused) selected.

Press the  button to confirm selection.

Return to the function selection mode.

Setting of [F99] Reset to the default setting completed

Other Settings

○Peak/Bottom hold value display



The maximum (minimum) vacuum pressure from when the power was supplied to this moment is detected and updated.

For peak display, when the  button is pressed for 1 second or longer, the maximum vacuum pressure and "Hi" starts flashing, and is held.

To release the display of the peak pressure value, press the  button for 1 second or longer.

For bottom display, when the  button is pressed for 1 second or longer, the minimum vacuum pressure and "Lo" starts flashing and is held.

To release the display of the bottom pressure value, press the  button for 1 second or longer again to return to measurement mode.



If the  and  buttons are pressed simultaneously for 1 second or longer while the vacuum pressure is being held, the maximum (minimum) values are reset.

○Zero clear

The displayed value can be adjusted to zero when the pressure to be measured is within +/-3.5%F.S. of the zero point set at the time of shipment from the factory.

Perform zero-clear while pressure is not applied.

The zero clear range varies by $\pm 1\%$ F.S. due to variation between individual products.

When the  and  buttons are pressed for 1 second or longer simultaneously, display is reset to zero.

Measurement mode is returned to automatically.

○Key-lock function

The key lock function is used to prevent errors occurring due to unintentional changes of the set values.

If a button operation is performed while the key lock setting is ON, "LoC" is displayed for approximately 1 second.

(When the  button is pressed, the set pressure will be displayed following "LoC".)

<Operation – Without security code input>

- (1) Press and hold the  button for 5 seconds or longer in measurement mode.

The current setting "LoC" or "UnL" is displayed.

(To release key-lock, repeat the above operation)

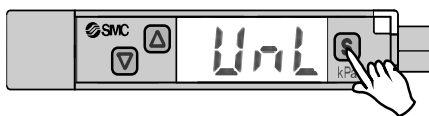

- (2) Press either the  or  button to select between locking and unlocking the keys.

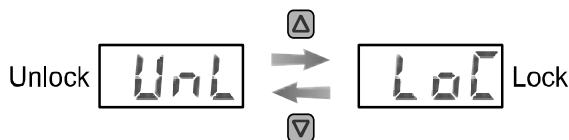

- (3) Press the  button to enter the setting.

<Operation -With security code->

•Locking

- 1, Press and hold the **[S]** button for 5 seconds or longer in measurement mode.
[UnL] is displayed.

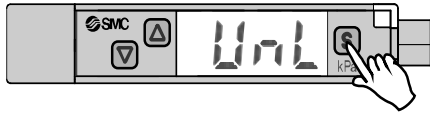

- 2, Press the **[▲]** or **[▼]** button to select locking of the keys [LoC].

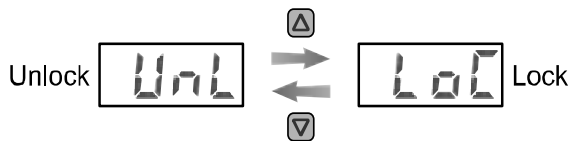

- 3, Press the **[S]** button to enter the setting.

•Unlocking

- 1, Press and hold the **[S]** button for 5 seconds or longer in measurement mode.
[LoC] is displayed.

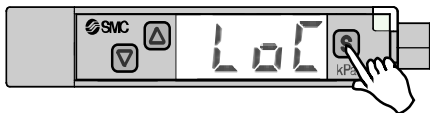

- 2, Press the **[▲]** or **[▼]** button to select locking of the keys [UnL].

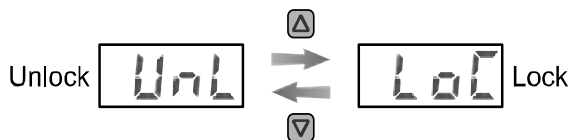

- 3, When the **[S]** button is pressed, input of the security code will be requested.
For how to enter the security code, refer to "How to entry the security code" on page 42.



- 4, If the security code entered is correct, the display changes to [UnL], and pressing any of the **[▲]**, **[S]** or **[▼]** buttons releases the key lock and returns the device to measurement mode.
If the security code entered is incorrect, [FAL] is displayed, following which the security code input screen returns.
If the wrong security code is entered 3 times, [LoC] is displayed and the device returns to measurement mode.

•How to change the security code

At the time of shipment, the security code is set to [000], but this can be changed to any number.

<Operation>

1, After the key lock setting has been completed, perform all three steps in the unlock setting procedure. (page 41, "3,").

2, After the security code is entered and the indication changes to [UnL], Press and hold the **S** and **V** buttons simultaneously for 5 seconds or longer.

[000] is displayed and the new security code should be entered.

For how to input the security code, refer to "How to input and change the security code".

The new security code will be displayed.

3, Check the new security code is as desired and press the **S** button for 1 second or longer.

Return to the measurement mode.

At this time, if the **A** or **V** button is pressed, the security code is not changed and a new security code should be entered.



•How to enter the security code

The left most digit starts flashing.

Press the **A** or **V** button to change the value.

Press the **S** button to make the next digit to the right flash.

(If the **S** button is pressed when the last digit is flashing, the left most digit starts flashing again).

After the setting is complete, Press and hold the **S** button for 1 second or longer.

(If an operation is not performed for 30 seconds during input or change of the security code, it will return to measurement mode.)

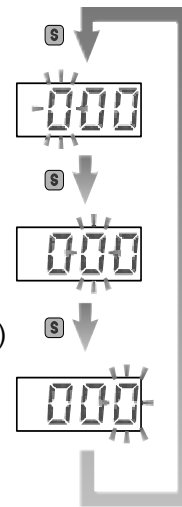

Maintenance

How to reset the product for power cut or forcible de-energizing

The setting of the product will be retained as it was before a power cut or de-energizing.

The output condition is also basically recovered to that before a power cut or de-energizing, but may change depending on the operating environment. Therefore, check the safety of the whole facility before operating the product.

If the facility is under accurate control, wait until it has warmed up. (Approximately 10 to 15 minutes)

Troubleshooting

•Troubleshooting

Applicable Pressure switch: **ZME-ZSE***-A**

If an operational failure of the pressure switch occurs, please select the cause of failure from the flow chart below.

If a cause applicable to the failure cannot be identified and normal operation can be recovered by replacement with a new pressure switch, this indicates that the pressure switch itself was faulty.

The damage to the pressure switch may have been caused by the operating environment (network construction, etc.). Consult with SMC separately to obtain countermeasures.

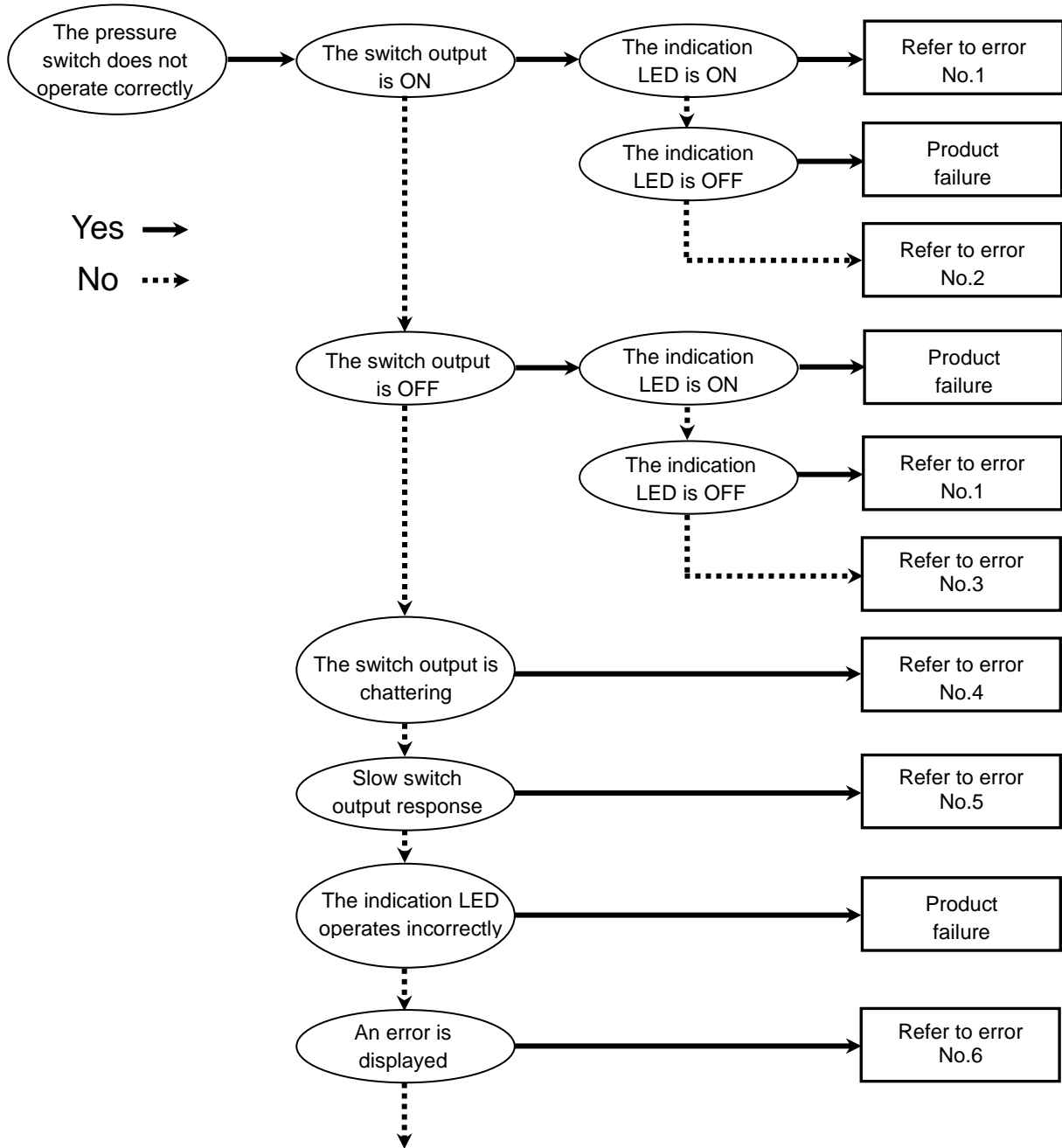

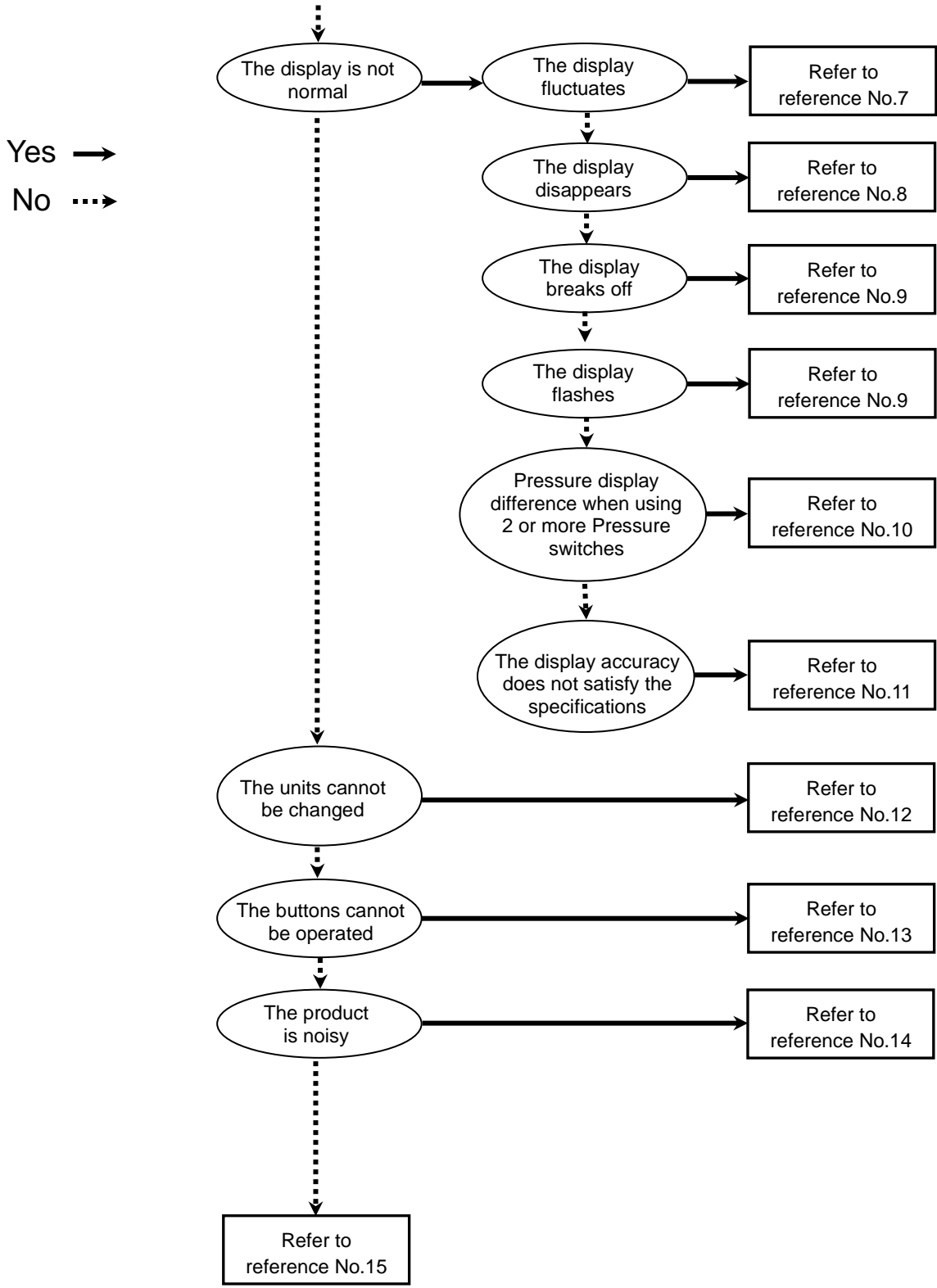

A

•Cross-reference for troubleshooting

Error No.	Problem	Possible cause	Investigation method	Countermeasure
1	<ul style="list-style-type: none"> •Output remains ON. Indication LED remains ON. •Output remains OFF. Indication LED remains OFF. 	Incorrect pressure setting	(1) Check the set pressure value. (2) Check the settings of the hysteresis and output type. (Normal output/reversed output)	(1) Reset the pressure settings. (2) Reset the function settings.
		Product failure		Replace the product.
2	Output remains ON. Indication LED works correctly.	Incorrect wiring	Check the wiring of the output. Check if the load is connected directly to DC(+) or DC(-).	Correct the wiring.
		Product failure		Replace the product.
3	Output remains OFF. Indication LED works correctly.	Incorrect wiring	Check the wiring of the output. Check if the load is connected directly to DC(+) or DC(-).	Correct the wiring.
		Unsuitable model selection	Check if PNP is used even though NPN should have been selected, or the other way around.	Review the selected model (output type).
		Broken lead wire	Check if there is bending stress applied to any parts of the lead wire. (Bending radius and tensile force applied).	Correct the wiring. (adjust the tensile force and increase the bending radius).
		Product failure		Replace the product.
4	The switch output generates chattering.	Incorrect wiring	Check the wiring. Check if the brown and blue wires are connected to DC(+) and DC(-) respectively, and if the output wiring is loose (contact failure).	Correct the wiring.
		Incorrect setting	(1) Check the pressure settings. (2) Check if the hysteresis range is too narrow. (3) Check the setting of the response time. Check if the response time is too short.	(1) Reset the pressure settings. (2) Increase the hysteresis. (3) Change the response time setting.
		Product failure		Replace the product.
5	Slow switch output response.	Incorrect pressure setting	Check the pressure settings. Check if the detected pressure and the set pressure values are the same or are too close.	Adjust the set pressure value. Ensure the set pressure value is not too close to the detected pressure value.

Error No.	Problem	Possible cause	Investigation method	Countermeasure
6	<ul style="list-style-type: none"> •An over current error (Er1, 2) is displayed. •System error (Er0, 4, 6, 7, 8 or 9) is displayed. •"HHH" is displayed. •"LLL" is displayed. •Residual pressure error (Er3) is displayed. 	Over current to the output (Er1 and 2)	<ol style="list-style-type: none"> (1) Check if the output current is 80 mA or more. (2) Check if the specified load is connected. (3) Check if a relay without a surge voltage suppressor is connected. (4) Check if the wiring is in the same route as (or bundled together with) a high-voltage or power line. 	<ol style="list-style-type: none"> (1), (2) Connect the appropriate load. (3) Use a relay with a surge voltage suppressor or take measures to prevent noise. (4) Separate the wiring from the high-voltage and/or power line.
		Incorrect internal data processing of the product (Er0, 4, 6, 7, 8 or 9)	<ol style="list-style-type: none"> (1) Check if there is noise interference (such as static electricity). (2) Check if the power supply voltage is in the range 24 VDC \pm10%. 	<ol style="list-style-type: none"> (1) Remove the noise and the noise source (or take measures to prevent noise interference), and reset the product (or turn off and then turn back on the power supply). (2) Supply power in the range 24 VDC \pm10%.
		Applied pressure is over the upper limit (HHH).	<ol style="list-style-type: none"> (1) Check that the pressure is not above the upper limit of the set pressure range. (2) Check that foreign matter has not entered the piping. 	<ol style="list-style-type: none"> (1) Reset applied pressure to a level within the set pressure range. (2) Take measures to prevent foreign matter from getting into the piping.
		Applied pressure is under the lower limit (LLL).	<ol style="list-style-type: none"> (1) Check that the pressure is not below the lower limit of the set pressure range. (2) Check that foreign matter has not entered the piping. 	<ol style="list-style-type: none"> (1) Bring the pressure back within the set pressure range. (2) Take measures to prevent foreign matter from entering the piping.
		Pressure is not atmospheric pressure at zero-clear operation (Er3).	Check that a pressure above \pm 3.5%F.S. was not applied, during zero-clear operation.	Return the applied pressure to atmospheric pressure, and retry the zero clear operation.
		Product failure		Replace the product.
		7	Displayed values fluctuates.	Incorrect power supply
Incorrect wiring	Check the power supply wiring Check if the brown and blue wires are connected to DC(+) and DC(-) respectively, and if the wiring is secure.			Correct the wiring and/or load resistance.
Factory line pressure is not stable.	Check if the factory line pressure is changing.			If the fluctuation is not acceptable, the number of digits (display sensitivity) can be reduced by changing the display resolution.

Error No.	Problem	Possible cause	Investigation method	Countermeasure
8	<ul style="list-style-type: none"> •The display turns OFF. •Part of the display is missing. 	Incorrect power supply	Check if the power supply voltage is in the range 24 VDC \pm 10%.	Supply power supply voltage of 24 VDC \pm 10%.
		Incorrect wiring	Check the power supply wiring. Check if the brown and blue wires are connected to DC(+) and DC(-) respectively, and if the wiring is secure.	Correct the wiring.
		Power saving mode	Check if power saving mode is selected.	Reset the setting of function.
		Product failure		Replace the product.
9	The display flashes.	Peak value/ bottom value display mode is selected.	Check if peak value or bottom value display mode is selected.	Turn off the peak value/bottom value display mode.
		Wiring failure	(1) Check the power supply wiring. (2) Check if bending stress is being applied to a specific part of the lead wire.	(1) Correct the wiring. (2) Correct the wiring (bending radius and stress).
10	Pressure display difference when using 2 or more Pressure switches	Dispersion within the display accuracy range	Check if the dispersion is within the display accuracy range.	Use the fine adjustment mode to adjust the display if the dispersion is within the display accuracy range.
		Product failure		Replace the product.
11	The pressure display accuracy does not meet the specifications.	Foreign matter	Check if any foreign matter has entered the pressure port.	Install a 5 μ m filter to prevent foreign matter from getting into the pressure port. Also, clean the filter regularly to prevent drainage deposits.
		Air or liquid leakage	Check if air or liquid are leaking from the piping.	Rework the piping. If the tightening torque is exceeded, the mounting screws, brackets and the pressure switch may be damaged.
		Insufficient warm-up time	Check if the product satisfies the specified accuracy 10 minutes after supplying power.	After energizing, the display and output can drift. For precise pressure detection, allow the product to warm up for 10 to 15 minutes.
		Product failure		Replace the product.
12	The display units cannot be changed.	Improper model selection (Selection of model "without unit selection function")	Check if there is a "-M" at the end of the part number printed on the product.	<p>"-M" in the part number means that the measurement unit cannot be changed. (kPa or MPa can be selected.)</p> <p>*: The unit selection function is not available in Japan due to a new measurement law.</p> <p>*: It is fixed to the SI unit "kPa", "MPa".</p>
		Product failure		Replace the product.

Error No.	Problem	Possible cause	Investigation method	Countermeasure
13	The buttons cannot be operated.	Key-lock mode is activated.	Check if the key-lock function is turned on.	Release the key-lock function.
		Product failure		Replace the product.
14	The product is noisy.	Air or liquid leakage	Check if air or liquid are leaking from the piping.	Rework the piping. If the tightening torque is exceeded, the mounting screws, brackets and the pressure switch may be damaged.
		Product failure		Replace the product.
15	Operation is unstable (chattering).	Effect of line pressure fluctuation because hysteresis is too narrow or response time is too short	(1) Check the set pressure values (hysteresis) (2) Check the response time.	(1) Widen the hysteresis. (2) Change the response time setting.
		Incorrect wiring/ broken lead wire	(1) Check the power supply wiring. (2) Check if there is bending stress applied to any parts of the lead wire. (Bending radius and tensile force applied to the lead wire)	(1) Correct the wiring and/or load resistance (2) Correct the wiring. (Reduce the tensile force or increase the bending radius.)
		Product failure		Replace the product.

■ Error Indication

This function is to display error location and content when a problem or an error occurs.

Error Name	Error Display	Error Type	Troubleshooting Method
Over current Error	Er1 Er2	The switch output load current is more than 80 mA.	Turn the power off and remove the cause of the over current. Then turn the power on.
Zero-clear Error	Er3	During the zero clear operation, pressure above $\pm 3.5\%$ F.S. has been applied. After 1 second, the mode will return to measurement mode. The zero clear range can vary $\pm 1\%$ F.S. with individual product differences.	Perform zero clear operation again after restoring the applied pressure to an atmospheric pressure condition.
Pressurizing Error	HHH	Pressure has exceeded the upper limit of the set pressure range.	Adjust the applied pressure to a level within the set pressure range.
	LLL	Pressure has exceeded the lower limit of the set pressure range.	
System Error	Er0 Er4 Er6 Er7 Er8 Er9	Displayed in the case of an internal data error.	Turn the power off and turn it on again. If resetting fails, an investigation by SMC Corporation will be required.

If the error can not be reset after the above measures are taken, then please contact SMC.

Specification

■ Specifications

Rated pressure range		100.0 to -100.0 kPa
Set pressure range		105.0 to -105.0 kPa
Proof pressure		500 kPa
Min. display unit		0.1 kPa
Applicable fluid		Air, inert gas and non-flammable gas
Power supply voltage		24 VDC $\pm 10\%$, ripple max. 10% _{opk-pk} (with polarity protection)
Current consumption		40 mA or less
Switch Output		NPN or PNP open collector OUT1: General-purpose、OUT2: Valve control
	Maximum load current	80 mA
	Max. applied voltage	DC26.4 V
	Residual voltage	Max. 2 V (at 80 mA load current)
	Response time	2.5 ms or less (response times available for anti-chattering function: 20, 100, 500, 1000 or 2000 ms)
	Short circuit protection	Provided
Repeatability		$\pm 0.2\%F.S. \pm 1$ digit
Hysteresis	Hysteresis mode	Adjustable (can be set from 0) *1
Display		3 1/2 digits, 7-segment display, colour display (Red)
Indicator accuracy		$\pm 2\%F.S.$, ± 1 digit (at ambient temperature 25 ± 3 °C)
Indication LED		Light when ON OUT1: Green OUT2: Red
Environment	Enclosure	IP40
	Ambient temperature range	5 to 50 °C
	Withstand voltage	1000 VAC for 1 minute between live parts and case insulation resistance
	Insulation resistance	50 M Ω or more at 500 VDC Between lead block and case
Temperature characteristic		$\pm 2\%F.S.$ (25 °C reference)
Lead wire		cable 5 cores ϕ 3.5, 2 m Sectional area of conductor: 0.15 mm ² (AWG26) Outside diameter of insulator: 1.0 mm
Standard		CE/UKCA MARKED, RoHS

*1: If the applied pressure fluctuates around the set value, the hysteresis must be set to a value more than the amount of fluctuation or chattering will occur.

B

Revision history

- A: Document number change.
Safety instructions layout modification.
Mounting and installation update figure.
wiring update figure.
Easy setting change display display to show the number.
[F2] setting of OUT2 corrected operation.
Removal of discriminatory expressions.
Shorten the start-up time.
Elimination copy function.
- B: UKCA marking added

SMC Corporation

4-14-1, Sotokanda, Chiyoda-ku, Tokyo 101-0021 JAPAN

Tel: + 81 3 5207 8249 Fax: +81 3 5298 5362

URL <https://www.smcworld.com>

Note: Specifications are subject to change without prior notice and any obligation on the part of the manufacturer.

© 2011-2022 SMC Corporation All Rights Reserved

