



# Operation Manual

**3 Port Solenoid Valve**

PRODUCT NAME

**V100 Series**

MODEL/ Series

**SMC Corporation**

# Contents

Safety Instructions .....	2,3
Design / Selection .....	4,5
Mounting .....	5
Piping .....	6
Wiring .....	6
Lubrication .....	7
Air Supply .....	7
Operating Environment .....	7
Maintenance .....	8
UL approved product .....	8
Specific Product Precautions .....	9,10
Trouble shooting .....	11,12



# Safety Instructions

These safety instructions are intended to prevent hazardous situations and/or equipment damage. These instructions indicate the level of potential hazard with the labels of "Caution," "Warning" or "Danger." They are all important notes for safety and must be followed in addition to International Standards (ISO/IEC)\*1), and other safety regulations.

\*1) ISO 4414: Pneumatic fluid power -- General rules relating to systems.

ISO 4413: Hydraulic fluid power -- General rules relating to systems.

IEC 60204-1: Safety of machinery -- Electrical equipment of machines .(Part 1: General requirements)

ISO 10218: Manipulating industrial robots -Safety.

etc.



## Caution

**Caution** indicates a hazard with a low level of risk which, if not avoided, could result in minor or moderate injury.



## Warning

**Warning** indicates a hazard with a medium level of risk which, if not avoided, could result in death or serious injury.



## Danger

**Danger** indicates a hazard with a high level of risk which, if not avoided, will result in death or serious injury.

## Warning

### 1. The compatibility of the product is the responsibility of the person who designs the equipment or decides its specifications.

Since the product specified here is used under various operating conditions, its compatibility with specific equipment must be decided by the person who designs the equipment or decides its specifications based on necessary analysis and test results.

The expected performance and safety assurance of the equipment will be the responsibility of the person who has determined its compatibility with the product.

This person should also continuously review all specifications of the product referring to its latest catalog information, with a view to giving due consideration to any possibility of equipment failure when configuring the equipment.

### 2. Only personnel with appropriate training should operate machinery and equipment.

The product specified here may become unsafe if handled incorrectly.

The assembly, operation and maintenance of machines or equipment including our products must be performed by an operator who is appropriately trained and experienced.

### 3. Do not service or attempt to remove product and machinery/equipment until safety is confirmed.

1. The inspection and maintenance of machinery/equipment should only be performed after measures to prevent falling or runaway of the driven objects have been confirmed.

2. When the product is to be removed, confirm that the safety measures as mentioned above are implemented and the power from any appropriate source is cut, and read and understand the specific product precautions of all relevant products carefully.

3. Before machinery/equipment is restarted, take measures to prevent unexpected operation and malfunction.

### 4. Contact SMC beforehand and take special consideration of safety measures if the product is to be used in any of the following conditions.

1. Conditions and environments outside of the given specifications, or use outdoors or in a place exposed to direct sunlight.

2. Installation on equipment in conjunction with atomic energy, railways, air navigation, space, shipping, vehicles, military, medical treatment, combustion and recreation, or equipment in contact with food and beverages, emergency stop circuits, clutch and brake circuits in press applications, safety equipment or other applications unsuitable for the standard specifications described in the product catalog.

3. An application which could have negative effects on people, property, or animals requiring special safety analysis.

4. Use in an interlock circuit, which requires the provision of double interlock for possible failure by using a mechanical protective function, and periodical checks to confirm proper operation.



# Safety Instructions

## Caution

### **1. The product is provided for use in manufacturing industries.**

The product herein described is basically provided for peaceful use in manufacturing industries. If considering using the product in other industries, consult SMC beforehand and exchange specifications or a contract if necessary.  
If anything is unclear, contact your nearest sales branch.

## **Limited warranty and Disclaimer/Compliance Requirements**

The product used is subject to the following “Limited warranty and Disclaimer” and “Compliance Requirements”.

Read and accept them before using the product.

### **Limited warranty and Disclaimer**

**1. The warranty period of the product is 1 year in service or 1.5 years after the product is delivered, whichever is first.\*2)**

**Also, the product may have specified durability, running distance or replacement parts. Please consult your nearest sales branch.**

**2. For any failure or damage reported within the warranty period which is clearly our responsibility, a replacement product or necessary parts will be provided.**

**This limited warranty applies only to our product independently, and not to any other damage incurred due to the failure of the product.**

**3. Prior to using SMC products, please read and understand the warranty terms and disclaimers noted in the specified catalog for the particular products.**

**\*2) Vacuum pads are excluded from this 1 year warranty.**

**A vacuum pad is a consumable part, so it is warranted for a year after it is delivered.**

**Also, even within the warranty period, the wear of a product due to the use of the vacuum pad or failure due to the deterioration of rubber material are not covered by the limited warranty.**

### **Compliance Requirements**

**1. The use of SMC products with production equipment for the manufacture of weapons of mass destruction(WMD) or any other weapon is strictly prohibited.**

**2. The exports of SMC products or technology from one country to another are governed by the relevant security laws and regulation of the countries involved in the transaction. Prior to the shipment of a SMC product to another country, assure that all local rules governing that export are known and followed.**

## Caution

**SMC products are not intended for use as instruments for legal metrology.**

Measurement instruments that SMC manufactures or sells have not been qualified by type approval tests relevant to the metrology (measurement) laws of each country.

Therefore, SMC products cannot be used for business or certification ordained by the metrology (measurement) laws of each country.



## Design / Selection

**Warning****1. Confirm the specifications**

Products represented in this instruction manual are designed only for use in compressed air systems (including vacuum). Do not operate at pressures or temperatures, etc., beyond the range of specifications, as this can cause damage or malfunction. (Refer to the specifications.) Please contact SMC when using a fluid other than compressed air (including vacuum). We do not guarantee against any damage if the product is used outside of the specification range.

**2. Actuator drive**

When an actuator, such as a cylinder, is to be driven using a valve, take appropriate measures (cover installation or approach prohibition) to prevent potential danger caused by actuator operation.

**3. Effect of back pressure when using a manifold.**

Use caution when valves are used on a manifold, because an actuator may malfunction due to back-pressure.

**4. Holding pressure (including vacuum).**

Since the valve are subject to air leakage, they cannot be used for applications such as holding pressure (including vacuum) in a pressure vessel.

**5. Not suitable for use as an emergency shut-off valve, etc.**

The valves listed in this instruction manual are not designed for safety applications such as an emergency shutoff valve. If the valves are used for the mentioned applications, additional safety measures should be adopted.

**6. Release of residual pressure**

For maintenance purposes install a system for releasing residual pressure.

**7. Operation in a vacuum condition**

When a valve is used for switching a vacuum, take measures to install a suction filter or similar to prevent external dust or other foreign matter from entering inside the valve. In addition, at the time of vacuum adsorption, be sure to supply a constant supply of vacuum. Failure to do so may result in foreign matter sticking to the adsorption pad or air leakage, causing the workpiece to drop.

**8. Regarding a vacuum switch valve**

For maintenance purposes install a system for releasing residual pressure.

**9. Ventilation**

Provide ventilation when using a valve in a confined area, such as in a closed control panel. For example, install a ventilation opening, etc. in order to prevent pressure from increasing inside of the confined area and to release the heat generated by the valve.

**10. Extended periods of continuous energization.**

If a valve will be continuously energized for an extended period of time, the temperature of the valve will increase due to the heat generated by the coil assembly. This will likely adversely affect the performance of the valve and any nearby peripheral equipment. Therefore, if the valve is to be energized for periods of longer than 30 minutes at a time or if during the hours of operation the energized period per day is longer than the de-energized period, we advise using a valve with specifications listed below.

· Pilot operated: A 0.4 W or lower valve, such as the SY series, or a valve with a power-saving circuit

**11. Do not disassemble the product or make any modifications, including additional machining.**

It may cause human injury and/or an accident.

**Caution****1. Leakage voltage**

Take note that the leakage voltage will increase when a resistor is used in parallel with a switching element or when a C-R circuit (surge voltage suppressor) is used for protecting a switching device because of the leakage voltage passing through the C-R circuit. The suppressor residual leakage voltage should be as follows.

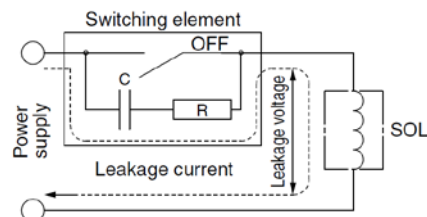

**DC coil** 3% or less of the rated voltage

**AC coil** 8% or less of the rated voltage

**2. Solenoid valve drive for AC with a solid state output (SSR, TRIAC output, etc.)****1) Current leakage**

When using a snubber circuit (C-R element) for surge protection of the output, a very small amount of electrical current will continue to flow even during the OFF state. This results in the valve not returning. In a situation where the tolerance is exceeded, as in the above case, take measures to install a bleeder resistor.

**2) Minimum allowable load amount (Min. load current)**

When the consumption current of a valve is less than the output's minimum allowable load volume or the margin is small, the output may not switch normally. Please contact SMC.

**3) Solenoid valve with full wave rectifier circuit**

When the solenoid valve built-in full wave rectifier circuit with AC specifications is used, a return failure of the solenoid valve may occur depending on the kind of triac output circuit. Carefully check this point when selecting a SSR or sequencer. For details, contact the SSR or sequencer manufacturer.

**3. Surge voltage suppressor**

1) The surge voltage suppressor built into the valve is intended to protect the output contacts so that the surge generated inside valve does not adversely affect the output contacts. Therefore, if an overvoltage or overcurrent is received from an external peripheral device, the surge voltage protection element inside the valve is overloaded, causing the element to break. In the worst case, the breakage causes the electric circuit to enter short-circuit status. If energizing continues while in this state, a large current flows. This may cause secondary damage to the output circuit, external peripheral device, or valve, and may also cause a fire. So, take appropriate protective measures, such as the installation of an overcurrent protection circuit in the power supply or a drive circuit to maintain a sufficient level of safety.

2) If a surge protection circuit contains nonstandard diodes, such as Zener diodes or varistor, a residual voltage that is in proportion to the protective circuit and the rated voltage will remain. Therefore, take into consideration the surge voltage protection of the controller. In the case of diodes, the residual voltage is approximately 1V.



## V100 Series

# Precautions for 3 Port Solenoid Valve 2

Be sure to read before handling.

### Design / Selection

#### ⚠ Caution

##### 4. Surge voltage intrusion

With non-polar type solenoid valves, at times of sudden interruption of the loading power supply, such as emergency shutdown, surge voltage intrusion may be generated from loading equipment with a large capacity (power consumption), and a solenoid valve in a de-energized state may switch over (see Figure 1).

When installing a breaker circuit for the loading power supply, consider using a solenoid valve with polarity (with polarity protection diode), or install a surge absorption diode between the loading equipment COM line and the output equipment COM line (see Figure 2).

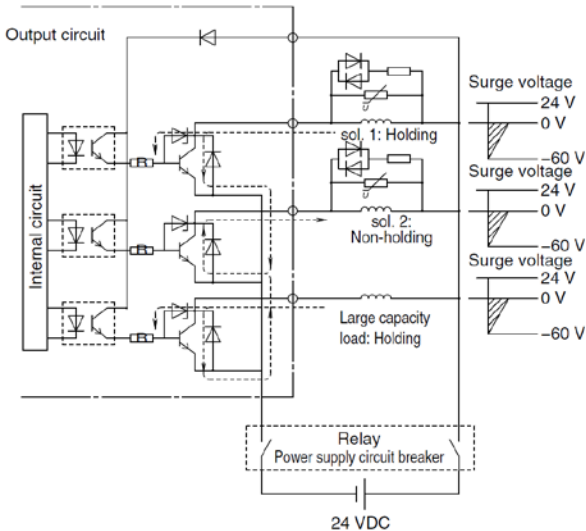

Figure 1. Surge intrusion circuit example (NPN outlet example)

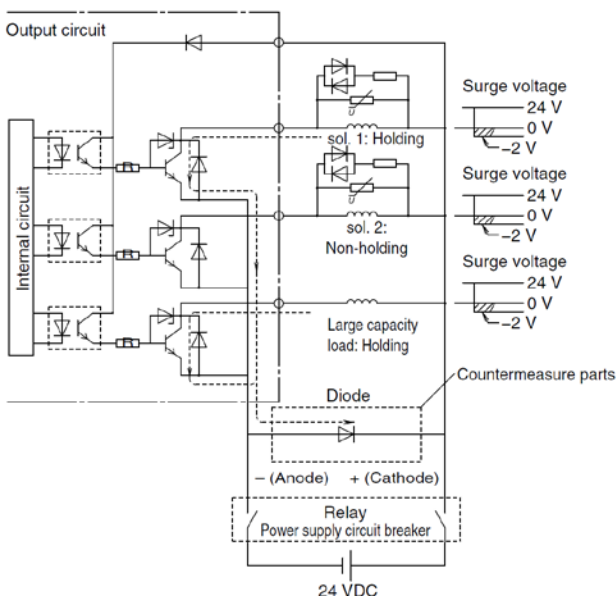

Figure 2. Surge intrusion countermeasure example (NPN outlet example)

##### 5. Operation in low temperature conditions

It is possible to operate a valve in extreme temperatures, as low as  $-10^{\circ}\text{C}$ . Take appropriate measures to avoid the freezing of drainage, moisture, etc., in low temperatures.

##### 6. In case of extremely low differential pressure between the inlet side and the outlet side. (0.001 MPa or less as a guide).

Note that air may not be output or the flow rate may deteriorate excessively due to the quality of the lubricant and air in the solenoid valve (mixing in of the drain, etc.).

##### 7. Mounting orientation

Refer to the specifications of each series.

Please consult with SMC for models not indicated in the specification column.

### Mounting

#### ⚠ Warning

##### 1. Operation manual

Install the products and operate them only after reading the operation manual carefully and understanding its contents. Also, keep the manual where it can be referred to as necessary.

##### 2. Ensure sufficient space for maintenance activities.

When installing the products, allow access for maintenance and inspection.

##### 3. Tighten threads with the proper tightening torque.

When installing the products, follow the listed torque specifications.

##### 4. If air leakage increases or equipment does

not operate properly, stop operation.

Check mounting conditions when air and power supplies are connected. Initial function and leakage tests should be performed after installation.

##### 5. Painting and coating

Warnings or specifications printed on or affixed to the product should not be erased, removed, or covered up.

Please consult with SMC before applying paint to resinous parts, as this may have an adverse effect due to the solvent in the paint.



## V100 Series

# Precautions for 3 Port Solenoid Valve 3

Be sure to read before handling.

### Piping

#### ⚠ Caution

##### 1. Refer to the Fittings and Tubing Precautions for handling One-touch fittings.

##### 2. Preparation before piping

Before piping is connected, it should be thoroughly blown out with air (flushing) or washed to remove chips, cutting oil, and other debris from inside the pipe.

##### 3. Winding of sealant tape

When screwing piping or fittings into ports, ensure that chips from the pipe threads or sealing material do not enter the piping. Also, if sealant tape is used, leave 1 thread ridge exposed at the end of the threads.

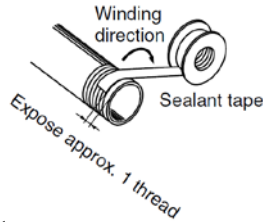

##### 4. Connection of piping and fittings

When screwing piping or fittings into the valve, tighten them as follows.

- 1) When using SMC's M5 fittings, follow the procedures below to tighten them.
  - **Connection thread: M5**  
First, tighten by hand, then use a suitable wrench to tighten the hexagonal portion of the body an additional 1/6 to 1/4 turn. The reference value for the tightening torque is 1 to 1.5 N·m
  - \* Excessive tightening may damage the thread portion or deform the gasket and cause air leakage. Insufficient tightening may loosen the threads or cause air leakage.
  - **When using a fitting other than an SMC fitting, follow the instructions given by the fitting manufacturer.**
- 2) For a fitting with sealant R or NPT, first, tighten it by hand, then use a suitable wrench to tighten the hexagonal portion of the body an additional two or three turns. For the tightening torque, refer to the table below.

Connection thread size (R, NPT)	Proper tightening torque (N·m)
1/8	3 to 5
1/4	8 to 12
3/8	15 to 20
1/2	20 to 25
3/4	28 to 30
1	36 to 38
1 1/4	40 to 42
1 1/2	48 to 50
2	48 to 50

- 3) If the fitting is tightened with excessive torque, a large amount of sealant will seep out. Remove the excess sealant.
- 4) Insufficient tightening may cause seal failure or loosen the threads.

##### 5) For reuse

- (1) Normally, fittings with a sealant can be reused up to 2 to 3 times.
- (2) To prevent air leakage through the sealant, remove any loose sealant stuck to the fitting by blowing air over the threaded portion.
- (3) If the sealant no longer provides effective sealing, wind sealing tape over the sealant before reusing. Do not use any form of sealant other than the tape type of sealant.
- (4) Once the fitting has been tightened, backing it out to its original position often causes the sealant to become defective. Air leakage will occur.

##### 5. Piping to products

When piping to a product, refer to the operation manual to avoid mistakes regarding the supply port, etc.

### Wiring

#### ⚠ Warning

1. **The solenoid valve is an electrical product. For safety, install an appropriate fuse and circuit breaker before use.**

#### ⚠ Caution

##### 1. Polarity

When connecting power to a solenoid valve with a DC specification and a light or surge voltage suppressor, check for polarity. If there is polarity, take note of the following.

##### **Without diode to protect polarity:**

If a mistake is made regarding the polarity, damage may occur to the diode in the valve, the switching element in the control device, power supply equipment, etc.

##### **With diode to protect polarity:**

If the polarity connection is wrong, the valve will not operate.

##### 2. Applied voltage

When electric power is connected to a solenoid valve, be careful to apply the proper voltage. Improper voltage may cause malfunction or coil damage.

##### 3. Check the connections.

Check if the connections are correct after completing all wiring.

##### 4. External force applied to the lead wire

If an excessive force is applied to the lead wire, this may cause faulty wiring. Take appropriate measures so that a force of 30 N or more is not applied to the lead wire. When instructions are given in the Specific Product Precautions, follow these specifications.



## V100 Series

# Precautions for 3 Port Solenoid Valve 4

Be sure to read before handling.

### Lubrication

#### Warning

##### 1. Lubrication

These valves can be used without lubrication. If a lubricant is used in the system, use class 1 turbine oil (no additives), ISO VG32. For details about lubricant manufacturers' brands, refer to the SMC website. Once lubricant is utilized within the system, since the original lubricant applied within the product during manufacturing will be washed away, please continue to supply lubrication to the system. Without continued lubrication, malfunctions could occur. If turbine oil is used, refer to the Safety Data Sheet (MSDS) of the oil.

##### 2. Lubrication amount

If the lubrication amount is excessive, the oil may accumulate inside the pilot valve, causing malfunction or response delay. So, do not apply a large amount of oil.

### Air Supply

#### Warning

##### 1. Type of fluids

Please consult with SMC when using the product in applications other than compressed air.

##### 2. When there is a large amount of drainage

Compressed air containing a large amount of drainage can cause the malfunction of pneumatic equipment. An air dryer or water separator should be installed upstream from filters.

##### 3. Drain flushing

If condensation in the drain bowl is not emptied on a regular basis, the bowl will overflow. This may cause the malfunction of pneumatic equipment. If the drain bowl is difficult to check and remove, the installation of a drain bowl with an auto drain option is recommended. For compressed air quality, refer to the SMC Best Pneumatics No. 6 catalog.

##### 4. Use clean air.

Do not use compressed air that contains chemicals, synthetic oils that include organic solvents, salt, corrosive gases, etc., as it can cause damage or malfunction.

#### Caution

##### 1. When extremely dry air is used as the fluid, degradation of the lubrication properties inside the equipment may occur, resulting in reduced reliability (or reduced service life) of the equipment. Please consult with SMC.

##### 2. Install an air filter.

Install an air filter upstream near the valve. Select an air filter with a filtration size of 5 µm or smaller.

##### 3. Take measures to ensure air quality, such as by installing an aftercooler, air dryer, or water separator.

Compressed air that contains a large amount of drainage can cause the malfunction of pneumatic equipment, such as valves. Therefore, take appropriate measures to ensure air quality, such as by providing an aftercooler, air dryer, or water separator.

##### 4. If an excessive amount of carbon powder is present, install a mist separator on the upstream side of the valve.

If excessive carbon dust is generated by the compressor, it may adhere to the inside of a valve and cause it to malfunction. For compressed air quality, refer to the SMC Best Pneumatics No. 6 catalog.

### Operating Environment

#### Warning

##### 1. Do not use in an atmosphere containing corrosive gases, chemicals, sea water, water, water steam, or where there is direct contact with any of these.

##### 2. Do not use in an environment where flammable gas or explosive gas exists. Usage may cause a fire or explosion. The products do not have an explosion proof construction.

##### 3. Do not use in a place subject to heavy vibration and/or shock.

##### 4. The valve should not be exposed to prolonged sunlight. Use a protective cover. Note that the valve is not for outdoor use.

##### 5. Remove any sources of excessive heat.

##### 6. If it is used in an environment where there is possible contact with oil, weld spatter, etc., exercise preventive measures.

##### 7. When the solenoid valve is mounted in a control panel or it's energized for a long period of time, make sure the ambient temperature is within the specifications of the valve.

#### Caution

##### 1. Temperature of ambient environment

Use the valve within the range of the ambient temperature specification of each valve. In addition, pay attention when using the valve in environments where the temperature changes drastically.

##### 2. Humidity of ambient environment

- When using the valve in environments with low humidity, take measures to prevent static.
- If the humidity rises, take measures to prevent the adhesion of water droplets on the valve.





## V100 Series

# Precautions for 3 Port Solenoid Valve 5

Be sure to read before handling.

### Maintenance

#### Warning

- 1. Perform maintenance and inspection according to the procedures indicated in the operation manual.**  
If handled improperly, human injury and/or malfunction or damage of machinery and equipment may occur.
- 2. Removal of equipment, and supply/exhaust of compressed air.**  
Before components are removed, first confirm that measures are in place to prevent workpieces from dropping, run-away equipment, etc. Then, cut off the supply air and electric power, and exhaust all air pressure from the system using the residual pressure release function.  
When the equipment is operated after remounting or replacement, first confirm that measures are in place to prevent the lurching of actuators, etc. Then, confirm that the equipment is operating normally.
- 3. Low-frequency operation**  
Valves should be operated at least once every 30 days to prevent malfunction. (Use caution regarding the air supply.)
- 4. Manual override**  
When a manual override is operated, connected equipment will be actuated. Operate only after safety is confirmed.
- 5. If the volume of air leakage increases or the valve does not operate normally, do not use the valve. Perform periodic maintenance on the valve to confirm the operating condition and check for any air leakage.**

#### Warning

- 1. Drain flushing**  
Remove drainage from the air filters regularly.
- 2. Lubrication**  
In the case of rubber seals, once lubrication has been started, it must be continued.  
Use class 1 turbine oil (with no additives), ISO VG32. If other lubricant oil is used, it may cause a malfunction. Please contact SMC for information on the suggested class 2 turbine oil (with additives), ISO VG32.

### UL approved product

#### Warning

When conformity to UL is required, the SI unit should be used with a UL 1310 Class 2 power supply.  
The SI unit is a UL approved product only if they have a





## V100 series

# Specific Product Precautions 1

Be sure to read this before handling the products.

### Manual Override Operation

#### Warning

Since connected equipment will be actuated when the manual override is operated, first confirm that conditions are safe.

- **Non-locking push type**  
[Standard type]  
Press in the direction of the arrow
- **Locking slotted type**  
[B type]  
Turn in the direction of arrow.

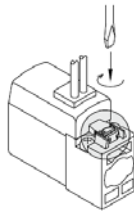
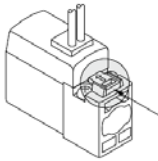

#### Caution

When operating with a screw driver, turn it gently using a watchmakers' screw driver. [Torque: less than 0.1Nm]

### How to Use of Plug Connector

#### Caution

##### 1. Attaching and detaching connectors

- To attach a connector, hold the lever and connector unit between your fingers and insert straight onto the pins of the solenoid valve so that the lever's pawl is pushed into the groove and locks.
- To detach a connector, remove the pawl from the groove by pushing the lever downward with your thumb, and pull the connector straight out.

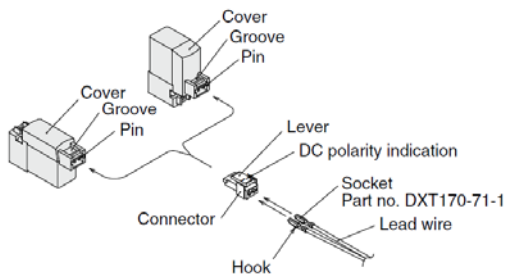

##### 2. Crimping of lead wires and sockets

Strip 3.2 to 3.7 mm at the end of the lead wires, insert the ends of the core wires evenly into the sockets, and then crimp with a crimping tool. When this is done, take care that the coverings of the lead wires do not enter the core wire crimping area. Use special tool when crimping. (Consult with SMC for the crimping tool.)

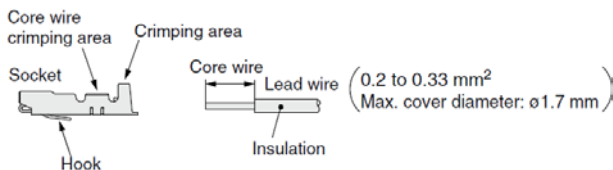

##### 3. Attaching and detaching lead wires with sockets

- **Attaching**  
Insert the sockets into the square holes of the connector ( ⊕ ⊖ indication), and continue to push the sockets all the way in until they lock by hooking into the seats in the connector. (When they are pushed in, their hooks open and they are locked automatically.) Then confirm that they are locked by pulling lightly on the lead wires.
- **Detaching**  
To detach a socket from a connector, pull out the lead wire while pressing the socket's hook with a stick having a thin tip (about 1 mm). If the socket will be used again, first spread the hook outward.

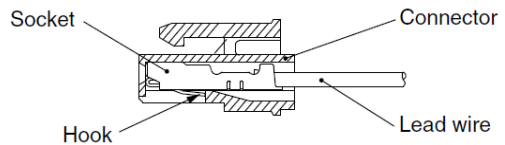

### Plug Connector Lead Wire Length

Standard length is 300 mm, but the following length is also available.

#### How to Order Connector Assembly

For DC: **SY100-30-4A-** [ ]

For 100 VAC: **SY100-30-1A-** [ ]

For 200 VAC: **SY100-30-2A-** [ ]

For other voltages of AC: **SY100-30-3A-** [ ]

Without lead wire: **SY100-30-A**

(with connector and 2 sockets)

#### How to Order

To order a valve with lead wire length of other than 300 mm, indicate part numbers of the valve without connector and the required connector assembly separately.

<Example> Lead wire length 2000 mm

For DC: **V114-5LO**      For AC: **V114A-1LO**  
**SY100-30-4A-20**      **SY100-30-1A-20**

#### Lead wire length

Nil	300 mm
6	600 mm
10	1000 mm
15	1500 mm
20	2000 mm
25	2500 mm
30	3000 mm
50	5000 mm

### SMC's Lead Wire Specifications

Cover diameter: 1.55 mm

Conductor area: 0.3 mm<sup>2</sup> (AWG22 equivalent)



## V100 series

# Specific Product Precautions 2

Be sure to read this before handling the products.

### Surge Voltage Suppressor

<For DC>

Grommet, L and M Plug Connector



#### Standard type (with polarity) With surge voltage suppressor (□S)

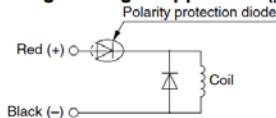

#### With light/surge voltage suppressor (□Z)

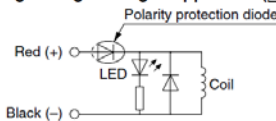

#### Non-polar type With surge voltage suppressor (□R)

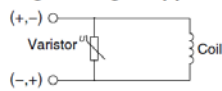

#### With light/surge voltage suppressor (□U)

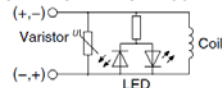

- Please connect correctly the lead wires to + (positive) and - (negative) indications on the connector.
- For DC voltages other than 12, 24 VDC, incorrect wiring will cause damage to the surge voltage suppressor circuit since a diode to prevent reverse current is not provided. (Wrong polarity will cause trouble.)
- Solenoids, whose lead wires have been pre-wired: positive side red and negative side black.

#### With power saving circuit

Power consumption is reduced by approximately 75% compared with the standard product by eliminating the need for electrical current for holding. (Effective after more than 62 ms energized and 24 VDC rated voltage applied.)

#### Electric circuit (with power saving circuit) For Single Solenoid

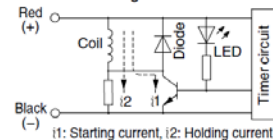

### Operating Principle

The electrical circuit as shown above, allows reduced holding current consumption and measures power saving. Refer to the electric waveform on the right.

- Please be careful not to reverse the polarity, since a diode to prevent the reversed current is not provided for the power saving circuit.

<For AC>

Grommet, L and M Plug Connector

#### With light (□Z)

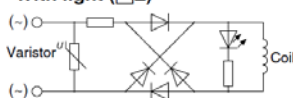

## Caution

In the case of varistor surge voltage suppressor, note the surge voltage to be suppressed at controller side as there will be a residual voltage according to the protective element and rated voltage. Moreover, the residual voltage of the diode is approximately 1 V.

### Connector Assembly with Cover

Connector assembly with protective cover enhances dust protection

- Effective in preventing possible short circuit problems due to contaminants in contact with connector section.
- Cover material is chloroprene rubber which has excellent weatherability and electric insulation properties. However, be careful not to allow contact with cutting oil, etc.
- Round cord provides neat appearance.

### How to order

SY100 - 68 - A - □

#### Lead wire length (L)

Nil	300 mm
6	600 mm
10	1000 mm
15	1500 mm
20	2000 mm
25	2500 mm
30	3000 mm
50	5000 mm

### Connector Assembly with Cover/Dimensions

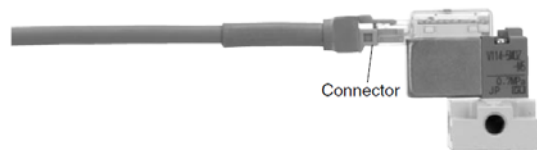
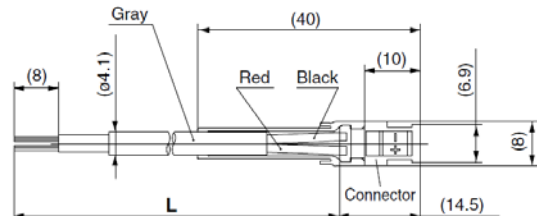

#### How to Order

Indicate part number of connector assembly with cover in addition to the solenoid valve part number without connector of the plug connector.

<Example 1> Lead wire length: 2000 mm

V114-5LOZ-M5

SY100-68-A-20

<Example 2> Lead wire length: 300 mm (Standard)

V114-5LPZ-M5

Symbol for a connector assembly with cover

\* No need to indicate the part number for a connector assembly with cover in this case.

# TROUBLE SHOOTING

Should any trouble be found during operation, trace the source of the trouble in the following order and take correctiv

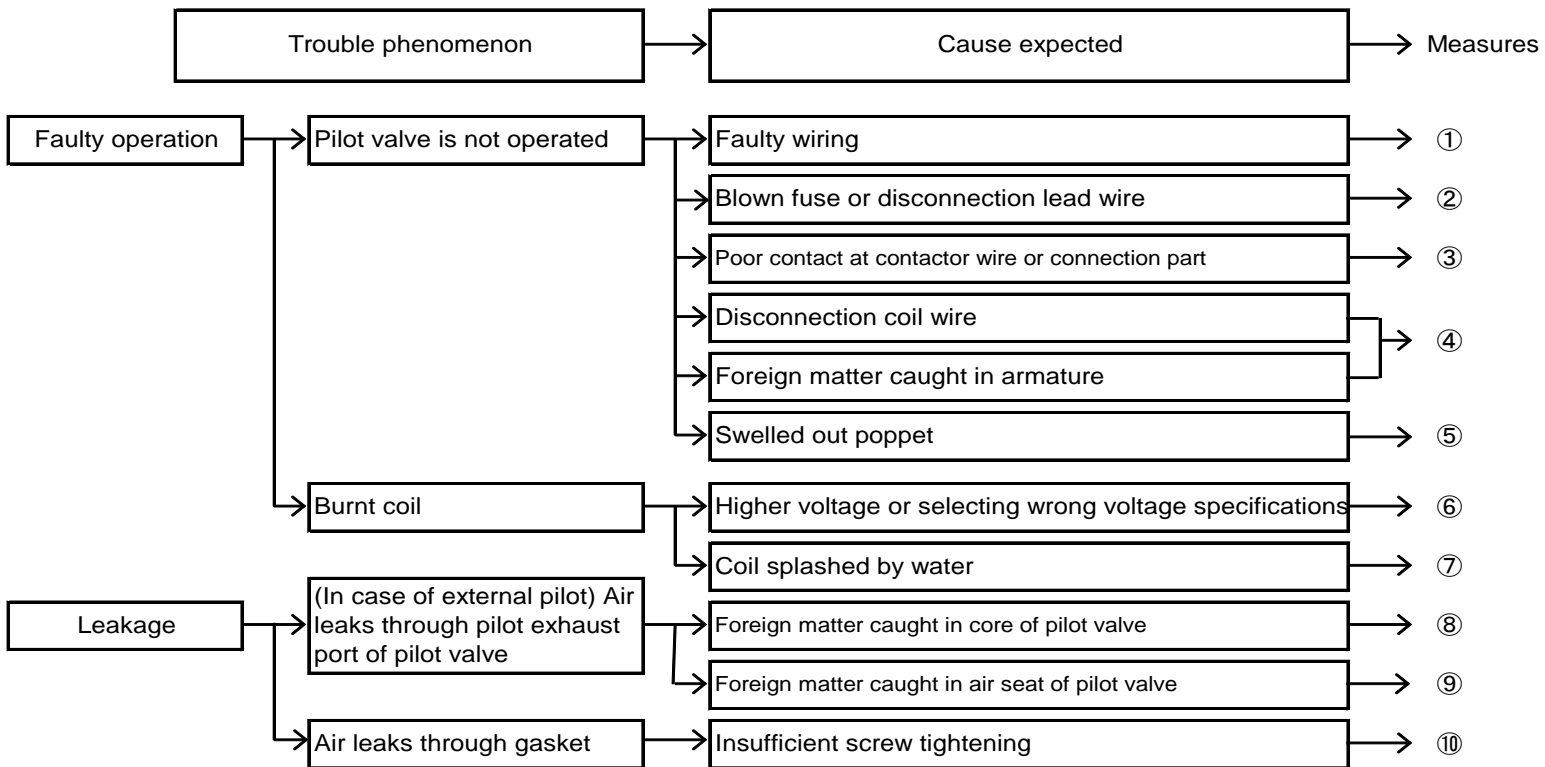

## Remedy

No.	Remedy
①	Re-wire correctly.
②	Replace part.
③	Replace part or re-wire positively.
④	Replace pilot valve ass'y
⑤	<ul style="list-style-type: none"><li>• If wrong oil is used, completely air blow to remove oil, and replace valve. After valve is replaced, use turbin oil class 1 (ISO VG32).</li><li>• In applications where excessive condensate is produced, install either an auto-drain or a dryer. The valve should be replaced.</li></ul>
⑥	Check voltage. Replace pilot valve ass'y.
⑦	Protect the valve so that water does not splash the coil. Replace pilot valve ass'y.
⑧	Replace worn spool valve. To remove foreign matter, air blow piping, then replace valve.
⑨	Replace or replace actuators.
⑩	Isolate the valve and re-tighten the bolts.

If no improvement is achieved in spite of the above countermeasure, inside of the valve may have some abnormality. In this case, stop using the valve immediately.

If any of followings are carried out, inside of the valve may have some failure. In this case, stop using the valve immediately.

- ① Voltage out of rated voltage has been used.
- ② Oil other than the specified one has been lubricated.
- ③ Lubrication has been stopped intermediately, or lubrication was suspended temporary.
- ④ Water splashed directly.
- ⑤ Strong impact was given.
- ⑥ Alien substance such as drain and particle got into. Drain or garbage invaded a valve.
- ⑦ Prohibited way of using the valve which is written at "Precautions" section in this operation manual was carried out excluding above-mentioned.

In addition, in the case of trouble, please send it back to the supplier for repair or replacement.

Revision history
------------------

1st Printing :WQ

## SMC Corporation

4-14-1, Sotokanda, Chiyoda-ku, Tokyo 101-0021 JAPAN

Tel: + 81 3 5207 8249 Fax: +81 3 5298 5362

URL <http://www.smcworld.com>

---

Note: Specifications are subject to change without prior notice and any obligation on the part of the manufacturer.

© 2017 SMC Corporation All Rights Reserved



No.V100-OMV0001