



# Operation Manual

5 Port Solenoid Valve

PRODUCT NAME

VFR3000 Series

MODEL/ Series

**SMC Corporation**

# Contents

Safety Instructions	2,3
Precautions on Design	4,5
Selection	4,5
Mounting	5
Piping	6
Wiring	6
Lubrication	6
Air Supply	6,7
Operating Environment	7
Maintenance	7
Specific Product Precautions	8 to 11
Trouble shooting	12
Remedy	13



# Safety Instructions

These safety instructions are intended to prevent hazardous situations and/or equipment damage. These instructions indicate the level of potential hazard with the labels of “Caution,” “Warning” or “Danger.” They are all important notes for safety and must be followed in addition to International Standards (ISO/IEC)\*1), and other safety regulations.

\*1) ISO 4414: Pneumatic fluid power -- General rules relating to systems  
ISO 4413: Hydraulic fluid power -- General rules relating to systems  
IEC 60204-1: Safety of machinery -- Electrical equipment of machines (Part 1: General requirements)  
ISO 10218-1992: Manipulating industrial robots -Safety.  
etc.



## Caution

**Caution** indicates a hazard with a low level of risk which, if not avoided, could result in minor or moderate injury.



## Warning

**Warning** indicates a hazard with a medium level of risk which, if not avoided, could result in death or serious injury.



## Danger

**Danger** indicates a hazard with a high level of risk which, if not avoided, will result in death or serious injury.

## Warning

### **1. The compatibility of the product is the responsibility of the person who designs the equipment or decides its specifications.**

Since the product specified here is used under various operating conditions, its compatibility with specific equipment must be decided by the person who designs the equipment or decides its specifications based on necessary analysis and test results.

The expected performance and safety assurance of the equipment will be the responsibility of the person who has determined its compatibility with the product.

This person should also continuously review all specifications of the product referring to its latest catalog information, with a view to giving due consideration to any possibility of equipment failure when configuring the equipment.

### **2. Only personnel with appropriate training should operate machinery and equipment.**

The product specified here may become unsafe if handled incorrectly.

The assembly, operation and maintenance of machines or equipment including our products must be performed by an operator who is appropriately trained and experienced.

### **3. Do not service or attempt to remove product and machinery/equipment until safety is confirmed.**

1. The inspection and maintenance of machinery/equipment should only be performed after measures to prevent falling or runaway of the driven objects have been confirmed.

2. When the product is to be removed, confirm that the safety measures as mentioned above are implemented and the power from any appropriate source is cut, and read and understand the specific product precautions of all relevant products carefully.

3. Before machinery/equipment is restarted, take measures to prevent unexpected operation and malfunction.

### **4. Contact SMC beforehand and take special consideration of safety measures if the product is to be used in any of the following conditions.**

1. Conditions and environments outside of the given specifications, or use outdoors or in a place exposed to direct sunlight.

2. Installation on equipment in conjunction with atomic energy, railways, air navigation, space, shipping, vehicles, military, medical treatment, combustion and recreation, or equipment in contact with food and beverages, emergency stop circuits, clutch and brake circuits in press applications, safety equipment or other applications unsuitable for the standard specifications described in the product catalog.

3. An application which could have negative effects on people, property, or animals requiring special safety analysis.

4. Use in an interlock circuit, which requires the provision of double interlock for possible failure by using a mechanical protective function, and periodical checks to confirm proper operation.



# Safety Instructions

## Caution

### **1. The product is provided for use in manufacturing industries.**

The product herein described is basically provided for peaceful use in manufacturing industries.

If considering using the product in other industries, consult SMC beforehand and exchange specifications or a contract if necessary.

If anything is unclear, contact your nearest sales branch.

## **Limited warranty and Disclaimer/Compliance Requirements**

The product used is subject to the following “Limited warranty and Disclaimer” and “Compliance Requirements”.

Read and accept them before using the product.

### **Limited warranty and Disclaimer**

#### **1. The warranty period of the product is 1 year in service or 1.5 years after the product is delivered.\*2)**

Also, the product may have specified durability, running distance or replacement parts. Please consult your nearest sales branch.

#### **2. For any failure or damage reported within the warranty period which is clearly our responsibility, a replacement product or necessary parts will be provided.**

This limited warranty applies only to our product independently, and not to any other damage incurred due to the failure of the product.

#### **3. Prior to using SMC products, please read and understand the warranty terms and disclaimers noted in the specified catalog for the particular products.**

#### **\*2) Vacuum pads are excluded from this 1 year warranty.**

A vacuum pad is a consumable part, so it is warranted for a year after it is delivered.

Also, even within the warranty period, the wear of a product due to the use of the vacuum pad or failure due to the deterioration of rubber material are not covered by the limited warranty.

### **Compliance Requirements**

#### **1. The use of SMC products with production equipment for the manufacture of weapons of mass destruction(WMD) or any other weapon is strictly prohibited.**

#### **2. The exports of SMC products or technology from one country to another are governed by the relevant security laws and regulation of the countries involved in the transaction. Prior to the shipment of a SMC product to another country, assure that all local rules governing that export are known and followed.**



VFR3000 Series

# 5 Port Solenoid Valve / Precautions 1

Be sure to read before handling.

## Design / Selection

### Warning

#### 1. Confirm the specifications.

Products represented in this manual are designed only for use in compressed air systems (including vacuum).

Do not operate at pressures or temperatures, etc., beyond the range of specifications, as this can cause damage or malfunction. (Refer to the specifications.)

Please contact SMC when using a fluid other than compressed air (including vacuum).

We do not guarantee against any damage if the product is used outside of the specification range.

#### 2. Actuator drive

When an actuator, such as a cylinder, is to be driven using a valve, take appropriate measures (cover installation or approach prohibition) to prevent potential danger caused by actuator operation.

#### 3. Intermediate stops

For 3 position closed center or double check valve style, it is difficult to make a piston stop at the required position accurately and precisely due to the compressibility of air. Furthermore, since valves and cylinders are not guaranteed for zero air leakage, it may not be possible to hold a stopped position for an extended period of time.

Please contact SMC if it is necessary to hold a stopped position for an extended period of time.

#### 4. Effect of back pressure when using a manifold

Use caution when valves are used on a manifold, because an actuator may malfunction due to back-pressure.

For 3-position exhaust center valve or single acting cylinder, take appropriate measures to prevent malfunction by using it with an individual EXH Spacer assembly (VVFS3000-R-03-1,2).

#### 5. Holding pressure (including vacuum)

Since the valves are subject to air leakage, they cannot be used for applications such as holding pressure (including vacuum) in a pressure vessel.

#### 6. Not suitable for use as an emergency shutoff valve, etc.

The valves listed in this manual are not designed for safety applications such as an emergency shutoff valve. If the valves are used for the mentioned applications, additional safety measures should be adopted.

#### 7. Release of residual pressure

For maintenance purposes install a system for releasing residual pressure. Especially in the case of 3-position closed center valve or double check valve type, ensure that the residual pressure between the valve and the cylinder is released.

#### 8. Double solenoid type

When using the double solenoid type for the first time, actuators may travel in an unexpected direction depending on the switching position of the valve. Implement measures to prevent any danger from occurring when operating the actuator.

#### 9. Ventilation

Provide ventilation when using a valve in a confined area, such as in a closed control panel. For example, install a ventilation opening, etc. in order to prevent pressure from increasing inside of the confined area and to release the heat generated by the valve.

#### 10. Extended periods of continuous energization

- If a valve will be continuously energized for an extended period of time, the temperature of the valve will increase due to the heat generated by the coil. This will likely adversely affect the performance of the solenoid valve and any nearby peripheral equipment. Therefore, when it is continuously energized or the energized period per day is longer than the de-energized period use a DC specification valve.
- For applications such as mounting a valve on a control panel, incorporate measure to limit the heat radiation so that it is within the operating temperature range. For example, the temperature will be high when a 3 station manifold or larger is put next to other valves and continuously energized.

#### 11. Do not disassemble the product or make any modifications, including additional machining.

It may cause human injury and/or an accident.

### Caution

#### 1. Momentary energization

If a double solenoid valve is operated with momentary energization, it should be energized for at least 0.1 second. However, depending on the condition of the secondary load, it should be energized until the cylinder reaches the stroke and position, since there is a possibility of malfunction.



## VFR3000 Series

# 5 Port Solenoid Valve / Precautions 2

Be sure to read before handling.

### Design / Selection

## ⚠ Caution

### 2. Leakage voltage

Take note that the leakage voltage will increase when a resistor is used in parallel with switching element or a C-R circuit (surge voltage suppressor) is used for protecting a switching device because of the passing leakage voltage through the C-R circuit. The suppressor residual leakage voltage should be as follows.

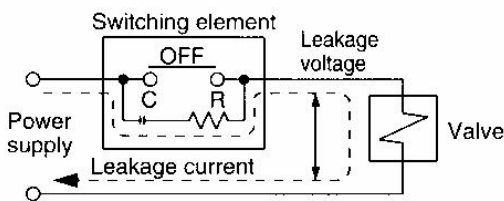

DC coil: 3% or less of rated voltage  
AC coil: 20% or less of rated voltage

### 3. Solenoid valve drive for AC with a solid state output (SSR, TRIAC output, etc.)

#### 1) Current leakage

When using a snubber circuit (C-R element) for surge protection of the output, a very small amount of electrical current will continue to flow even during the OFF state.

This results in the valve not returning. In a situation where the tolerance is exceeded, as in the above case, take measures to install a bleeder resistor.

#### 2) Minimum allowable load amount (Min. load current)

When the consumption current of a valve is less than the output's minimum allowable load volume or the margin is small, the output may not switch normally. Please contact SMC.

### 4. Surge voltage suppressor

If a surge protection circuits contains nonstandard diodes, such as Zener diodes or varistor, a residual voltage that is in proportion to the protective circuit and the rated voltage will remain. Therefore, take into consideration the surge voltage protection of the controller.

In the case of diodes, the residual voltage is approximately 1V.

### 5. Operation in a low temperature condition

It is possible to operate a valve in extreme temperature, as low as  $-10^{\circ}\text{C}$ . Take appropriate measures to avoid freezing of drainage, moisture etc. in low temperature.

### 6. Operation for air blowing

When using a solenoid valve for air blowing, use an external pilot type.

Use caution because the pressure drop caused by the air blowing can have an affect on the internal pilot type valve when the internal pilot type valves and external pilot type valves are used on the same manifold.

Additionally, when compressed air within the pressure range of the established specifications is supplied to the external pilot type valve's port, and a double solenoid valve is used for air blowing, the solenoids should normally be energized when air is being blown.

### 7. Mounting orientation

Mounting orientation is free.

### Mounting

## ⚠ Warning

### 1. Operation manual

Install the products and operate them only after reading the operation manual carefully and understanding its contents. Also, keep the manual where it can be referred to as necessary.

### 2. Ensure sufficient space for maintenance activities.

When installing the products, allow access for maintenance.

### 3. Tighten threads with the proper tightening torque.

When installing the products, follow the listed torque specifications.

### 4. If air leakage increases or equipment does not operate properly, stop operation.

Check mounting conditions when air and power supplies are connected. Initial function and leakage tests should be preformed after installation.

### 5. Painting and coating

Warnings or specifications printed or affixed to the product should not be erased, removed or covered up.

Please consult with SMC before applying paint to resinous parts, as this may have an adverse effect due to the solvent in the paint.



## VFR3000 Series

# 5 Port Solenoid Valve / Precautions 3

Be sure to read before handling.

### Piping

## ⚠ Caution

### 1. Preparation before piping

Before piping is connected, it should be thoroughly blown out with air (flushing) or washed to remove chips, cutting oil and other debris from inside the pipe.

### 2. Wrapping of pipe tape

When screwing piping or fittings into ports, ensure that chips from the pipe threads or sealing material do not enter the piping. Also, if pipe tape is used, leave 1 thread ridge exposed at the end of the threads.

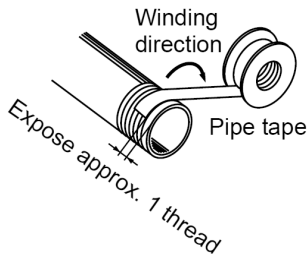

### 3. Closed center type

For closed center type, check the piping to prevent air leakage from the piping between the valve and the cylinder.

### 4. Connection of fittings

When screwing fittings into valves, tighten as follows.

#### Rc

Tighten with the proper torque shown below.

#### Tightening Torque for Piping

Connection thread	Proper tightening torque (N · m)
Rc1/8	7 to 9
Rc1/4	12 to 14
Rc3/8	22 to 24
Rc1/2	28 to 30

Follow the procedure of the manufacturer when fittings other than SMC is used.

### Wiring

## ⚠ Caution

### 1. Polarity

When connecting power to a solenoid valve with a DC specification and equipped with a light or surge voltage suppressor, check for polarity.

If polarity connection is wrong, the valve does not operate.

### 2. Applied voltage

When electric power is connected to a solenoid valve, be careful to apply the proper voltage. Improper voltage may cause malfunction or coil damage.

### 3. Check the connections.

Check if the connections are correct after completing all wiring.

### Lubrication

## ⚠ Warning

### 1. Lubrication

- The valve has been lubricated for life by the factory and does not require any further.
- If a lubricant is used in the system, use class 1 turbine oil (no additive), ISO VG32.  
Once a lubricant is used in the system, lubrication must be continued because the original lubricant applied during manufacturing will be washed away.  
If turbine oil is used, refer to the Material Safety Data Sheet (MSDS) of the oil.
- Please contact SMC regarding class 2 turbine oil (with additives), ISO VG32.

### Air Supply

## ⚠ Warning

### 1. Type of fluids

Please consult with SMC when using the product in applications other than compressed air.

### 2. When there is a large amount of drainage.

Compressed air containing a large amount of drainage can cause malfunction of pneumatic equipment. An air dryer or water separator should be installed upstream from filters.

### 3. Drain flushing

If condensation in the drain bowl is not emptied on a regular basis, the bowl will overflow and allow the condensation to enter the compressed air lines. It causes malfunction of pneumatic equipment.

If the drain bowl is difficult to check and remove, installation of a drain bowl with an auto drain option is recommended.

For compressed air quality, refer to SMC's Best Pneumatics catalog.

### 4. Use clean air.

Do not use compressed air that contains chemicals, synthetic oils including organic solvents, salt or corrosive gases, etc., as it can cause damage or malfunction.



VFR3000 Series

## 5 Port Solenoid Valve / Precautions 4

Be sure to read before handling.

### Air Supply

#### Caution

1. When extremely dry air is used as the fluid, degradation of the lubrication properties inside the equipment may occur, resulting in reduced reliability (or reduced service life) of the equipment. Please consult with SMC.

2. **Install an air filter.**

Install an air filter upstream near the valve. Select an air filter with a filtration size of 5 $\mu$ m or smaller.

3. **Take measures to ensure air quality, such as by installing an aftercooler, air dryer, or water separator.**

Compressed air that contains a large amount of drainage can cause malfunction of pneumatic equipment such as valves. Therefore, take appropriate measures to ensure air quality, such as by providing an aftercooler, air dryer, or water separator.

4. **If excessive carbon powder is seen, install a mist separator on the upstream side of the valve.**

If excessive carbon powder is generated by the compressor, it may adhere to the inside of a valve and cause it to malfunction.

For compressed air quality, refer to SMC's Best Pneumatics catalog.

### Operating Environment

#### Warning

1. Do not use in an atmosphere having corrosive gases, chemicals, sea water, water, water steam, or where there is direct contact with any of these.
2. Do not use in an environment where flammable gas or explosive gas exists. Usage may cause a fire or explosion. The products do not have an explosion proof construction.
3. Do not use in a place subject to heavy vibration and/or shock.
4. The valve should not be exposed to prolonged sunlight. Use a protective cover.
5. Remove any sources of excessive heat.

6. If it is used in an environment where there is possible contact with oil, weld spatter, etc., exercise preventive measures.
7. When the solenoid valve is mounted in a control panel or its energized for a long time, make sure ambient temperatures is within the specification of the valve.

### Maintenance

#### Warning

1. **Perform maintenance inspection according to the procedures indicated in the operation manual.**

If handled improperly, malfunction and damage of machinery or equipment may occur.

2. **Removal of equipment, and supply/exhaust of compressed air**

When components are removed, first confirm that measures are in place to prevent workpieces from dropping, run-away equipment, etc. Then, cut off the supply pressure and electric power, and exhaust all compressed air from the system using the residual pressure release function.

For 3-position closed center type, exhaust the residual pressure between the valve and the cylinder.

When the equipment is operated after remounting or replacement, first confirm that measures are in place to prevent lurching of actuators, etc. Then, confirm that the equipment is operating normally.

3. **Low frequency operation**

Valves should be operated at least once every 30 days to prevent malfunction. (Use caution regarding the air supply.)

4. **Manual override**

When the manual override is operated, equipment will be actuated.

Operate after safety is confirmed.

#### Caution

1. **Drain flushing**

Remove drainage from the air filters regularly.

2. **Lubrication**

In the case of rubber seals, once lubrication has been started, it must be continued.

Use class 1 turbine oil (with no additive), ISO VG32 because if other lubricant oil is used, it may cause malfunction. Please contact SMC for suggested class 2 turbine oil (with additive), ISO VG32.





## VFR3000 Series

# 5 Port Solenoid Valve / Specific Product 1

Be sure to read before handling.

### Lead Wire Connection

## Caution

### Plug-in type (With terminal block)

- If you remove the junction cover (1) on the sub-plate, you will see the plug-in terminal block (2) attached to the inside of sub-plate.

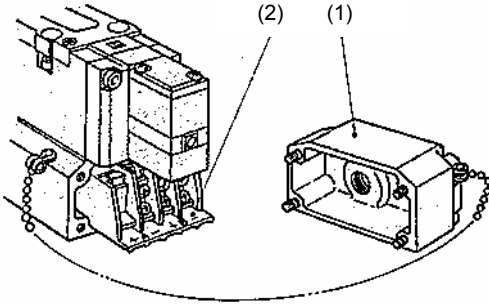

- The following marking are on the terminal block. Connect with corresponding power side.

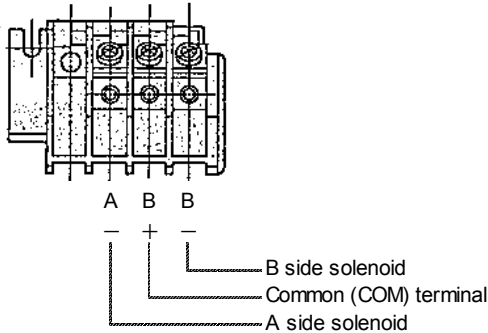

- Although "A-", "B+" and "B-" marks are indicated on the terminal block, this can be used as either "+COM" or "-COM".
- Applicable terminal:  
1.25-3, 1.25-3S, 1.25Y-3N, 1.25Y-3S

### Non plug-in type

- Type G: Lead wire comes directly from the solenoid part. Connect it with the power source. Grommet with DC voltage surge voltage suppressor has polarity. Connect red lead wire to + (positive) side and black to - (negative) side.

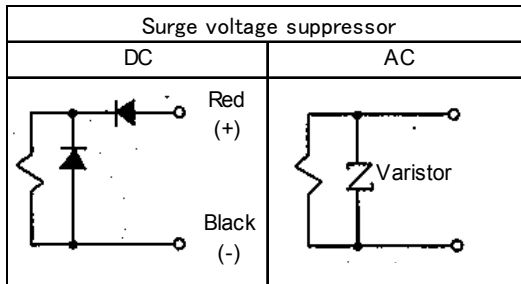

- Type E, T, D, Y: In the case of DIN terminal block and terminal block, there is no polarity of positive [+] and negative [-]. Connect no.1 and no.2 terminals with corresponding power side.

With DIN terminal block

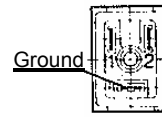

With terminal block

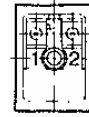

- Applicable cable O.D.  
Type T:  $\phi 6$  to  $\phi 8$  mm  
Type E:  $\phi 2.3$  to  $\phi 2.8$  mm  
Type D, Y:  $\phi 4.5$  to  $\phi 7$  mm
- Applicable crimp terminal  
Type E, T: 1.25-3, 1.25-3S, 1.25Y-3N, 1.25Y-3S (Round shape or Y shape crimp terminal cannot be used for Type D.)

### DIN terminal block type

- Male pin terminal of DIN terminal block of solenoid valves are wired as shown below. Connect to corresponding terminal on the connector.

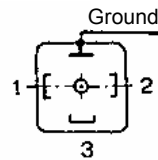

Terminal No.	Internal wiring
1	Sol. A side
2	Sol. B side
3	COM
⏏	Ground

- Can be used as either "+COM", "-COM"
- Applicable cable  
Cross section of the wire: 0.5 to 1.5mm<sup>2</sup>  
Cable O.D.:  $\phi 8$  to  $\phi 10$ mm
- Applicable terminal  
Corresponding to R1.25-3 of JIS C 2805, J.S.T Co., Ltd. Equivalent to R1.25-3
- Proper tightening torque of the connector  
Connector set screw 0.5 to 0.6 N·m  
Terminal screw 0.5 to 0.6 N·m
- Incorrect connection of "COM terminal" (DIN terminal no.3) can cause damage on power source circuit.

### Terminal block type

- Remove cover (1), over terminal block (2) attached to the inside of body. Connect with corresponding power side. For a style with light and surge voltage suppressor, straightly pull out the light and surge voltage suppressor substrate (3) and then connect them.

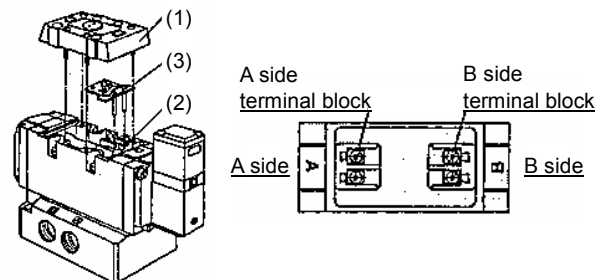

- Applicable terminal:  
1.25-3, 1.25-3S, 1.25Y-3N, 1.25Y-3S



## VFR3000 Series

# 5 Port Solenoid Valve / Specific Product 2

Be sure to read before handling.

### Light/Surge Voltage Suppressor

#### Plug-in type (VFR3□00)

Light/Surge  
voltage  
suppressor

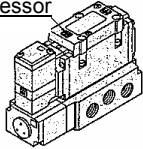

#### Non plug-in type

(VFR3□10) (VFR3□40)

Light/Surge  
voltage  
suppressor

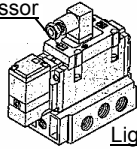

Light/Surge  
voltage  
suppressor

(VFR3□00, VFR3□10)

Voltage		Light/Surge voltage suppressor
AC	Single solenoid	
	Double solenoid	
24VDC or less	Single solenoid	
	Double solenoid	

(VFR3□40)

Voltage	Light/Surge voltage suppressor
AC and 100VDC	
24 VDC or less	

Light/Surge voltage suppressor is not available for grommet type.

### Used as a 3 Port Valve

Plugging one of the cylinder ports (A or B) enables use as a normally closed (N.C.) or normally open (N.O.) 3 port valve.

It is convenient when 3 port valve is needed on a manifold, etc., but it can't be used in special applications such as using as a non-leakage valve. Use it with the exhaust port leaving open.

Plug	B port	A port
Type of actuation	N.C.	N.O.
Number of solenoids	Single 	Single 
	Double 	Double 

### How to Exchange Solenoid Valve, Pilot Valve Assembly

#### How to exchange solenoid valve

Loosen set screw and take solenoid valve out vertically, otherwise it may cause damage to the solenoid valve. Never remove valve at an angle.

When mounting solenoid valve on to the base, plug pin assembly (base-side) into receptacle assembly (body-side) vertically.

Solenoid valve

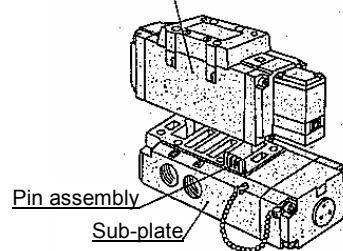

Tightening Torque for  
Mounting Bolt: 1.1 N·m

#### How to exchange pilot valve assembly

Possible to exchange pilot valve assembly like the following figure.

Note) Do not change the rated voltage.

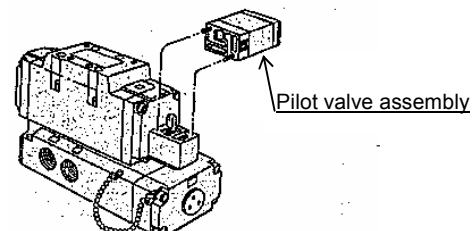



## VFR3000 Series

# 5 Port Solenoid Valve / Specific Product 3

Be sure to read before handling.

### Change Direction of DIN Connector/Cable Entry

Unscrew retaining screw, pull off outer cover, rotate connector block through 180°. Replace cover and tighten screw.

### Interface Regulator

## Caution

### Specifications

Interface regulator		ARBF3050		
Regulating port		A	B	P
Maximum operating pressure		1.0 MPa <sup>(1)</sup>		
Set pressure range		0.1 to 0.83 MPa <sup>(2)</sup>		
Ambient and fluid temperature		-5 to 60°C (No freezing) <sup>(3)</sup>		
Port size for connection of pressure gauge		Rc 1/8		
Weight (kg)		0.46		
Effective area at supply side (mm <sup>2</sup> ) S at P <sub>1</sub> =0.7 MPa/P <sub>2</sub> =0.5 MPa	P→A	21	18.5	11
	P→B	18.5	22	12
Effective area at exhaust side (mm <sup>2</sup> ) S at P <sub>2</sub> =0.5 MPa	A→EA	40		
	B→EB	36		

Note 1) Maximum operating pressure of solenoid valve is 0.9 MPa.

Note 2) Set the pressure within operating pressure range of solenoid valve.

Note 3) Solenoid valve: Max. 50°C.

Note 4) Synthesized effective area with 2 position.

Note 5) - Operate an interface regulator only by applying pressure from the "P" port of the base, except when using it as a reverse pressure valve.

- To combine a pressure center valve and the A and B port pressure reduction interface regulator, use the ARBF3000 model.
- To combine a reverse pressure valve and an interface regulator, use the ARBF3000 model. The P port pressure reduction cannot be used.
- When combining a double check valve and an interface regulator, use a manifold or sub-plate as a basis, and stack them in the following order; the perfect spacer → the interface regulator → the valve.
- When a closed center valve is combined with the interface regulator's A, B port regulation, note that it cannot be used for intermediate stops of a cylinder because there is leakage from relief port on the regulator.

### Lead Wire Connection

## Caution

### Type 01T with Terminal Block

- Remove junction cover of manifold, exposing terminal block attached to the manifold block. Lead wires from solenoid valve are connected with the terminals on upper side of terminal block. (On the terminal block, lead wire is connected with both A and B sides of solenoid valve in accordance with the corresponding markings A and B on the block.) Connect each lead wire of power side corresponding to respective solenoid valve on the lower terminal block. Terminal block wiring specifications is in accordance with COM.

Terminal block marking Model	A -	B +	B -
VFR3100	A side	COM	
VFR3200	A side	COM	B side
<sup>3</sup> VFR3400 <sup>5</sup>	A side	COM	B side

- Applicable terminal  
1.25-3.5M, 1.25Y-3L, 1.25-3M
- Although "A-", "COM+" and "B-" marks are indicated on the terminal block, VFR3000 can be used as either "+COM" or "-COM".



## VFR3000 Series

# 5 Port Solenoid Valve / Specific Product 4

Be sure to read before handling.

### Lead Wire Connection

## Caution

### Type 01C Circular Connector

- Wire connection specification

Lead wire for both of solenoid A and B sides in manifold are connected to connector terminal as COM specifications.

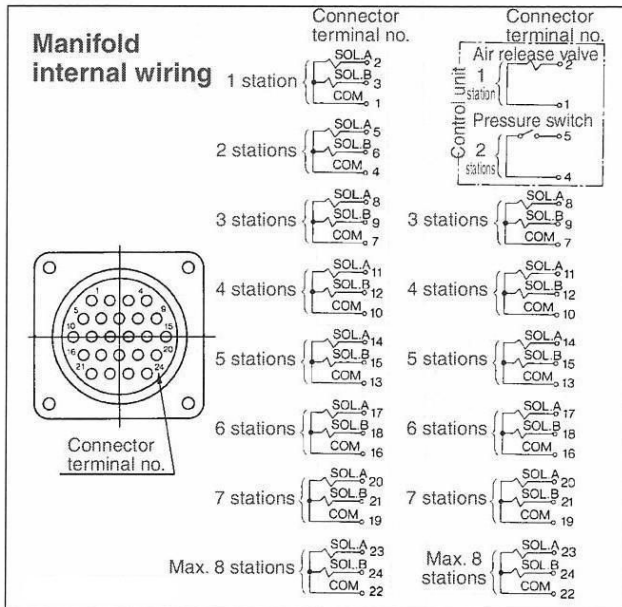
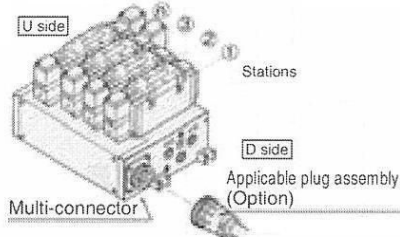

Note 1) Maximum number is 8 stations.

Note 2) It is used as +COM and -COM.

Note 3) Station numbers are started from D side although connector is mounted on D or U Side.

### Type 01F D-sub Connector

- Wire connection specification

Lead wire for both of solenoid A and B sides in manifold are connected to connector terminal as COM specifications.

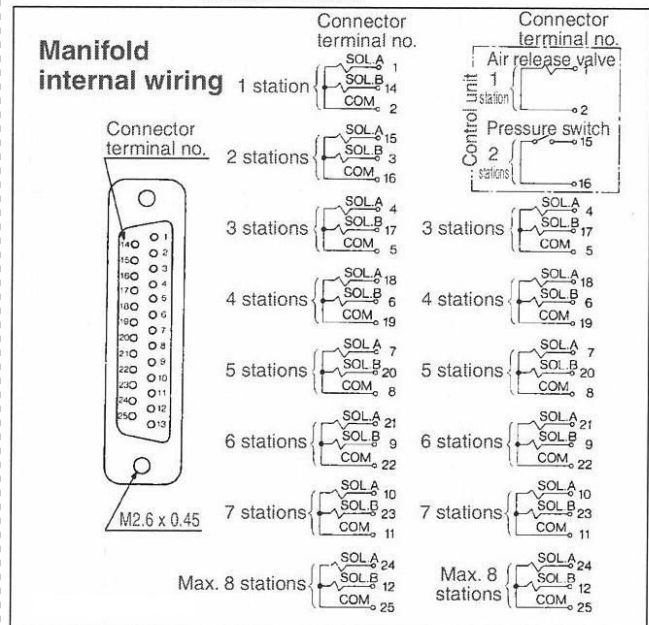
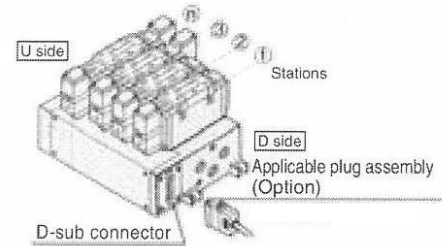

Note 1) Maximum number is 8 stations.

Note 2) It is used as +COM and -COM.

Note 3) Station numbers are started from D side although connector is mounted on D or U Side.

**TROUBLE SHOOTING**

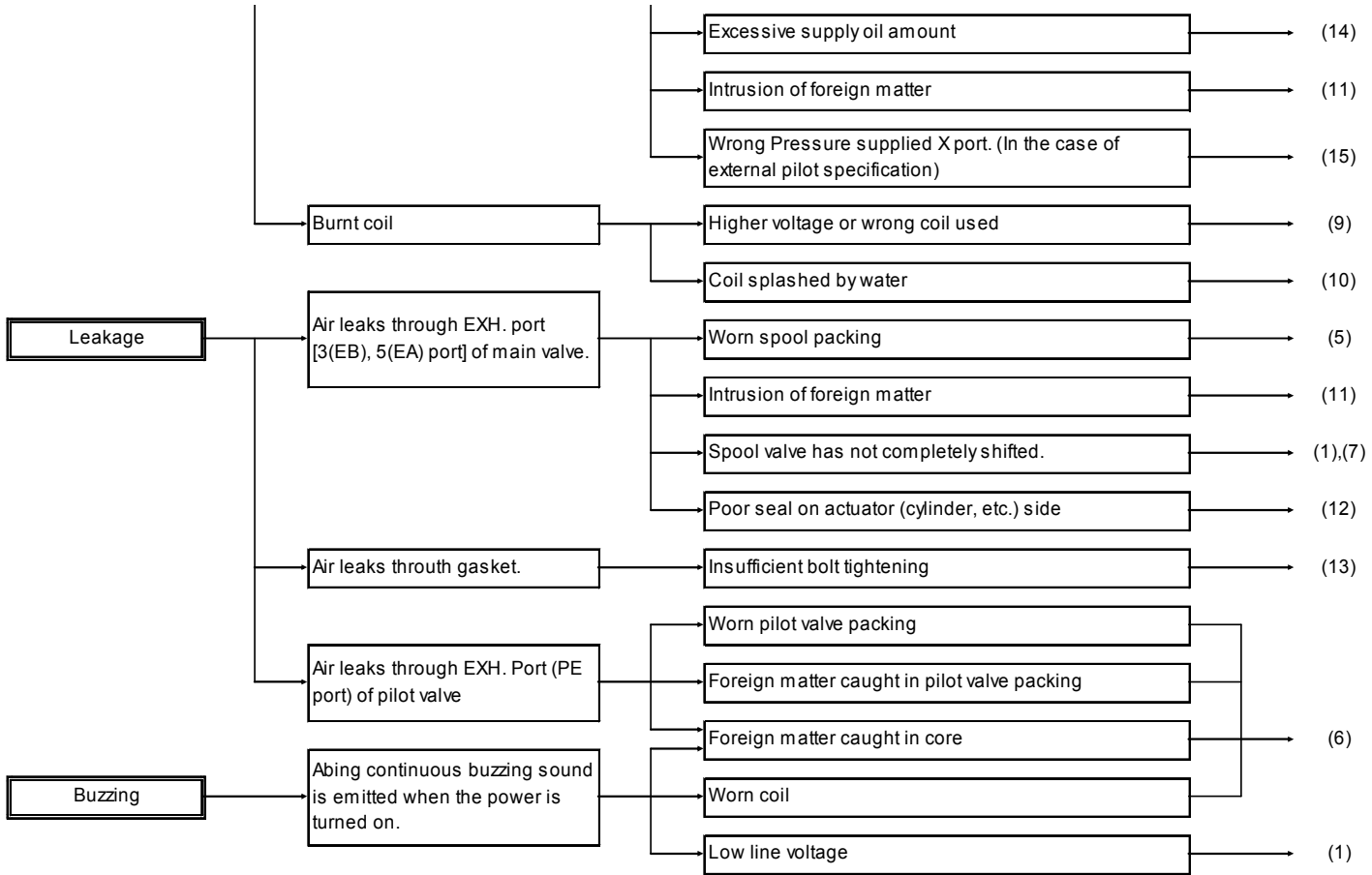

## REMEDY

No.	Remedy
(1)	Regulate voltage, so that the voltage at the time of the operation becomes specifications range.
(2)	Re-wire correctly.
(3)	Replace part.
(4)	Replace part or re-wire positively.
(5)	Replace valve.
(6)	Replace pilot valve assembly.
(7)	Adjust pressure so that pilot pressure will fall within operating pressure range during operation.
(8)	-If wrong oil used, completely air blow to remove oil and replace valve. After valve is replaced, use turbine oil class 1 (ISO VG32). -When a large quantity of drain is given and cannot carry out drain omission surely, install either an auto-drain or a dryer. The valve should be replaced.
(9)	Check voltage. Replace pilot valve assembly.
(10)	Protect the valve so that water does not splash the coil. Replace pilot valve assembly.
(11)	To remove foreign matter, clean the pipe by air blow. Replace valve.
(12)	Repair or replace actuators.
(13)	Isolate the valve and re-tighten the bolts.
(14)	Lessen the oil supply amount to the degree that oil does not spout out of the exhaust port [3(EB), 5(EA), PE port]. *In the case of N.O. specification, 1(P) port.
(15)	Supply specified pressure to X port. (Single solenoid, 3 position: 0.2 to 0.9 MPa, Double solenoid: 0.1 to 0.9 MPa)

If no improvement is achieved in spite of the above countermeasure, inside of the valve may have some abnormality. In this case, stop using the valve immediately

If any of followings are carried out, inside of the valve may have some failure. In this case, stop using the valve immediately

1. Voltage out of rated voltage has been used.
2. Oil other than specified one has been lubricated.
3. Lubrication has been stopped intermediately, or lubrication was suspended temporary.
4. Water splashed directly.
5. Strong impact was given.
6. Alien substance such as drain and particle got into. Drain or garbage invaded a valve.
7. Prohibited way of using the valve which is written at "Precautions" section in this operation manual was carried out excluding above -mentioned.

In addition, in the case of trouble, please send it back to the supplier for repair or replacement.

Revision history		
<b>A</b>	Renewal	KQ
<b>B</b>	Renewal	PP

1st printing: HT

# SMC Corporation

4-14-1, Sotokanda, Chiyoda-ku, Tokyo 101-0021 JAPAN

Tel: + 81 3 5207 8249 Fax: +81 3 5298 5362

URL <http://www.smcworld.com>

---

Note: Specifications are subject to change without prior notice and any obligation on the part of the manufacturer.

© 2008 SMC Corporation All Rights Reserved