



# Operation Manual

Process valve

PRODUCT NAME

VNB Series

MODEL / Series / Product Number

**SMC Corporation**

# Contents

Safety Instructions .....	2,3
Design .....	4
Selection .....	4
Mounting .....	4
Piping .....	4,5
Operating Environment .....	5
Maintenance .....	5
Operating Precautions .....	5
How to use DIN connector .....	6
Indicator Light/Surge Voltage Suppressor .....	6
Electrical Connections .....	6
Specific Product Precautions .....	7
Troubleshooting .....	8,9



# Safety Instructions

These safety instructions are intended to prevent hazardous situations and/or equipment damage. These instructions indicate the level of potential hazard with the labels of "Caution," "Warning" or "Danger." They are all important notes for safety and must be followed in addition to International Standards (ISO/IEC)<sup>\*1)</sup>, and other safety regulations.

\*1) ISO 4414: Pneumatic fluid power -- General rules relating to systems.

ISO 4413: Hydraulic fluid power -- General rules relating to systems.

IEC 60204-1: Safety of machinery -- Electrical equipment of machines .(Part 1: General requirements)

ISO 10218-1992: Manipulating industrial robots -Safety.

etc.



## Caution

**Caution** indicates a hazard with a low level of risk which, if not avoided, could result in minor or moderate injury.



## Warning

**Warning** indicates a hazard with a medium level of risk which, if not avoided, could result in death or serious injury.



## Danger

**Danger** indicates a hazard with a high level of risk which, if not avoided, will result in death or serious injury.

## Warning

### **1. The compatibility of the product is the responsibility of the person who designs the equipment or decides its specifications.**

Since the product specified here is used under various operating conditions, its compatibility with specific equipment must be decided by the person who designs the equipment or decides its specifications based on necessary analysis and test results.

The expected performance and safety assurance of the equipment will be the responsibility of the person who has determined its compatibility with the product.

This person should also continuously review all specifications of the product referring to its latest catalog information, with a view to giving due consideration to any possibility of equipment failure when configuring the equipment.

### **2. Only personnel with appropriate training should operate machinery and equipment.**

The product specified here may become unsafe if handled incorrectly.

The assembly, operation and maintenance of machines or equipment including our products must be performed by an operator who is appropriately trained and experienced.

### **3. Do not service or attempt to remove product and machinery/equipment until safety is confirmed.**

1. The inspection and maintenance of machinery/equipment should only be performed after measures to prevent falling or runaway of the driven objects have been confirmed.

2. When the product is to be removed, confirm that the safety measures as mentioned above are implemented and the power from any appropriate source is cut, and read and understand the specific product precautions of all relevant products carefully.

3. Before machinery/equipment is restarted, take measures to prevent unexpected operation and malfunction.

### **4. Contact SMC beforehand and take special consideration of safety measures if the product is to be used in any of the following conditions.**

1. Conditions and environments outside of the given specifications, or use outdoors or in a place exposed to direct sunlight.

2. Installation on equipment in conjunction with atomic energy, railways, air navigation, space, shipping, vehicles, military, medical treatment, combustion and recreation, or equipment in contact with food and beverages, emergency stop circuits, clutch and brake circuits in press applications, safety equipment or other applications unsuitable for the standard specifications described in the product catalog.

3. An application which could have negative effects on people, property, or animals requiring special safety analysis.

4. Use in an interlock circuit, which requires the provision of double interlock for possible failure by using a mechanical protective function, and periodical checks to confirm proper operation.



# Safety Instructions

## Caution

### **1. The product is provided for use in manufacturing industries.**

The product herein described is basically provided for peaceful use in manufacturing industries. If considering using the product in other industries, consult SMC beforehand and exchange specifications or a contract if necessary.  
If anything is unclear, contact your nearest sales branch.

## **Limited warranty and Disclaimer/Compliance Requirements**

The product used is subject to the following “Limited warranty and Disclaimer” and “Compliance Requirements”.

Read and accept them before using the product.

### **Limited warranty and Disclaimer**

#### **1. The warranty period of the product is 1 year in service or 1.5 years after the product is delivered, whichever is first.\*2)**

Also, the product may have specified durability, running distance or replacement parts. Please consult your nearest sales branch.

#### **2. For any failure or damage reported within the warranty period which is clearly our responsibility, a replacement product or necessary parts will be provided.**

This limited warranty applies only to our product independently, and not to any other damage incurred due to the failure of the product.

#### **3. Prior to using SMC products, please read and understand the warranty terms and disclaimers noted in the specified catalog for the particular products.**

#### **\*2) Vacuum pads are excluded from this 1 year warranty.**

A vacuum pad is a consumable part, so it is warranted for a year after it is delivered. Also, even within the warranty period, the wear of a product due to the use of the vacuum pad or failure due to the deterioration of rubber material are not covered by the limited warranty.

### **Compliance Requirements**

#### **1. The use of SMC products with production equipment for the manufacture of weapons of mass destruction (WMD) or any other weapon is strictly prohibited.**

#### **2. The exports of SMC products or technology from one country to another are governed by the relevant security laws and regulations of the countries involved in the transaction. Prior to the shipment of a SMC product to another country, assure that all local rules governing that export are known and followed.**



# Valves for Fluid Control Precautions 1

Be sure to read before handling.

## Design

### Warning

#### 1. Cannot be used as an emergency shutoff valve, etc.

The valves presented in this catalog are not designed for safety applications such as an emergency shutoff valve. If the valves are used in this type of system, other reliable safety assurance measures should also be adopted.

#### 2. This solenoid valve cannot be used for explosion proof applications.

#### 3. Ensure sufficient space for maintenance activities.

When installing the products, allow access for maintenance.

#### 4. Actuator drive

When an actuator, such as a cylinder, is to be driven using a valve, take appropriate measures to prevent potential danger caused by actuator operation.

#### 5. Pressure (including vacuum) holding

It is not usable for an application such as holding the pressure (including vacuum) inside of a pressure vessel because air leakage is entailed in a valve.

#### 6. When the conduit type is used as equivalent to an IP65 enclosure, install a wiring conduit, etc.

## Selection

### Warning

#### 1. Confirm the specifications.

Give careful consideration to the operating conditions such as the application, fluid and environment, and use within the specified operating ranges in this catalog.

#### 2. Fluid

##### 1) Type of fluid

Before using a fluid, confirm whether it is compatible with the materials from each model by referring to the fluids listed in this catalog. Use a fluid with a dynamic viscosity of 50 mm<sup>2</sup>/s or less. If there is something you do not know, please contact us.

##### 2) Corrosive gas

Cannot be used since it will lead to cracks by stress corrosion or result in other incidents.

##### 3) Applicable fluid on the list may not be used depending on the operating condition. Give adequate confirmation, and then determine a model, just because the compatibility list shows the general case.

#### 3. Fluid quality

The use of a fluid that contains foreign matter can cause problems such as malfunction and seal failure due to the foreign matter getting stuck to the sliding parts and valve seat. Install a suitable filter (strainer) immediately upstream from the valve.

#### 4. Air quality

##### 1) Use clean air.

Do not use compressed air that contains chemicals, synthetic oils including organic solvents, salt or corrosive gases, etc., as it can cause damage or malfunction.

##### 2) Install air filters.

Install air filters close to valves at their upstream side. A filtration degree of 5 μm or less should be selected.

##### 3) Install an aftercooler or air dryer, etc.

Compressed air that contains excessive drainage may cause malfunction of valves and other pneumatic equipment. To prevent this, install an aftercooler or air dryer, etc.

##### 4) If excessive carbon powder is generated, eliminate it by installing mist separators at the upstream side of valves.

If excessive carbon powder is generated by the compressor, it may adhere to the inside of the valves and cause a malfunction.

Refer to Best Pneumatics No.5 for further details on compressed air quality.

#### 5. Ambient environment

Use within the operable ambient temperature range. Confirm the compatibility between the product's composition materials and the ambient atmosphere. Be certain that the fluid used does not touch the external surface of the product.

#### 6. Countermeasures against static electricity

Take measures to prevent static electricity since some fluids can cause static electricity.

#### 7. Low temperature operation

1) The valve can be used in an ambient temperature of not less than -5°C. However, take measures to prevent freezing or solidification of drainage or impurities, etc.

2) When using valves for water application in cold climates, take appropriate countermeasures to prevent the water from freezing in tubing after cutting the water supply from the pump, by draining the water, etc. When warming by a heater, etc., be careful not to expose the coil portion to a heater. Installation of a dryer, heat retaining of the body is recommended to prevent a freezing condition in which the dew point temperature is high and the ambient temperature is low, and the high flow runs.

## Mounting

### Warning

#### 1. If air leakage increases or equipment does not operate properly, stop operation.

After mounting is completed, confirm that it has been done correctly by performing a suitable function test.

#### 2. Do not apply external force to the coil section.

When tightening is performed, apply a wrench or other tool to the outside of the piping connection parts.

#### 3. Mount a valve with its coil position upwards, not downwards.

#### 4. Do not warm the coil assembly with a heat insulator, etc.

Use tape, heaters, etc., for freeze prevention on the piping and body only. They can cause the coil to burn out.

#### 5. Secure with brackets, except in the case of steel piping and copper fittings.

#### 6. Avoid sources of vibration, or adjust the arm from the body to the minimum length so that resonance will not occur.

#### 7. Painting and coating

Warnings or specifications printed or labeled on the product should not be erased, removed or covered up.



# Valves for Fluid Control Precautions 2

Be sure to read before handling.

## Piping

### ⚠ Caution

1. Refer to the Fittings and Tubing Precautions for handling one-touch fittings.

#### 2. Preparation before piping

Before piping is connected, it should be thoroughly blow out with air (flushing) or washed to remove chips, cutting oil and other debris from inside the pipe.

Install piping so that it does not apply pulling, pressing, bending or other forces on the valve body.

#### 3. Wrapping of pipe tape

When connecting pipes, fittings, etc., be sure that chips from the pipe threads and sealing material do not enter the valve.

Furthermore, when pipe tape is used, leave 1.5 to 2 thread ridges exposed at the end of the threads.

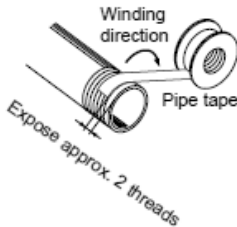

4. Avoid connecting ground lines to piping, as this may cause electric corrosion of the system.

#### 5. Tighten threads with the proper tightening torque.

When attaching fittings to valves, tighten with the proper tightening torque shown below.

#### Tightening Torque for Piping

Connection thread	Proper tightening torque (N·m)
Rc1/8	7 to 9
Rc1/4	12 to 14
Rc3/8	22 to 24
Rc1/2	28 to 30
Rc3/4	28 to 30
Rc1	36 to 38
Rc1 1/4	40 to 42
Rc1 1/2	48 to 50
Rc2	48 to 50

#### 6. Connection of piping to products

When connecting piping to a product, refer to its instruction manual to avoid mistakes regarding the supply port, etc.

7. Steam generated in a boiler contains a large amount of drainage. Be sure to operate it with a drain trap installed.

## Operating Environment

### ⚠ Warning

1. Do not use in an atmosphere having corrosive gases, chemicals, sea water, water, water steam, or where there is direct contact with any of these.
2. Do not use in explosive atmospheres.

3. Do not use in locations subject to vibration or impact.
4. Do not use in locations where radiated heat will be received from nearby heat sources.
5. Employ suitable protective measures in locations where there is contact with water droplets, oil or welding spatter, etc.

## Maintenance

### ⚠ Warning

#### 1. Removing the product

The valve will reach a high temperature when used with high temperature fluids. Confirm that the valve temperature has dropped sufficiently before performing work. If touched inadvertently, there is a danger of being burned.

- 1) Shut off the fluid supply and release the fluid pressure in the system.
- 2) Shut off the power supply.
- 3) Dismount the product.

#### 2. Low frequency operation

Switch valves at least once every 30 days to prevent malfunction.

Also, in order to use it under the optimum state, conduct a regular inspection once a half year.

### ⚠ Caution

#### 1. Filters and strainers

- 1) Be careful regarding clogging of filters and strainers.
- 2) Replace filter elements after one year of use, or earlier if the pressure drop reaches 0.1 MPa.
- 3) Clean strainers when the pressure drop reaches 0.1 MPa.

#### 2. Lubrication

When using after lubricating, never forget to lubricate continuously.

#### 3. Storage

In case of long term storage after use with heated water, thoroughly remove all moisture to prevent rust and deterioration of rubber materials, etc.

#### 4. Exhaust the drainage from an air filter periodically.

## Operating Precautions

### ⚠ Warning

1. Valves will reach high temperatures from high temperature fluids. Use caution, as there is a danger of being burned if a valve is touched directly.
2. For pilot type 2-port solenoid valves, when the valve is closed, sudden pressure resulting from the startup of the fluid supply source (pump, compressor, etc.) may cause the momentary valve to open and leakage to occur, so please exercise caution.



# Valves for Fluid Control Precautions 3

Be sure to read before handling.

## How to use DIN connector

### Disassembly

- Loosen screw (1) and pull up housing (2) in the direction of screw (1) to remove the connector from the body (solenoid).
- Pull out screw (1) from housing (2).
- On the bottom part of terminal block (3), there is a notch (9). If a small flat head screwdriver is inserted into the gap between housing (2) and terminal block (3), terminal block (3) will be removed from housing (2). (See diagram at the top right of the page.)
- Remove cable gland (4), washer (5) rubber seal (6).

### Wiring

- Insert cable gland (4), washer (5) and rubber seal (6) into cable (7) in order, and insert it into housing (2).
- Loosen screws (11) on terminal (3). Insert lead wires (10) and tighten screws (11) again.
  - Note 1) The tightening torque should be 0.5 N·m +/- 15%.
  - Note 2) The applicable outside diameter of cable (7) is  $\phi 6$  to 8 mm.
  - Note 3) Round or Y-shaped crimped terminal cannot be used.

### Assembly

- Insert cable gland (4), washer (5) and rubber seal (6) and housing (2) into cable (7) in order. Connect cable (7) to terminal block (3) and fix terminal block (3) to housing (2) in place. (Push it down until you hear the click sound.)
- Insert rubber seal (6) and washer (5) into the cable entry on housing (2) in order, and tighten cable gland (4) securely.
- Insert gasket (8) into the gap between the bottom of terminal box (3) and plug on the equipment, and insert screw (1) from the top of housing (2) to tighten them.
  - Note 1) The tightening torque should be 0.5 N·m +/- 20%.
  - Note 2) The orientation of the connector can be changed by 180 degrees depending on the mounting direction of housing (2) and terminal box (3).

## Connector for DIN Terminal

Description	Part no.
DIN connector	B1B09-2A (Standard)
	GM209NJ-B17 (CE-compliant)

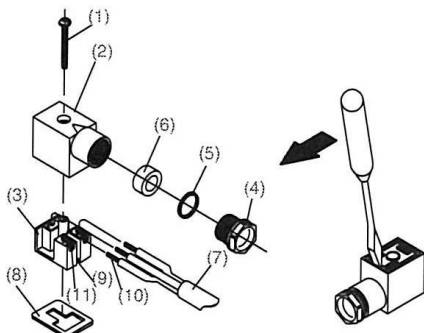

## Indicator Light/Surge Voltage Suppressor

### Caution

VNB1 to 4 (Valve size 1 to 4)  
Vacuum pilot type is excluded

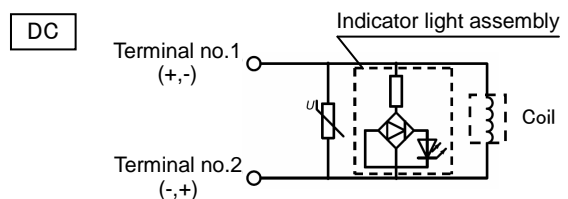
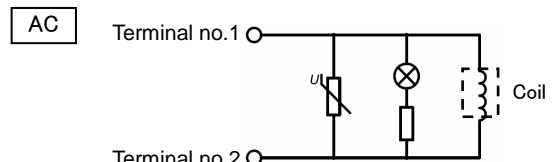

VNB5 to 7 (Valve size 5 to 7)  
Vacuum pilot type (Valve size 2 to 7)

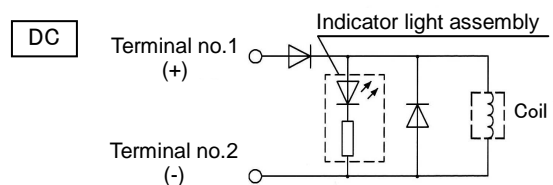
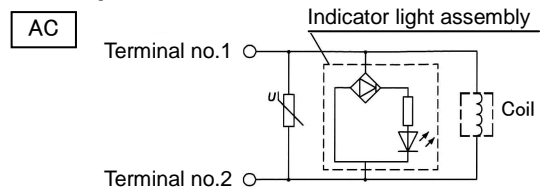

## Electrical Connection

### Caution

The DIN connector terminal and conduit terminal (with indicator light/surge voltage suppressor) are wired internally as shown below. Connect each of the wire to the corresponding wire of the power supply.

DIN terminal block

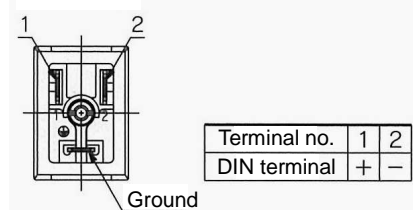

- Applicable cord outside diameter  
D type:  $\phi 6$  to 8 mm

### Lead wire colour

Voltage specification	Colour
100 VAC	Blue
200 VAC	Red
DC polar indication	Red (+), black (-)
Others	Gray



## VNB Series

# Specific Product Precautions

Be sure to read before handling.

### Design

#### Warning

##### 1. Extended periods of continuous energization

If a valve is continuously energized for long periods, heat generation of the coil may result in reduced performance and shorter service life. This may also have an adverse effect on the peripheral equipment in proximity. Should a valve be continuously energized for long periods, or its daily energized state exceeds its non energized state, please use an energy saving type AC, energizing for long periods of time continuously, select the air-operated valve and use the continuous duty type of the VT307 for a pilot valve.

### Quality of Operating Fluid

#### Warning

If the fluid which contains foreign matter is used, the foreign matters adhere to the rod sliding surface, causing operation failure and sealing failure. The sealing failure of the rod sliding surface causes the backflow of the fluid in the pilot air piping, entering the equipment of the circuit which is connected to the pilot air. This will give the equipment adverse effect. Periodic maintenance is necessary.

### Mounting

#### Warning

- Do not apply external force to the coil section.**  
When tightening is performed, apply a wrench or other tool to the outside of the piping connection parts.
- Do not warm the coil assembly with a heat insulator, etc.**  
Use tape, heaters, etc., for freeze prevention on the piping and body only. They can cause the coil to burn out.
- Avoid sources of vibration, or adjust the arm from the body to the minimum length so that resonance will not occur.**

### Piping

#### Caution

When high temperature fluids are used, use fittings and tubing with heat resistant features.  
(Self-align fittings, fluoropolymer tubing, Copper tubing, etc.)

### Wiring

#### Caution

- Applied voltage**  
When electric power is connected to a solenoid valve, be careful to apply the proper voltage. Improper voltage may cause malfunction or coil damage.
- Confirm the connections.**  
After completing the wiring, confirm that the connections are correct.

### External Pilot

#### Caution

##### Pilot port piping

12(P1) and 10(P2) piping should be as follows according to the model

##### Standard

Port	VNB□0□□	VNB□02□	VNB□03□	VNB□1□□
12 (P1)	External pilot	Bleed port	External pilot *	External pilot
10 (P2)	Bleed port	External pilot	External pilot *	Pilot exhaust

(\*) If the pilot air is not supplied, the valve position will not be held. Pressurize Port 12 (P1) or Port 10 (P2) when using the product.

##### Vacuum pilot

Port	VNB□01□V	VNB□02□V	VNB□1□□V
12 (P1)	Bleed port	External pilot	External pilot
10 (P2)	External pilot	Bleed port	Pilot exhaust

Installing a silencer to the exhaust port and the bleed port is recommended for noise reduction and for dust entry prevention.

### Mounting Direction of Pilot Solenoid Valve

#### Warning

With external pilot solenoids, the pilot solenoid valves are not splash proof specifications, and so care must be taken not to get fluid on oneself such as when performing maintenance.

#### Caution

##### Direction of mounting

When replacing a valve, if an external pilot solenoid valve is mounted in the wrong direction, it may malfunction or leak air.

### Vacuum Pilot

#### Caution

When using the VNB□□ 1□V N.C. vacuum pilot, maintain the specified pilot pressure by providing a tank with an appropriate capacity or by acquiring the pilot pressure from an area near the vacuum pump.

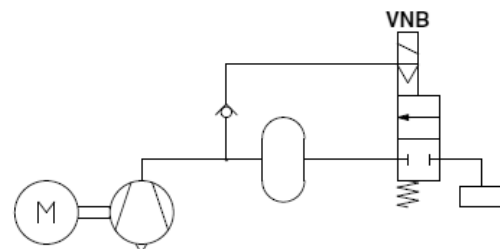



# VNB Troubleshooting

The shaded  indicates the case of the solenoid valve type.

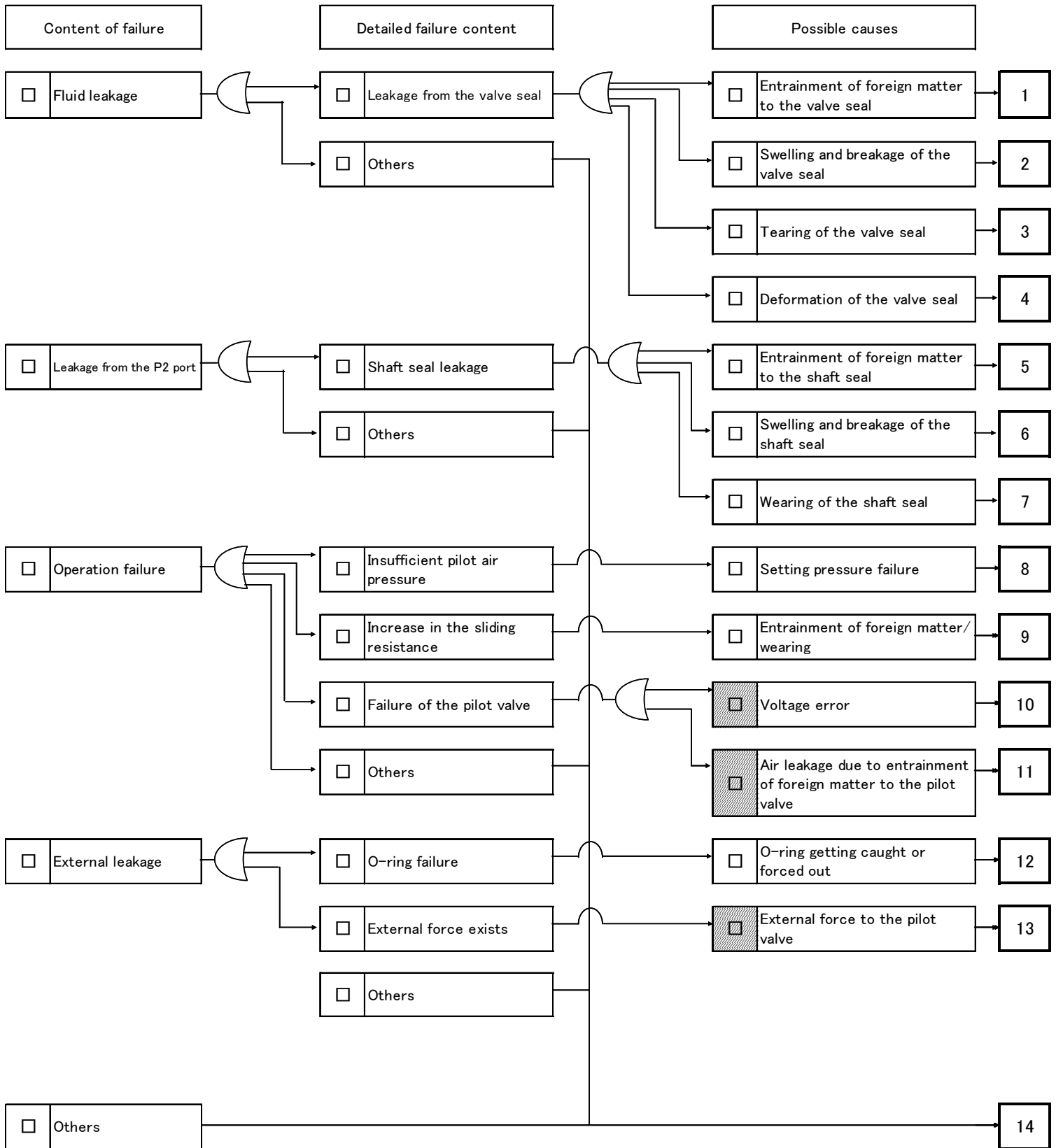

No.	How to check the cause	Troubleshooting
1	<input type="checkbox"/> Remove the cover assembly and check that no foreign matter is stuck to the valve seal.	<input type="checkbox"/> Foreign matter entered from outside might get stuck to the seal. <input type="checkbox"/> Take measures to prevent entrainment of foreign matter.
2	<input type="checkbox"/> Remove the cover assembly and check that there is no swelling and breakage of the valve seal.	<input type="checkbox"/> The rubber on the valve seal failed. <input type="checkbox"/> Check whether the fluid contains components which deteriorate the rubber of the main valve.
3	<input type="checkbox"/> Remove the cover assembly and check that there is no tearing on the rubber part of the valve seal.	<input type="checkbox"/> The adhesive strength of the rubber has reduced due to the effect of the fluid and atmosphere. <input type="checkbox"/> Perform maintenance as soon as possible or change the rubber material.
4	<input type="checkbox"/> Remove the cover assembly and check that there is no deformation of the rubber part of the valve seal.	<input type="checkbox"/> The rubber has deteriorated due to the effect of the fluid and atmosphere. <input type="checkbox"/> Perform maintenance as soon as possible or change the rubber material.
5	<input type="checkbox"/> Check that no foreign matter has entered the shaft seal of the plate.	<input type="checkbox"/> Foreign matter has entered from outside and got stuck to the seal. <input type="checkbox"/> Take measures to prevent entrainment of foreign matter.
6	<input type="checkbox"/> Check that there is no swelling and breakage on the shaft seal of the plate.	<input type="checkbox"/> The rubber on the shaft seal failed. <input type="checkbox"/> Check whether the fluid contains components which deteriorate the rubber of the main valve.
7	<input type="checkbox"/> Check that there is no abnormal wearing on the seal of the plate.	<input type="checkbox"/> The shaft seal failed because it was used for a long time and grease was running out. <input type="checkbox"/> Perform maintenance at an early stage by replacing the plate assembly.
8	<input type="checkbox"/> Check the pilot pressure.	<input type="checkbox"/> The setting pressure failed due to insufficient pilot pressure. <input type="checkbox"/> Adjust the pilot pressure within the operating pressure range.
9	<input type="checkbox"/> Check that there is no foreign matter stuck inside the valve.	<input type="checkbox"/> Foreign matter entered the valve and got stuck to the sliding part. <input type="checkbox"/> Take measures to prevent entrainment of foreign matter.
10	<input type="checkbox"/> Check that the voltage applied is within the operating specifications while the valve is energized.	<input type="checkbox"/> The pilot valve failed because the voltage applied was not within the operating range. <input type="checkbox"/> Check the voltage fluctuation and use the voltage within the operating range.
11	<input type="checkbox"/> Check that there is no air leakage from the P2 port. (in case of N.C)	<input type="checkbox"/> Foreign matter entered the pilot air piping and got inside the solenoid valve causing air leakage, leading to insufficient pilot pressure. <input type="checkbox"/> Take measures to prevent entrainment of foreign matter.
12	<input type="checkbox"/> Check for signs of the O-ring of the plate getting caught or forced out.	<input type="checkbox"/> The O-ring of the plate was caught in the body or cover during maintenance. <input type="checkbox"/> Assemble so that the O-ring of the plate is not caught during maintenance.
13	<input type="checkbox"/> Check for signs of external force having been applied to the pilot valve.	<input type="checkbox"/> External force was applied to the pilot valve. <input type="checkbox"/> Do not apply external force to the pilot valve.

14	<input type="checkbox"/> SMC will investigate. <div style="border-left: 1px solid black; border-right: 1px solid black; border-top: 1px solid black; border-bottom: 1px solid black; padding: 10px; margin: 10px 0;"> <p>The following information is required for investigation, so please send it to your sales representatives.</p> <ul style="list-style-type: none"> <li>- Detailed content of the failure</li> <li>- Operating cycle</li> <li>- Operating fluid</li> <li>- Machine used</li> <li>- Operating temperature</li> <li>- Fluid pressure</li> <li>- Pilot pressure</li> </ul> </div>
----	---------------------------------------------------------------------------------------------------------------------------------------------------------------------------------------------------------------------------------------------------------------------------------------------------------------------------------------------------------------------------------------------------------------------------------------------------------------------------------------------------------------------------------------------------------------------------------------------------------

Revision history		
<input type="checkbox"/> B	Renewal	PT
<input type="checkbox"/> C	Renewal	RP
<input type="checkbox"/> D	Renewal	RY

1st printing: -

## SMC Corporation

4-14-1, Sotokanda, Chiyoda-ku, Tokyo 101-0021 JAPAN

Tel: + 81 3 5207 8249 Fax: +81 3 5298 5362

URL <http://www.smcworld.com>

---

Note: Specifications are subject to change without prior notice and any obligation on the part of the manufacturer.  
© 2011 SMC Corporation All Rights Reserved