



No XL*****-OMI0014-B

First Edition: March,2005

Revised : November,2006

Operation Manual

High Vacuum L Type Valve

Model / Name

XLAV Series

Model / Series

Thank you for purchasing SMC product.
For appropriate operation of this product, please read this operation manual thoroughly to understand.
Also, refer to the drawing, product information for structure and specification of this product, Confirm operating environment is within specifications.
Keep this operation manual with care so that it can be used at any time.

Contents of this operation manual is subject to change without notice.

SMC CORPORATION

CONTENT

	Page
Safety Instructions.....	3
1. Precautions on handling 1.....	3
(Precautions on Design, Selection, Mounting, Piping, Maintenance)	
2. Precautions on handling 2.....	5
(Maintenance parts)	
3. Specifications.....	6
4. Construction and dimensions.....	7
5. Guaranteed term and guaranteed range.....	8
6. Replacement of part.....	9



Safety instructions

These safety instructions are intended to prevent a hazardous situation and/or equipment damage. These instructions indicate the level of potential by a label of “**Caution**”, “**Warning**” or “**Danger**”. To ensure safety, be sure to observe ISO 4411, JIS B 8300 and other safety practices.



Caution : Operator error could result in injury or equipment damage.



Warning : Operator error could result in serious injury of life.



Danger : In extreme conditions, there is a possible result of serious injury of loss life.

1. Precautions on handling 1



Common Specific Precautions 1 Be sure to read before handling.

This product (XLAV series) is equipped with a solenoid shifting valve. The solenoid shifting valve is 3-port solenoid valve SYJ300 or 500 series. Be sure to read Operation Manuals of this product and SYJ300 or 500 before use.

Precautions on Design



Warning

■ All models

- a) The body material is A6063, the bellows is SUS316L, and other metal seal material is SUS304. Standard seal material in the vacuum section is FKM that can be changed to the other materials (please refer “How to Order”). Use fluids those are compatible with using materials after confirming.
- b) Select materials for the actuation pressure piping, and heat resistance for fittings that are suitable for the applicable operating temperatures.

■ Models with auto switch

- a) The switch section should be kept at the temperature no greater than 50 °C.

Selection



Caution

■ All models

- a) When controlling valve responsiveness, take note of the size and length of piping, as well as the flow rate characteristics of the actuating solenoid valve.
- b) Actuating press should be kept within the specified range. 0.4 MPa to 0.5 MPa is recommended.
- c) Use within the limits of the operating pressure range.
- d) Keep residual voltage leakage not more than 3% of rated voltage for DC and 8% of rated voltage for AC.

Mounting

Caution

■ All models

- a) In high humidity environments, keep valves packed until the time of installation.
- b) In case with switches, secure the lead wires so that they have sufficient slack, without any unreasonable force applied to them.
- c) Perform piping so that excessive force is not applied to the flange sections. In case there is vibration of heavy objects or attachments, secure them so that torque is not applied directly to the flanges.

Piping

Caution

- a) Before mounting, clean the surface of the flange seal and the O-ring with ethanol, etc.
- b) There is an indentation of 0.1 to 0.2mm in order to protect the flange seal surface, and it should be handled so that the seal surface is not damaged in any way.

Wiring

Caution

- a) When connecting power to a DC specification solenoid valve equipped with (light/) surge voltage suppressor, confirm whether or not there is polarity.
If there is polarity, take note of the following points.
No diode to protect polarity: if a mistake is made regarding polarity, the diode in the Valve, the control device switching element or power supply equipment, etc., may burn out.
With diode to protect polarity: if polarity connection is wrong, the valve does not switch.
- b) When electric power is connected to a solenoid valve, be careful to apply the proper voltage. Improper voltage may cause malfunction or coil damage.
- c) After completing the wiring, confirm that the connections are correct.

Maintenance

Warning

If the fluid or reaction product (deposit) may deteriorate safety, those who have domain knowledge and experience (specialist of the field) shall disassemble, clean and assemble the products.

Caution

- a) When removing deposits from a valve, take care not to damage any of its parts.
- b) Replace the bonnet assembly when the end of its service life is approached.
- c) If damage is suspected prior to the end of the service life, perform early maintenance.
- d) SMC specified parts should be used for service. Refer to the Construction / Maintenance parts table.
- e) When removing valve or exterior seals, take care not to damage the sealing

surfaces. When installing the valve seal, be sure that the O-ring is not twisted.

2. Precautions on handling 2



Common Specific Precautions 2

Maintenance Parts

Be sure to read before handling



Caution

The bonnet assembly should also be replaced when changing the seal material. Due to the different materials used, changing only the seal may prove inadequate.

Bonnet assembly/construction part number:1

Temperature specifications	Indicator	Valve size			
		16	25	40	50
General use	without	XLAV16-30-1	XLAV25-30-1	XLAV40-30-1	XLAV50-30-1
	with	XLAV16A-30-1	XLAV25A-30-1	XLAV40A-30-1	XLAV50A-30-1

Temperature specifications	Indicator	Valve size			
		63	80	100	160
General use	without	XLAV63-30-1	XLAV80-30-1	XLAV100-30-1	XLAV160-30-1
	with	XLAV63A-30-1	XLAV80A-30-1	XLAV100A-30-1	XLAV160A-30-1

Note 1) List the optional seal material symbol after the model number, except for the standard seal material (FKM: compound No. 1349-80).

Exterior seal, valve seal

Description Constructions No.	Material	Valve size			
		16	25	40	50
Exterior seal 3	Standard	AS568-025V	AS568-030V	AS568-035V	AS568-039V
	Specific	AS568-025 **	AS568-030 **	AS568-035 **	AS568-039 **
Valve seal 2	Standard	B2401-V15V	B2401-V24V	B2401-P42V	AS568-227V
	Specific	B2401-V15 **	B2401-V24 **	B2401-P42 **	AS568-227 **

Description Construction No.	Material	Valve size			
		63	80	100	160
Exterior seal 3	Standard	AS568-043V	AS568-045V	AS568-050V	AS568-167V
	Specific	AS568-043 **	AS568-045 **	AS568-050 **	AS568-167 **
Valve seal 2	Standard	AS568-233V	B2401-V85V	AS568-349V	B2401-G155V
	Specific	AS568-233 **	B2401-V85 **	AS568-349 **	B2401-G155 **

Note 2) List the optional seal material symbol after the model number, except for the standard seal material (FKM: compound no. 1349-80).

Note 3) Refer to the Construction of each series for the construction numbers.

Optional seal material

Seal material	EPDM	Barrel Perfluoro®	Kalrez®	Chemraz®			VMQ	FKM for PLASMA	ULTIC ARMOR®
Compound NO.	2101-80	70W	4079	SS592	SS630	SSE38	1232-70	3310-75	UA4640
Symbol	-XN1	-XP1	-XQ1	-XR1	-XR2	-XR3	-XS1	-XT1	-XU1

Note 4) Due to the different materials used, changing only the seal may prove inadequate.

Barrel Perfluoro® is a registered trademark of the Matsumura Oil Co.,Ltd. .

Kalrez® is a registered trademark of the Dupont Dow Elastomers .

Chemraz® is a registered trademark of the Greene,Tweed & Co. .

ULTIC ARMOR® is a registered trademark of the NIPPON VALQUA INDUSTRIES,LTD.

3. Specifications

Model	XLAV-16	XLAV-25	XLAV-40	XLAV-50	XLAV-63	XLAV-80	XLAV-100	XLAV-160
Flange (valve) size	16	25	40	50	63	80	100	160
Actuating type	Normally closed							
Fluid	Vacuum of inert gas							
Operating temperature °C	5 to 50							
Operating pressure Pa	Atmospheric pressure to 1×10^6							
Conductance l/s Note 1	5	14	45	80	160	200	300	800
Leakage Pa·m ³ /s	Internal	1.3 x 10 ⁻¹⁰ for the standard material (FKM) at ambient temperatures, excluding gas permeation						
	External	1.3 x 10 ⁻¹¹ for the standard material (FKM) at ambient temperatures, excluding gas permeation						
Flange type	KF (NW)				KF (NW), K (DN)			
Main material	Body: aluminum alloy, Bellows: SUS316L, Main part: SUS304 and FKM (standard sealing material)							
Surface treatment for body	Outside: hard anodized Inside: basis material							
Actuation pressure MPa	0.4~0.7							
Air consumption cm ³ Note 2 for 0.5MPa	19	46	200	360	660	1350	3000	5150
Port size	M5				1(SUP) port :Rc 1/8, 3(EXH) port :M5			
Weight kg	0.29	0.49	1.14	1.64	2.96	5.06	10.7	18.6

Note 1 The conductance is "molecular flow" measured with an elbow pipe which has the same dimension with each flange.

Note 2 Air consumed by a reciprocating motion of a cylinder.

Operating solenoid shifting valve is SYJ319-** for XLAV-16, 25, 40 and 50
and SYJ519-** for XLAV-63, 80, 100 and 160.

For further details on solenoid valve, refer to the SMC solenoid valve catalog "SYJ300,500".

4. Construction/ Dimensions

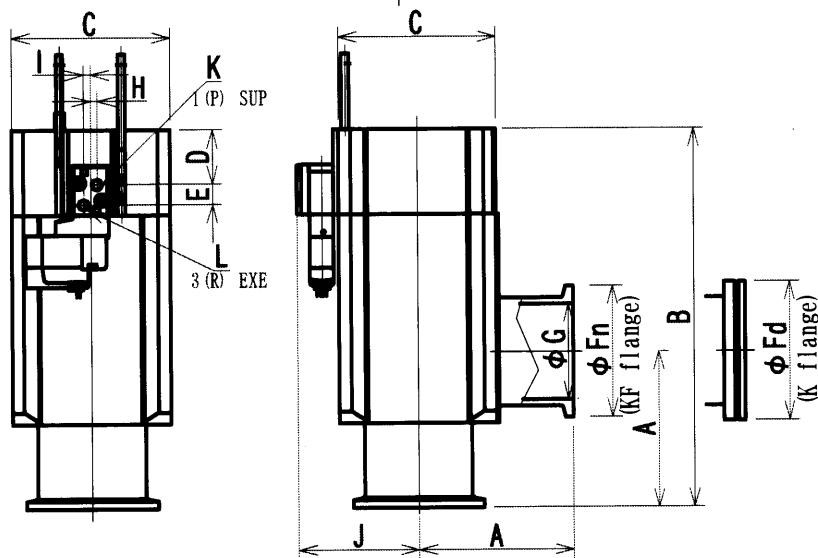
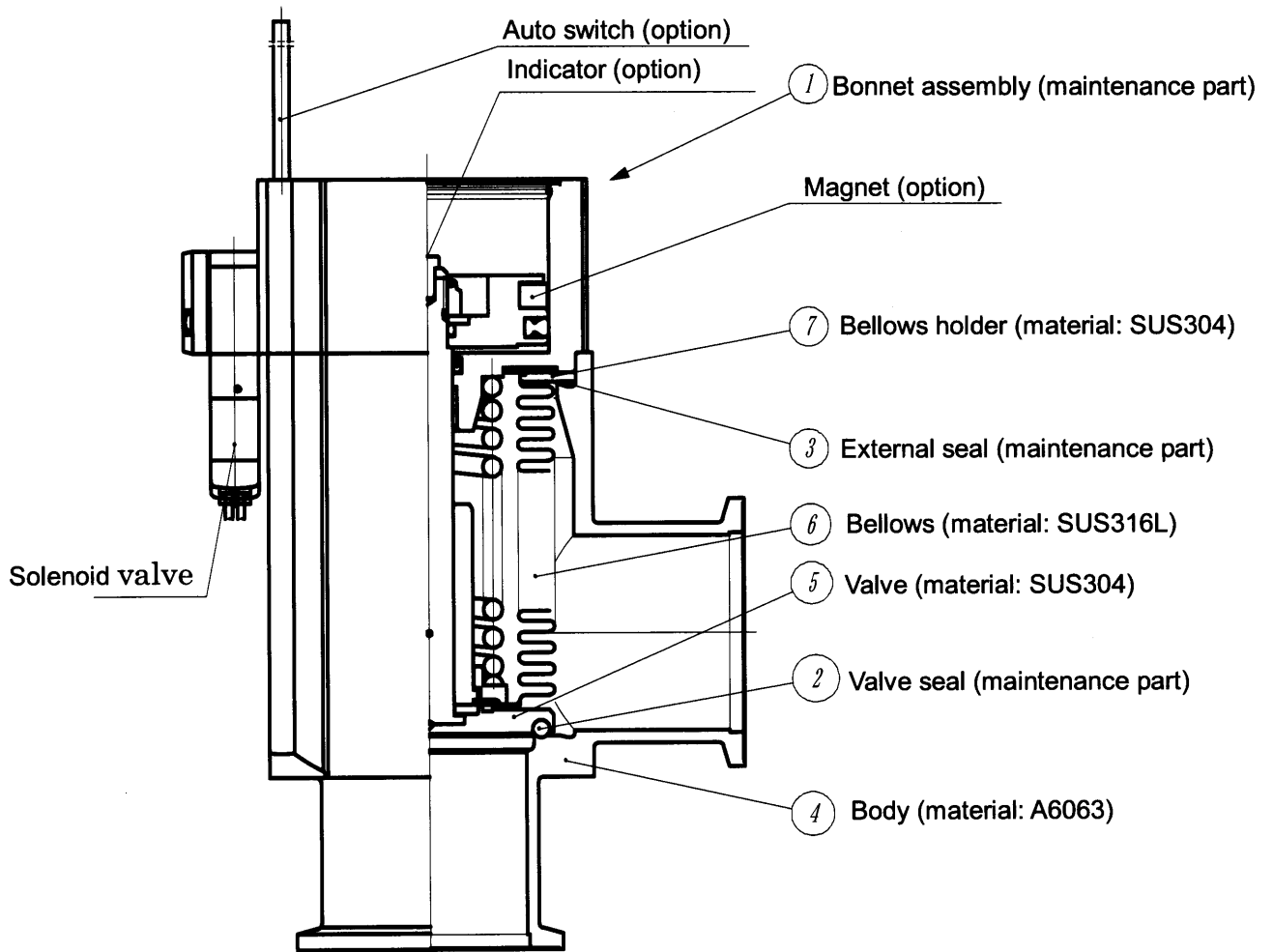

Model	A	B	C	D	E	Fn	Fd	G	H	I	J	K	L
XLAV-16	40	103	38	13.4	8.5	30	-	17	2.7	3	35.5	M5	M5
XLAV-25	50	113	48	14.9	8.5	40	-	26	2.7	3	40.5	M5	M5
XLAV-40	65	158	66	22.7	8.5	55	-	41	2.7	3	50.5	M5	M5
XLAV-50	70	170	79	25.7	8.5	75	-	52	2.7	3	57	M5	M5
XLAV-63	88	196	100	28.7	12	87	95	70	4	2	78.5	1/8"	M5
XLAV-80	90	235	117	38.7	12	114	110	83	4	2	87	1/8"	M5
XLAV-100	108	300	154	50.7	12	134	130	102	4	2	105.5	1/8"	M5
XLAV-160	138	315	200	57.7	12	190	180	153	4	2	128.5	1/8"	M5

5. Guaranteed period and range

The guaranteed period covers the period which finishes the earliest among 2 million operating cycles (for size 16 to 80) or 1 million operating cycles (for size 100 and 160) [with our durability test conditions], 18 months after shipping from us, and 12 months after starting the use of the product at your place or your customer's place.

Note: The product durability is varied depending on the operating conditions (such as a use with large flow rate).

If the specification is not kept, or any non-conformance derived from mounting or replace of a device, an assembly, or an O-ring at your place occurs, the guarantee cannot be applied.

If any failure occurs due to our fault during the guaranteed period, we will guarantee the non-conformance by delivering a substitute in the worst case. However, responsibility of any damage which is led by the product failure is not taken by us.

Result of durability test (with the circuit shown on the right)

Internal/ external leakage and operation were checked by opening and closing a valve in internally evacuated condition at ordinary temperature (room temperature).

It was confirmed that XLAV-16, XLAV-25, XLAV-40, XLAV-50, XLAV-63 and XLAV-80 satisfied the product specification up to 2 million cycles, XLAV-100 and XLAV-160 did up to 1 million cycles.

The test was performed with FKM, the standard sealing material.

<Reference>

The pumping direction is not limited, but if the pumping creates a flow stream, the durability of the product could be impaired.

Therefore, the pumping direction shown on the right figure (bellows side pumping) is recommended.

Also, the operating conditions should be checked beforehand because it affects the life.

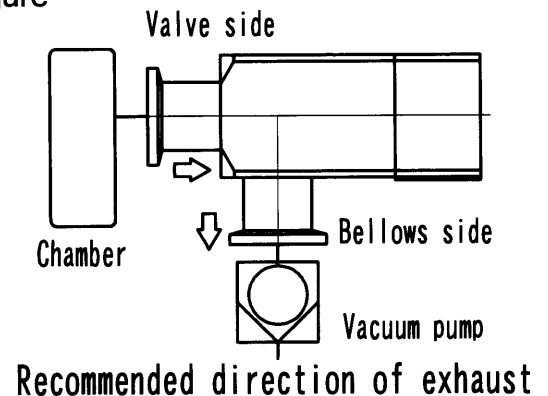
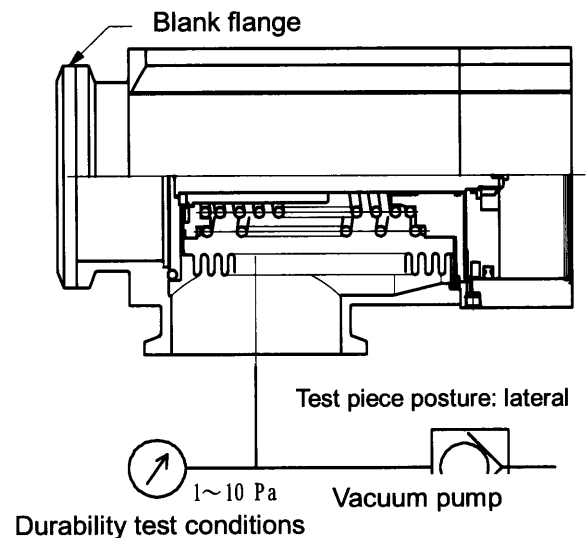

6. Replacement of part

The figure below shows XLA (air operated valve), but the replacement procedure is the same.

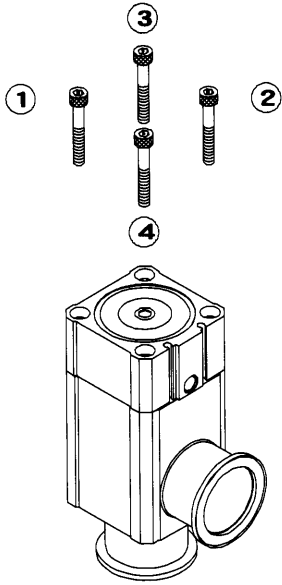
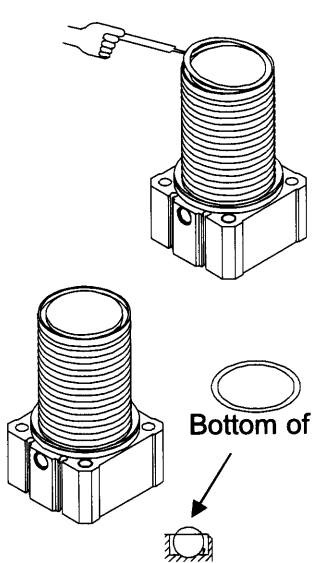
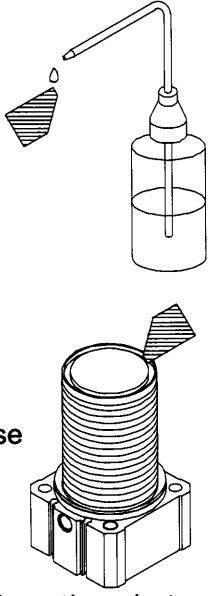
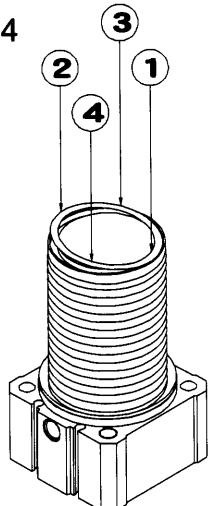
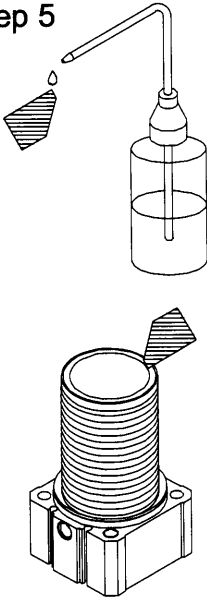
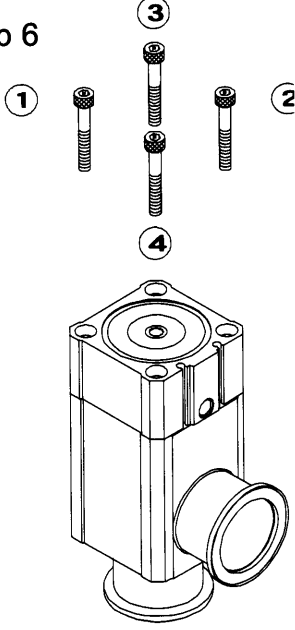
Valve Seal (O-ring) replacement procedure			
Dept.	1	Model	High Vacuum Angle Valve
Step 1	Step 2		Step 3
 <p>Supply 0.4Mpa of pressure to the port1(P)SUP and loosen bolts gently in numerical order.</p>	 <p>Remove O-ring from the gas release groove with a tool which height is the same as the groove depth. (Mind not to damage O-ring groove)</p>		 <p>Apply ethanol to clean paper to wipe off the dust in O-ring groove. (Ensure no fiber nor dust are found)</p>
Step 4	Step 5	Step 6	
 <p>Apply ethanol to clean paper to wipe off dust on O-ring surface, and place the ring to O-ring groove. Press O-ring in numerical order in above drawing (press diagonally) to mount O-ring into the groove. (Put on gloves which generate no particle)</p>	 <p>Apply ethanol to clean paper to wipe off dust on O-ring surface.</p>	 <p>Supply 0.4Mpa of pressure to the port1(P)SUP to tighten bolts in numerical order in above drawing. First, hand tighten them evenly until just before O ring is squeezed. Then, tighten them altogether.</p>	

The figure below shows XLA (air operated valve), but the replacement procedure is the same.

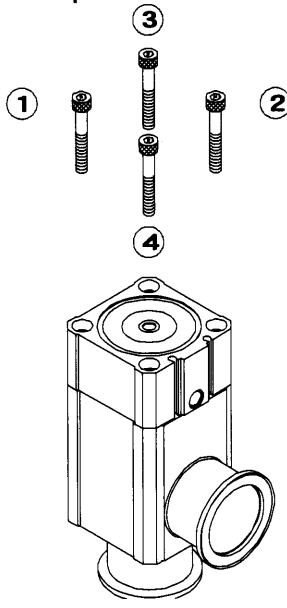
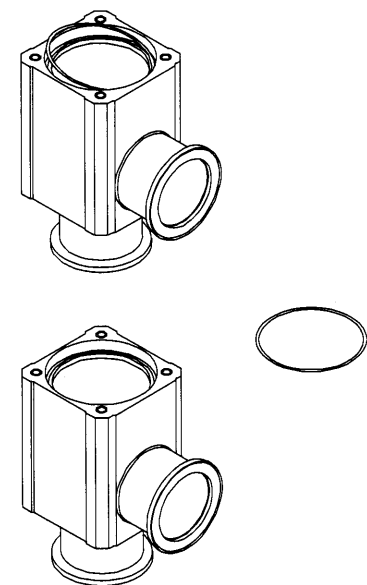
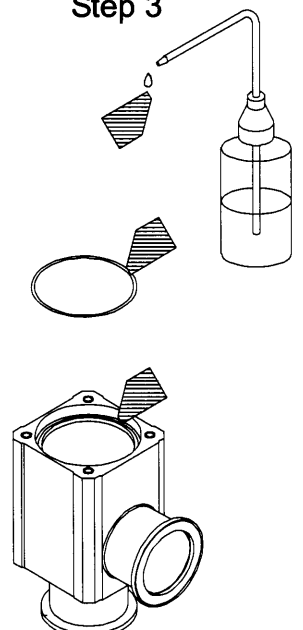
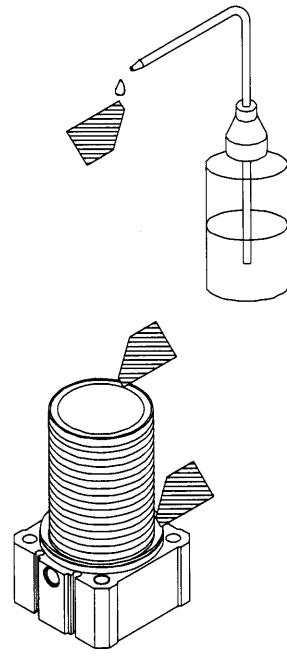
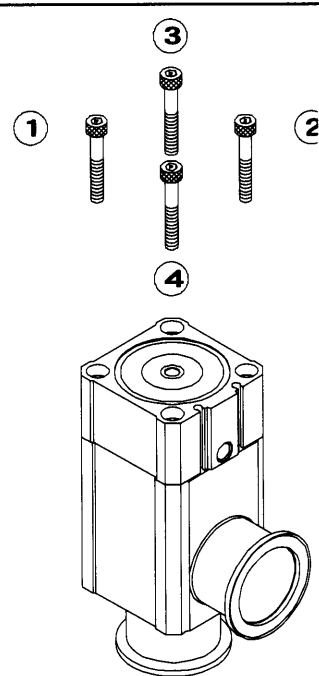
Exterior Seal (O-ring) replacement procedure			
Dept.	1	Model	High Vacuum Angle Valve
<p>Step 1</p>  <p>Supply 0.4Mpa of pressure to the port1(P)SUP and loosen bolts in numerical order.</p>		<p>Step 2</p>  <p>Remove O-ring from the body. (Mind not to damage the body mount surface.)</p>	
		<p>Step 3</p>  <p>Apply ethanol to clean paper to wipe off the dust on O-ring surface and the body mount surface. Then, mount the O-ring.</p>	
<p>Step 4</p>  <p>Apply ethanol to clean paper to wipe off dust on O-ring surface and bellows holder surface.</p>		<p>Step 5</p>  <p>Supply 0.4Mpa of pressure to the port1(P)SUP to tighten bolt in numerical order in above drawing. First, hand tighten them evenly until just before O ring is squeezed. Then, tighten them altogether.</p>	