

# Digital Pressure Switch Operation Manual



ZSE80(F)/ISE80(H)

Thank you for purchasing an SMC ZSE80(F)/ISE80(H) Series Digital Pressure Switch.

Please read this manual carefully before operating the product and make sure you understand its capabilities and limitations.  
Please keep this manual handy for future reference.

To obtain more detailed information about operating this product, please refer to the SMC website (URL <http://www.smcworld.com>) or contact SMC directly.

## Safety Instructions

These safety instructions are intended to prevent hazardous situations and/or equipment damage.

These instructions indicate the level of potential hazard with the labels of "Caution", "Warning" or "Danger". They are all important notes for safety and must be followed in addition to International standards (ISO/IEC) and other safety regulations.

**Caution:** CAUTION indicates a hazard with a low level of risk which, if not avoided, could result in minor or moderate injury.

**Warning:** WARNING indicates a hazard with a medium level of risk which, if not avoided, could result in death or serious injury.

**Danger:** DANGER indicates a hazard with a high level of risk which, if not avoided, will result in death or serious injury.

## Operator

- This operation manual is intended for those who have knowledge of machinery using pneumatic equipment, and have sufficient knowledge of assembly, operation and maintenance of such equipment. Only those persons are allowed to perform assembly, operation and maintenance.
- Read and understand this operation manual carefully before assembling, operating or providing maintenance to the product.

## Safety Instructions

### Warning

Do not disassemble, modify (including changing the printed circuit board) or repair. An injury or failure can result.

Do not operate the product outside of the specifications. Do not use for flammable or harmful fluids. Fire, malfunction, or damage to the product can result. Verify the specifications before use.

Do not operate in an atmosphere containing flammable or explosive gases. Fire or an explosion can result. This product is not designed to be explosion proof.

Do not use the product in a place where static electricity is a problem. Otherwise it can cause failure or malfunction of the system.

If using the product in an interlocking circuit:  
Provide a double interlocking system, for example a mechanical system  
Check the product regularly for proper operation  
Otherwise malfunction can result, causing an accident.

The following instructions must be followed during maintenance:  
Turn off the power supply  
Stop the air supply, exhaust the residual pressure and verify that the air is released before performing maintenance work  
Otherwise an injury can result.

### Caution

Do not touch the terminals and connectors while the power is on. Otherwise electric shock, malfunction or damage to the product can result.

After maintenance is complete, perform appropriate functional inspections and leak tests. Stop operation if the equipment does not function properly or there is a leakage of fluid. When leakage occurs from parts other than the piping, the product might be faulty. Disconnect the power supply and stop the fluid supply. Do not apply fluid under leaking conditions. Safety cannot be assured in the case of unexpected malfunction.

## NOTE

- The direct current power supply to be used should be UL approved as follows: Circuit (of Class2) which is of maximum 30 Vrms (42.4 V peak), with UL1310 Class2 power supply unit or UL1585 Class2 transformer.
- The product is a approved product only if it has a mark on the body.

## Summary of Product parts

### Names of individual parts

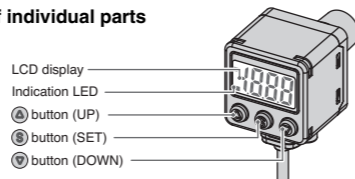

- Indication LED (orange): Displays the switch condition.  
LCD display: Displays the current status of pressure, setting mode, selected indication unit and error code.  
Four display modes can be selected: display always in red or green, or display changing from green to red, or red to green, according to the output status.
- button (UP): Selects the mode or increases ON/OFF set value. Press this button to change to the peak display mode.
  - button (DOWN): Selects the mode or decreases ON/OFF set value. Press this button to change to the bottom display mode.
  - button (SET): Press this button to change to another mode and to set a value.

## Mounting and Installation

### Installation

#### Mounting

- Mount the optional bracket and panel mount adapter to the Pressure switch.
- When the Pressure switch is to be mounted in a place where water and dust splashes occur, insert a tube (O.D  $\phi$ 4, I.D  $\phi$ 2.5) into the air-relieving port of the Pressure switch.
- Mounting with bracket
  - Fix the bracket to the Pressure switch with the set screws M3 x 5 L (2 pcs.) supplied.
  - Apply a tightening torque of 0.98 Nm or less.
    - Rear piping ... Bracket A (Model: ZS-24-A)
    - Bracket D (Model: ZS-24-D)
    - Bottom piping ... Bracket B (Model: ZS-35-A)

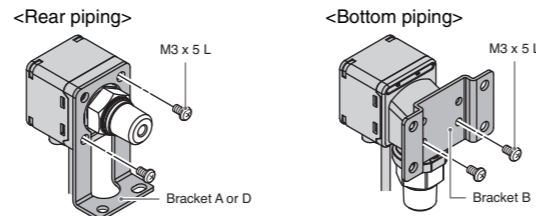

#### Mounting with panel mount adapter

- Panel mount adapter (Panel mount adapter A, B and mounting bracket included)
  - Rear piping ... Model: ZS-35-C
  - Bottom piping ... Model: ZS-35-B
- Panel mount adapter + Front protective cover
  - Rear piping ... Model: ZS-35-F
  - Bottom piping ... Model: ZS-35-E

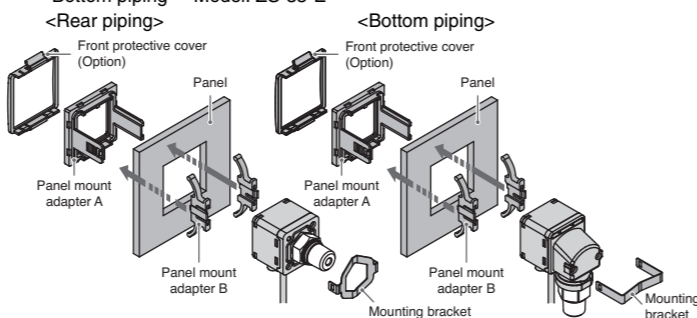

Refer to the product catalogue or SMC website (URL <http://www.smcworld.com>) for more information about panel cut-out and mounting hole dimensions.

### Piping

#### Connection using screw type fitting

- Connect suitable piping to the port.
- To connect the hexagon socket head plug or fitting to the pressure port, hold the hexagon part of the pressure port with a suitable spanner. Apply a tightening torque of 13.6 Nm or less.

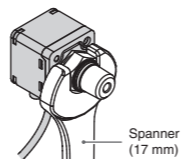

#### Tube attachment

- When the Pressure switch is used in a place where water and dust splashes may occur, insert a tube into the air-relieving port and route the other end of the tube to a safe place away from water and dust. (See the figure below)

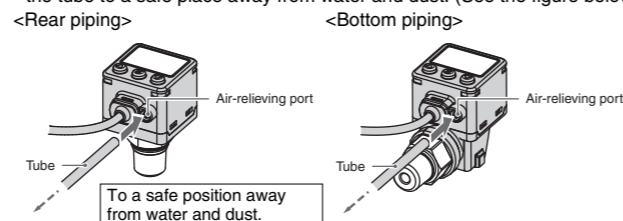

- Insert the tube into the air-relieving port until it bottoms out.
- SMC TU0425 (polyurethane, O.D  $\phi$ 4, I.D  $\phi$ 2.5) is a suitable tubing.

## Wiring

### Connection

- Connections should only be made with the power supply turned off.
- Use separate routes for the Pressure switch wiring and any power or high voltage wiring. Otherwise, malfunction may result due to noise.
- Ensure that the FG terminal is connected to ground when using a commercially available switch-mode power supply. When a switch-mode power supply is connected to the product, switching noise will be superimposed and the product specification can no longer be met. This can be prevented by inserting a noise filter, such as a line noise filter and ferrite core, between the switch-mode power supply and the product, or by using a series power supply instead of the switch-mode power supply.

Brown	DC(+)
Grey	Analogue output / Auto-shift input
Black	OUT1
White	OUT2
Blue	DC(-)

## Pressure Setting

### Measurement mode

The measurement mode is the condition where the pressure is detected and indicated, and the switch function is operating. This is the basic mode, and the other modes should be selected for setting changes and other function settings.

Set ON and OFF point of the Pressure switch. Operation (Hysteresis mode)

When the pressure exceeds the set value, the Pressure switch will turn ON. When the pressure falls below the set value by the amount of hysteresis or more, the Pressure switch will turn OFF. The default setting of the output set value is the central value between the atmospheric pressure and the upper limit of the rated pressure range. If this condition, shown to the right, is acceptable, then keep these settings.

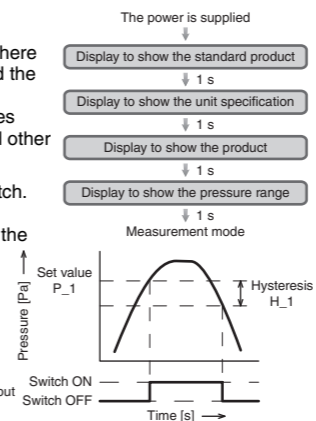

<How to operate> \*: The Pressure switch will also output during setting.

- Press the button once in measurement mode.

- [P\_1] or [n\_1] and set value are displayed in turn.

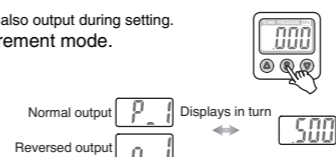

- Press the or button to change the set value.

The is to increase and the button is to decrease.

- Press the button once to increase by one digit, and press it continuously to keep increasing the set value.

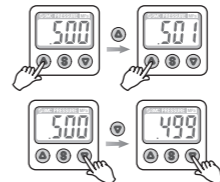

- Press the button once to decrease by one digit, and press it continuously to keep decreasing the set value.

- Press the button to complete the setting. For models with 2 outputs, [P\_2] or [n\_2] will be displayed. Set as above. \*: If the button is pressed for 2 seconds or longer, the setting is fixed and measurement mode returns.

The Pressure switch operates within a set pressure range (from P1L to P1H) during window comparator mode. Set P1L (switch lower limit) and P1H (switch upper limit) with the setting procedure above. (When reversed output is selected, [n1L] and [n1H] are displayed.)

### Zero clear of display

The display is reset to zero when the and buttons are pressed simultaneously for 1 second. For the initial operation, always perform zero clear with no pressure applied.

## Function Setting

### Function selection mode

In measurement mode, press the button for 2 seconds or longer to display [F 0]. Select to display the function to be changed, [F□□]. Press the button for 2 seconds or longer in function selection mode to return to measurement mode.

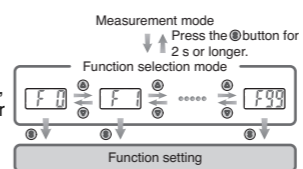

\*: Some functions are not available depending on part number. All functions are displayed with [F□□] followed by the function description. If a function is not available, the function is displayed as [---].

### Default setting

At the time of shipment, the following settings are provided. If the setting is acceptable, keep it for use.

Refer to the SMC website (URL <http://www.smcworld.com>) for more detailed information about setting changes, or contact SMC.

#### [F 0] Unit conversion function

Unit specification	Model	Default setting	Unit specification	Model	Default setting
Nli or M	ISE80(H)	MPa	p	ISE80(H)	psi
	ZSE80(F)	kPa		ZSE80(F)	

### [F 1] Setting of OUT1

Item	Description	Default setting
Output mode	Selects hysteresis mode or window comparator mode.	Hysteresis mode
Reversed output	Selects reversed output.	Normal output
Pressure setting	Sets ON or OFF point of the switch output.	ISE80: 0.500 MPa ZSE80: -50.0 kPa ISE80H: 1.000 MPa
Hysteresis	Chattering can be prevented by setting hysteresis.	ISE80: 0.050 MPa ZSE80: 5.0 kPa ISE80H: 0.100 MPa
Display colour	Selects the display colour.	ON: Green / OFF: Red

### [F 2] Setting of OUT2

Same setting as [F 1] OUT1. The display colour is linked to the setting of OUT1, and can not be set for OUT2.

### Other parameter setting

Item	Default setting
[F 3] Setting of response time	2.5 ms
[F 4] Setting of analogue output / auto-shift input	Analogue output
[F 5] Setting of display resolution	1000-split
[F 7] Setting of fine adjustment of display value	0%
[F 8] Setting of auto-preset	Manual
[F 9] Setting of power saving mode	OFF
[F10] Setting of security code	OFF
[F98] Setting of all functions	OFF
[F99] Reset to the default setting	OFF

## Other Settings

### Peak / Bottom hold display

### Zero clear

### Key lock

To set each of these functions, refer to the SMC website (URL <http://www.smcworld.com>) for more detailed information, or contact SMC.

## Maintenance

### How to reset the product after a power cut or forcible de-energizing

The setting of the product will be retained as it was before a power cut or de-energizing. The output condition is also basically recovered to that before a power cut or de-energizing, but may change depending on the operating environment. Therefore, check the safety of the whole installation before operating the product. If the installation is using accurate control, wait until the product has warmed up (approximately 10 to 15 minutes).

## Troubleshooting

### Error Indication

This function is to display error location and content when a problem or an error occurs.

Error name	Error display	Error type	Troubleshooting method
Over current error	Er1 Er2	The switch output load current is more than 80 mA.	Turn the power off and remove the cause of the over current. Then turn the power on.
Residual Pressure error	Er3	During the zero clear operation, pressure above $\pm$ 10% of the span between atmospheric pressure and the upper limit of rated pressure has been applied. After 1 second, the mode will return to measurement mode. The zero clear range can vary $\pm$ 1 digit with individual product differences.	Perform zero clear operation again after restoring the applied pressure to an atmospheric pressure condition.
Pressurizing error	HHH LLL	Pressure has exceeded the upper limit of the set pressure range. Pressure has exceeded the lower limit of the set pressure range.	Reset applied pressure to a level within the set pressure range.
Auto-shift error	Or	The measured pressure at auto-shift input exceeded the set pressure range. *: After 1 s, measurement mode returns automatically.	Auto-shift input signal is invalid. Check the connected equipment and correct the signal.
System error	Er4 Er6 Er7 Er0	Displayed in the case of an internal data error.	Turn the power off and turn it on again. If resetting fails, an investigation by SMC Corporation will be required.

If the error can not be reset after the above measures are taken, then please contact SMC.

Refer to the SMC website (URL <http://www.smcworld.com>) for more information about troubleshooting.

## Specifications Outline with Dimensions (in mm)

Refer to the product catalogue or SMC website (URL <http://www.smcworld.com>) for more information about the product specifications and outline dimensions.

SMC Corporation URL <http://www.smcworld.com>

Akihabara UDX 15F, 4-14-1, Sotokanda, Chiyoda-ku, Tokyo 101-0021, JAPAN  
Phone: +81 3-5207-8249 Fax: +81 3-5298-5362

Note: Specifications are subject to change without prior notice and any obligation on the part of the manufacturer. © 2011 SMC Corporation All Rights Reserved